

# DIGITAL MANUFACTURING *in Primary Education*



TAD

Tangible Aided Design

Petrit Holmgaard Gerxhaliu AHO 2017

**Petrit Holmgaard Gerxhaliu**  
**Institute: Design**  
**Field: Product design, interaction design**  
**Main supervisor: Steinar Killi Secondary**  
**supervisor: Nick Stevens**  
**Collaborative partner: Roland DG User**  
**collaboration: Idd Skole**



## Content

### **Executive summary**

**Situation 7**

**Motivation 8**

**Collaboration 9**

### **Analysis and research**

**Introduction 12**

**The teachers role 13**

**The children 15**

**Tilling process 16**

**Analysis cam 18**

**Analysis cnc 20**

**The different levels of teaching goals 22**

**Field research 24**

**The problem with thingiverse 26**

### **Synthesis and concept development**

**Introduction 30**

**G-blocks 32**

**Voxels 34**

**Needle pin 37**

### **Development of final concept**

**Introduction 40**

**Functional prototype 42**

**User testing 44**

**Organizing of pins and resolution 46**

**Moodboard and inspiration 48**

**Shape exploration 50**

**Modeling 52**

**TAD 54**

**Functions 66**

**Shape 70**

**Removing user error 72**

**Designing with a physical connection 74**

**Conclusions and reflections 76**

**Appendix 77**

**Creation 78**

**Sources 80**

## Executive Summary

---

# TAD - Tangible Aided Design

TAD is the result of an explorative process, where the goal was to create a way for children in primary education to use and develop their skills in digital manufacturing.

Through contextual research, video sketching, iterative prototyping and continuous user testing, the solution has evolved from the operations of the CNC-machine to a tool for creating 3D models for both additive and subtractive processes.

The end result is a tangible modeling tool, which creates 1:1 3D-files, in the maximum format of 120\*100\*35mm, ready for either milling or printing on the go.

Tad uses the basic principle of every modeling tool, cut and extrude, by registering how far you push the pins in it 35mm travel. Since the final model is represented on the top of the product, you also have the negative imprint at the bottom. That allows for reproducing finished models, or modify them according to need. In that way, it works like a low resolution scanner. Modelling complex surfaces is one of the cruxes of almost all existing CAD-software. TAD has over 1000 points of measurement along the 35mm long Z-axis, allowing for fine sculpturing across the whole surface.

This diploma hopes to lower the threshold for using digital manufacturing methods in primary education, and also teaches the basic modelling technique. This might enhance their interest within practical fields, both in school and on a hobby basis.

There are none similar solutions on the market at the moment, so the competitiveness of TAD is also hard to measure. But the feedback has been good on the functional scale model.

The visuals of TAD represents that it's an object that's supposed to be gripped, lifted and manipulated. It relies on physical manipulation to create an output, so the controls have been kept to a minimum, and all have to be manipulated by hand.

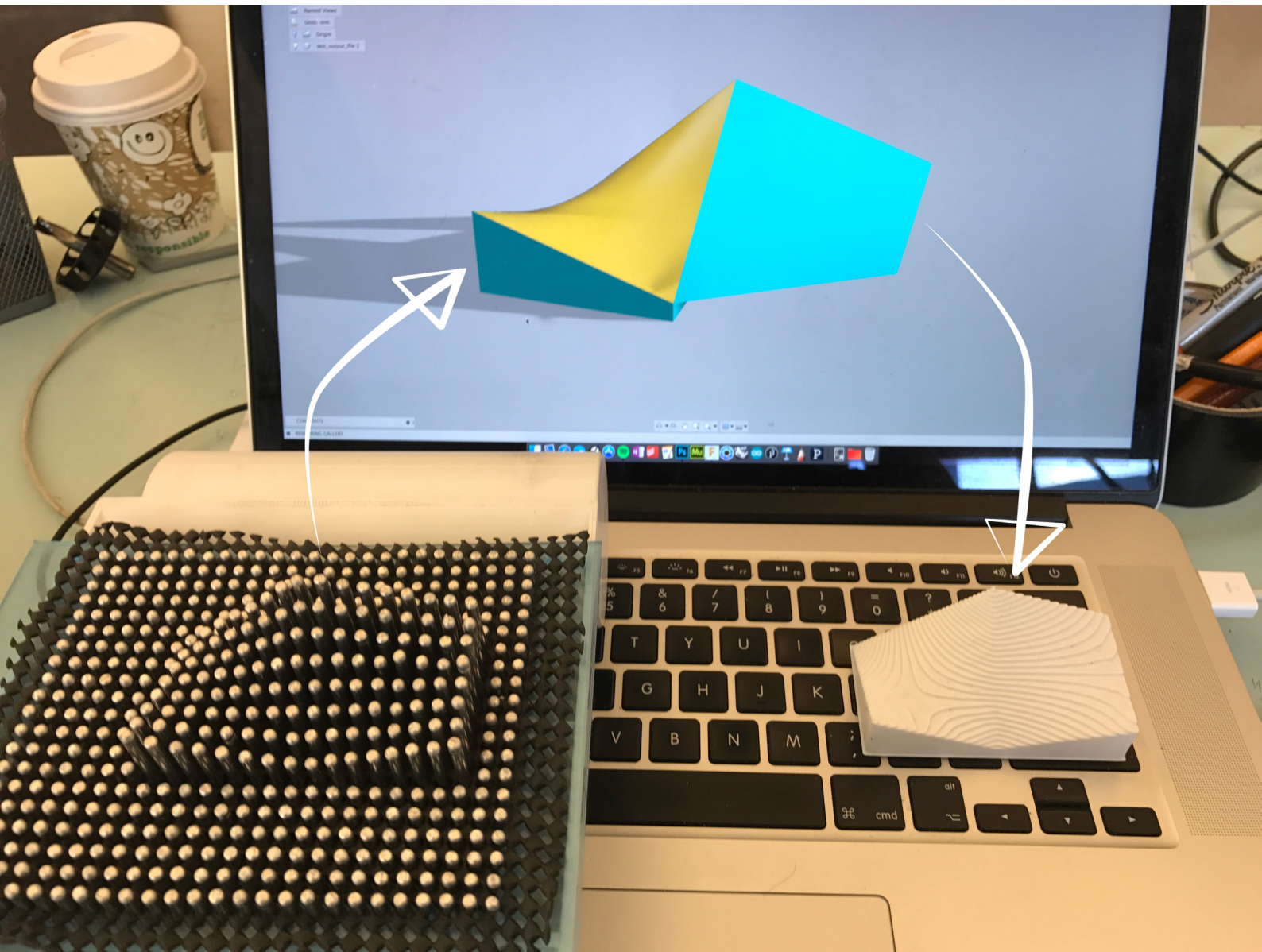

# Introduction

---

The future belongs to the children, and Norway is investing heavily in both their education and in innovation and technology. Their first experience with a creative subject is often in the woodworking class at primary school. The tools the children encounter are typically woodworking tools like hammers, saws and drills.

This project will look at how new digital fabrication tools can be integrated into the workshops of primary schools. The DIY-movement has showed that even people who are relatively amateurs, can quickly learn how to make their own designs, as opposed to ready made, downloaded objects. By bringing the next generation of 21st century tools into the traditional primary school workshops, this project aims to inspire the next generation of creators.

The delivery will be a mock up of a functional model, a visual non-functional prototype and the rapport. As this is an explorative project in a field where there exist none to a few actual solutions, I will hopefully be evaluated on the concept, and not purely on Interaction Design or Product Design. In addition I will not create a refined visual profile or user interface.

## The situation

Once a week, every week for 10 years, Norway's children visit the workshop for a class teaching them practical skills. Summed up, that's approximately 800 hours. That's a lot of time, but less than the 10000 hours needed to become an expert in a field, as stated by Gladwell (Gladwell, 2008). The government states in a proposal from 2015 that:

“...the future of practical aesthetically subjects must be strengthened in the school of the future. This is also welcomed by both the individual schools and corporate businesses.” (Kunnskapsdepartementet, 2016)

Considering the time a child spends in woodworking class, the arts and crafts level in Norwegian primary education ought to be quite high. Some excerpts from the competence aims in the plan for wood working classes in the Norwegian primary education (Læreplan i kunst og håndverk (KHV1-01), no date) are;

- **Create functional products og evaluate the quality of own work**
- **Explore different solutions of the design of a product by means of sketches and digital software**
- **Design products from a demand specification for form and function**
- **Create simple functional forms in different materials and explain the coherence between idea, selection of materials, techniques, shape, colour and function**
- **Evaluate the design and industrial production of known functional items from everyday life and perform simple function tests**

If these aims are being met in today's schools, then the future of entrepreneurial endeavours looks bright. I do have some scepticism though, because even at master level at AHO, some adult students don't think they master all of these goals.

At the moment, Norway is shifting focus from the slowly decaying oil-industry towards potential new areas for value-creation (Therkelsen and Therkelsen, 2014). The leader of Innovation Norway, Anita Krohn Traaseth, says:

“Nå skal vi heie fram de nye gründerne som skal bygge nye industrier.”

At the same time, we're facing a future where the environment and overpopulation is becoming increasingly important (Guggenheim, 2006). Together, this information underlines the growing focus on arts and crafts in primary education, and how it could impact the future industries of Norway.

## **My motivation**

Designing and making simple objects has always given me a feeling of accomplishment. When I look back to my years in the woodworking class during the primary education, one thing that springs to mind is that everyone made the same object. That means that every parent in my neighbourhood has copies of my cuttingboards, my knitted balsa-wood pots and my boxes engraved with soldering gun, albeit with a different engraving and color.

During the five years at the Oslo School of Architecture and Design, digital manufacturing has intrigued me. The machines can create almost any three dimensional shape, but creating the form and preparing it for milling or printing is usually where the difficulty comes. Think double curved surfaces in Solidworks, which is both an industrial standard and the default software in our education. Why should it be so difficult to explore form - in other ways than cut, extrude, fillet and chamfer?

Also, the tangible interactions course here at AHO, was a major eye opener. Why should everything be solved with a screen? Is it the only solution, and if not, what is? Practical work with sensors and prototypes also allow for quick iterations, which I wanted to take advantage of during this diploma



# Collaboration

I reached out for Roland DG as a case partner for this diploma. Roland is a large corporation with a long heritage when it comes small-scale manufacturing machines. Their main quarters are in Japan, with offices all around the world (Roland Corporation, 2016). The cooperation with Roland during the project, will go through Jesper Bolo Petersen, 3D Product Specialist in the Danish Roland offices. Jesper has first hand knowledge of how different users interact with these machines, and during our initial talks, we discussed how they could be an asset in my process. We agreed on Roland delivering a desktop CNC-mill medio November, so that I would have time to understand the operation before the Diploma start. This mill came medio February instead, but I've had the possibility to learn the inwards and outwards of the milling process.

In return, my diploma proposal will be a source of inspiration, and they are looking into potential new areas of distribution. At the moment they do have collaborations with certain design- and engineering schools around the world, and they also offer machine training in at the same schools - The Roland School.

I've also reached out to my old primary school, and got the opportunity to drop in during wood working classes.

**Årsplan K&H, 1**

Årsplan K&H, 1 trin, 1. gang, høst/vår, 2016/2017

Uge	Hemning	Læge enkle gennemgange!	Papir Håndtering	Sindet Håkon Bil, mobil, internet, amerikansk bl. etc.
12-13	En opvækkelse	Udtrykke egne oplevelser gennem tegnning		
15	12 maj Republikdage	Udtryk og gennemgå historie i nærmiljøet og høve dette som billeder		
17-18	Bilvæs	-Eksponering med form og farve -Bilude og bilvæs egne arbejder		
18	Skolebøger	-Eksponering med form og farve		
19	Skolebøger	-Eksponering med form og farve		
20	Håndværk			
21	Håndværk			
22	Håndværk			
23	Håndværk			
24	Håndværk			
25	Håndværk			
26	Håndværk			
27	Håndværk			
28	Håndværk			
29	Håndværk			
30	Håndværk			
31	Håndværk			
32	Håndværk			
33	Håndværk			
34	Håndværk			
35	Håndværk			
36	Håndværk			
37	Håndværk			
38	Håndværk			
39	Håndværk			
40	Håndværk			
41	Håndværk			
42	Håndværk			
43	Håndværk			
44	Håndværk			
45	Håndværk			
46	Håndværk			
47	Håndværk			
48	Håndværk			
49	Håndværk			
50	Håndværk			
51	Håndværk			
52	Håndværk			
53	Håndværk			
54	Håndværk			
55	Håndværk			
56	Håndværk			
57	Håndværk			
58	Håndværk			
59	Håndværk			
60	Håndværk			
61	Håndværk			
62	Håndværk			
63	Håndværk			
64	Håndværk			
65	Håndværk			
66	Håndværk			
67	Håndværk			
68	Håndværk			
69	Håndværk			
70	Håndværk			
71	Håndværk			
72	Håndværk			
73	Håndværk			
74	Håndværk			
75	Håndværk			
76	Håndværk			
77	Håndværk			
78	Håndværk			
79	Håndværk			
80	Håndværk			
81	Håndværk			
82	Håndværk			
83	Håndværk			
84	Håndværk			
85	Håndværk			
86	Håndværk			
87	Håndværk			
88	Håndværk			
89	Håndværk			
90	Håndværk			
91	Håndværk			
92	Håndværk			
93	Håndværk			
94	Håndværk			
95	Håndværk			
96	Håndværk			
97	Håndværk			
98	Håndværk			
99	Håndværk			
100	Håndværk			

1. Side

# Analysis and research

# Introduction

In this chapter I'll run you through some of the fields and areas I explored during the research phase. The diploma started as a project where I implisittly was supposed to work with CNC-machines, since I got a colabboration with Roland. During the research phase, it showed that the problem lied somewhere else, namely in the content creation phase.

W

# The teachers role

**Every class has a teacher, and usually every teacher has an education within the field they teach. But that isn't always the case in woodworking class.**

According to a master assignment, done by Bodil Hansen (Hansen et al., 2015), there is a large variance when it comes to the teachers in wood-working class. Approximately 35% of the teachers in primary education did not have any education that was connected to woodworking or fabrication.

Each school is free to employ the teacher they want, and there is always a budget which dictates how many they can employ.

Amongst one of the most important findings is that a common way of employing a woodworking teacher is quite unusual compared to the rest of the academia world. The teacher who is the best at doing regular, home carpenting work, or in some cases making a box, gets the role of

woodworking teacher. It's as easy as that.

The pupil itself won't notice this during their education, because their skill only is comparable to their classmates at a young age. But there is a possibility that later in life and work, their skills might be lackful.

Of course, there's a number of fantastic teachers that does not have any formal education, but as technology changes the old skills might not be that essential anymore.



### The children

**I define children in primary school as my main user group throughout this diploma. There's a wide spread in age during the primary education, actually thirteen years, but I've chosen to focus on their education during the first seven years.**

Kids go to school from the year they turn 6 years old, and are taught the way of life through various course. The curriculum starts out easy, and gets more advanced as they rise in the grades.

As the subject of my diploma is digital manufacturing in wood working classes, I primarily focus on how they are taught the practical skills.

There's a large variety in the cognitive level of the children during the first seven years in school, and it's completely normal to have different skill sets and understanding various situations, according to Signe Holm Risan, Children

Psychiatrist

In addition, skills learnt at home can be a motivation for mastering.

*“Norways future lies upon the children”*

- Anita Kron Dragseth

# The milling process

**The market within desktop CNC-solutions is one in continuous development. From a start in the 80's where the prices were upwards to 100 000 kroners, to the market today where machines are being aimed towards education and home-users. The prices of these machines vary, from the simplest at around 7000,- , to the more expensive and advanced up to 50 000,-.**

Out of these solutions, I've systematically tried to categorize the different benefits of the various designs.

Operation of a desktop CNC-mill can be divided into several main categories. Before machining, during machining and after machining. Quickly described, the process goes from idea to CAD to CAM to machine. Throughout the next paragraphs, I'll try to outline the different steps

### **Before(Ideation):**

A design usually starts with an idea, which then evolves into a sketch. Already at this point, materiality becomes a factor. As of today, this idea or sketch has to be converted into a model on a computer, using CAD-software. Depending upon the budget and complexity of the model, the degree of difficulty varies a lot. The CAD-

model is necessary for the next step in the process, where you're actually creating the code in which the machine interprets into a cutting pattern.

The software used to convert these 3D-models into usable machine language, is referred to as CAM. You load up your model, specify which features you want to cut, with what end-mill, and where the origin of X, Y and Z is placed. In addition, there are several factors, such as travel speed, depth per pass, and if its a rough cut or a shape cut. As a thumb rule, the more expensive and comprehensive the software is, the more advanced it is to use. Since several of the CAM-solutions are used in industry, they also need to cater to the needs of the professionals.

### **During(Fabrication):**

As the ideation, CAD and CAM process is done, the next step is to prepare the machine with materials, and calibrate various elements.

In this element, all machines behave quite like. The material is inserted with one corner to the bottom left, and one side horizontal to the mounting board. It is then either clamped down or simply taped to mounting board.



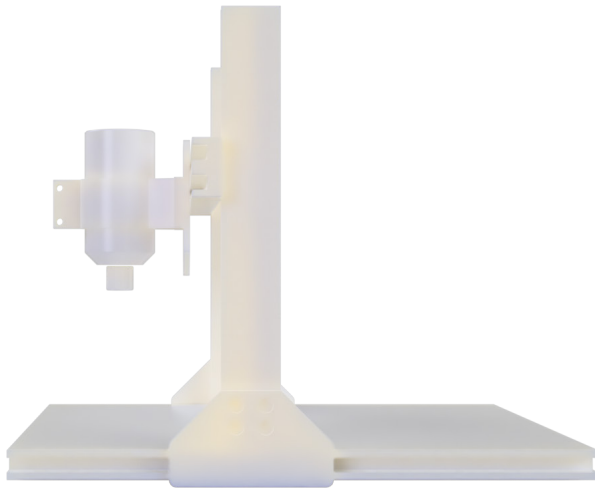

The next step is mounting of the end-mill, which in all of the desktop machines are done with a set of spanners. To calibrate the Z-axis, the most usual part is to let it drop all the way down to the ground.

**After(Finished model):**

After the print has run, and the model is cut, you either have to remove it from the tabbed stock it's connected to or it's just a matter of loosening the fastening mechanism.

**Finishing:**

Depending on the quality of the end mill, and the setup of the cam-file, you can have a smooth model, or a rough one. If it's rough, a solution would be to run another pass in the mill, or use sand paper to run it down smooth.

+ CUT DEPTH

Design  
✓ SIMILAR TO ILLUSTRATOR  
VECTOR BASED  
50+ OPTIONS  
VIEW OF SAMPLE OPTIONS TOOL PATH SEPARATE 2D/3D

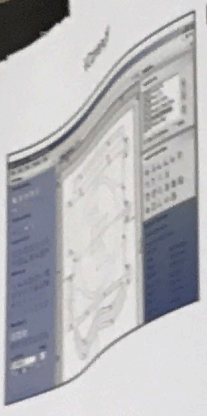

Tool path

USUAL IN 3D.  
NO EXPLANATION,  
BLUE AND RED PATHS

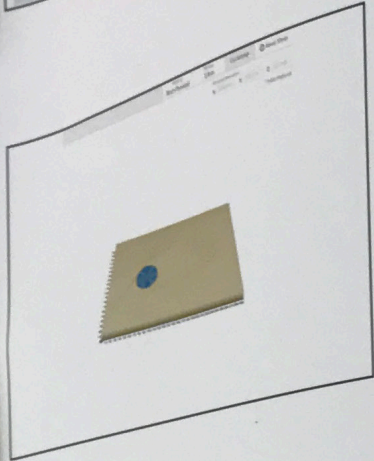

Tool path  
TOOL + SIMU IS TOGETHER  
+40 PARAM  
VISUAL MATERIAL  
3D SIMUL  
NO TOOL



Tool path  
DIFFICULT CHALLENGE  
MULTIPLE SUBCUTS  
DEPTH PATHS  
EACH PATH IS UNIQUE  
1 -> SMALL HOLE  
2 -> CUT OUTSIDE

Simulation

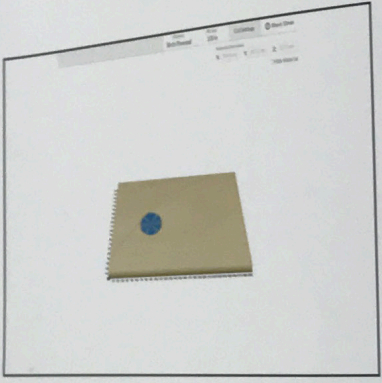

Simulation

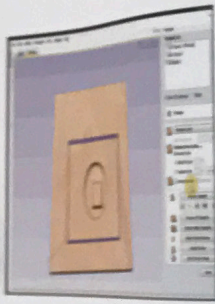

Simulation  
VISUAL MATERIAL  
LIST OF PATHS  
DESIGN VS SIMU  
ROW BUTTON D

Tool Library

VISUAL, PICTURE  
COLOR CODED,  
INFO ABOUT TURNING  
OFF BEFORE CHANGE

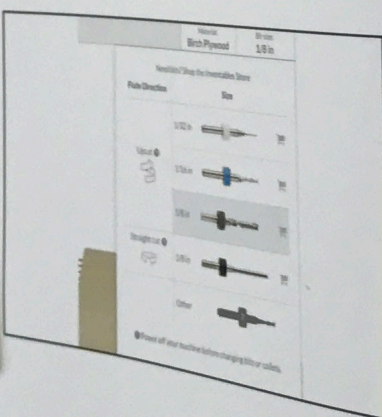

Tool Library

RENDER OF TOOL,  
SW-TYPE TOOL CHOICE,  
COMPLEX  
CUSTOMIZATION  
FEED RATES  
INCORPORATED

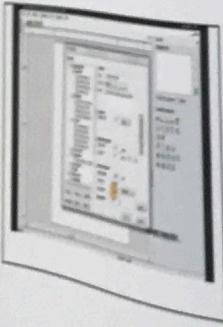

Tool Library  
EXTENSIVE, ALONG ALL TOOLS,  
SIDE PANEL PICKING WIRE  
MAN/UNLOCK  
ADD NEW.

Feed rates

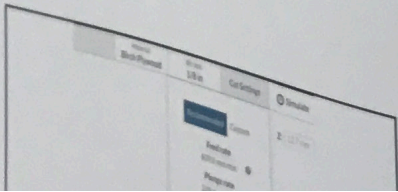

Feed rates

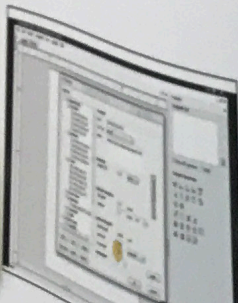

Feed rates  
AUTO FEED  
DIFFERENT WORDS  
NO VISUALS,  
NO EXPLANATION  
5 PARAMETERS

# Analysis of existing software



### Analysis of simple available software for modelling and CAM.

To perform a comparative analysis of a selection of simplest and/or included CAD/CAM solutions on the market, we had to divide the process into the steps that was needed to go from sketch to machine.

Each piece of software was evaluated on

- Design
- Tool Library
- Tool Path
- Simulation
- Feed Rates
- Calibration

The focus areas of the analysis was

- Usability
- Visual explanation
- Tool tips
- Intuitiveness
- Complexity
- Creativeness

During the analysis, a standard test was performed. It consisted of a through cut of a simple shape with curvature, with a pocketed circle inside. A 3/16" square mill was then selected as the tool for the cut, and the the toolpath was created. All of these steps were recorded as screenshots, and then the positive and negatives we're summed up.

As this diploma focuses on children/youth in primary education, the main focus for the analysis was how easy the creation of form and toolpath programming was.

The main findings during this analysis, was that the workflow was quite similar, but the explanatory quality of the graphical user interface varied a lot. There was a clear correlation between the usability and complexity of the software. The user friendly applications had less options for customizing and complex shape generation, compared to the more difficult applications, that allowed for greater freedom for modelling and machining.

Since this diploma focuses on how digital manufacturing can be integrated into primary education, this analysis serves as a method to uncover the main processes and task performed when actually producing a part.



2.5-AXIS  
Shopbot

Fastening Toolchange Security Portability Operation Calibration Software Modularity

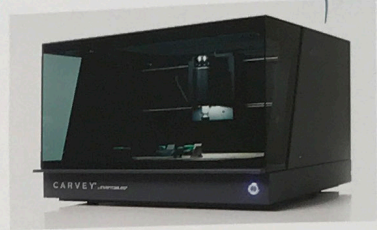
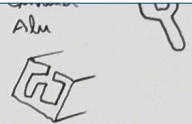

Carvey 3-AXIS

Fastening Toolchange Security

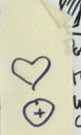

3-AXIS  
Roland SRM-20

Fastening Toolchange Security Portability Operation Calibration Software Modularity

TAPE



PROPRIETARY

ENCLOSED, GREAT  
NO 4  
WHEEL  
OPEN

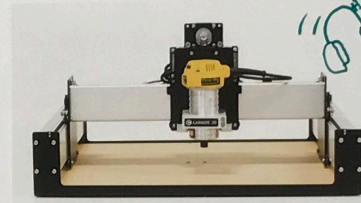
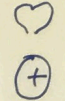

2.5D AXIS  
Shapeoko

Fastening Toolchange Security

NONE, DIY by USER.



3-AXIS  
Carbide 3d Nomad 883

Fastening Toolchange Security Portability Operation Calibration Software Modularity

SLITS, HOLES



ENCLOSED

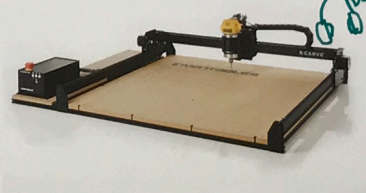

X-Carve 2.5 AXIS

Fastening Toolchange Security

HOLES  
DIY



PocketNC

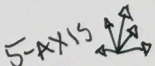

2.5-AXIS  
Shaper Origin



# Analysis of existing CNC machines

### **Analysis of the desktop CNC-market, based upon qualities.**

To perform a comparative analysis of the different actors in the field of desktop CNC-machines, I chose to include both enclosed and open machines, and also one hand-held.

Each machine was evaluated on

- Fastening
- Toolchange
- Security
- Portability
- Operation
- Calibration
- Software
- Modularity

The focus areas of the analysis was

- Ease of use
- Product semantics



Since I did not get to try all of these machines, the analysis was done with information from their respective web-sites, together with user feedback.

During the analysis, I tried to separate the pupils and the teacher, and do separate pro's and cons

for each scenario.

The main findings were that a CNC-mill consists of the exactly same parts(a spindle, three servos/steppers/sliders and a work area), and the main selling points are either work area and flexibility, or security and noise level. The tool fastening corresponds to two different industry standards, making new end-mills readily available, but making the change harder. Every machine required at least one additional tool to change the flute, in a couple of cases two.

# Årsplan K/H Sløyd & Tekstil, 7 trinn, høst/vår, 2015/2016

Uker	Tema	Kompetansemål	Læringsmål, tegn på læring	Læreverk/ Konkretisering
		<i>Mål for opplæringen er at elevene skal kunne;</i>	Jeg kan;	
	Sløyd Skål	<p>-planlegge, skissere og lage enkle bruksformer i tre.</p> <p>- arbeide med overflater i tre.</p> <p>- erfare sammenhenger mellom form og funksjon.</p> <p>-Håndverksteknikker</p>	<p>-Uthuling.</p> <ul style="list-style-type: none"> <li>* Mål</li> <li>* Bruke sag, huljern, fil og rasp.</li> <li>* Ulike typer sandpapir. (80 – 120)</li> <li>* Vinkeljern og ulike vinkelgrader.</li> </ul>	<p>s.108-114</p> <p>25 cm 4 cm inn – enden 1,5 cm inn- bredde</p> 
	Tekstil Redesign	<p>- Lage enkle bruksformer i tekstilt arbeid.</p> <p>-Gjøre rede for sammenhengen mellom ide og valg av materiale, form, farge og funksjon.</p> <p>-bruke symaskin i en formingsprosess.</p>	<p>-redesigne et nytt produkt av et gammelt produkt.</p> <p>-planlegge og skape eget designet produkt.</p> <ul style="list-style-type: none"> <li>* Arbeidstegning</li> <li>* Mål</li> <li>* Produktorientert</li> </ul>	<p>s. 66-79 s.106-107 Jeans</p> 
	Sløyd Serveringsbrett	<p>-Lage enkle bruksformer i trematerialer og kunne gjøre rede for sammenheng mellom ide, valg av materialer, håndverksteknikker, form og funksjon.</p> <p>-bruke enkelt elektrisk håndverktøy i en formingsprosess.</p>	<ul style="list-style-type: none"> <li>* Lage arbeidstegning</li> <li>* Riktig målestokk</li> <li>* Være nøyaktig med rette vinkler.</li> <li>* Tilskjæring av lister</li> <li>* Utskjæring av håndtak</li> </ul>	

Linda Sem-Strøm, Idd Skole.

# Differences in learning goals

To the left, the actual teaching goals of the 7th grade at Øberg Skole is presented. It states that the student shows signs of learning if he/she can;

- Measure accurately
- Use a file in different roughness
- Know the difference between 80 and 120 sandpaper

On a national level, it states that they should, amongst other (Læreplan i kunst og håndverk (KHV1-01), no date):

- Create simple products, and tell why the choice of materials, production technique, shape, color and function is as it is
- Use different kinds of joinery techniques between hard and soft materials
- Evaluate design and industrial production of products in everyday life, and perform user tests.

The difference between these goals are quite prominent. When I called

Undervisningsdirektoratet, a woman told me that each municipality can choose which goals they want to use in the municipal teaching goals. The school has then again the possibility to choose which of the municipalities teaching goals they want to incorporate.

The turn around for the development of a new plan for the national teaching goals are seven years. That's the time it takes from planning starts, until it's incorporated nationwide.

It's hard to imagine how the technology and techniques will change during the next seven years, and even harder to predict what will be good to learn at such an early age.

# Field Research

**During the research phase, I had contact with Øberg Skole, Biblio Tøyen, Fellesverkstedet, HP, Lær Kidsa Koding and several external children.**

The field research was quite wide, as I only started out with the concept of integrating digital manufacturing techniques in primary education. Through this period, I used informal interviews, observation and discussions as main methods.

The school has a large selection of hand tools, and the kids knew what everyone was for. There were also a medium bandsaw that the teacher only operated. When asked what their thoughts on children and alternative fabrication methods were, they stated that they were positive, but that they did not have the resources to include the teaching of the kids or themselves in the curriculum, and at least not the machines themselves.

Fellesverkstedet(an open workshope for makers),

Hewlett Packard and Lær Kidsa Koding(initiave to teach children computer coding) all have an idea that integration of technology is necessary at an early stage, to adapt to the changing society.

Biblio Tøyen, a municipal library for kids from 6 to 16 only, had taken the step to buy a couple of 3D-printers, together with computers and the necessary software. During my visit, I was allowed entrance for observation and interviews with the children. There were three kids reading books, the rest did practical things, such as building a new shelf in timber. During an interview of one of the responsible adults at the library, I asked why the 3D printers was stacked in a corner, under sheets of plastic. The answer was that Thingiverse was the problem. Neither the staff, nor the kids had the skills required to create 3D models more interesting than what already exists on Thingiverse.



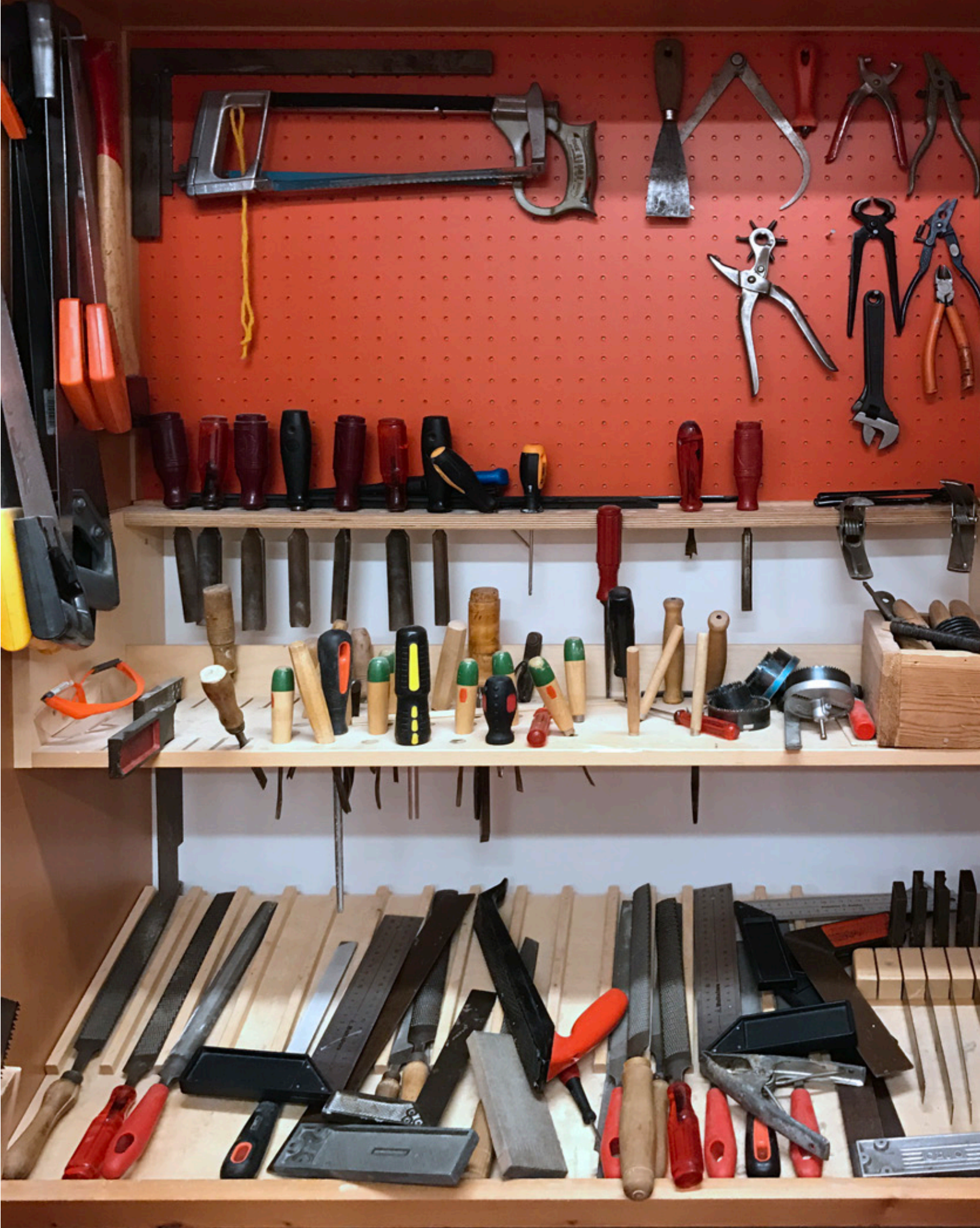

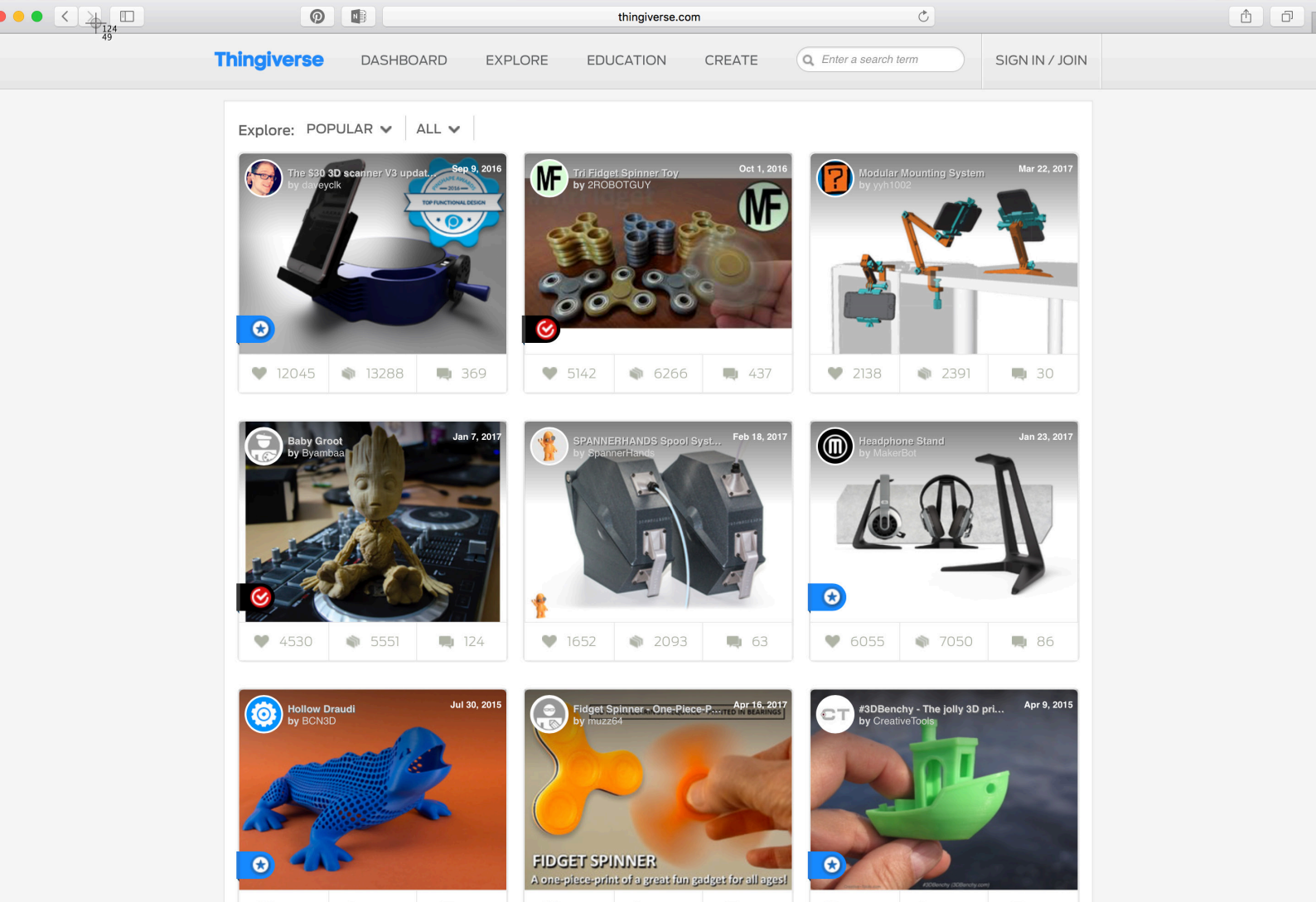

## “The problem with Thingiverse”

### **Thingiverse is a community where users can download 3D-models.**

As to what Thingiverse is, they state “MakerBot’s Thingiverse is a thriving design community for discovering, making, and sharing 3D printable things. As the world’s largest 3D printing community, we believe that everyone should be encouraged to create and remix 3D things, no matter their technical expertise or previous experience. ....” (“Makerbot Thingiverse”)

Through Thingiverse, the user can browse and download 3D models. As Tøyen Biblio stated, the problem lied at the fact that they did’nt have the skills to produce their own content. In some cases they had done some small nametags with extruded letters for each child, to great amusement for the young.

If customization was more easily achievable, the digital manufacturing methods could be more used. This would again lead to better understanding of digital manufacturing, and also futureproof the children of tomorrow.

# IDEATION

IDEA SKETCHES

VISUALS

2D REPRESENTATION

3D-SUGGESTION

IDEATION MOCK-UPS

VISUAL + PHYSICAL

3D TACTILE

SENSORIAL UNDERSTANDING

INSIGHT

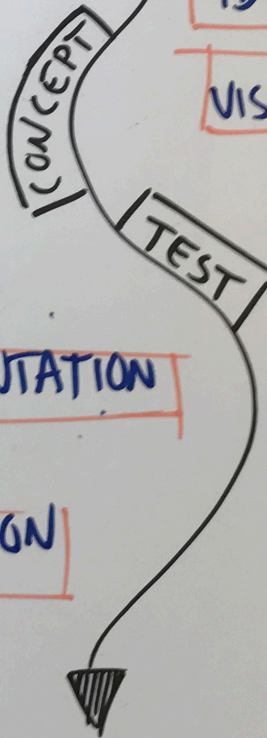

# Synthesis and Concept Development

## Introduction

When this diploma started, I was sure I was going to work with a CNC-machine. After the first mid-term, I had an idea that I would develop a solution that allowed kids to learn cross disciplinary. But, after the visit at Biblio tøyen, I moved a bit back from the narrow mind of the CNC machine it self, and instead focused on ways to create for it and a 3D printer.

The research and concept phase was not linear, it went back and forth until the three concepts I'm presenting on the next page was thoroughly explored.



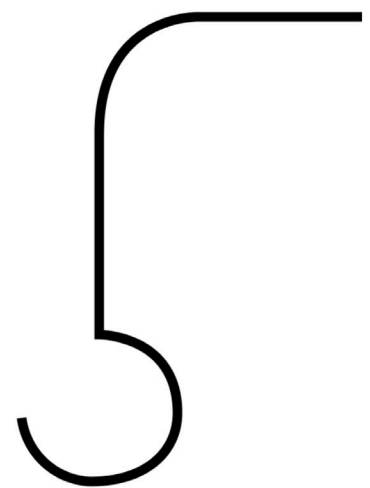
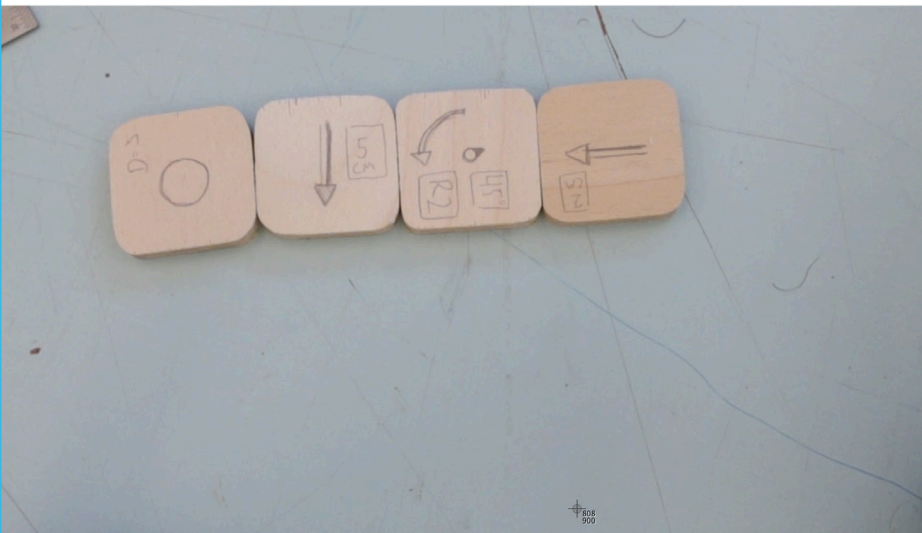
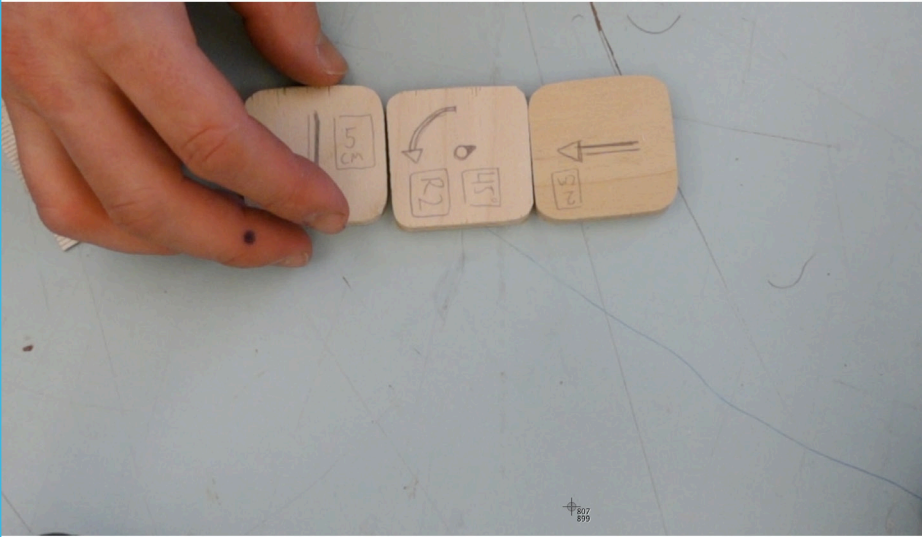



## G-Blocks concept

### Could you program a cnc-machine with physical blocks of G-code, at the same time get a better understanding of how the innards of the machine work?

G-blocks is a concept trying to aid the norwegian governments goal of inculding coding in primary education. By skipping the long lines with small text and strange symbols shown in the actual code, it replaces it with something physical.

Each block represents a specific path. This could be a partial circle/ellipse, a full circle/ellipse, or a straight line, which are basic shapes you can shape from. Given that every block had customizable parameters, such as angle, length, and radius, thos would allow for full scale routing of almost any imaginable shape.

By having a starting place, you add on blocks in a linear pattern. This creates a line of G-code which would allow for a contionous cut.

### Benefits

A solution such as this would answer to future curriculum in the Norwegian school system, and it may spur an interest for coding through practical work in the woodshop. It stimulates mathematical thinking, by having to calculate angles and lengths of each block to make a fully connected path.

### Limitations

One of the clearest limitations of this concept, which became clear during the video sketching, was that placing blocks on a linear timeline only was logical when creating straight lunes in one direction. Once you made a quarter circle, the natural choice was to connect the block on top or below the previous block, depending on which way the block was heading. In addition, the benefit from having such a solution is not beneficial when compared to existing simple CAD/CAM software. Creating the same path as shown to the left would have easier done with a mouse and a keyboard, also in primary education.

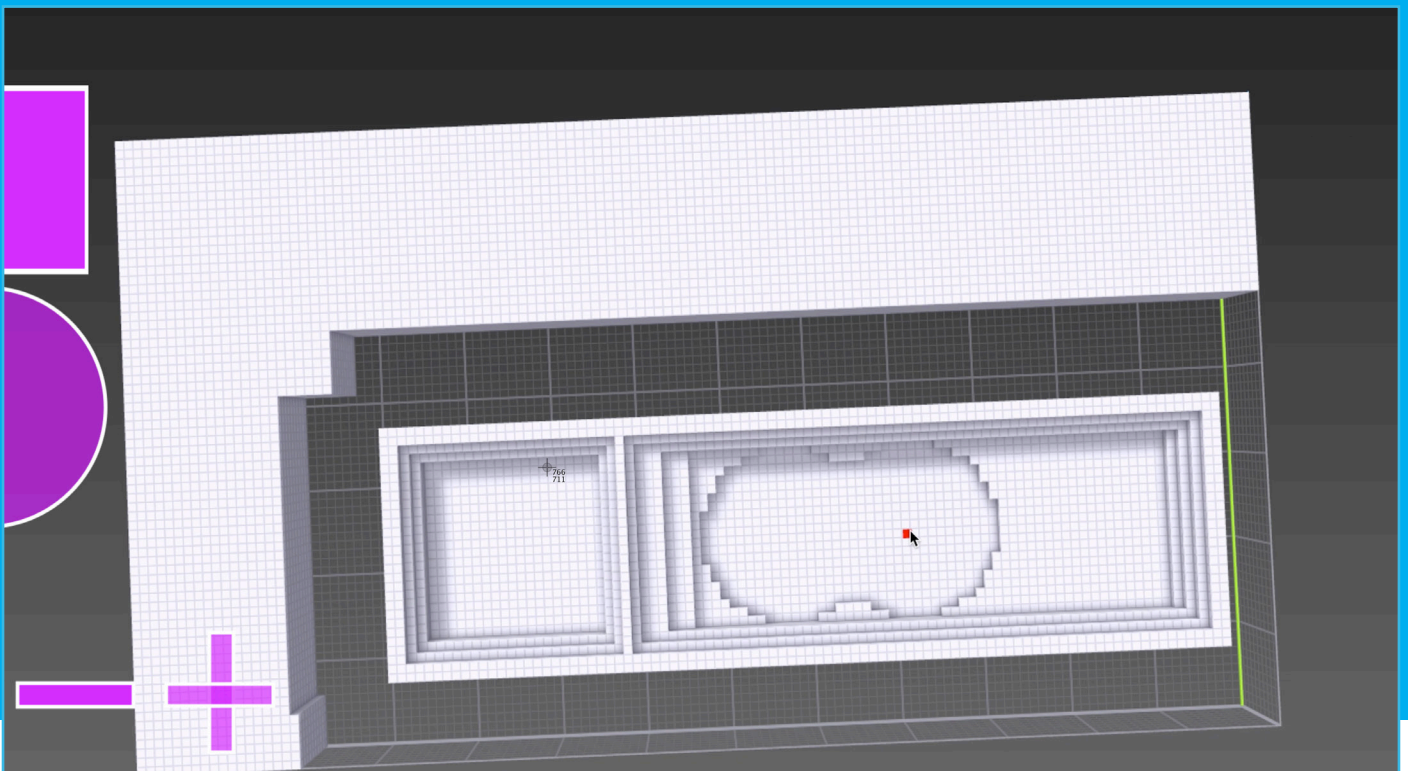
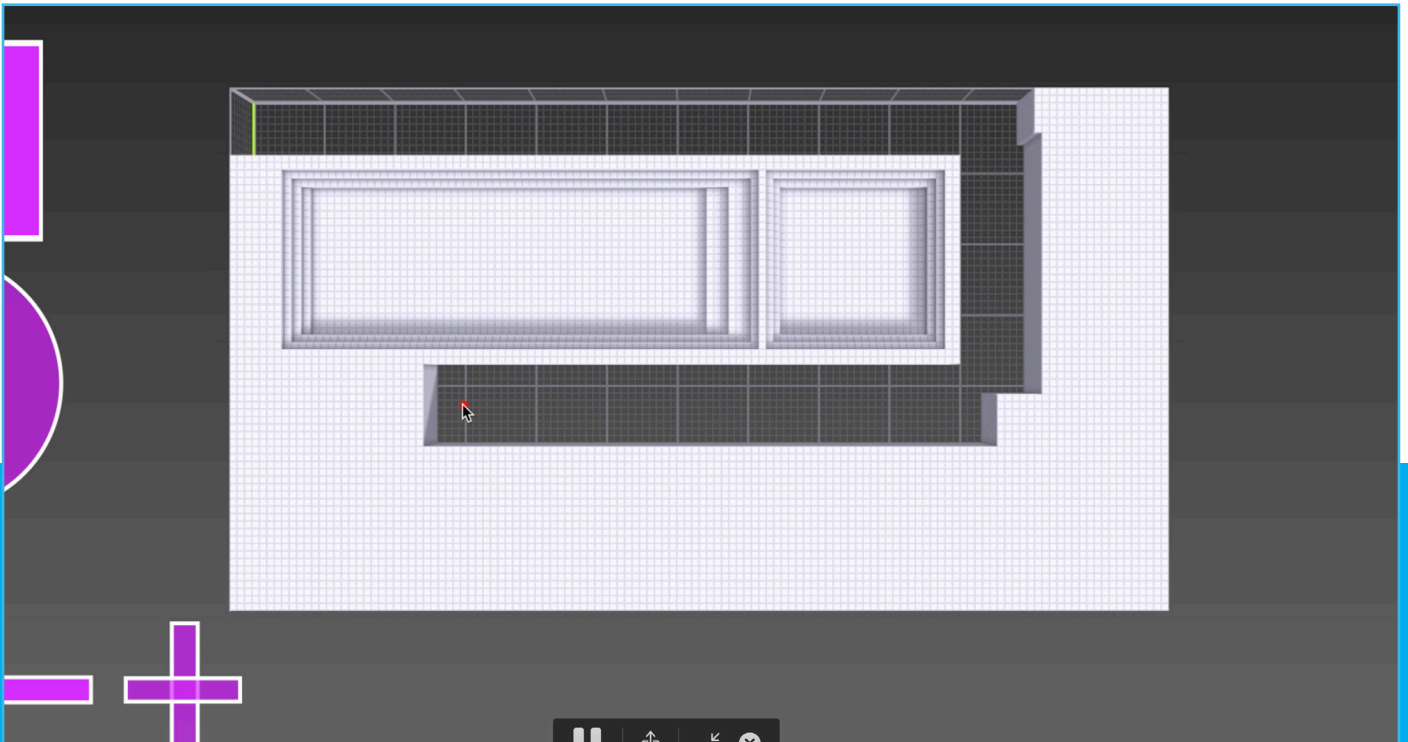

## Voxels

### What if MineCraft was actual CAD software?

During two observations with the children, I got a glance of how advanced they was in the computer game Minecraft. It 's essentially digital Lego with just with one block size. They created blocks to create shapes, and it is done while flying through, over and under the "models" they make.

With a little modification, it could be used directly for modelling basic shapes, within a certain resolution.

In this concept everything is boiled down to two main shapes, circles and squares, both adjustable in size. Each time a n area is pressed, one layer gets removed in the Z-axis.

### Benefits

Video games are a sure way to create interest, especially if it was directly transferable to a 3D model. If this kind of software was gamified, theres also possibilites of creating more difficult modeling scenarios, where you gain real practical skill and understanding for digital manufacturing in the school as the user "levels up"

### Limitations

Challenges arise when using the same game mechanics as Minecraft. By being able to remove any block they want, they have the opportunity to create impossible structures, thats not possible to recreate in real life. There 's also an argument about the use of more screens in todays everydaylife.

If we consider the learning outcome of this concept, compared to the other selections, it might not be directly connected to the workflow in present CAD software

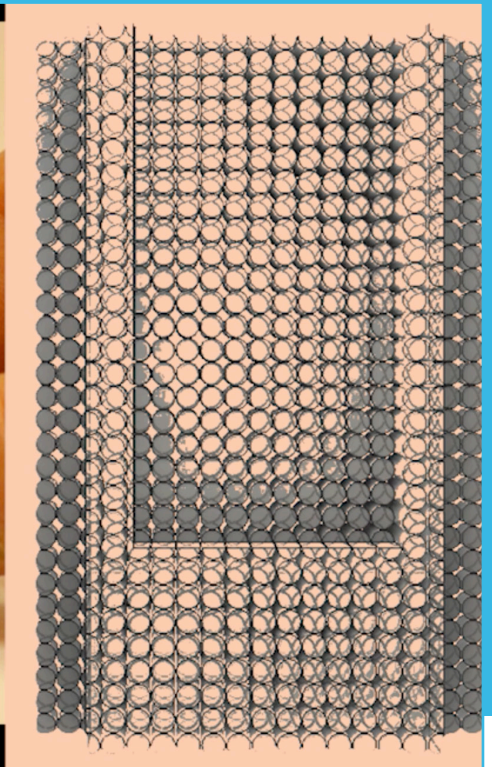
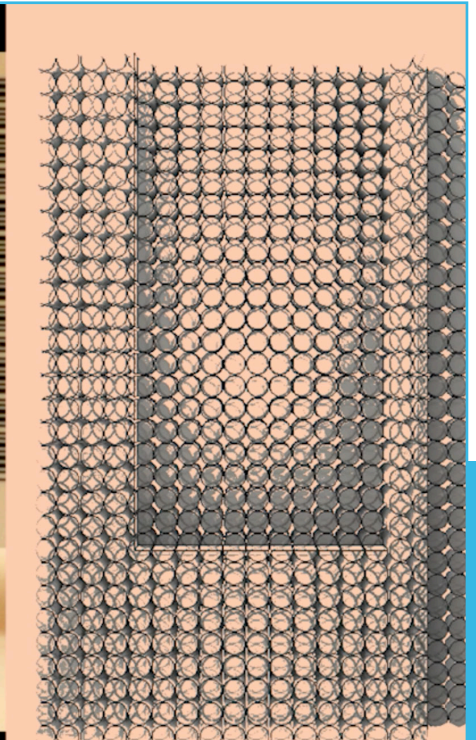
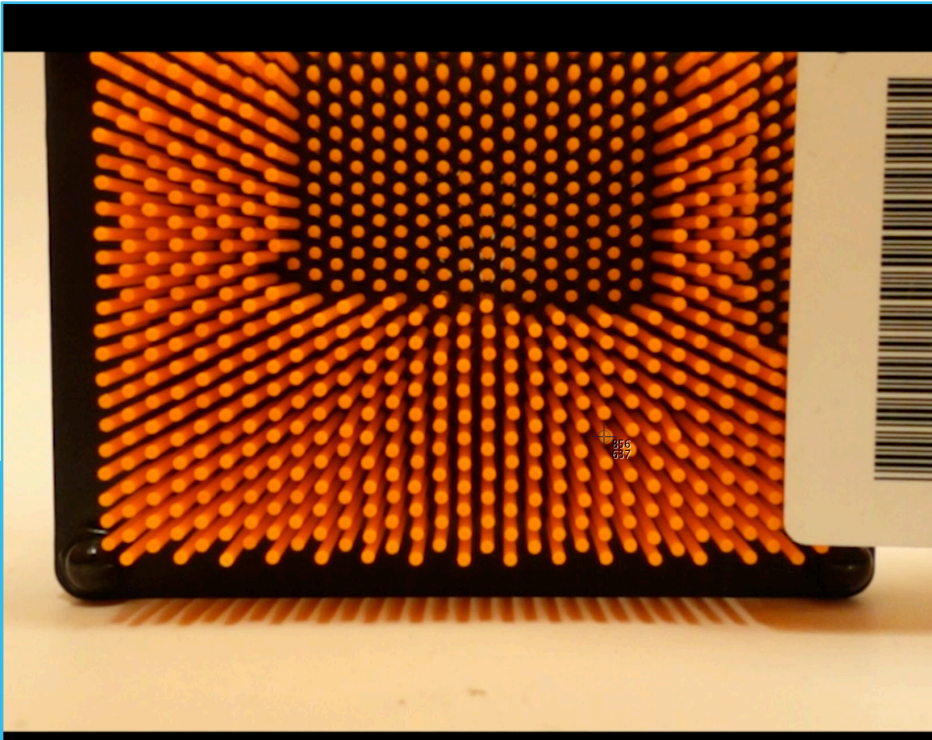

## Needle pin

### Could an old childrens toy

Needle pin is a concept based on the old needle pad toy. It relies on gravity to fall onto an object, and then recreate a relief of the shape beneath.

In this concept there's a digital connection between the pins and the modelling. The high resolution of pins is well suited for manup

### Benefits

This potential has a direct connection with the actual model. What you see is what you get. This allows for a tangible relation to whatever shape you create or use as a base for modelling. In addition, its main purpose as a toy is to represent shapes.

### Limitations

Resolution and gravity are the two main limitations of this technology. To make it feasible, it has to be



# Development of Final concept

## Introduction

**The chosen concept ended up being the one with the most potential for shape, namely the needle pin concept**

for resolution.

After visually prototyping the previous concepts with video sketching, paper prototyping and processing, I went on to select the one that I felt had the most potential as a creation platform. As the users didn't have a great understanding of what my diploma actually was focusing on, namely digital manufacturing itself, my hypothesis is that by having a pre-made toy that actually existed as a base worked to create a base of semi-mutual understanding when it came to discussions.

The development phase was the main part of my work and exploration during this process. Several rounds of direct user testing, trying to figure out how to explain the concept in the best possible way.

The main interaction of the model is to change the height of the 500 different pins that are available





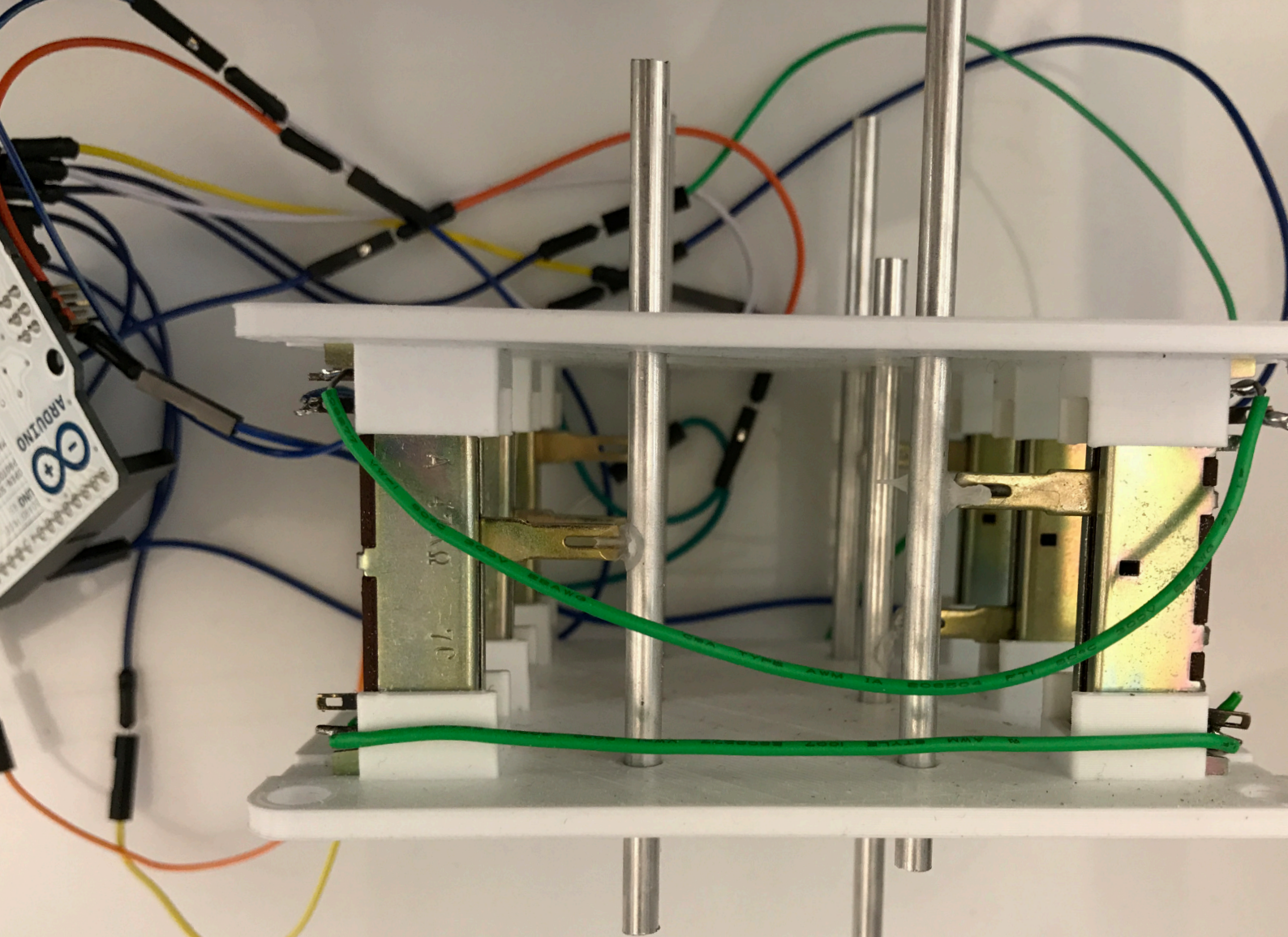

Development of final concept

---

## Functional prototype

**Explaining a non-existing product to children, which also is ment to communicate with machines they don't know exist proved difficult.**

To aid in user testing, I created a 2\*3 matrix that has the same Z-axis travel as the main concept would have. By utilising Arduino and Processing, I was able to create a solution that produced a mesh file that could be exported as a 3D-file that either could be milled or printed.

To illustrate the manipulation in a understandable manner, a rotatable view of the model was presented on a screen, displaying change in Z in realtime.

By having a direct connection between a physical and virtual model, the concept was a lot easier to explain. The prototype was used to mill and print out actual forms that the user created, albeit with

a 2\*3 resolution.

The model consists of 6 potentiometers with 35mm travel, and each Z-position is read 100 times a second. The ratio compared to the output file is 1:1. This also dictates that the distance between the pins on functional prototype is equal to the distance between the mapped points in the 3D-file you get as an output.



```
import processing.opengl.*;
import igeo.*;
```

```
import processing.serial.*;
import cc.arduino.*;
Arduino arduino;
```

```
//saves the values of all the pins.
float pin1;
float pin2;
float pin3;
float pin4;
float pin5;
float pin6;
```

```
void setup() {
  size(1280, 1024, IG.GL);
```

```
  IG.bg(13, 57, 76) ;
  arduino = new Arduino(this, Arduino.list()[1], 57600);
```

```
  for (int i = 0; i <= 13; i++)
    arduino.pinMode(i, Arduino.INPUT);
}
```

```
void draw() {
```

```
  refpiGeon();
  pin1=map(arduino.analogRead(0), 0, 1024, 0, 40);
  pin2=map(arduino.analogRead(1), 0, 1024, 0, 40);
  pin3=map(arduino.analogRead(2), 0, 1024, 0, 40);
  pin4=map(arduino.analogRead(3), 0, 1024, 0, 40);
  pin5=map(arduino.analogRead(4), 0, 1024, 0, 40);
  pin6=map(arduino.analogRead(5), 0, 1024, 0, 40);
```

```
  IVec pt1 = new IVec(0, 0, pin1);
  IVec pt2 = new IVec(40, 0, pin2);
  IVec pt3 = new IVec(40, 40, pin3);
  IVec pt4 = new IVec(0, 40, pin4);
  IVec pt9 = new IVec(40, 80, pin5);
  IVec pt11 = new IVec(0, 80, pin6);
  IVec pt5 = new IVec(0, 0, 0);
  IVec pt6 = new IVec(40, 0, 0);
  IVec pt7 = new IVec(40, 40, 0);
  IVec pt8 = new IVec(0, 40, 0);
```

```
  ISurface surface1 = new ISurface(pt1.dup(), pt2.dup(), pt3.dup(), pt4.dup()).clr(1, .8, 0);
  ISurface surface2 = new ISurface(pt6.dup(), pt5.dup(), pt1.dup(), pt2.dup()).clr(0, 1., 1.);
  ISurface surface3 = new ISurface(pt7.dup(), pt6.dup(), pt2.dup(), pt3.dup()).clr(0, 1., 1.);
  ISurface surface4 = new ISurface(pt8.dup(), pt7.dup(), pt3.dup(), pt4.dup()).clr(0, 1., 1.);
  ISurface surface5 = new ISurface(pt8.dup(), pt5.dup(), pt1.dup(), pt4.dup()).clr(0, 1., 1.);
  ISurface surface6 = new ISurface(pt5.dup(), pt6.dup(), pt7.dup(), pt8.dup()).clr(0, 1., 1.);
  ISurface surface7 = new ISurface(pt4.dup(), pt3.dup(), pt9.dup(), pt11.dup()).clr(0, 1., 1.);
```

```
  if (keyPressed) {
    if (key == 'p' || key == 'P') {
      IG.save("pinmodel.3dm");
    }
  }
}
```

```
void refpiGeon() {
```

```
  IPoint[] ptarr = IG.points();
  ICurve[] crvarr = IG.curves();
  ISurface[] srfarr = IG.surfaces();
  IBrep[] breparr = IG.breps();
  IMesh[] mesharr = IG.meshes();
```

```
  for (IPoint pt : ptarr) {
    pt.del();
  }
  for (ICurve crv : crvarr) {
    crv.del();
  }
  for (ISurface srf : srfarr) {
    srf.del();
  }
  for (IBrep brep : breparr) {
    brep.del();
  }
  for (IMesh mesh : mesharr) {
    mesh.del();
  }
}
```



Form discussions on a later form concept. The shape, handling and grip all got plenty of honest critique, creating the need for a last iteration that fixed the grips.

## Development of final concept

---

### User testing

**User testing is the pinnacle of product design task, especially in user centered world. My main problem was that user testing a concept which doesn't exist in the real world, essentially a thought, is hard to explain.**

After the main concept of interaction was chosen, there was performed three rounds of user testing with kids in the age between 9 and 13 year.

#### Round 1

The first round focused on how the interaction with existing toys, namely the "needle pin" went. The interaction with this toy was absolutely natural. Given that it's driven by gravity, it allows for quick shape exploration, dictated by the angle you use it.

The task I gave during the first round, was to connect to objects, through the use of the "pin cushion". The main findings of this user test was that the kids did not account for gravity, when displaying their work. The pride they had when they created a beautiful model, and the unhappiness and surprise they experienced when everything was zeroed when they tried to show me the model, due to gravity

#### Round 2

Before performing round two of the test, I created a model with a compromised resolution, 12\*12 pins, with work area of 12cm\*10cm\*2cm. Together with this, I brought the high resolution pre-made toy. I gave them three different tools to manipulate with. The resolution of my concept model was too low to create anything remotely circular, and the pressure needed to manipulate the pins were too high for freeform modelling.

To communicate that the adjustments they made on the model would be represented as a 3D-model, I created a scanning solution in Kinect, which created a point cloud that was shown in real time in 3D. This point cloud, and the fact that it also scanned the body, proved ineffective. Their interest moved from the product, which didn't have any other interaction than moving the pins themselves, to a camera which displayed them in a previously unseen manner on screen.

#### Round 3

This round was conducted with two different models. One non-functional, but high resolution model, compromised of 25\*20 pins, with a work area of 120\*100mm together with the working 2\*6 pins matrix demonstrated on the previous page. This actually allowed for proper discussions around the larger, non functional model. By

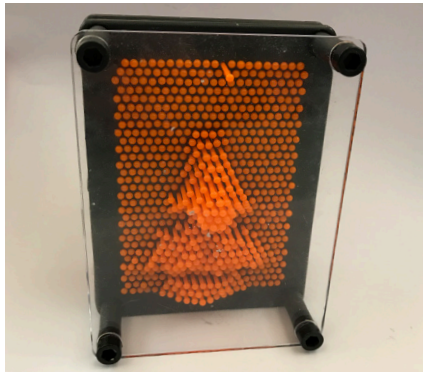

Pre-made pin cushion, used in round 1

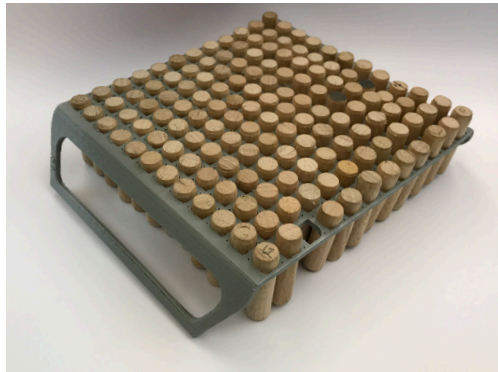

12\*12 pin model used in round 2

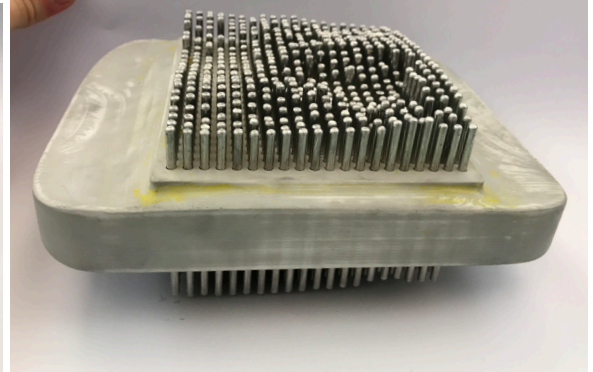

25\*20 pin model used in round 3

being able to view the 3D-model onscreen as it was modified with a 1:1 ratio, they started manipulating and playing with the larger model, as intended.

In addition, I presented three different product design, and discussions about ergonomics and form went in another direction than I had thought on beforehand. As they compared the different ways of grabbing the model, both when used as a free form tool and as a “scanner”, the at the time finalized product design was disregarded by the users, in favor of an older product design idea. This created a need for an extra iteration before delivery.

#### Round 4

The last user feedback was conducted a day before the final delivery. Together with the model, they were presented two pieces of printed PLA, 1:1 with the same resolution as the final model will output. This round was conducted with a different set of users, not being presented the prior form concepts, or interaction concepts. Once they saw the PLA model and had “made” a reproduction by creating an imprint from the back, they understood the mechanics of the concept.

The grip surfaces we’re utilized as intended, and the handling was super but the low pressure needed to manipulate the pins made them to careful when it came to rougher handling, so they did not dare to exploit it to the fullest. As far as the modes of the product, I explained it with two different models. These were created with a scallop mode and with a regular roughcut.

#### Summary

User testing a product that does not work, is a challenging process. Explaining the basic working, also needs to be backed by simultaneous modelling the model as they manipulate and explore. In addition, when the manipulation of the pins movement aren’t completely smooth and they don’t move with the pressure intended, the experience of the use is not intuitive.

The users hand, also needs to grip outside of the matrix, because accidental modification of their intended shape happens quite often when using the product with short grips..

Zeroing, or resetting the work surface must be explained or intuitive, and the need for legs is dependent upon this.

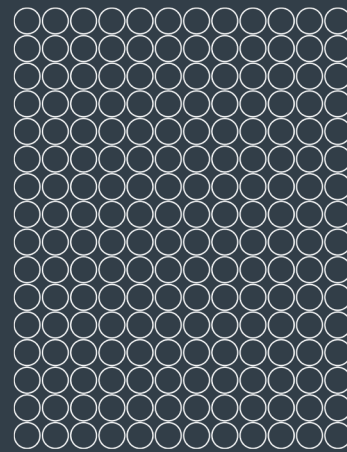
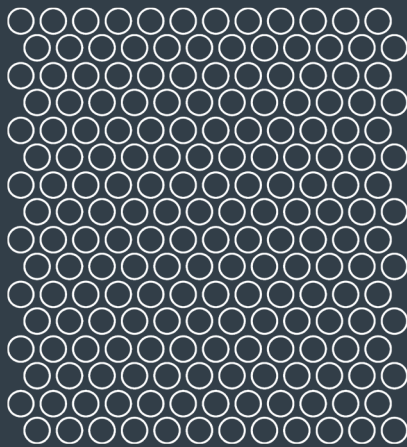

## Development of final concept

### Organizing of the pins and resolution

**Placement of pins, together with the resolution, dictates how detailed the models produced will be, but it also dictates how curves can be reproduced and which size end-mill must be used.**

**Organizing:**

There are primarily two viable options when it comes to creating a matrix. One option is completely linear (right side, above) and the other option is with an offset of half the width of one pin (left side, above). Option 1 allows for tighter pin placement, and option 2 leaves room in between every four pins. With regards to a realizable construction, and room for circuits that reads the pin position, option 2 was chosen. A strict linear pattern.

**Resolution:**

The resolution of the concept is crucial for the possibilities of the product. A combination of low resolution, eg. 12x12, together with a linear matrix, works good with reproducing straight lines, and sharp angles in the XY-plane. When it comes to curvature, organic shapes and circles, the lower resolution essentially turn every thing

into squares. As an example, if you want to reproduce a 60mm diameter circle on 12\*12 pin matrix in the size of 150\*150mm, you would basically end up with the shape of an odd square, as illustrated on the right. By upping the resolution of the matrix, and downsizing the work area, the circle imprint will become more and more circular. The final chosen matrix/area resolution was 25\*20 pins in an area of 120\*100mm. When you try to recreate the same circular shape, you actually end up with something that resembles a jagged circle, as illustrated on the right.

Converted to a digital format, and then roughcut with a 6mm end flute in a cnc-mill, would end up like figure x5. As demonstrated, there is a notable difference between the result of the low and high resolution pattern.

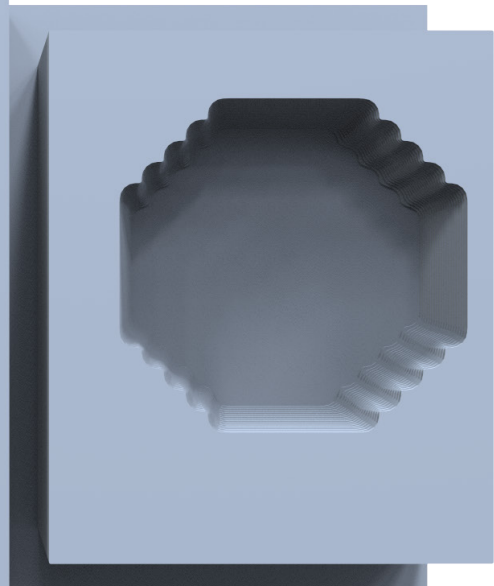
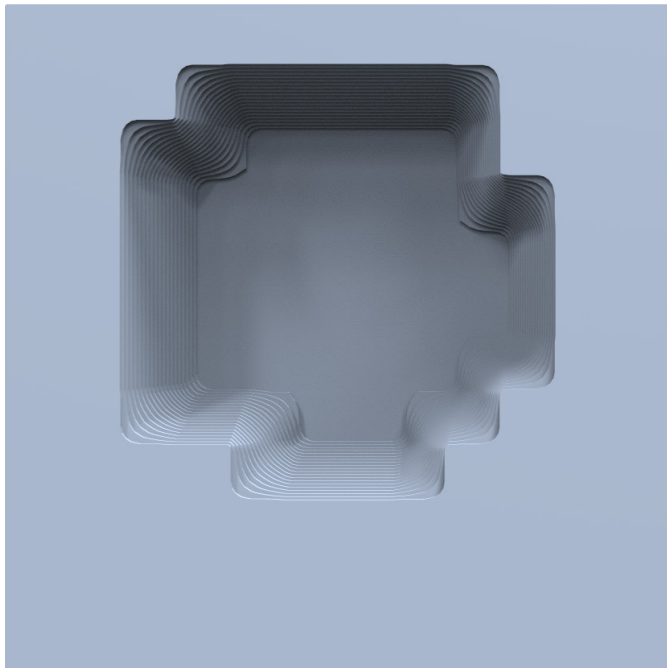
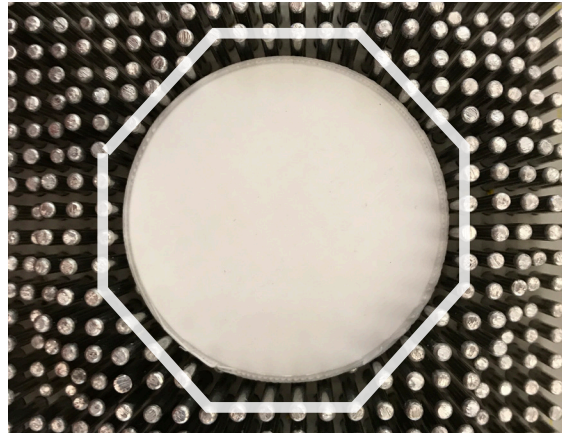
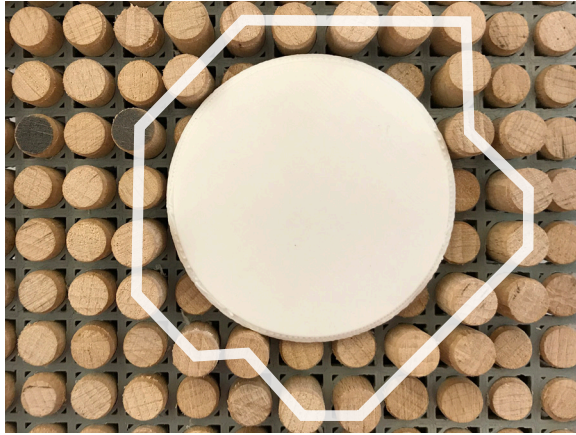

Development of final concept

## Moodboard and Inspiration







# Development of final concept

## Shape exploration

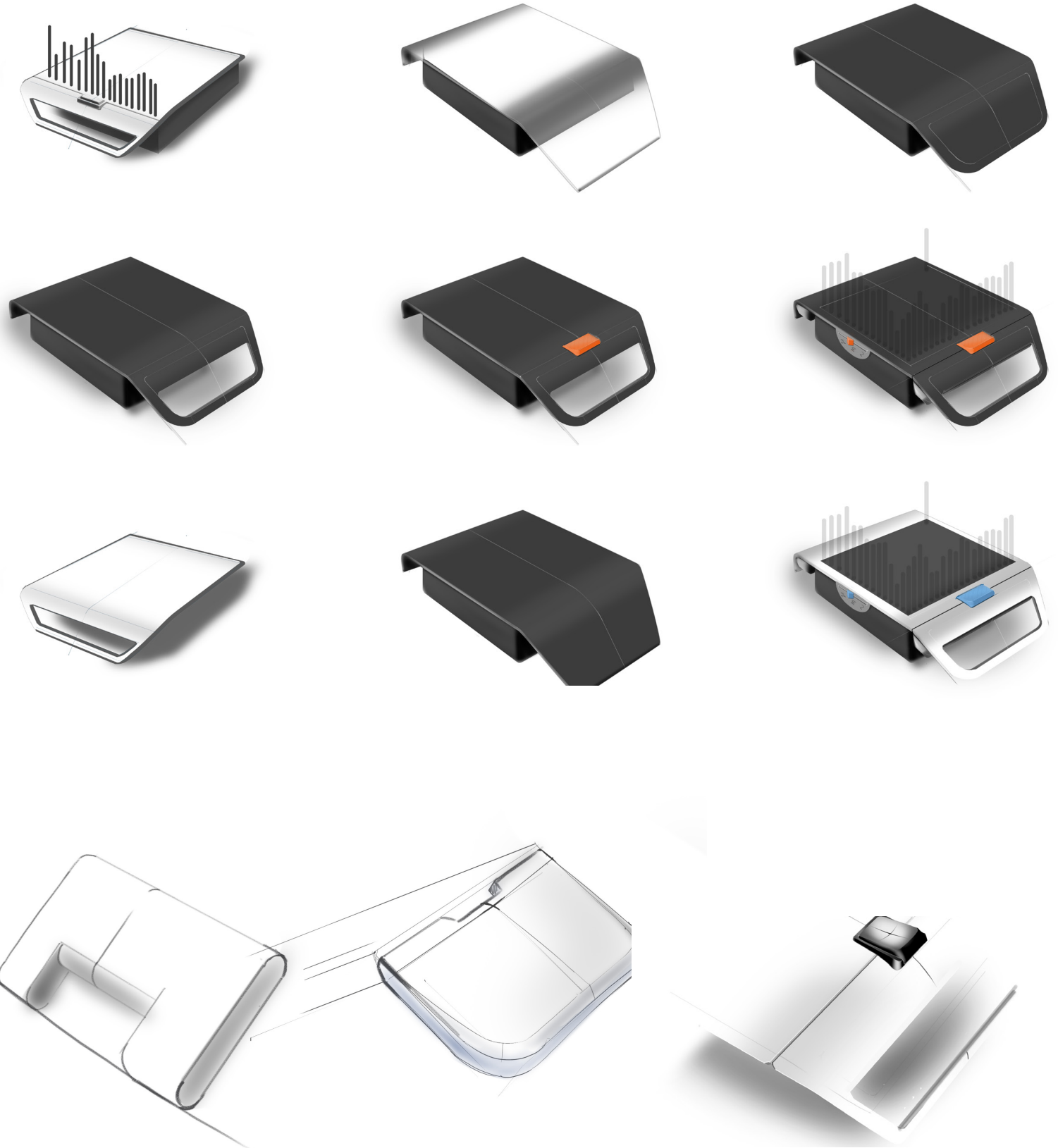

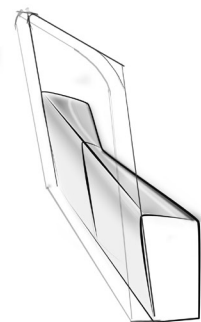
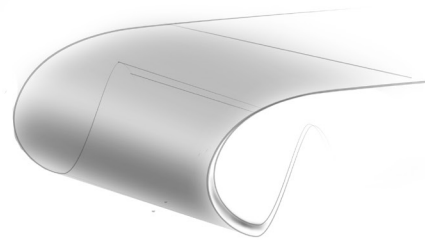
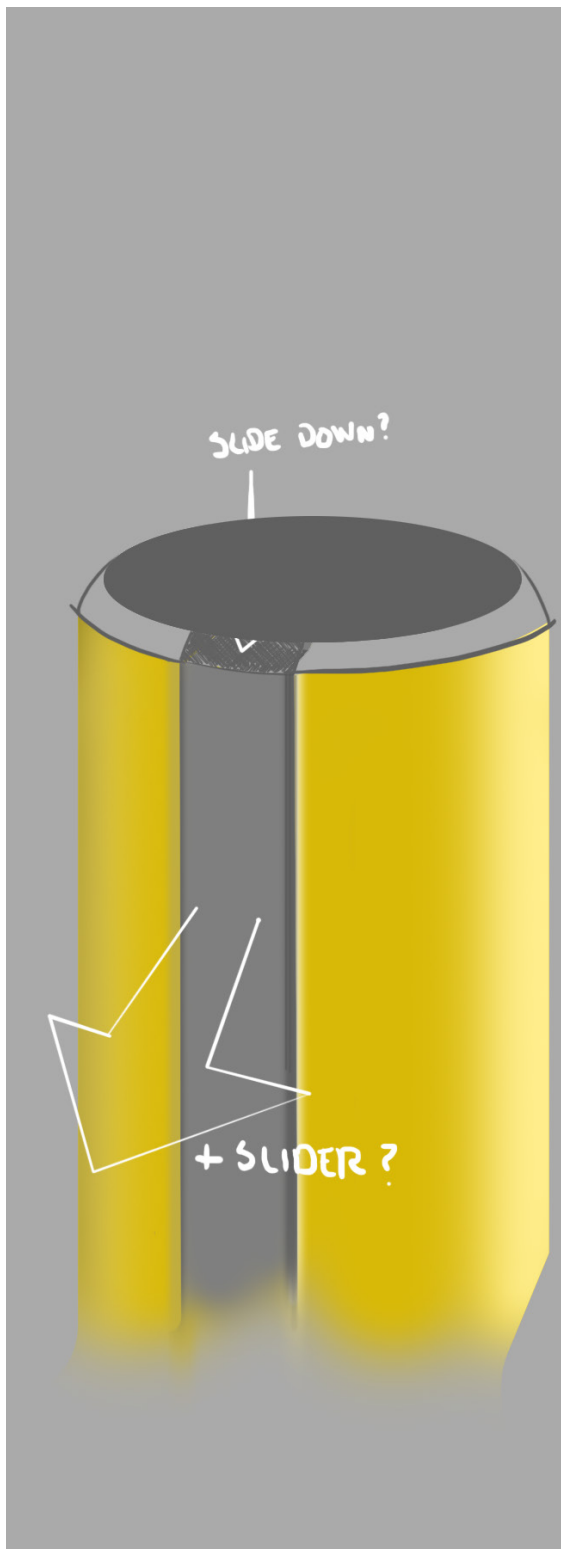
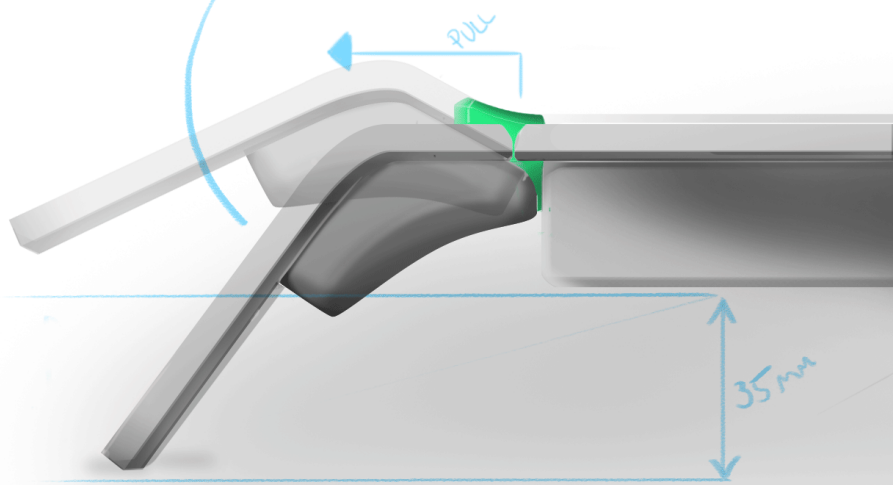

# Development of final concept

## Modeling

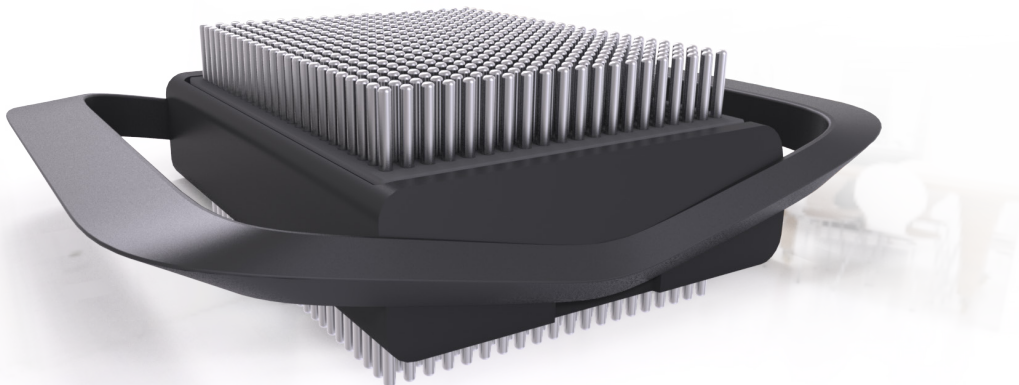
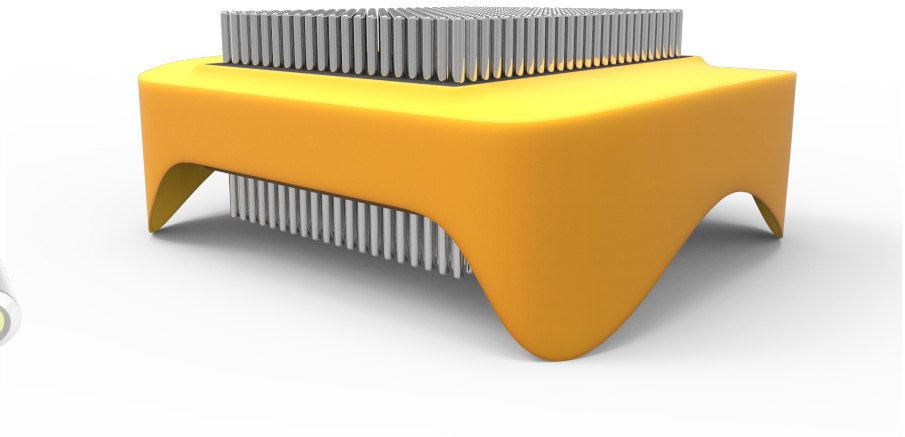
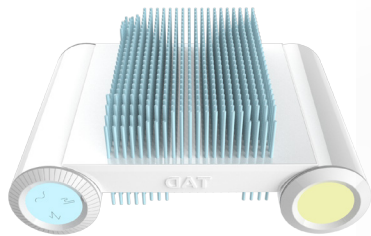
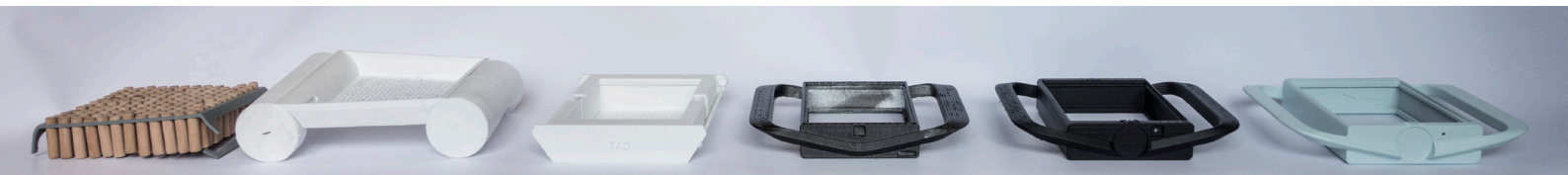

1st

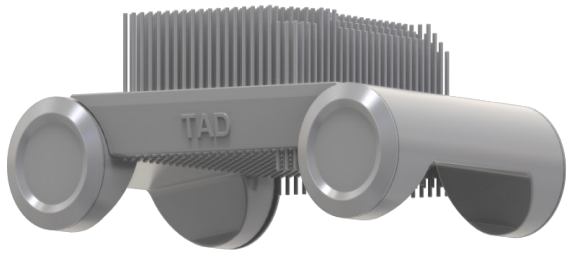

6th

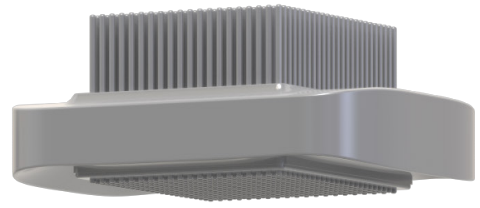

2nd

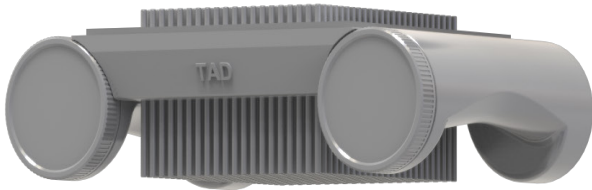

7th

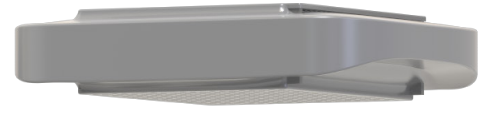

3rd

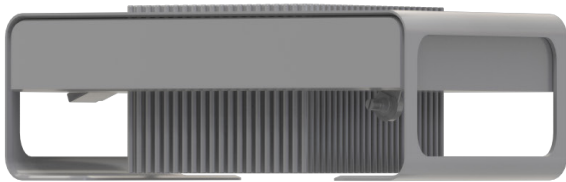

8th



4th



9th

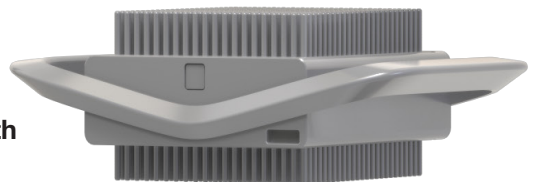

5th

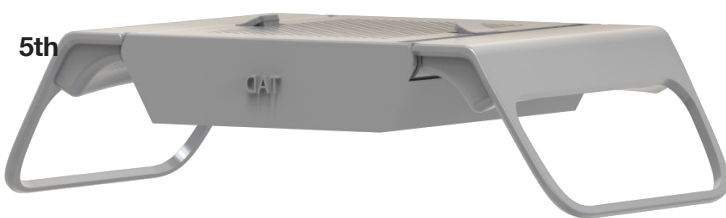

10th

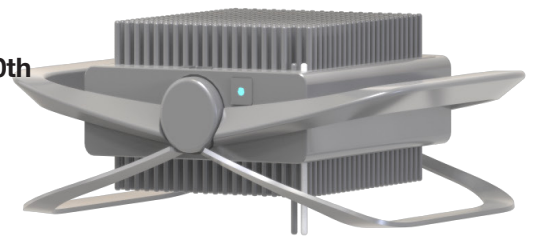

# TAD - Tangible Aided Design

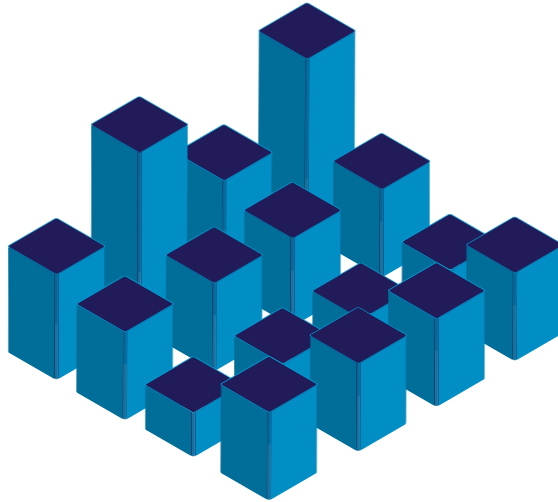

TAD  
Tangible Aided Design





**TAD - Tangible Aided Design - is a tool to enable rapid 3d-modelling. Removing the computer and comprehensive software from the equation, manipulating 3D-form directly in a 1:1 ratio between the finished workpiece, it lets the pupil unfold their creativity in a new manner.**



**A physical tool**

that makes digital modeling intuitive





**Enjoy the feeling of creating**



**something from scratch.**



Everything around you becomes



a tool for creation and exploration



Explore different



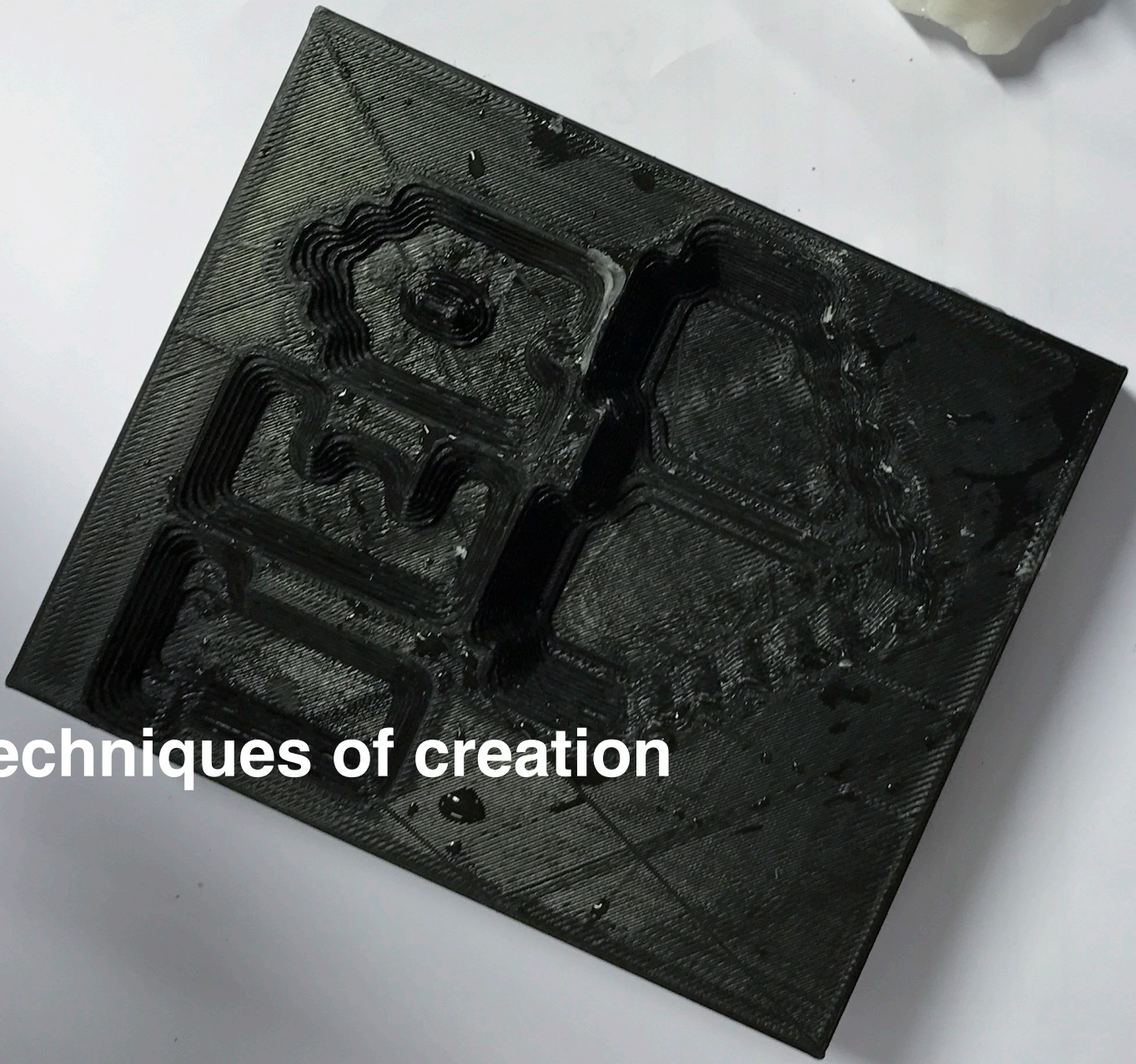

**techniques of creation**

### Resolution

The number of controllable pins defines the resolution of the final model. Tad has a resolution of 25 by 20 pins, adding up to 500. This allows for more complex works. The 2 mm spacing allows for a larger work area. Each pin moves from max height of 36mm to min of 1.



### Changing modes

A rotating dial, indicated by a protruding shape compared to the rest of the main body, switches between the different modes of modelling. The different attributes of each mode are explained on the right.

### Tangent path

As the Z-value changes, a tangent path is drawn between each point. This enables the creation of smooth surfaces on the final mesh, without sharp edges.



### Leveled path

In this mode, each pin has a larger volume, creating 90° edge between the different z-values. This creates a final mesh in kote-form.



### Closest path.

Each pin represents a fixed point in the X- and Y-plane. As the Z-value varies among the individual pins, a direct path is drawn between the points, hereby creating a polygon mesh.



## Communication

TAD communicates via wireless connection. There is also an available micro-USB on the backside, for charging and updating.



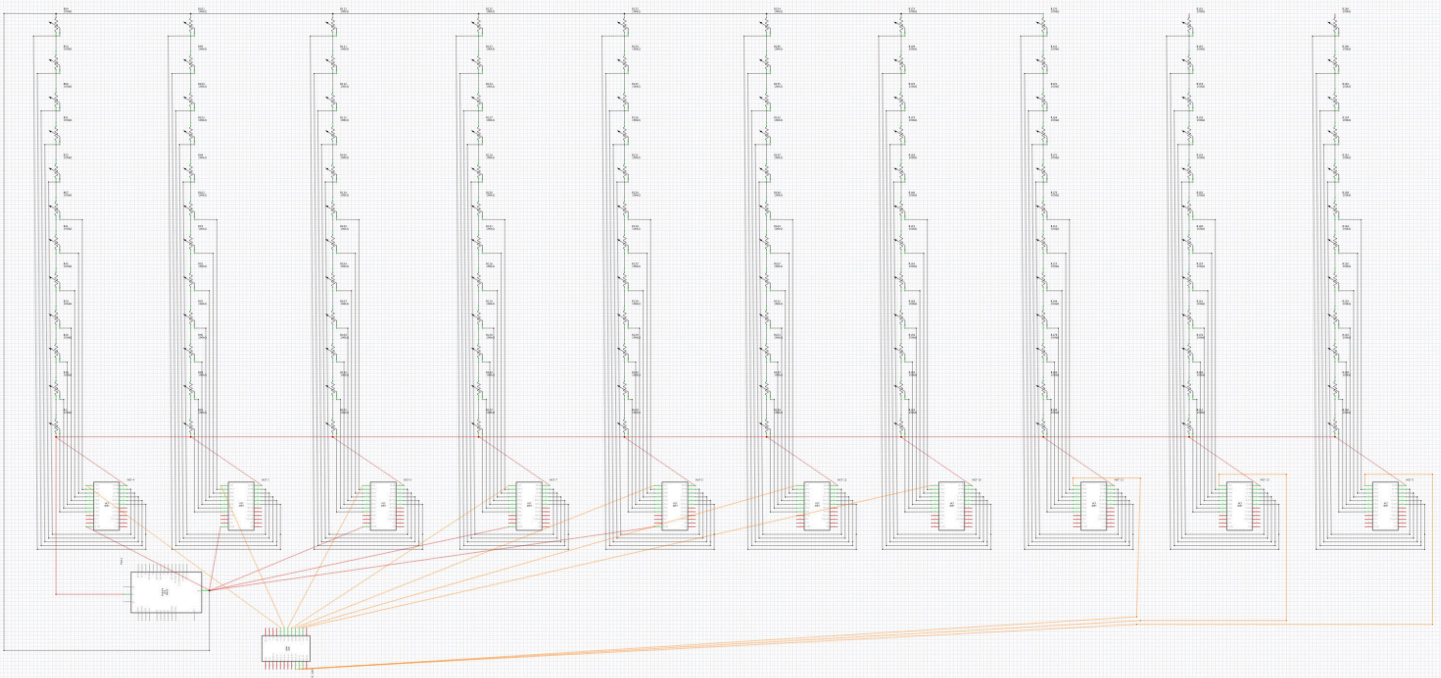

### Sensing technology

TAD works with a large matrix of simple “potentiometers, all individually connected to a logic board that can sense 1023 different positions in the Z-axis. With it’s 35mm of travel, this allows for a precision of 0,05mm. By utilising multiplexers, every pins position can be read at rapid pace in realtime, even with a resolution of 500 pins.

Below there is a representation of how the pin would be constructed. The copper colored contacts are connected across each row on the top plate, and the same for each column on the bottom plate. The grey material on the pin itself is conductive material with very low resistance. The darker material on the pin consists of a

material with high carbon content, and consistent resistance the whole length. By measuring the resistance from top to bottom, you get which height the pin is. To know which pin, you sequentially turn on power between column x and row y, until every combination of columns and rows has been read. With low processing power, this would have an update rate of below 1/10th of a second.

Just to clarify, the wavy shape at the top and the bottom is stationary, while the pins slides alongside them, making contact and outputting varying resistance as they are moved.

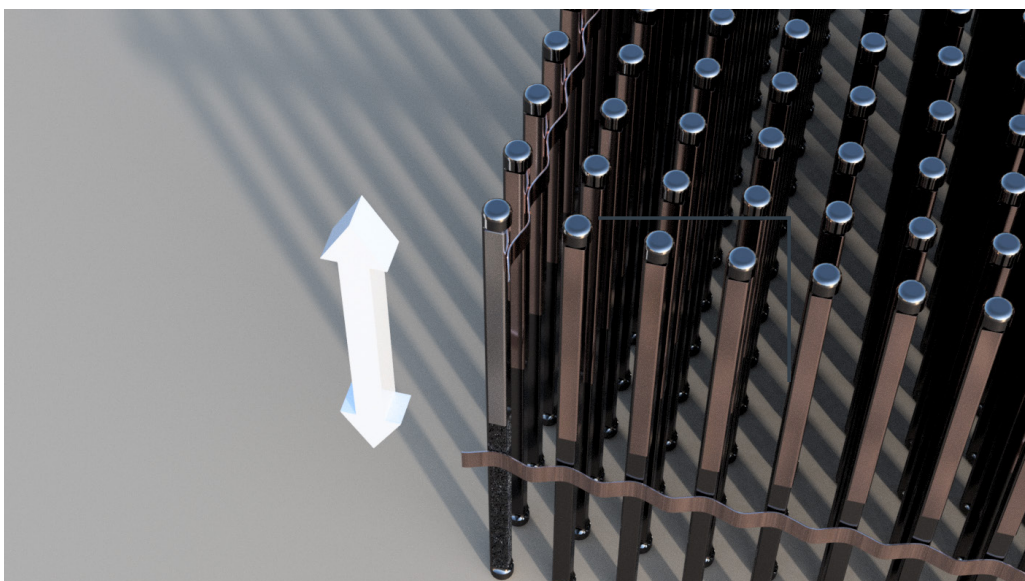

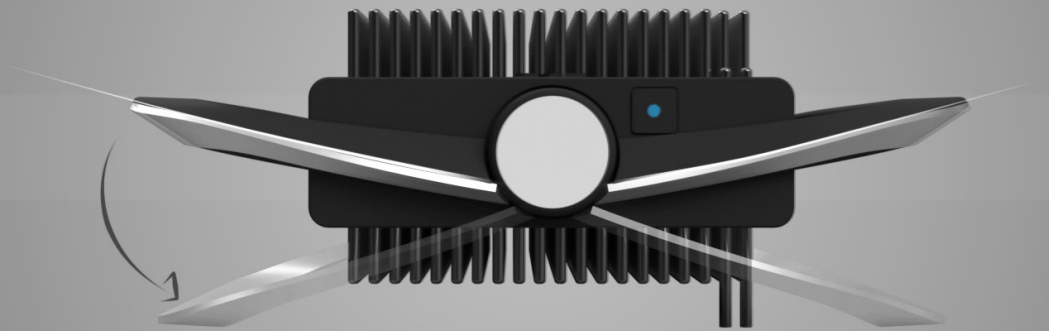
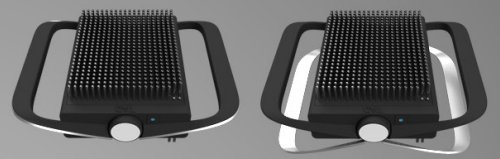

## Shape

The handles have a shape that invites lifting, and are at a fingerlengths distance from the pins, ensuring that a potential beautiful model does not get manipulated by accident.

The black color is a functional choice. By having everything black, it leaves the maximum of contrast towards the pins, allowing the shape of the pins to be as visible as possible.

To stimulate the user to think about form when he/she uses TAD, it has a lot of double curvature surfaces, and a mix of sharp and mellow edges.

All the gripping surfaces has been modelled such that it grips well without being sharp in the palm.

To cope with zeroing or resetting the model area, it has legs that folds up when the user wants to

press it down towards a flat surface. This is also practical when it's used to explore shapes in the environment around you. The shape of the legs is the same as the handles, except with an offset of 2mm.

The button extrudes the symmetric shape, and creates an up direction when held vertically.

All of these traits, aids as help to get the concept understood, initially. Even though appreciation of shape is individual, the main body has some great qualities when exposed to passive lightning.

This is further emphasized by the black piano finish that has been sanded down to a matte gloss.

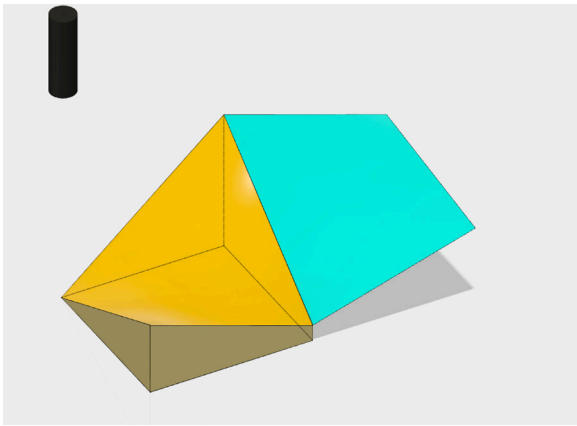

### Conversion from tangent mode to g-code

This is a representation of how the shape changes, if outputted with a rough cut with a 4mm square flute. The yellow lines are the path the end-mill follows, and at the bottom the finished result is simulated.

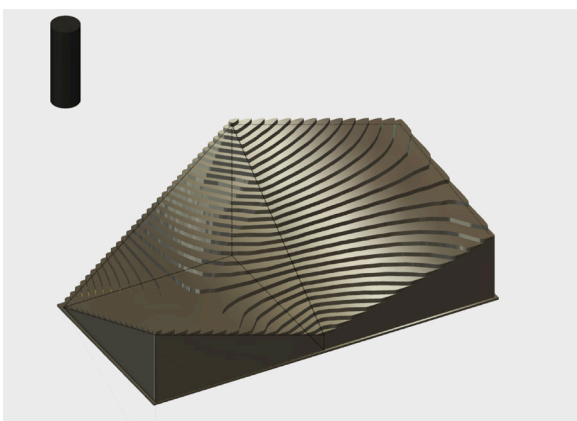
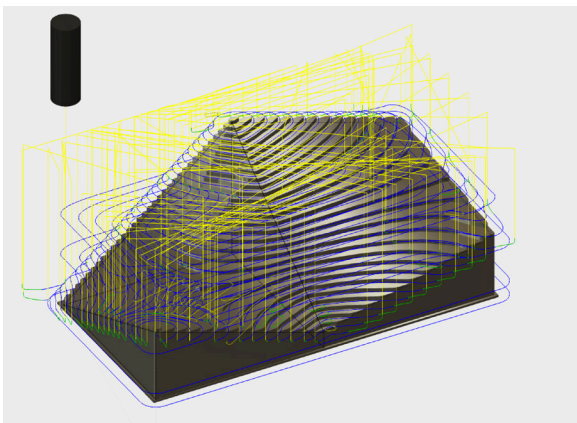
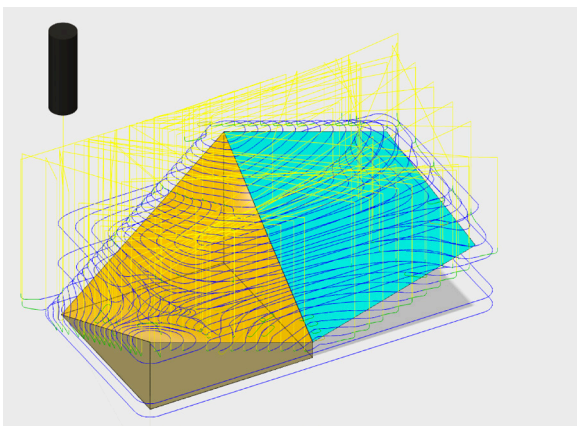



---

## Removing user error by design

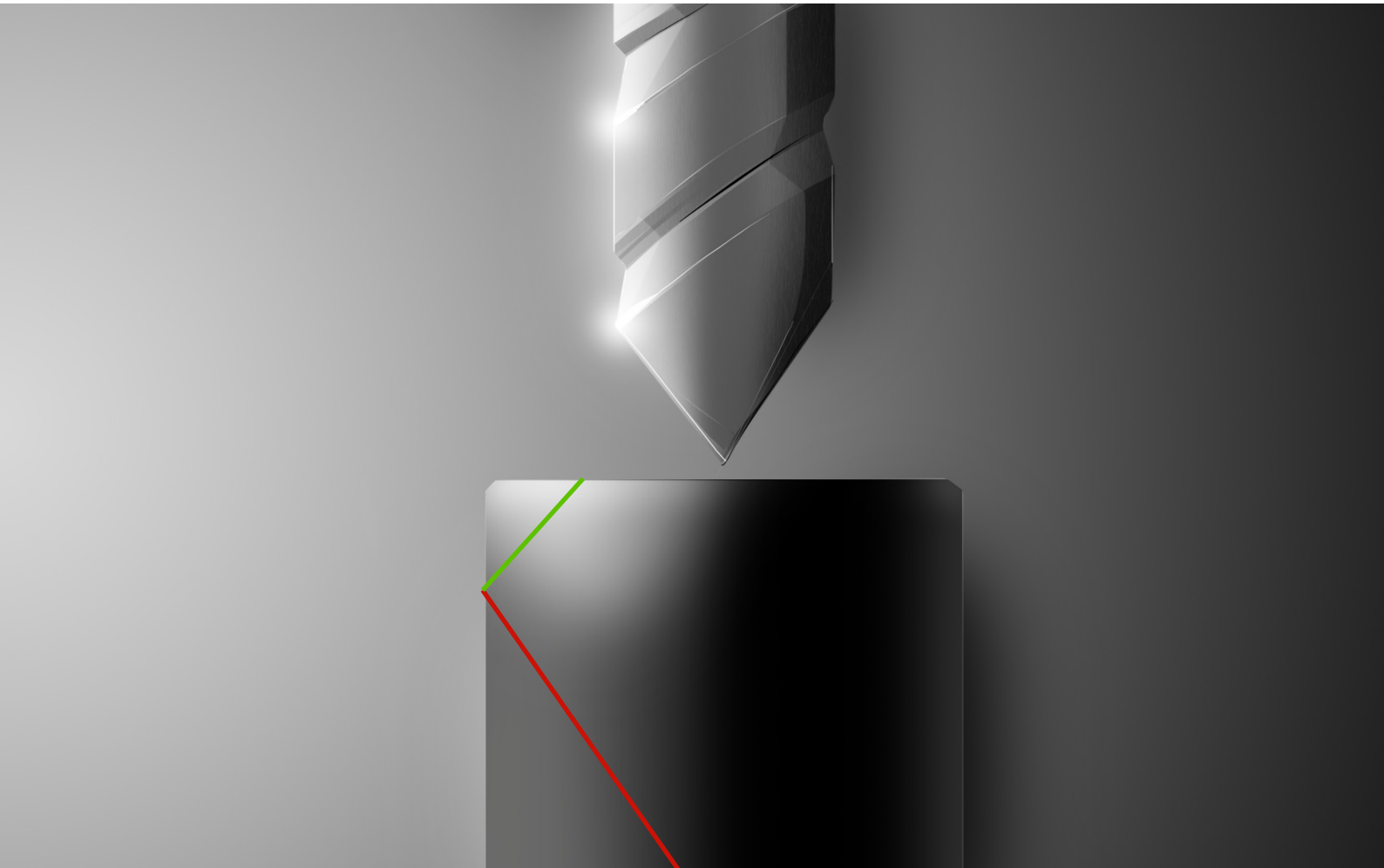

### **Ensuring problem free digital manufacturing.**

In regular 3-axis machining, overhang is impossible to machine. When modelling in traditional CAD software, there's no indication that the shape you create actually will become problematic before you enter the CAM environment.

TAD can't produce models with overhang. This removes the possibility for a model to fail during machining.

In the case of 3D-printing, complex models with overhang are reproducible, but by allowing for models with no overhang, you reduce the amount of failed print. Most failed or flawed prints are prints with either overhangs, or hollow models.

This is illustrated on the drawing on the right hand side.

## Designing with a physical connection

### **1:1 ratio - a direct connection to manipulation.**

When designing with screen based CAD software, you can define dimensions and units. Still, there's no way of knowing how large a circle with a diameter of 5 centimeter is.

A common mistake, even present in the industrial design education, is making things proportionally right in software, just to figure out cm, mm or inches has been mixed together.

TAD has a work area (X, Y and Z) that corresponds to the workspace of virtually every desktop cnc or 3d-printer available on the market today. The dimensions of TAD are 120mm x 10mm x 35mm. This equals the size of a 4" x 1 1/2" stock, readily available at the local wood supplier in meter lengths, for use when machining.

Compared to the suppliers of CNC-machines today who actually supply stock materials, a

120mm length of aforementioned 4" x 1 1/2" there might be a potential saving.

When using TAD for 3D-printing, there's also a 1:1 ratio. That means that a movement of 2mm in Z-direction equals the same in the 3D-printed model.

When TAD is used as a replicator, this also ensures a physical connection to the object that is being reproduced.

The blocks on the right is TAD approved



## KONSTRUKSJONSVIRKE 36X48MM

C24, Art.-nr. 08136148, Vekt/enhet: 3,1968 kg



Konstruksjonsvirke brukes normalt for å bygge opp stammen i en konstruksjon.

Vareinformasjon

Pris fra:

**19<sup>95</sup>**  
/LM

Velg butikk for lagerstatus

Ingen butikk er valgt

[KJØP](#)

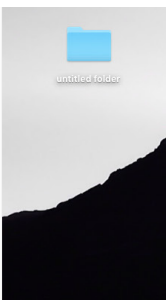

### Conclusion and reflection

This was a hectic, complex and fun semester. The rounds of user testing, and creating ideas based on interaction with digital manufacturing was a fantastic task. The end result got a form and expression I think cater to the intention Create and inspire.

To be honest, I've probably drilled 5000 holes, and sanded small 3mm metal pins a 1000 times during the last months. Especially prototyping pressure inside the large "functioning" model when user testing has been challenging.

What I think sells the concept to the children, is when they observe that their modifications happens on screen, at the same as on the model.

For a further iteration, an optional interface would be a priority. It does

not need to be more than a simple iPad with visual representation of the model in 3d-space. If the TAD in addition had an accelerometer connected, it would allow for viewing in different angles by moving the TAD you hold in your hand. By doing this you could get instant understanding of how surfaces on your planned model might look in different light(rendering on the iPad).

If this diploma was to be done again, a more functional large prototype should be built at an early stage. If you've first created the functional matrix, with the right pressure and movement, it's no problem to create a contained matrix that you can swap between ergonomic grips and shapes.

## Appendix

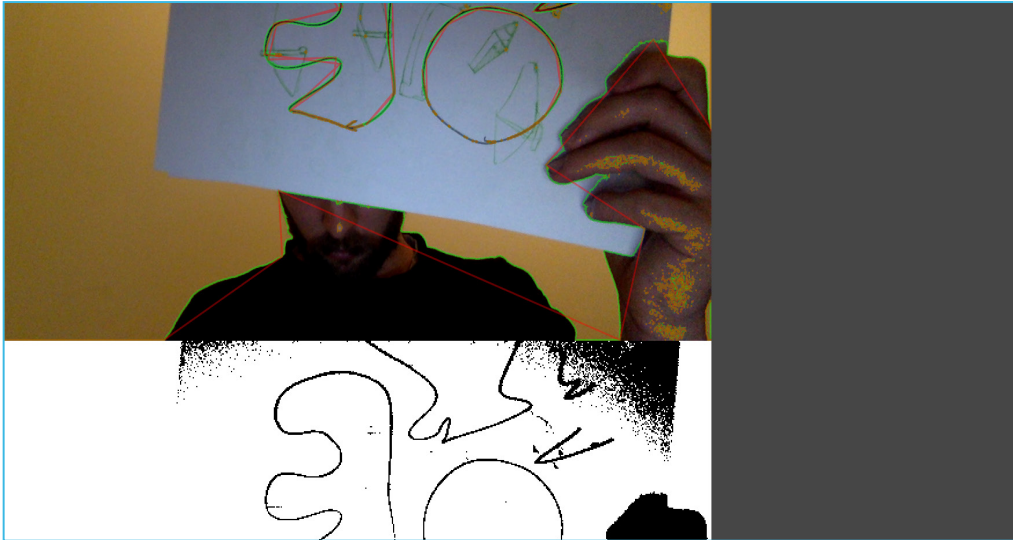

Some concepts that we're abandoned and but interesting enough to end up as functional prototypes during this diploma.

Linetracing - Each sketch is translated to a cut or pocket.



Self calibrating drill hats, allow for safe mounting of dangerous objects, together with color coded sizes.



This concept explores AR as tool for the interaction between human and machine. This was an incredibly interesting experience, as the data was dynamic and animated.

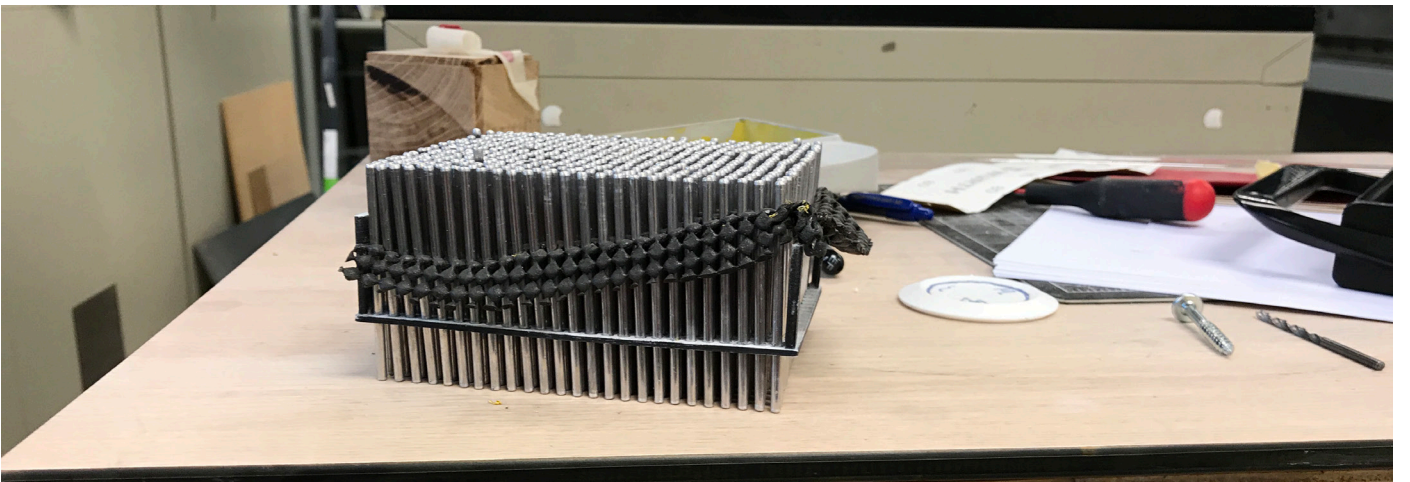
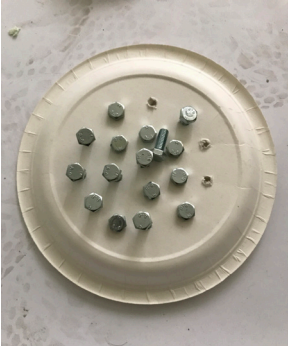

## Conclusions and reflections

### Creation

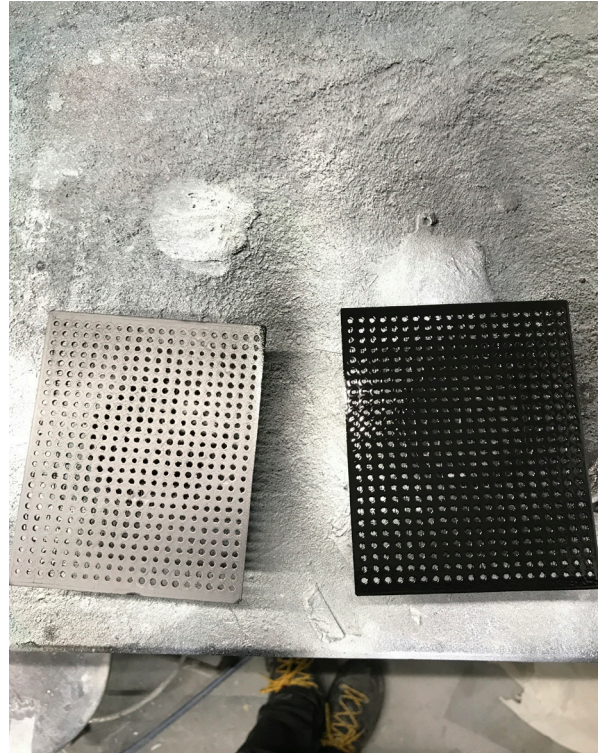

Every revision need 500 pins put in place, 100 holes drilled up to the correct diameter, and extra layers of paint on every corner. A time demanding task.

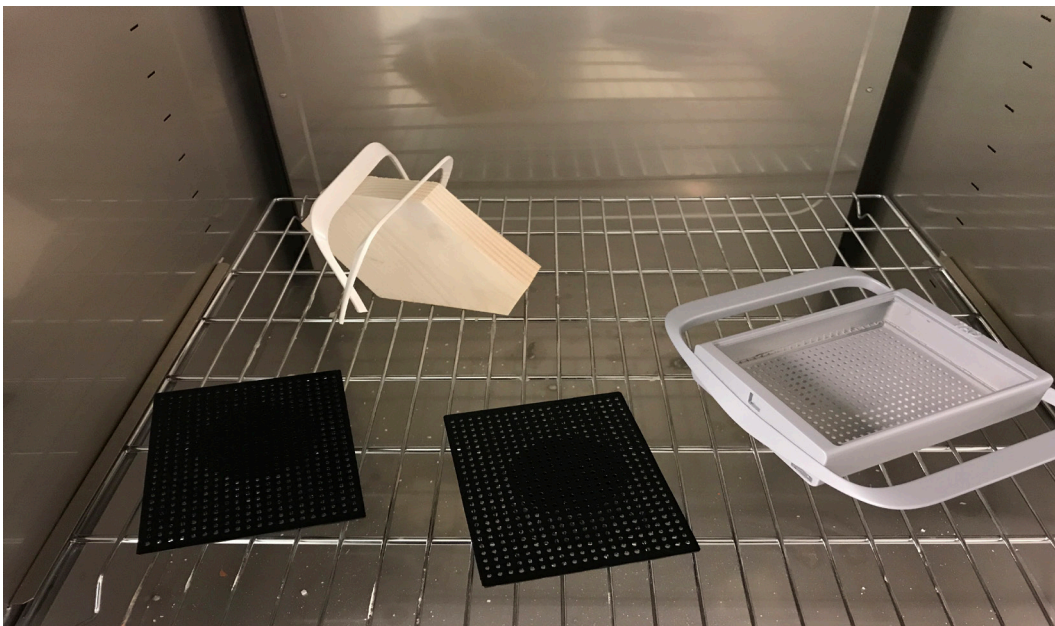

# Conclusions and reflections

---

## Sources

Diskusjoner startet av Ragnhild Moldstad Skavern i Hernes (2015) Available at: <https://moodle.elverumskolen.no/moodle/mod/forum/user.php?id=42&course=76&mode=discussions&page=8> (Accessed: 10 November 2016).

Kunnskapsdepartementet (2016) NOU 2015: 8. Available at: <https://www.regjeringen.no/no/dokumenter/nou-2015-8/id2417001/> (Accessed: 10 November 2016).

Gladwell, M. (2008) *Outliers: The story of success*. New York: Little Brown and Company.

UDIR (KHV1-01) (no date) Læreplan i kunst og håndverk Available at: <http://www.udir.no/kl06/>

KHV1-01/Hele/Kompetansemaal/etter-7.-arstrinn (Accessed: 13. May 2017).

Therkelsen, av H. and Therkelsen, H. (2014) Oljesvikten gir nye muligheter. Available at: <http://www.dagsavisen.no/innenriks/oljesvikten-gir-nye-muligheter-1.307112> (Accessed: 13. May 2017).

An inconvenient truth (2006) Directed by Davis Guggenheim USA: .

Roland Corporation, R.D. (2016) A history of innovation worldwide | Roland. Available at: <https://www.rolanddga.com/company> (Accessed: 10 November 2016).

Tools, S. (2016) Shaper origin: One tool, infinite possibilities. Available at: <https://shapertools.com> (Accessed: 10 November 2016).

Hansen, Hage, B., Digranes, I. and Ytterstad, B. (2015) Trearbeid og treverksteder i grunnskolen: Skolelederes verdsetting og prioritering sett opp mot tradisjon og fornyelse i faget Kunst og håndverk. Available at: <https://oda.hio.no/jspui/handle/10642/2712> (Accessed: 13. May 2017).

“Makerbot Thingiverse”. Thingiverse.com. N.p., 2017. Web. 15 May 2017.









