

PRESENTASJON 22.09.17

- ~~utgangspunktet~~ ~~utgangspunktet~~
- utgangspunktet mitt for oppsaven var en fasinasjon for industriell arkitektur og rommene disse maskinene og utrustet krever og var behov for. og da spesielt anlegg som blir last inn i tell.
- ~~og~~ ~~gjør~~ ~~gjør~~ Dette er som som ~~ikke~~ ~~er~~ ~~laster~~ ~~er~~ menneskelig dimensjonert og er i utgangspunktet ikke laget for mennesker og allmenheten i det hele tatt. De var nok sikkerhet og ser stort sett av de som arbeide der.
- Det ønsket derfor å lese et byss med en publikumsrettet funksjon i tilknytning til et slik anlegg, og at samspillet mellom disse to ville være interessant å utforske.
- Dette ~~forprosjekt~~ ~~besøkt~~ besøksentret er hovedoppgave hvor jeg ønsker å utforske de ~~forprosjekt~~ ~~utvikle~~ utvikle de ressurse slike anlegg følger

PRESENTASJON 22.09.17

- Besøksenter i forbindelse med Lysbått i Kvernhusmess.
- Utgangspunktet for oppsaven. fasinasjon de industriell arkitektur og rommene disse anleggene krever og skaper. Da kan de ~~ved~~ ~~de~~ nødvendige ~~til~~ ~~montere~~ monteringsarbeid bli prioritert.
- anlegg ikke laget for mennesker og følger ikke menneskelige dimensjoner.
- Besøksenter i forbindelse med dette.
- Lysbått? Kvernhusmess skal leses med. En Hall Konstrukt i 1952... etter krystiden.
- Komme og lokale områder som "verdensdel"
- Lysbått info. veier, brit osv. verdensdel 100.000 i året.
- ønsker å undersøke og utforske ressurse og logikken til ~~gjøre~~ ~~dette~~ dette anlegget. matrisiteteten. teknologien og det ~~vanlige~~ ~~anlegget~~ anlegget og hvordan dette kan omsettes til arkitektur. og hvilke romlige kvaliteter dette kan skape.
- prosjektet mitt skal være av liten skala.
- Stoko quo: Ikke kommet helt dit jeg ønsker. men ut noe 19 er fi vei. mi dahlere skoleber.

- Heidegger. things become space for people space of things.
- things become animals.
- Scott Brown. duck, near figures.
- things don't fit.

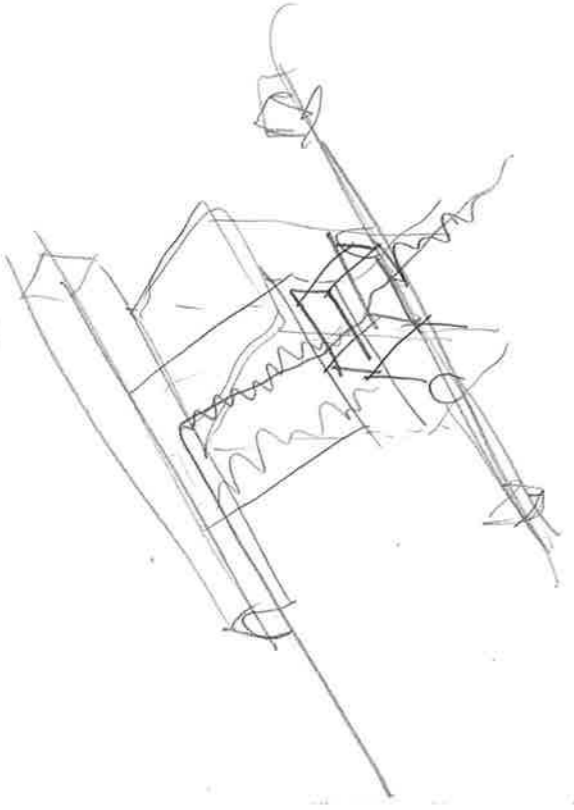

- Regeneration:
- word: kein Plan, kein Programm.
  - kein Programm, unter
  - Plan was mit Programm, es nicht mit dem Festlegung
  - nur für ganz leicht für möglich
  - Programm: eher "vor tyliche" Besatzung + Flexibilität es war in Leslie.
  - besep. was muss nach besetzter?
  - Probe rüber was ist eine programm als architektonische und seine Bestimmung
  - für Fall in: Bgm. Renne fallen. Was kann set come?
  - ex common or grant it as light for master, interessant
  - architektonisch
  - Bgm inspiration as unkonventionelle, Kollaboration, diplomatisch, improvisation.
  - des things are work.

The public is involved with creating and interpreting architecture in its broad, social, cultural and historical perspective.

Corbusier - Towards a new architecture. man über om at set; here i day her som on modern. Huset as an modern.

Paul Sheppard's artistic love - a story of machines and architecture. (Machines are the sculptures of today.)

SAMA. Utenbers

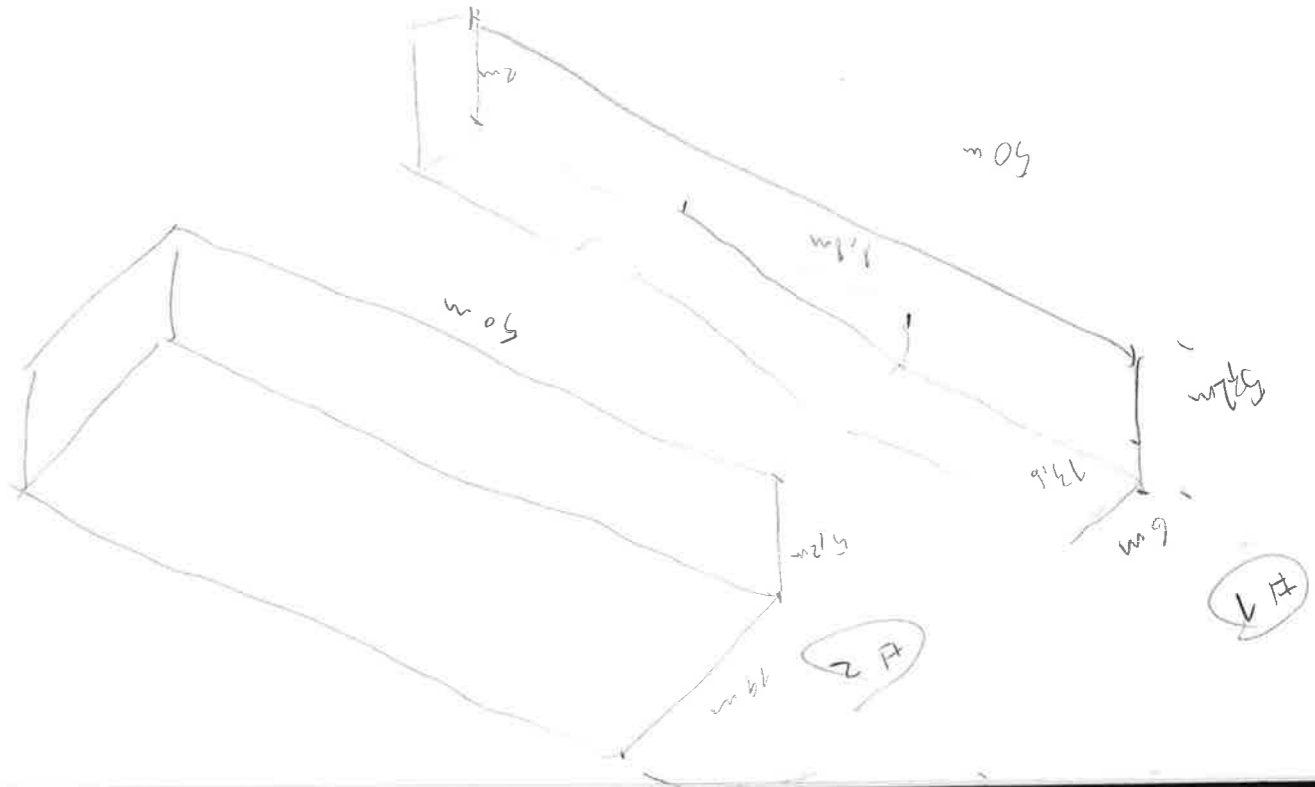
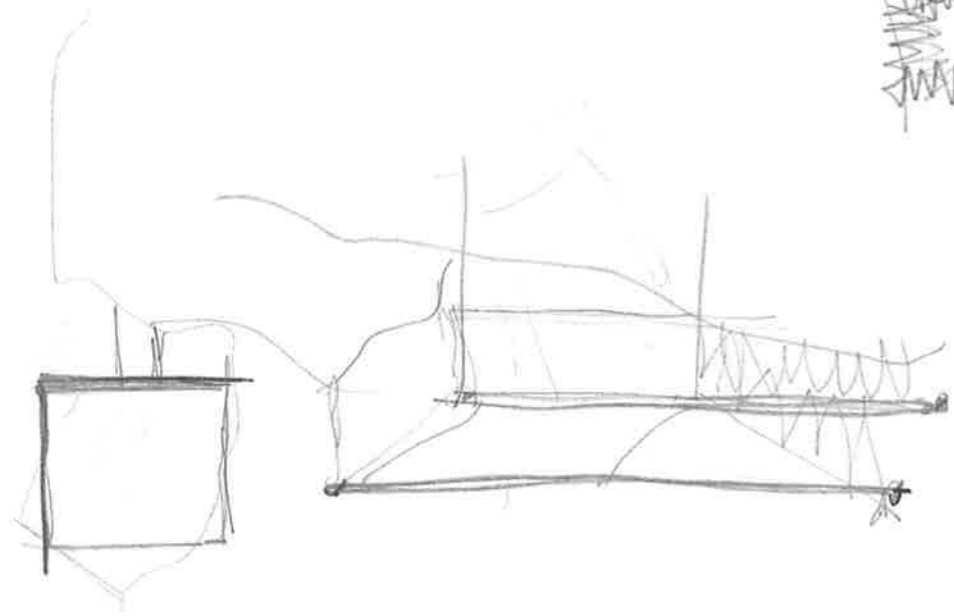

- UML
- 40
- 41
- 42
- 43
- 44
- 45
- 46
- 47
- 48
- 49
- 50 - Lamin.

- Do do um wo.
- Mellon - fröhliche studie
- evs'scheite wasser, lastless
- as elementar 1 plan of
- erregung 1 hebräer.
- Transmitter rom, plan/schnitt
- ~~verabli~~
- Mann - utop
- Star gänge
- test kammern.
- verus heb.
- ~~erregung~~
- vaper furtell.

die studie in Hellen i wach  
 Helle die Prozess!!!

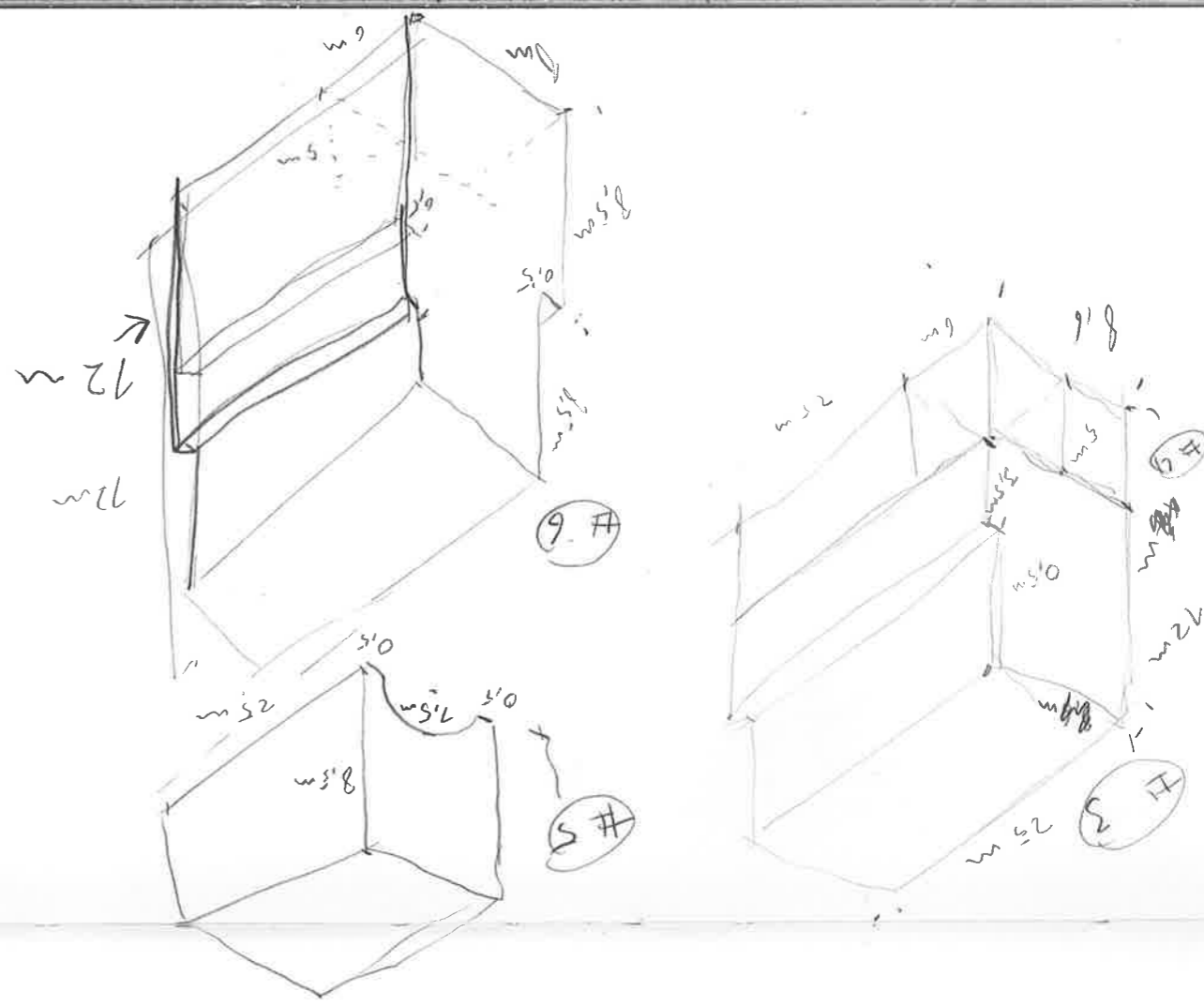

Hovedoppgave 7/11/2

- 2-sources m/ 2 sensor

- Felles opphavsrom m/ bygningskode

- Proriantliggør + terrengrom for skoleklær

- Skolebygget: mindre kombinert opphavsrom m/ sensor og en toilet + lagerrom

- en bil er vist for de fire videre

24+

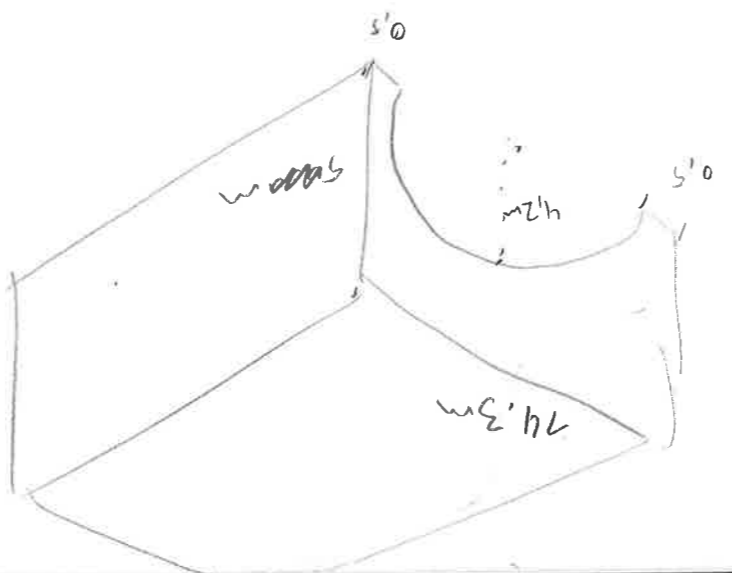
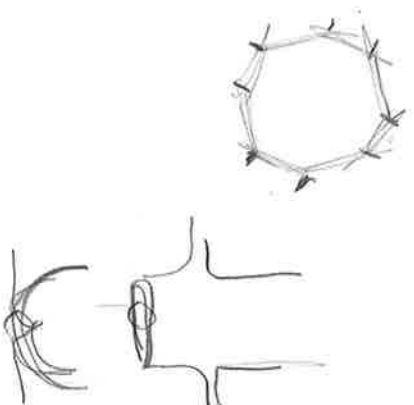

1

modell: 1:250

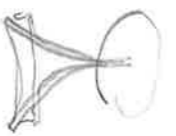

Plan for 2-egget

- Ruvings bil, prov å legge sensorer i

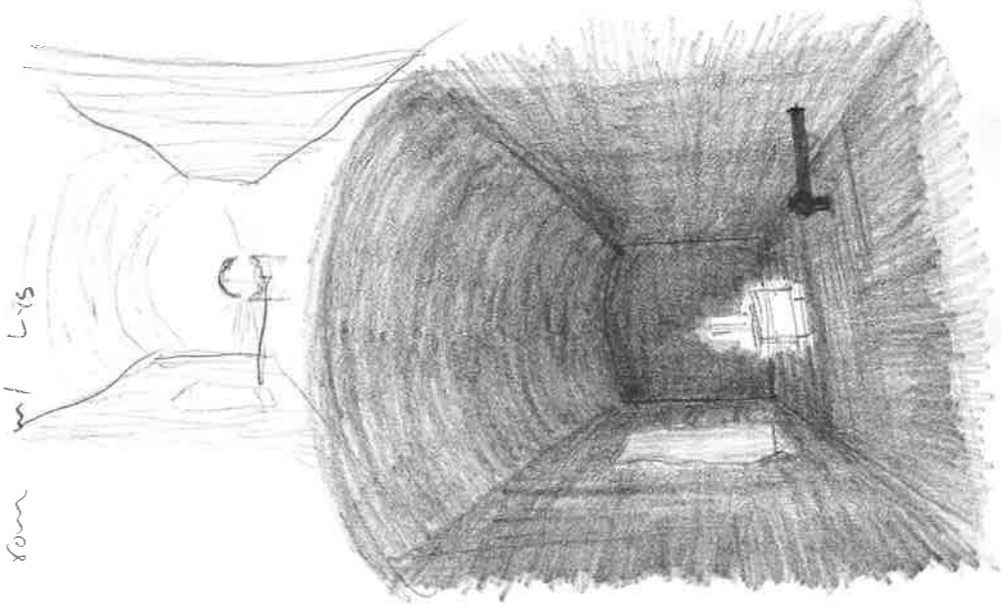

- light ray beams

Euclid and Ptolemy - Ray diagrams that show how light bounces off a smooth surface or bend as it passes from one transparent medium to another.

- Geometrical optics - Ibn al-Haytham describes vision as a process involving light rays bouncing from an object to a person's eye. Pinhole camera.

- Christian Huygens (Dutch mathematician, astronomer) "treatise on light" wave theory. speculated on the existence of some invisible medium - an ether - filling all empty spaces between objects. He further speculated that light forms when a luminous body causes a series of waves or vibrations in this ether. These waves then advanced forward until they encounter an object, eye.

- Light as rays:



Reflection

smooth surface (law of reflection)

"the angle of incidence equals the angle of reflection"

On even surface = scattering (paper)

# Refraction



- occurs when passing from one transparent medium (air) to another transparent medium (water)
- change the "normal" line (Boards)
- the amount of bend or (angle of refraction) depends on how much the material slows down the light. (index of refraction)

- Thomas Young's (double slit experiment)

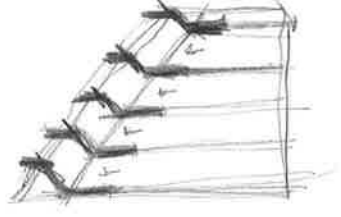
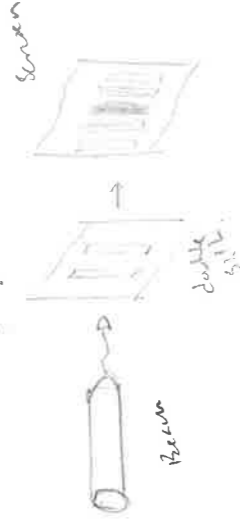

To do come over:

- Define program. "it's not in the, outside"
- 75 km + 100 like bed.
- Plan facilities. Spreads + last summer
- + floor 2m for hole was the variance of
- be resistible machine?
- Asbest?
- working with light in a dark space.
- Press bar. 4000 ea or brick.
- Illustration?

# PROGRAM.

+ hotel

Source room + bar.

Forskellige størrelser 0,1 m osv. + 2, 10 m osv.

+ kjenner + restaurant land

spi avdelis

- varmer (us) kullp

- dampbad

- dug it generate.

to 40 km.

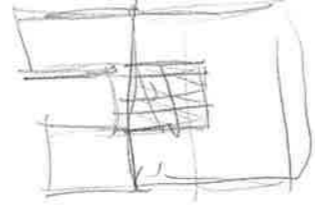

1-1/2 m osv

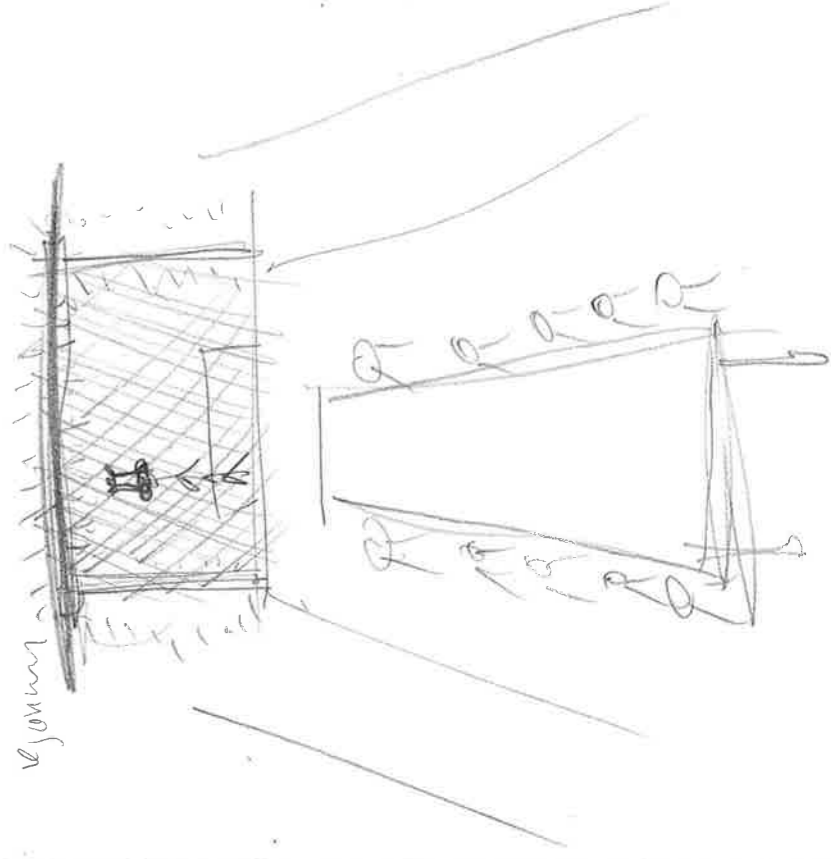



Area

Store hall:  $2000\text{ m}^2$   $73,5 \times 27$  m

Like well:  $5,3 \times 130\text{ m}$   $689\text{ m}^2$

TRANSFORM ROOM 2:  $90\text{ m}^2$   $\times 3 = 270\text{ m}^2$

TRANSFORM ROOM 1:  $132\text{ m}^2$   $\times 3 = 396\text{ m}^2$

VENTILATION:  $123\text{ m}^2$

GENERATOR:  $274\text{ m}^2$

NEW OFFICES:  $725\text{ m}^2$

TOTAL:  $3817\text{ m}^2$  (ca  $4600\text{ m}^2$ )

Method analysis.  
diploam. guide of content

Specific workshop.  
by size we can have 3000 m<sup>2</sup>  
to fit, architecture, set pt, life, workshop.  
we can visible.  
- architecture of sensors.  
- Floor slabber guide. diagram over the plan.  
- def. a new layout.  
- details.  
- To answer for let some environment. like a table.

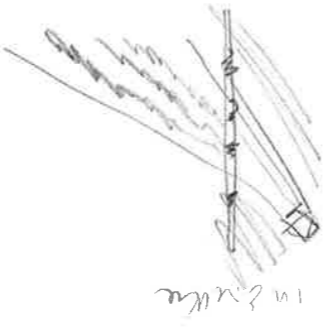

Rules

Generator Well:  
 $73,5\text{ m} \times 160\text{ m} = 2000\text{ m}^2$  (H:  $7,5\text{ m}$ )  
6 machines  
W:  $5,5\text{ m}$  L:  $74\text{ m}$  H: maximum  $+ 8,66$   
SHOULD NOT BUILD BIGGER THAN THIS. THE ROOM IS  
built for these machines, and any other big  
intervention could ruin the feeling of this  
room.

VENTILATION HALL  
 $5,3\text{ m} \times 130\text{ m} = 689\text{ m}^2$  (H:  $7,3\text{ m}$ )

6 machines "hidden" in the floor at certain  
places, connected to the generators.  
This well is almost completely clear, only  
valve visible.

TRANSFORMATION ROOM 1.

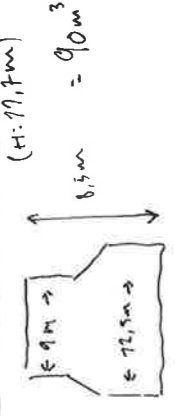

15 three of them.  
Total:  $270\text{ m}^2$

TRANSFORMATION ROOM 2

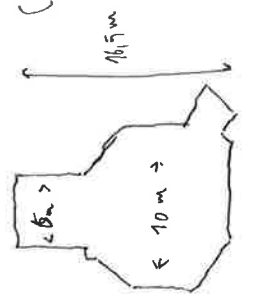

15 three of them  
Total:  $396\text{ m}^2$

Workshop

Area:  $10\text{ m} \times 72,3\text{ m} = 723\text{ m}^2$   
located along the entrance walkway.  
Height:  $3,8\text{ m}$

Entrance:  
 $42,5\text{ m} \times 5\text{ m} = 212,5\text{ m}^2$   
Long and small.

ESCAPE ENTRY  
 $301\text{ m} \times 3,4\text{ m} = 1023,4\text{ m}^2$

entire floorplan same scale.

Stille malen input made room as messer.

Figure of plan 1+2. (1:200)?

- tk ut noon shift. (1:20)

- Beschriftung planer →

- evtl: Illustration

18:30

18:45 → 20:15 → snitt / vandrings

20:15 → 00:00 → plan

SYNOPSIS  
26.6.17.

DRAMATIC

Subline:

Show what; choose to show.  
Impulsive shadow - Japanese culture  
shadow and light.

- experience how to be in a room space.
- Dawn. Graffiti.
- Balance nature.
- light line. sp. electricity.

Tabbe vidue med lykt os marerdt.

disse tingene phaset ned.

- i alle hvide boder - pensivt.

toilet same com

hvide? brode med.

Lis i vsm. brode med i kset.

Modulering

isomogram

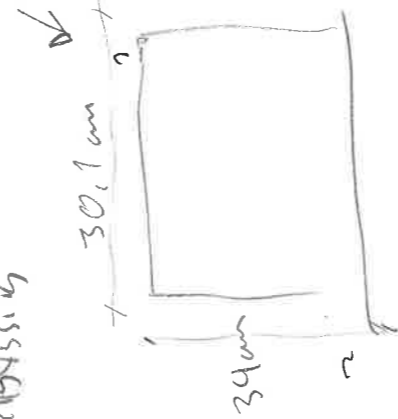

1 Side planer + 2

$$27.5 + (\text{side planer} + 1.2) + 1.2 = 29.7 \text{ cm}$$

30.1 cm  
L: P

$$27.5 + 1.2 + 1.2 = 29.7 \text{ cm}$$

$$30.1 + 1.2 = 31.3 \text{ cm}$$

Toilet hours.

A small interior space, dim light from inside when used, only entrance light up when it is not used.



- lifted above ground so the infrastructure can be underneath.

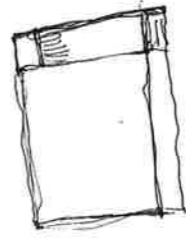
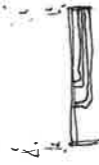

- not necessarily, either one window that expose the light outside:



OR

A translucent material that shows the shadow.



Planless framework: Production of projective...

Design i network.

Sanctuary

- kuller: hva betyr min?
- folk: te der fram i hallen
- folk: hva sier min for? hvordan leses min frem.

↑ i fra skulptur: de upåle 10 minner, de 15 år rommer, de mist mellom.

Walter Gropius

Concept for walk ways:

Two types of underlay:

- ① concrete. Flat & recognizable
- ② stone. uneven and unpredictable



These are ~~already~~ already inside the wall.

How to light?

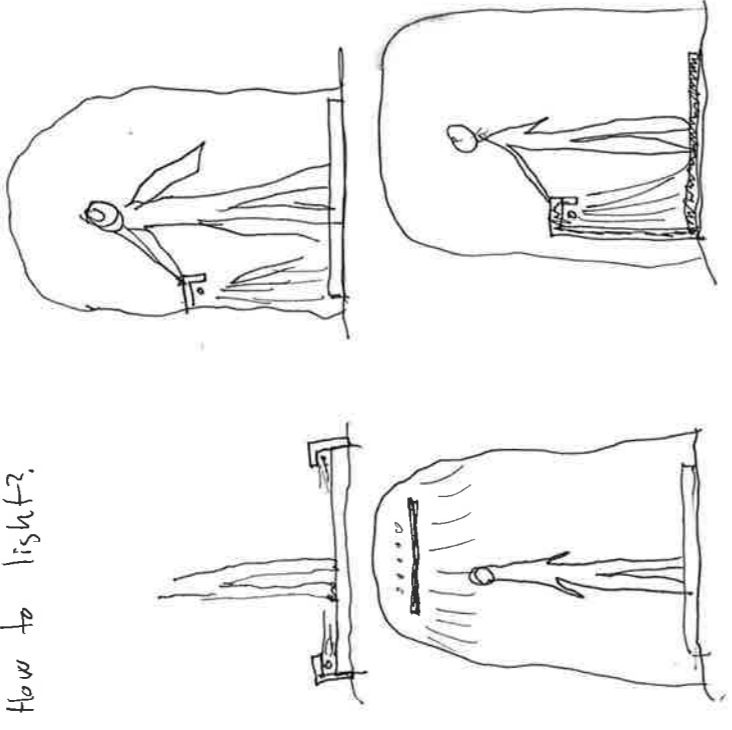

Purpose of the leading light?

- Show boundaries and make sure they don't do any missteps.
- lead the way between functions and spaces.
- Differ between leads and stops?

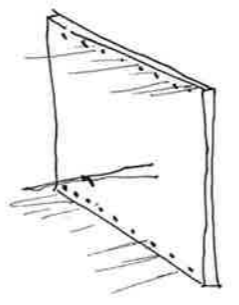

leads



leads



stop



stop



TOALETTER.

- 1 toilet for 15 women } the role
- 1 toilet for 20 men. } (KO-organization)

in connection with sleeps in 4 toilets  
 --- " --- spa : 2 toilets

--- " --- with restaurant: 2 toilets

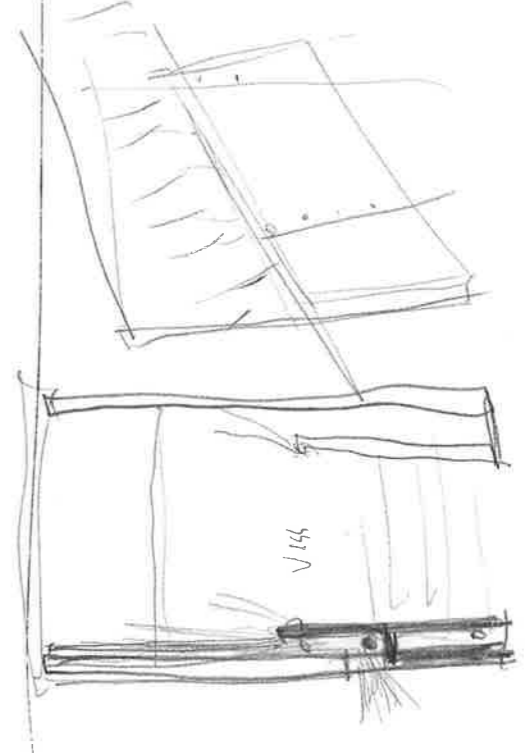

put it wall element

type 1.



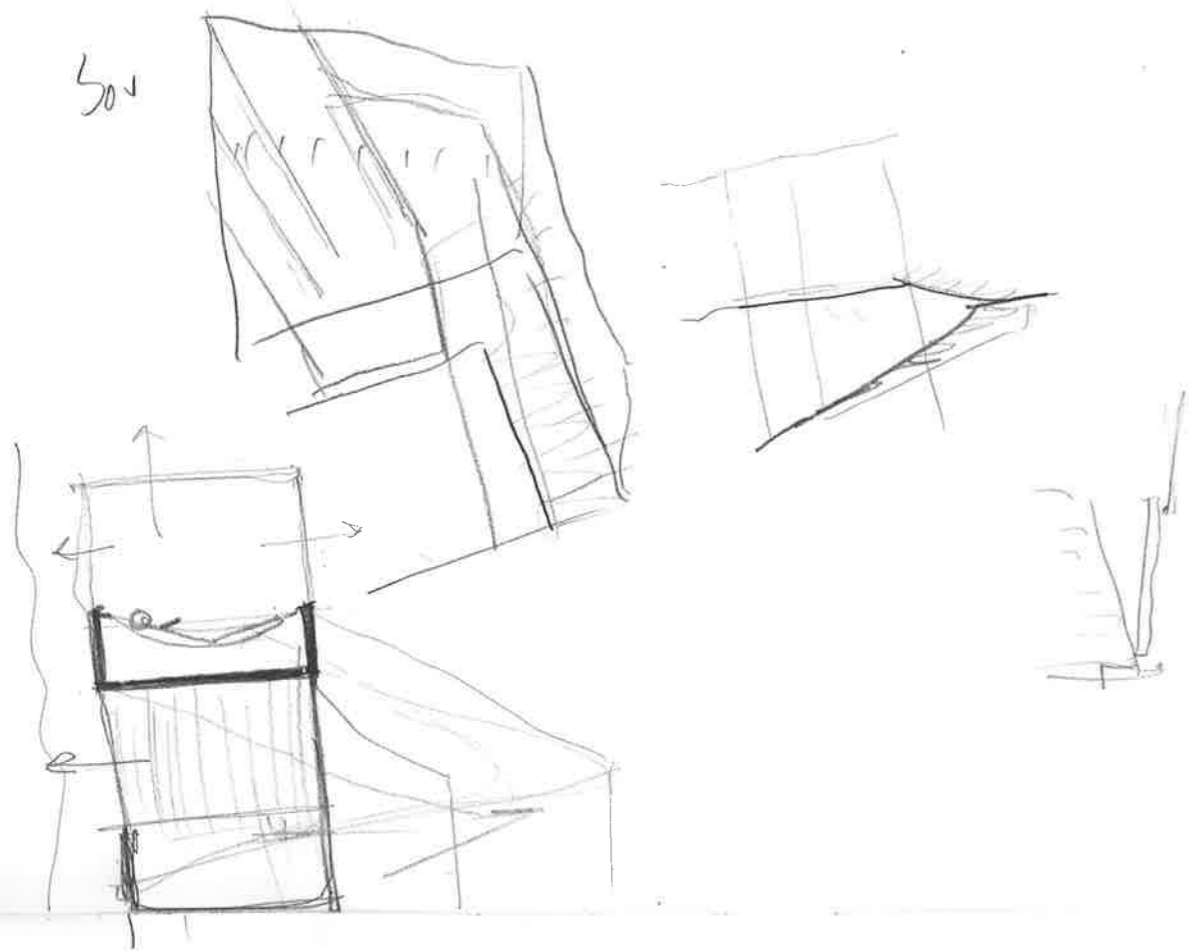

Two underlays / walkway

①

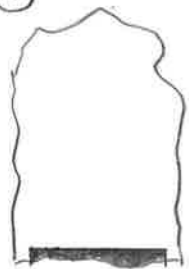

- Flat covered in dark areas where you need a steady underlay.
- In areas where you are guided around the complex.

②

- Natural rock ground, existing.
- used between walkway and functions.
- in areas with more light.

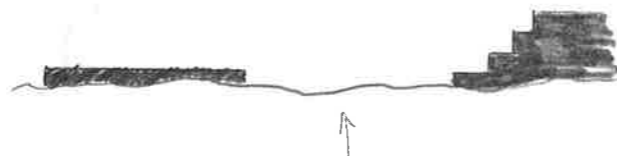

TRAD.

- Dvoj i Garžarok, Lysspa i Dampbad,
- Vannstave

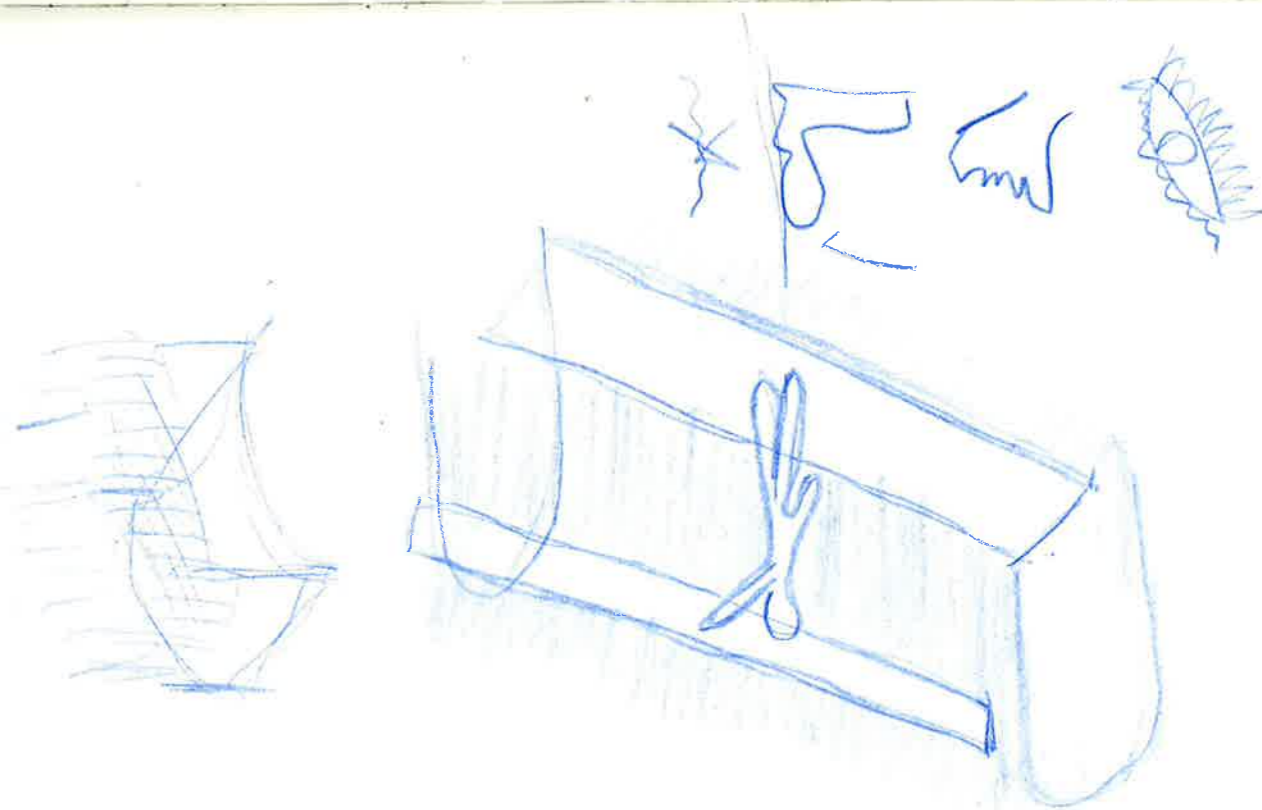
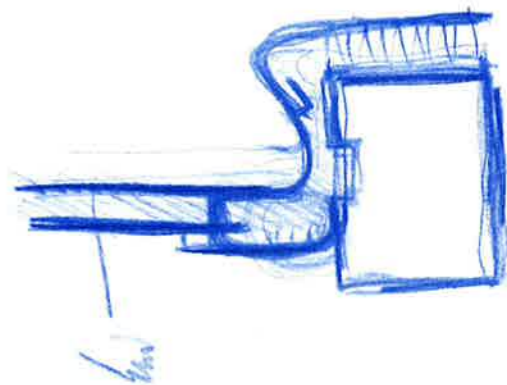

only the most necessary

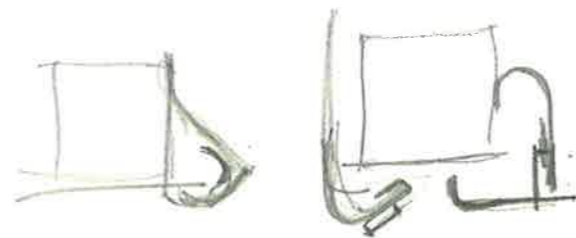
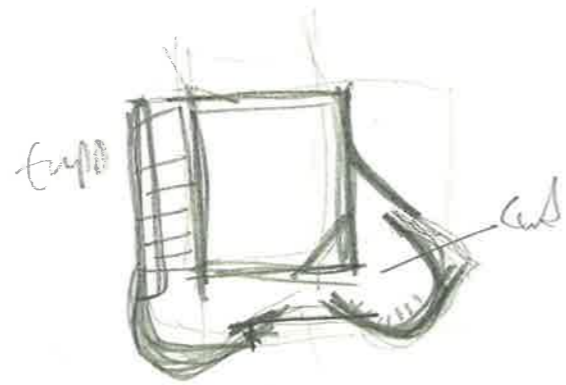

How to build something you don't see.

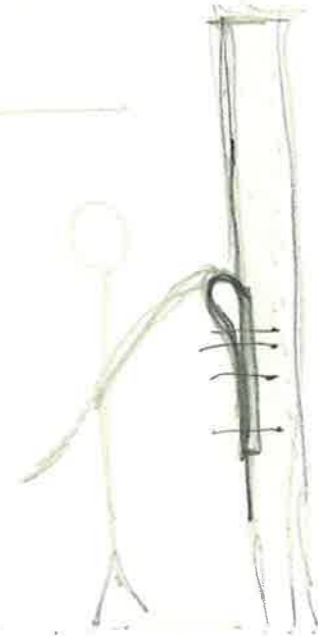
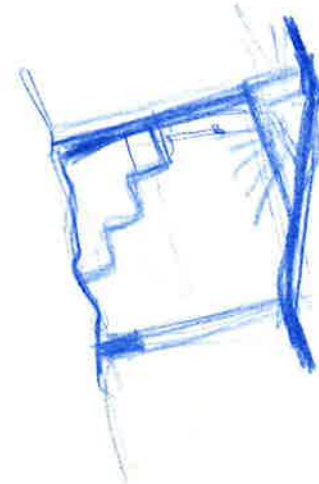
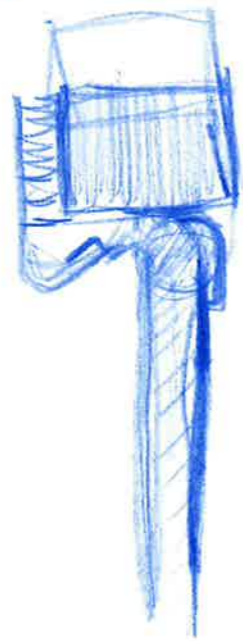
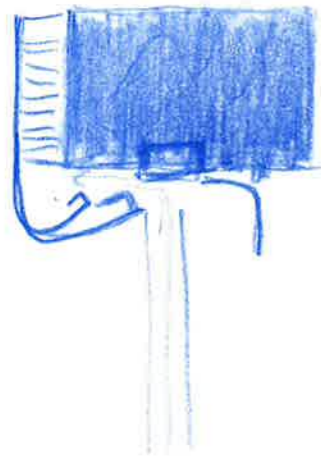

How to create architecture you don't see.

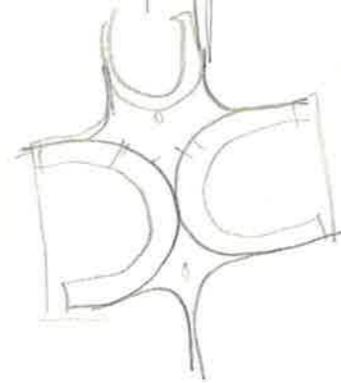
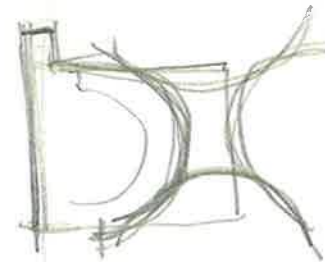

Only the most essential  
 Close spaces: for quizzing in wash.

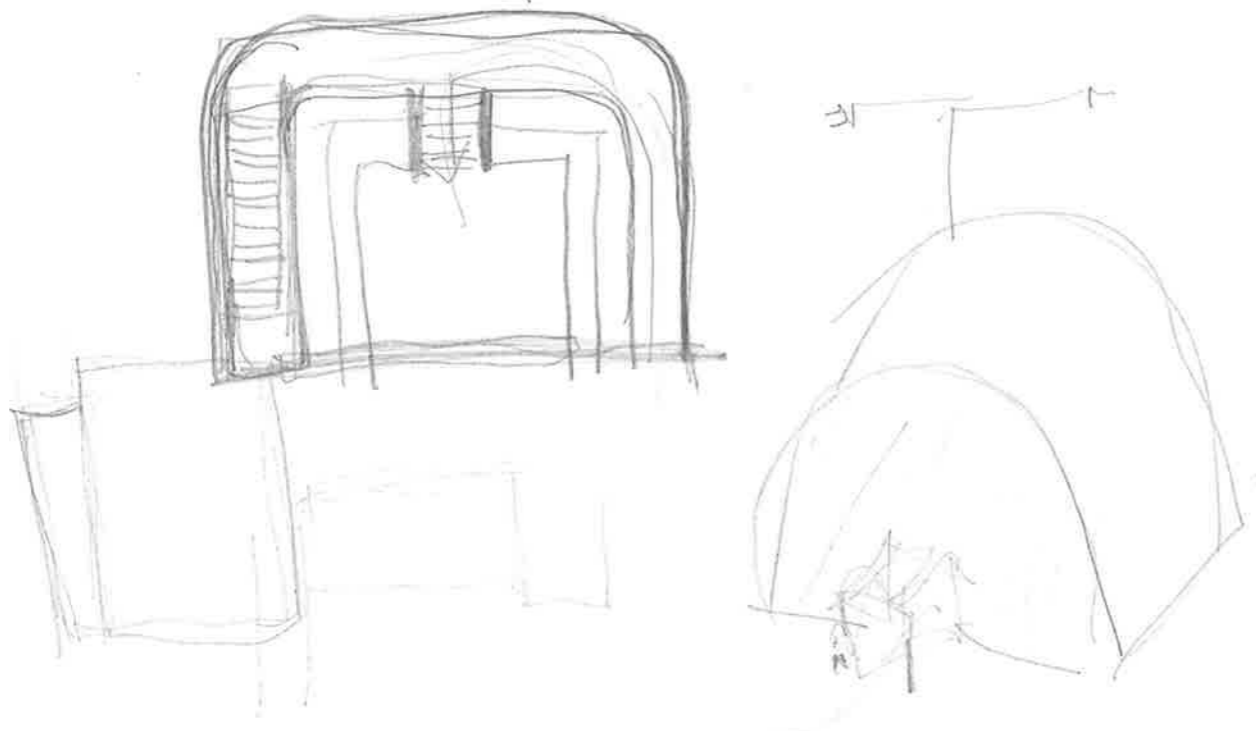
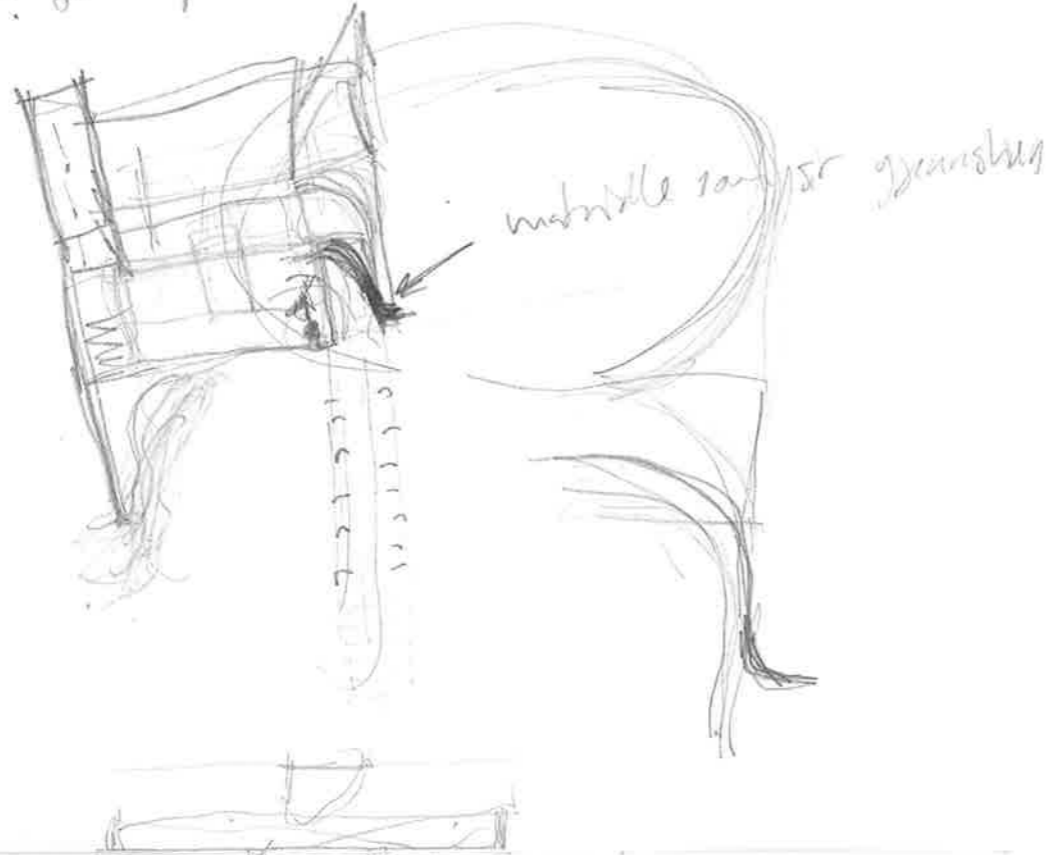

BADSTU

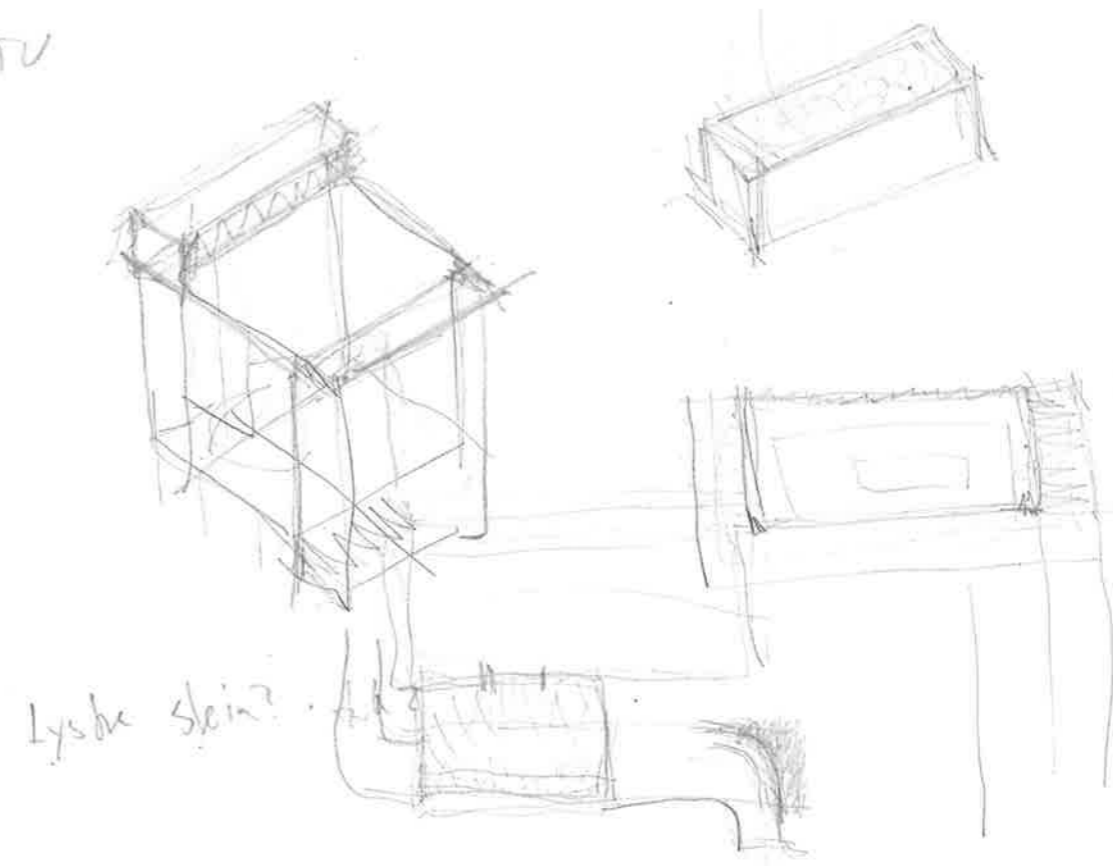

Sauna: - Kungsser hi is with Mervin  
 - close to toilet  
 - close to shower

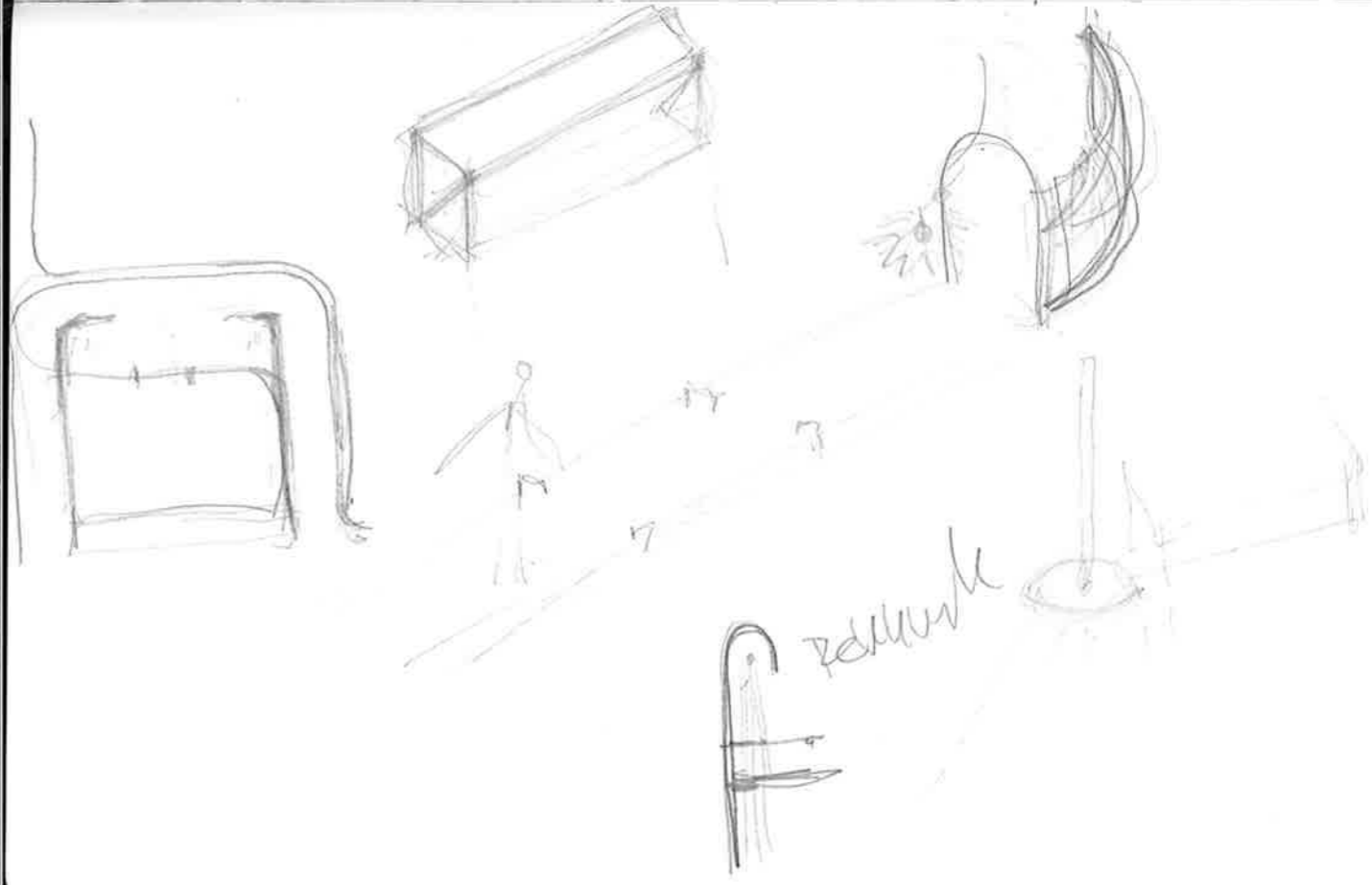

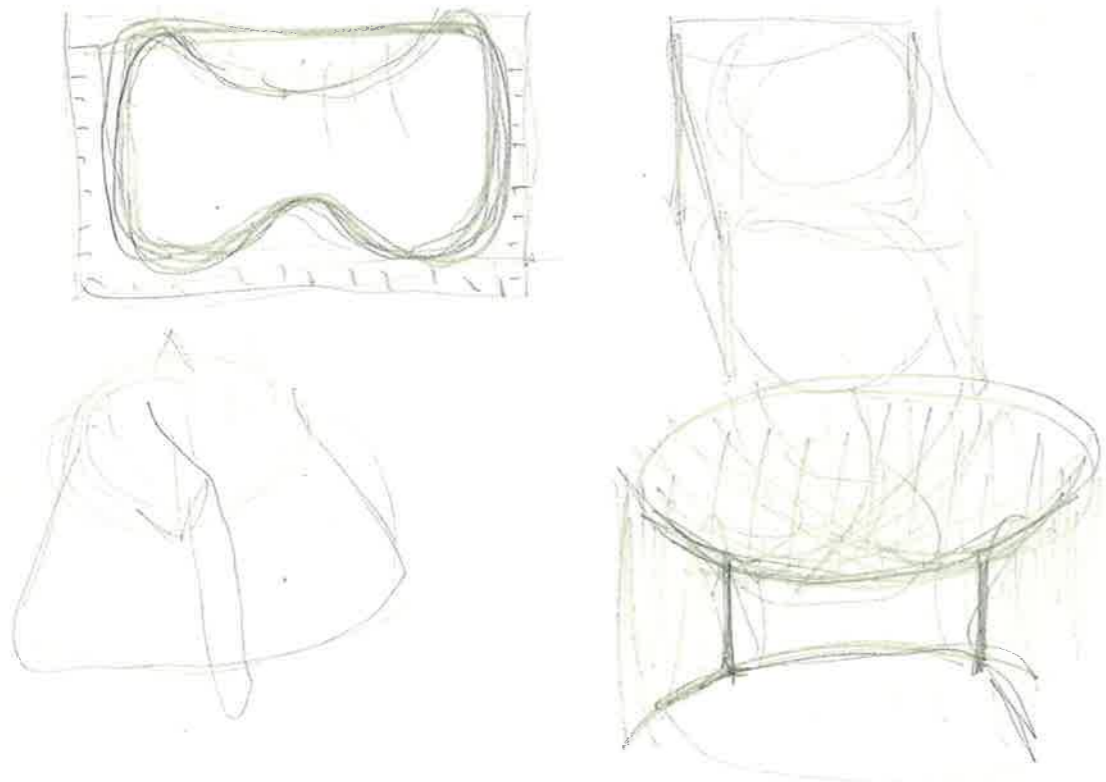

Tid i magen

- walkway, □ DIAGRAM
- spa, subway, □

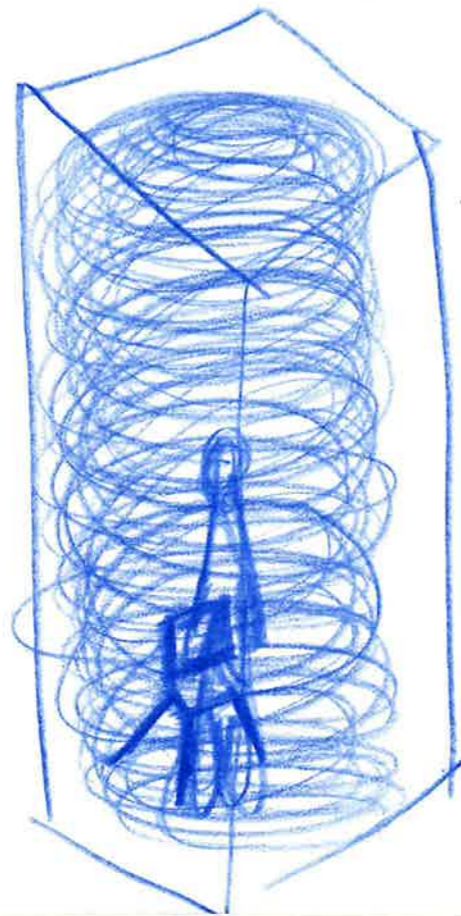

lightroom

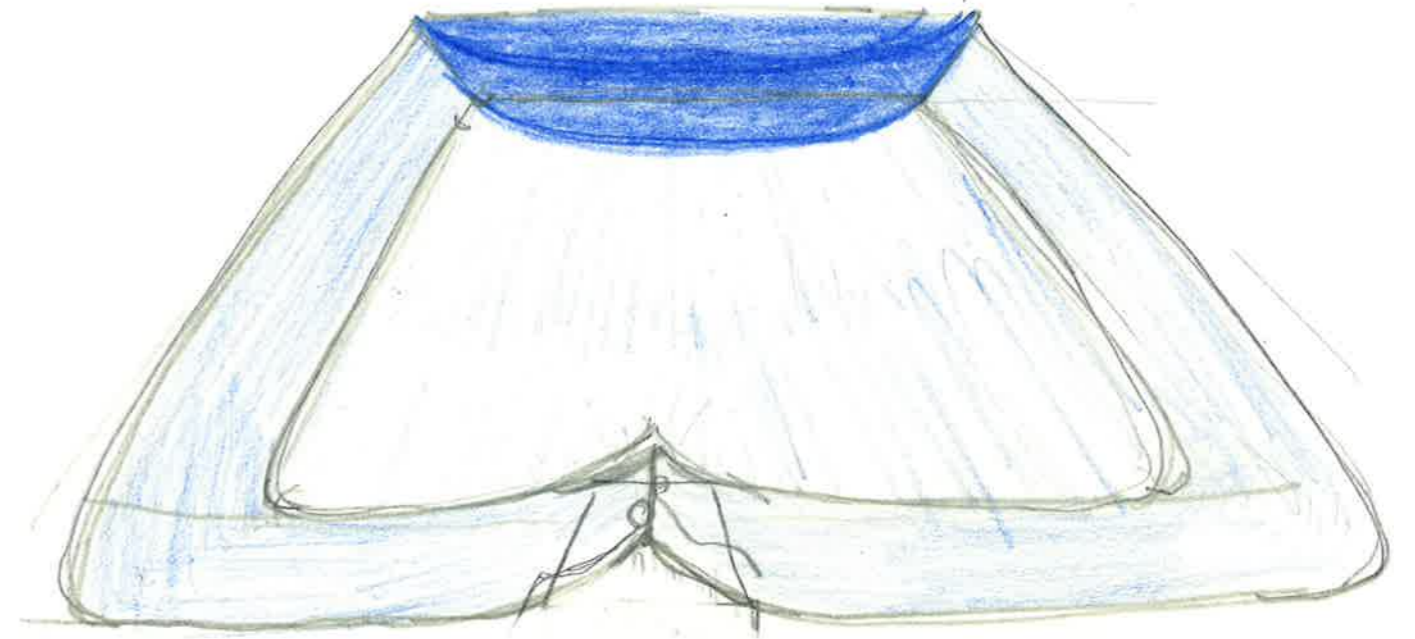

A room that gives no shadow. ↑

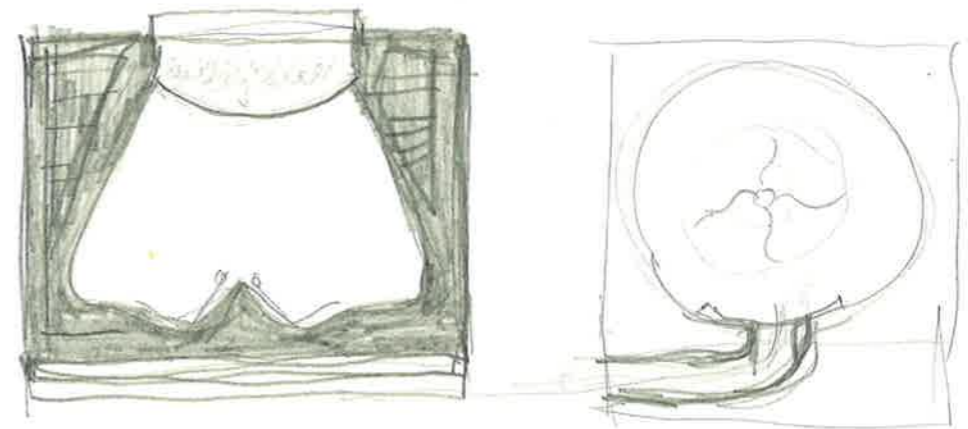

# Light spi

Function: a completely light up room in this dark hall to stimulate the daylight?

James Trull ♥

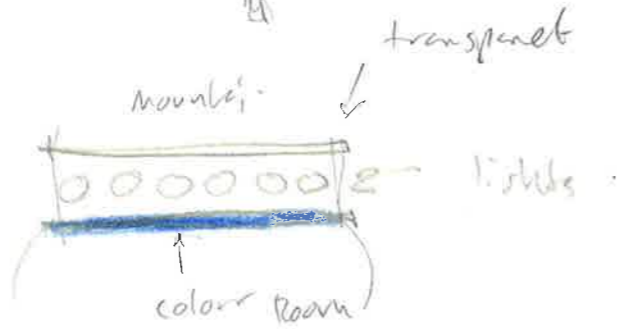

Round shapes to work as a completely contrast to the hall.



- Ikke konvergerende: Da Oblegges stedet.

- Husk hvilke vægner som er her!

- Tur gæne, klædrene, badeværelse, campingtrailer.

- sovesel? Bunkbeds? noen private rom + noen fællesrom.

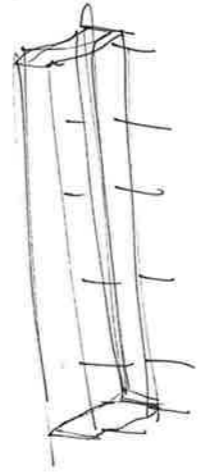

Hvordan kan jeg lægge væg?  
- Hængt i  
- Sænket?



Spør:  
• Hvordan forholder jeg mig til rummet? Hvilken rum?  
- Hvilke rum har jeg lyst til at bygge eller bygge jeg som elementer i rummet?  
• materialitet?  
- Hvilke er materialer i boder? Stel? betong?  
Også min jeg jøke med dette på en måde som gir transparens. Hs.  
• Hvordan organiserer jeg dette?  
- min  
• Hvor skal væg være?  
Turisme, badeværelse, fællesværelse campingtrailer.  
• Hvor skal opplyses?  
- min sove (hvis) rum spise (hvis)  
- Hvordan min ses ut noen steder?



- 1010 kv, flokkido 26 rom

RESPESSON. Forrom, EN vein, STYRROM, FORHETT

123 m<sup>2</sup>

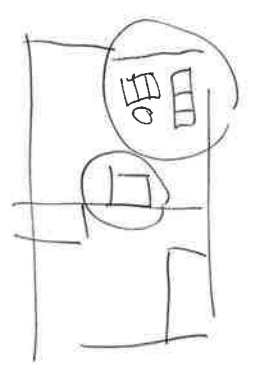

Konferans

Service / INNGANG VITJENOM, PENSJONROM  
Kydrom forbielde m / kyddom.

RESPESSON:

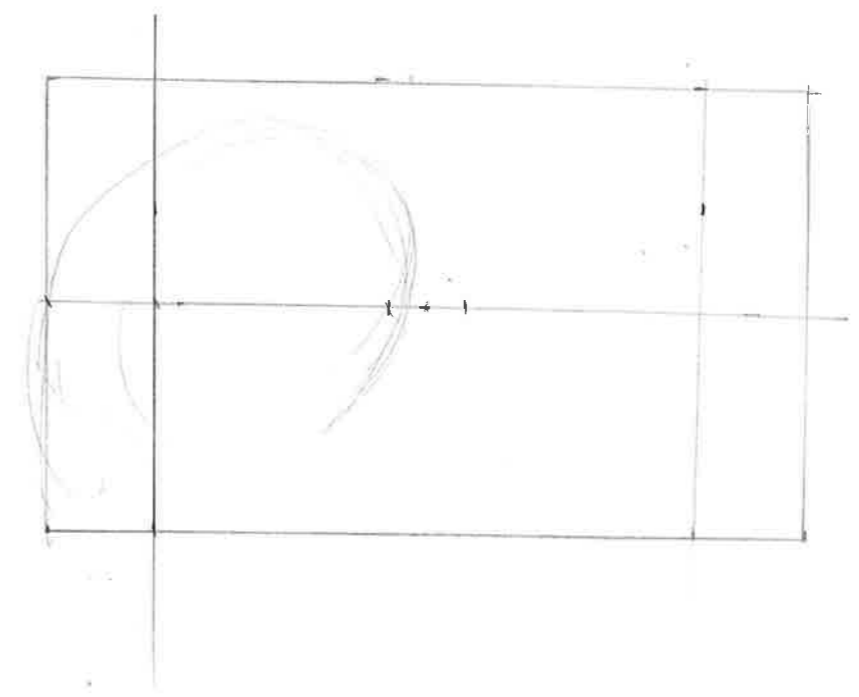
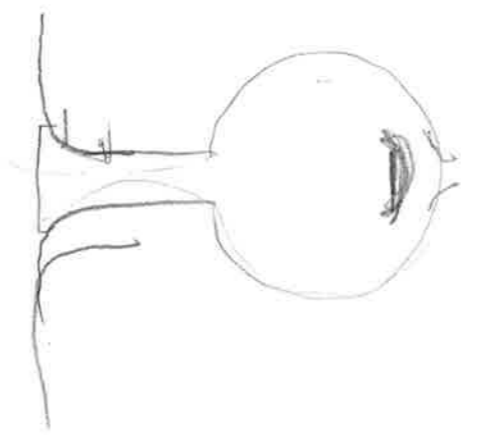

Hvite Nivåer?

- Nivå + 2.00 = Rummet av fjellkell ✓
- Nivå + 3.10 = Halvniå opp = gangen i underkjeller + grunn på stabilt kull ✓
- Nivå + 3.66 = inngangen + opplystet til etg. ✓
- Nivå + 17.25 = hvelutakk
- Nivå + 18.5 = kabeltunnell
- Nivå + 20.5 = taket på fjellkellen.

Level 1 ↓

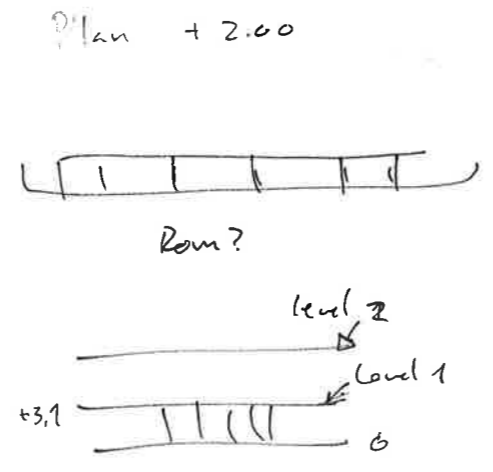

TIPSATA:

Fokus på Plan + snitt. 3 snitt = vit + 1 lang  
= planar.  
= grunn + forste.

MANDAG:

Fokus på PLAN OR LYSKONSEPT!  
NIVÅER.

- Isomometri over kullen? Lettelse i forståelse ikke nødvendig men lurt.

- Skytterne over unskinner + mine funksjoner!

- Plan forståelse

TIL PIN-UP TOSDAG:

"BAOY 255"

elt was for bus

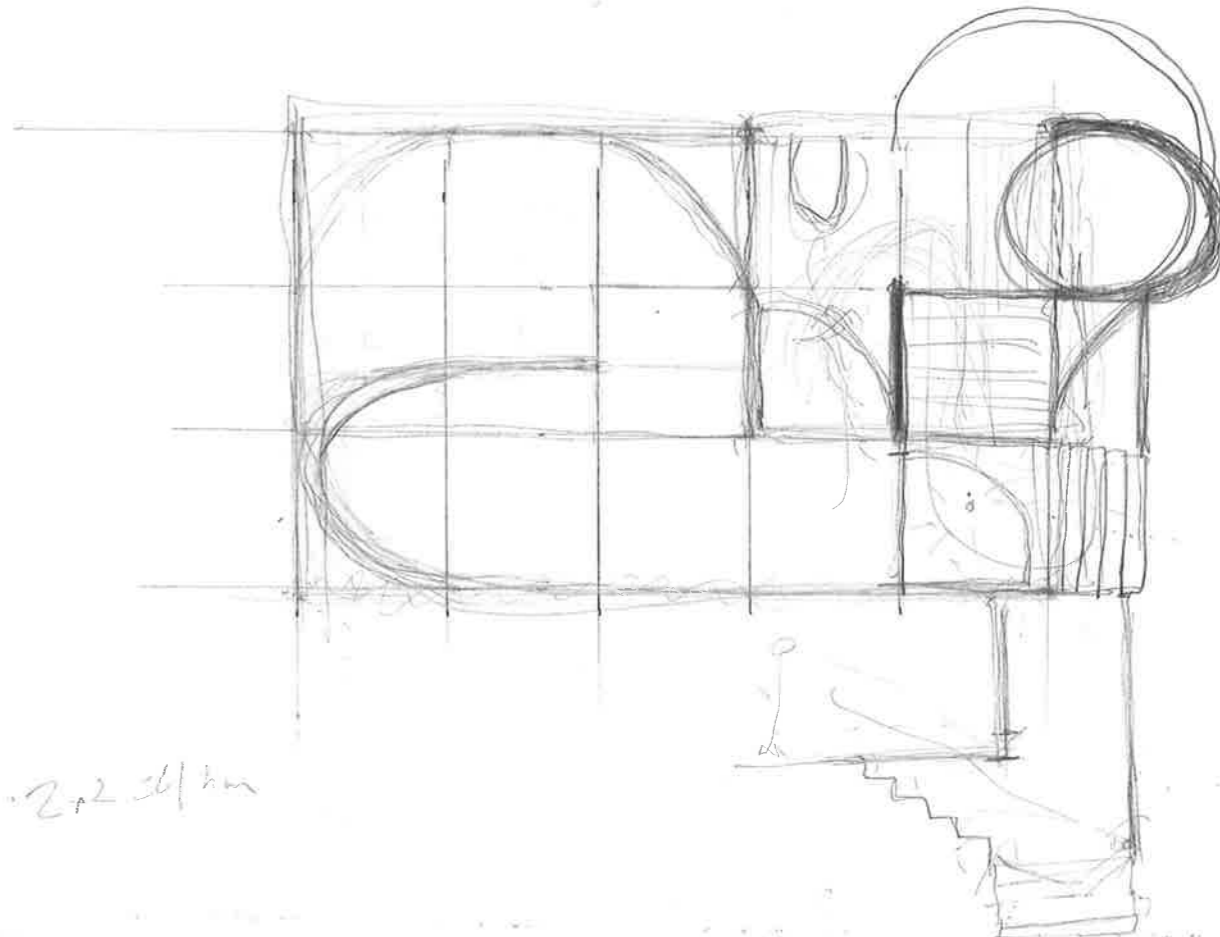
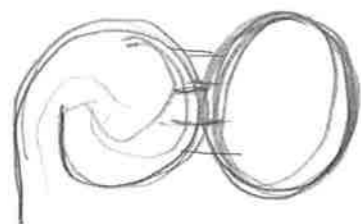
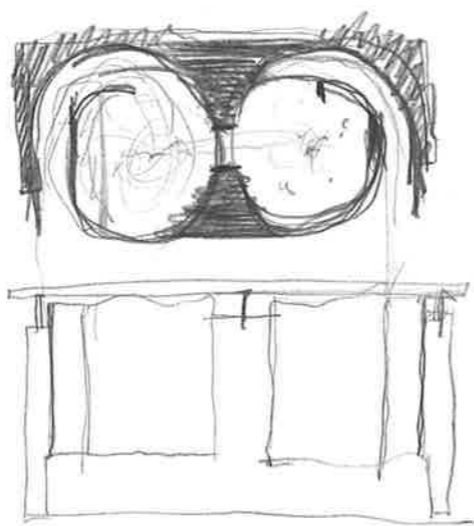
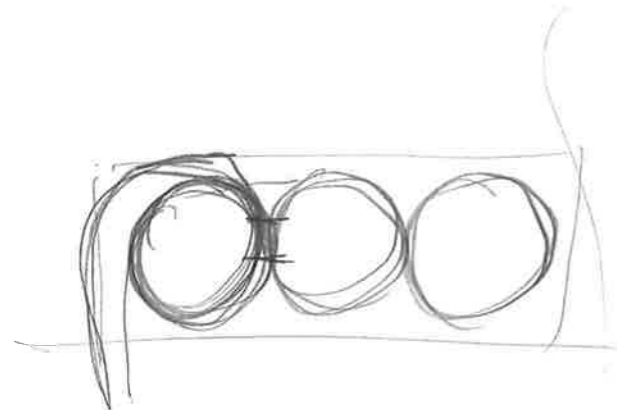
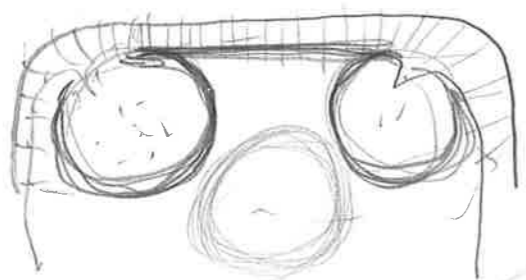
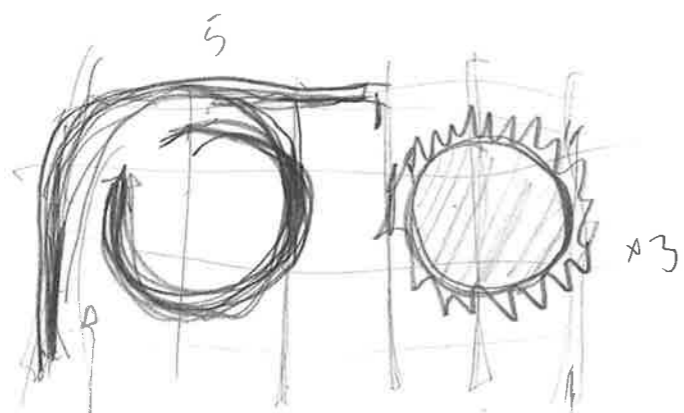

2+2 sl/hm

on valve analysis

to room Bab 1 u e / 12 meter

Bedroom  
+ surrounding area  
with the

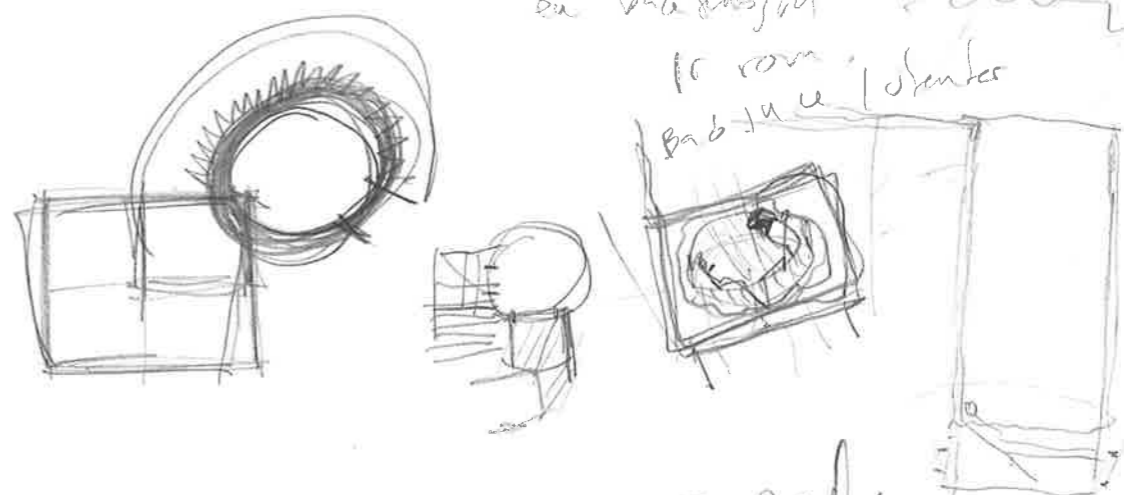

Took to road. separate



3x0

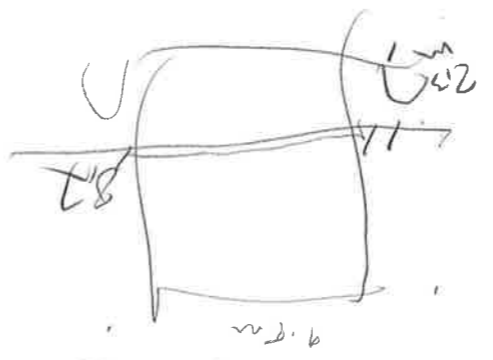
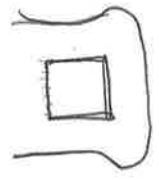

first



L-15 opp

SPH.

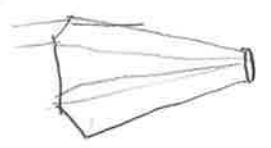

L-15 H side



was seen

L-15 with

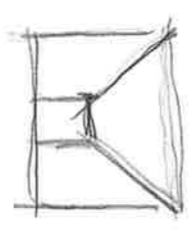
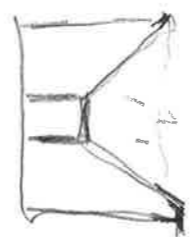
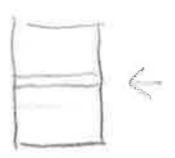

lincholate Bed + Sovereign / slane  
VASH

So = minus 4x4.

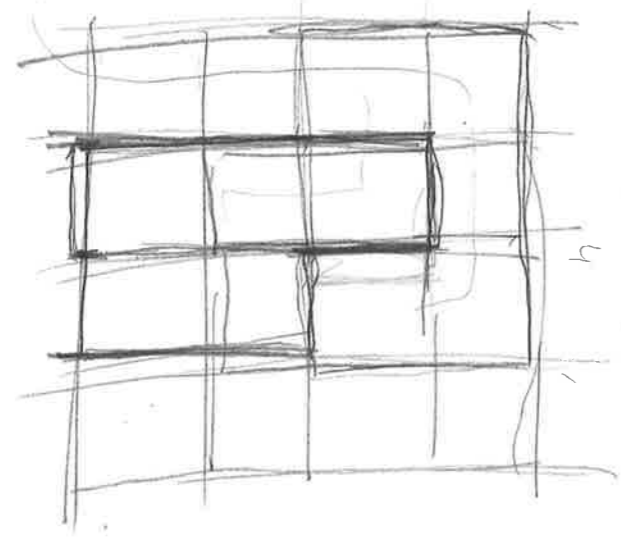
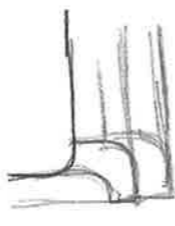
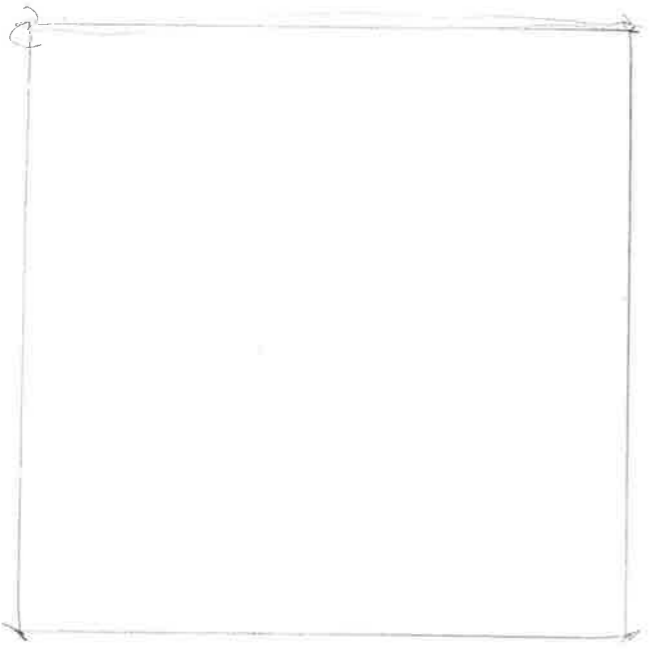

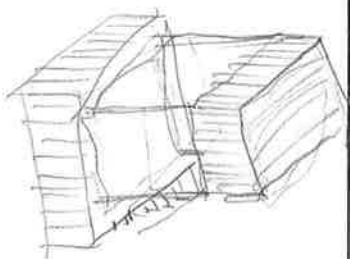

TH 7  
Glas + Plastik

son

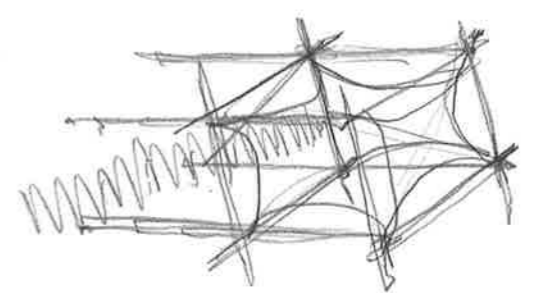

← tre  
← k12.1.

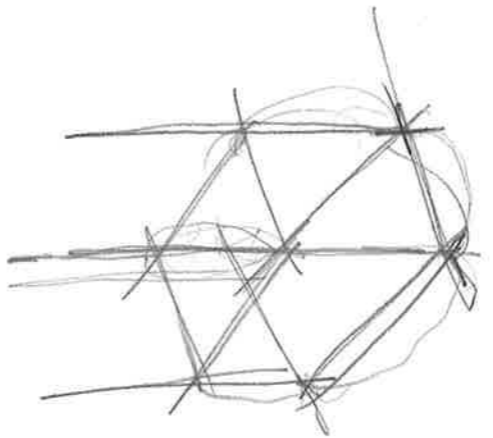

← tre  
← hollig.

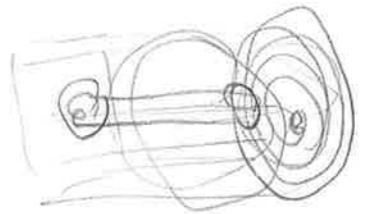

Row # 1



make outboard  
Material for son.  
open top.



← Frost

1 1 1 1  
2 1,5 2

5,5

LT5 should be:

- Hureber?

when or what was it.  
lys vi vare essensiel for os  
Utryknet.

- Hureber?

Domant inn i nalen til  
bli plestet son et objekt.  
Bette objekt vil gi en  
direkte innvisning pi Norden  
Domant med i utopians.

- Materialer: Hun glass type metryle skal undersøkes?

Heil.



Rohnde vger

Skil: Gerhand. se Hef?



Some et-vee Skil.

Bakery kussere

Glass: Rødt, 1/2a bodd.

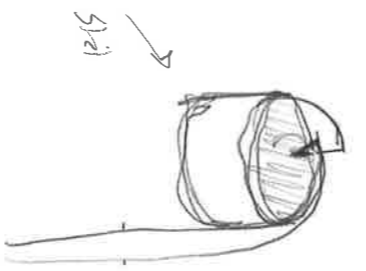

Skil

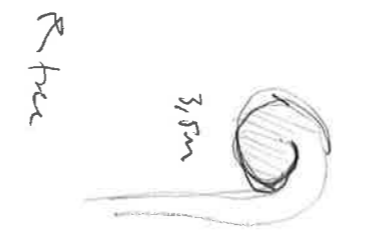

3,5m

R tre

Vann, bakkvop

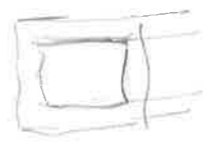

Frostylise

1kg

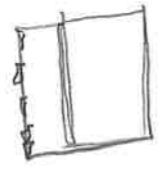

Ja, skal lage et rom

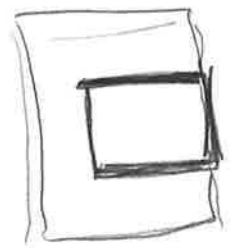

1000mm?



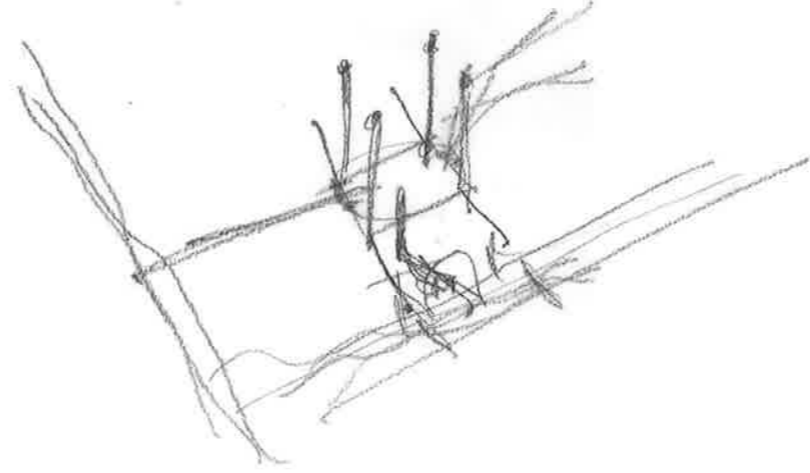

Blir pump get opp et annet skid

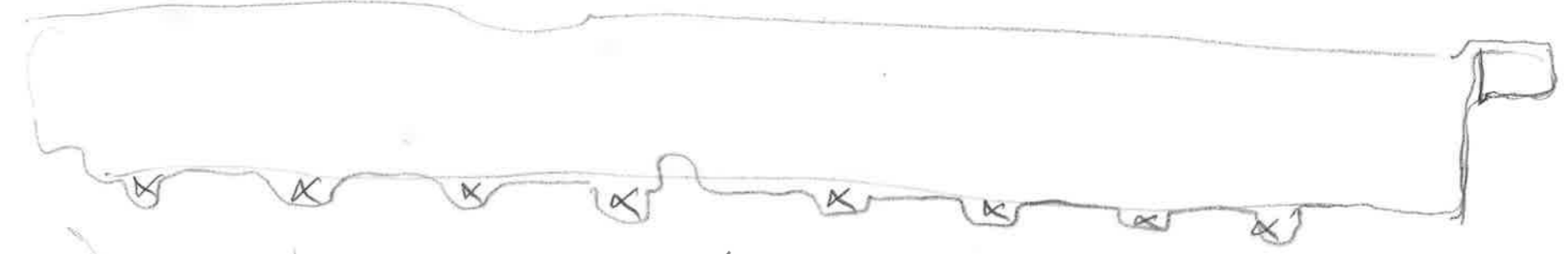

8 skid venner

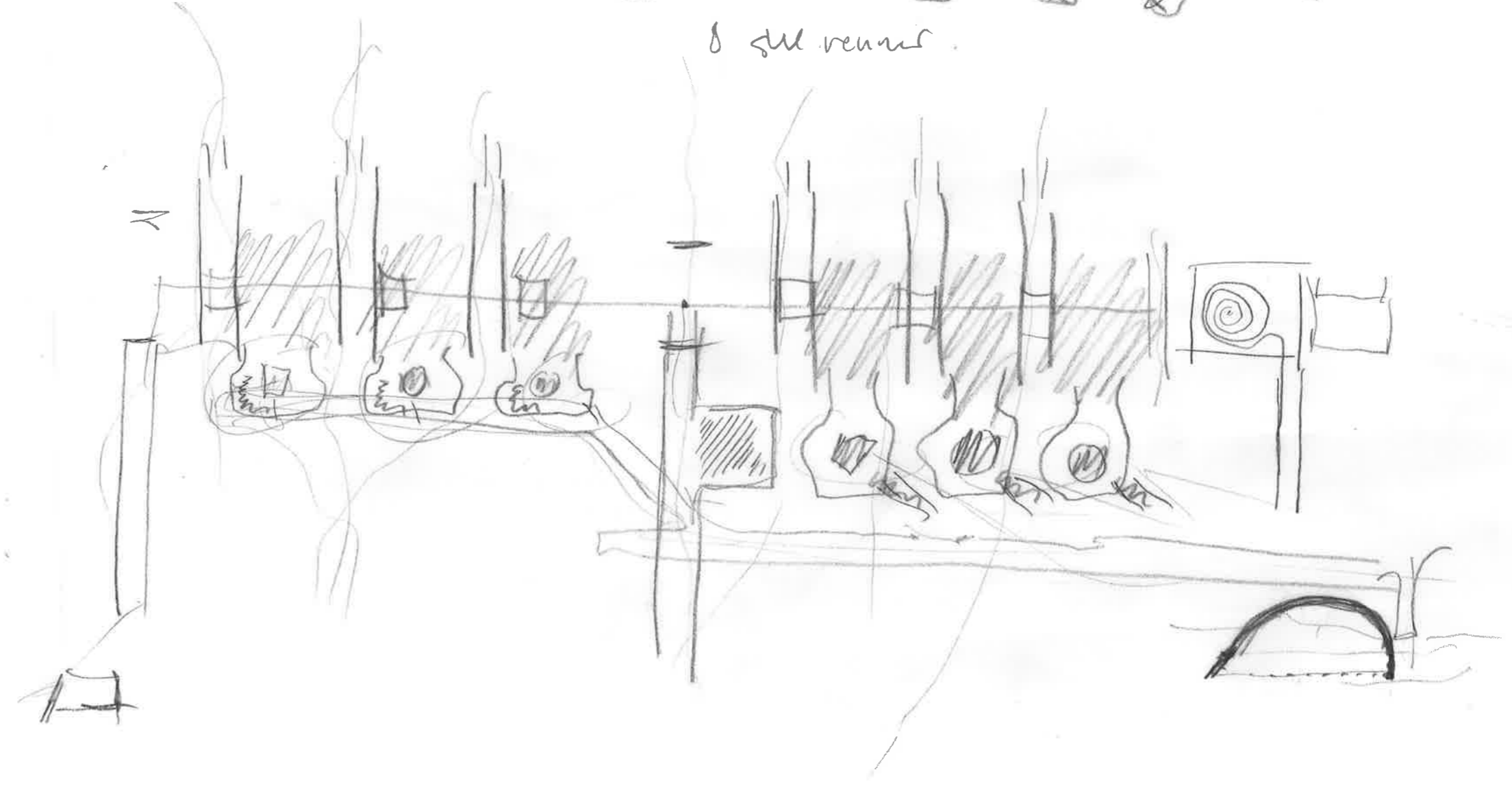

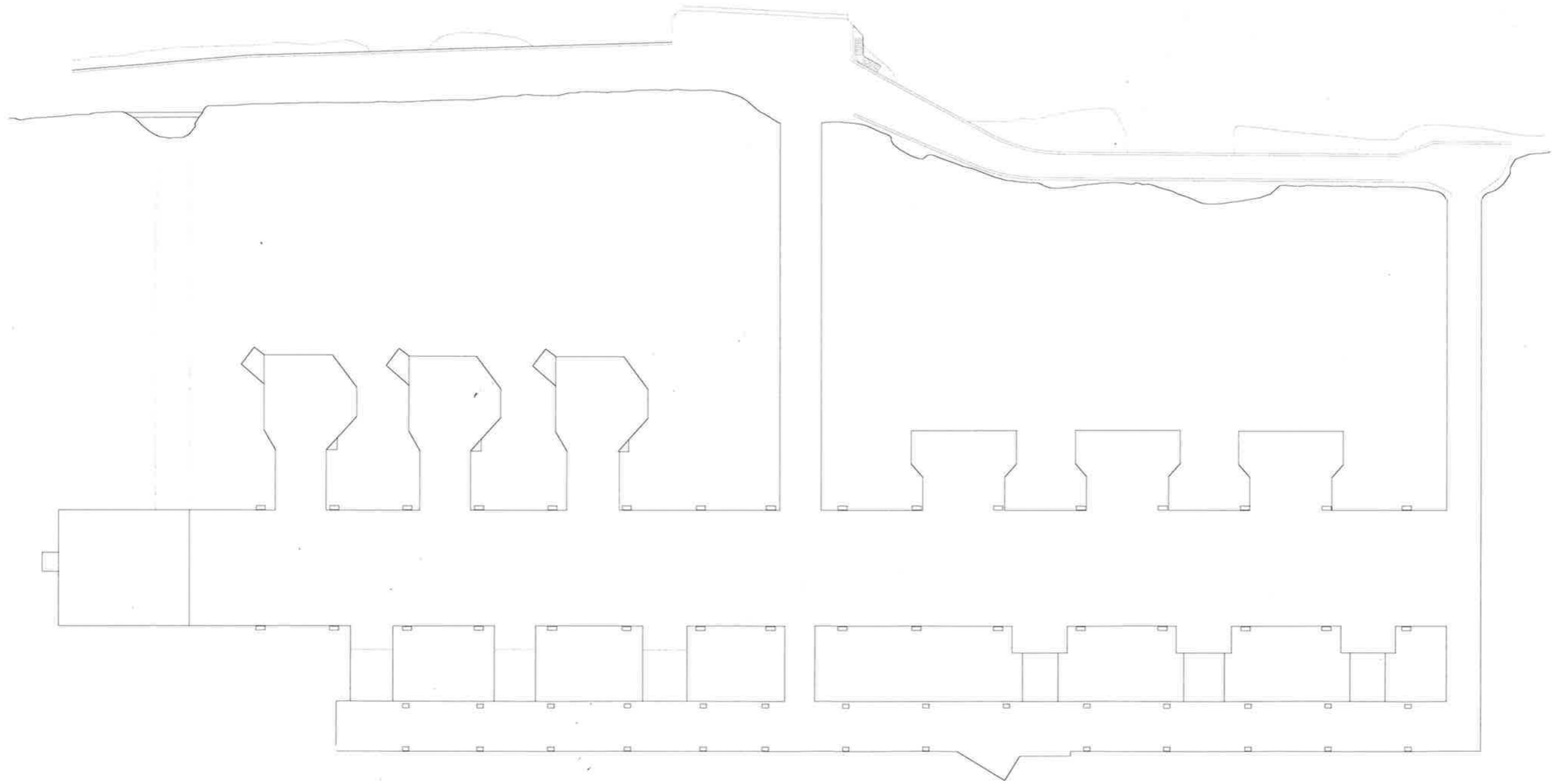

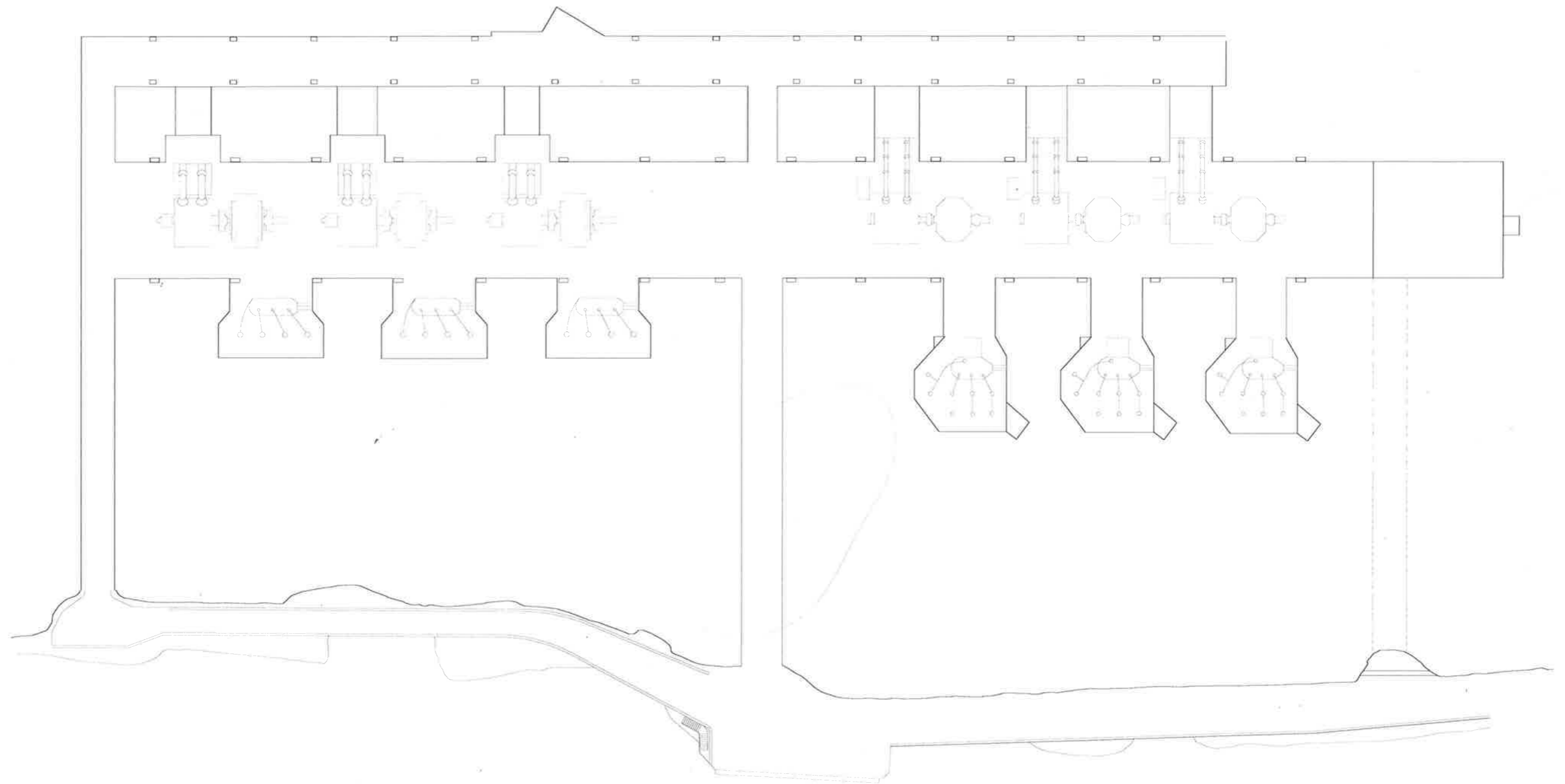

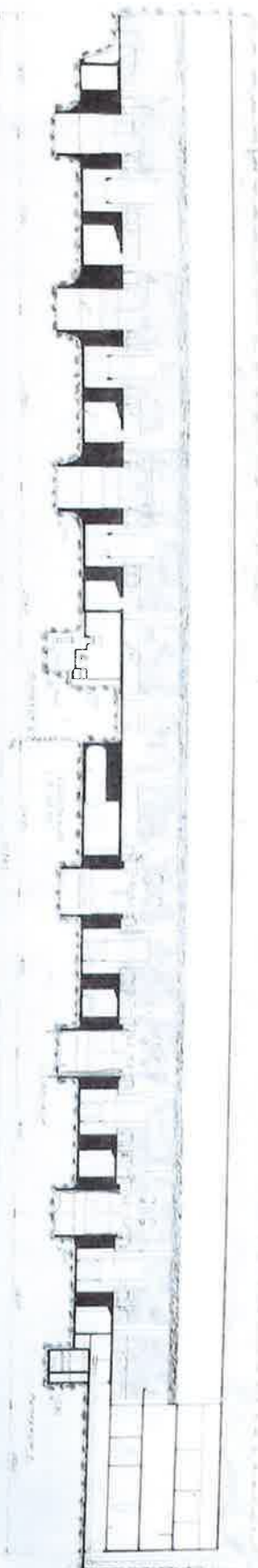

145

*Handwritten:* Krasavitskiy  
Tsvetlitskiy

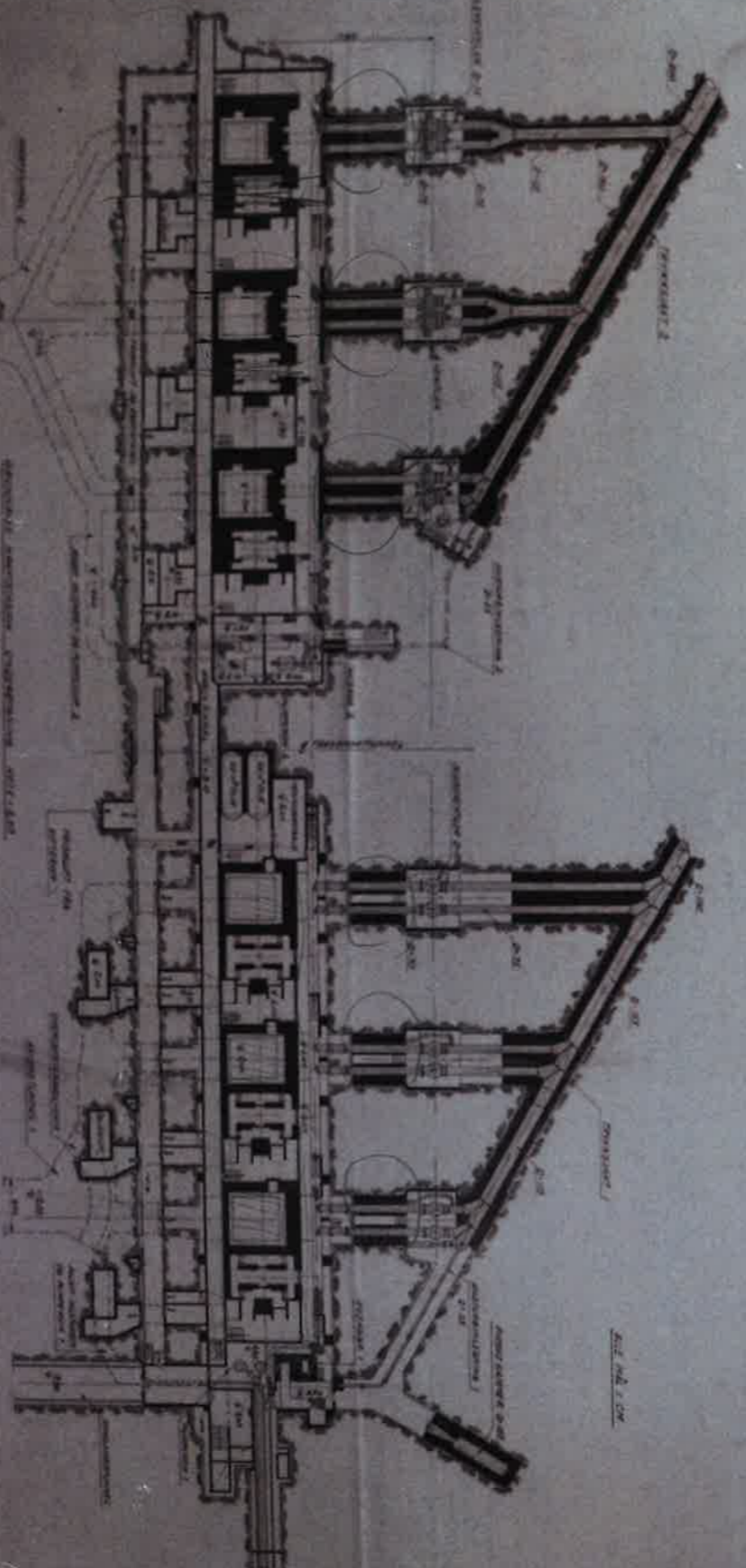
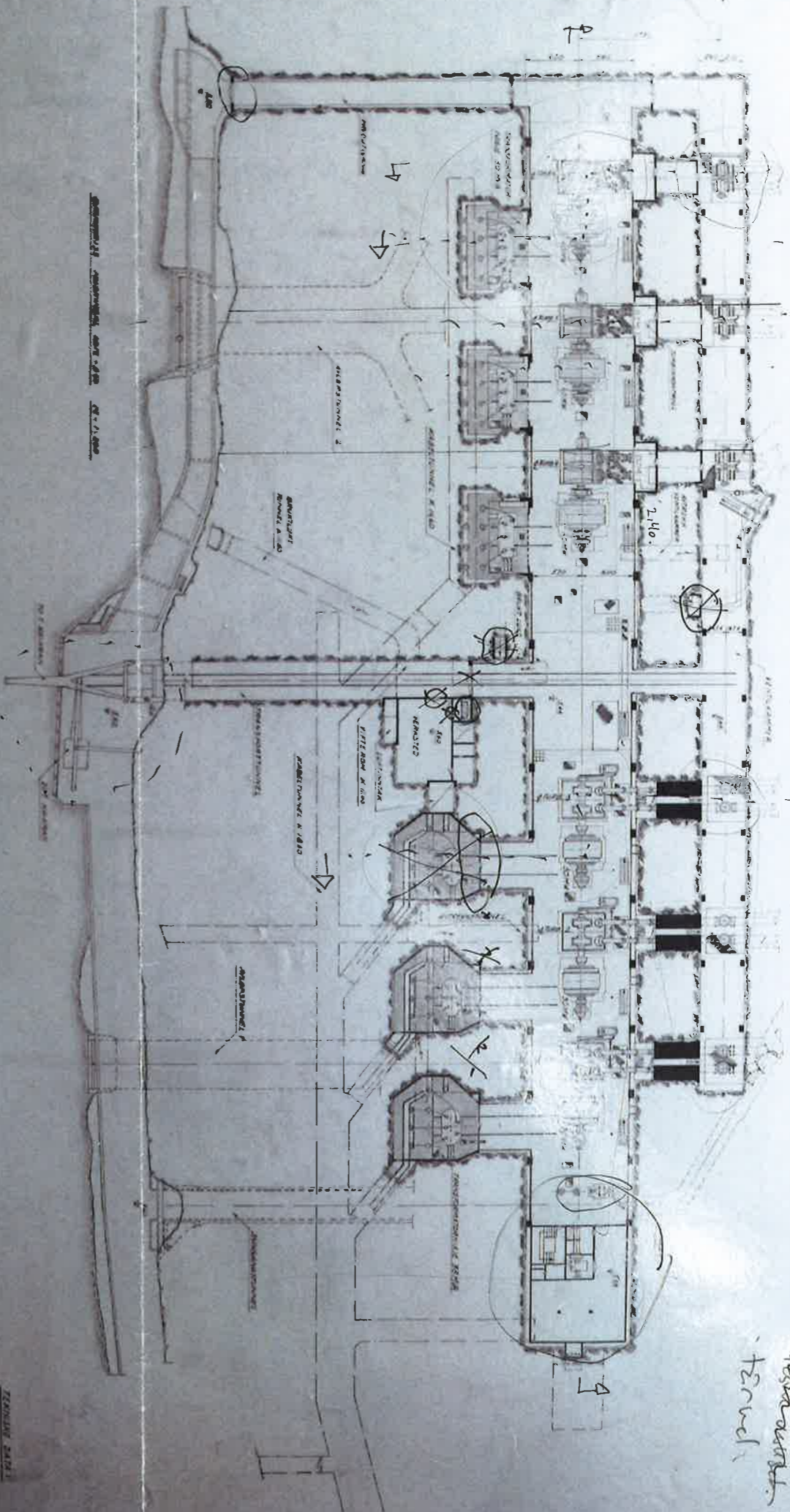

**ТЕХНИЧЕСКАЯ ЗАДАЧА**  
 Здание 1-2-3. КРАСОВИЦКИЙ  
 1-1-12000 м<sup>2</sup>  
 2-1-12000 м<sup>2</sup>  
 3-1-12000 м<sup>2</sup>  
 4-1-12000 м<sup>2</sup>  
 5-1-12000 м<sup>2</sup>  
 6-1-12000 м<sup>2</sup>  
 7-1-12000 м<sup>2</sup>  
 8-1-12000 м<sup>2</sup>  
 9-1-12000 м<sup>2</sup>  
 10-1-12000 м<sup>2</sup>  
 11-1-12000 м<sup>2</sup>  
 12-1-12000 м<sup>2</sup>  
 13-1-12000 м<sup>2</sup>  
 14-1-12000 м<sup>2</sup>  
 15-1-12000 м<sup>2</sup>  
 16-1-12000 м<sup>2</sup>  
 17-1-12000 м<sup>2</sup>  
 18-1-12000 м<sup>2</sup>  
 19-1-12000 м<sup>2</sup>  
 20-1-12000 м<sup>2</sup>  
 21-1-12000 м<sup>2</sup>  
 22-1-12000 м<sup>2</sup>  
 23-1-12000 м<sup>2</sup>  
 24-1-12000 м<sup>2</sup>  
 25-1-12000 м<sup>2</sup>  
 26-1-12000 м<sup>2</sup>  
 27-1-12000 м<sup>2</sup>  
 28-1-12000 м<sup>2</sup>  
 29-1-12000 м<sup>2</sup>  
 30-1-12000 м<sup>2</sup>  
 31-1-12000 м<sup>2</sup>  
 32-1-12000 м<sup>2</sup>  
 33-1-12000 м<sup>2</sup>  
 34-1-12000 м<sup>2</sup>  
 35-1-12000 м<sup>2</sup>  
 36-1-12000 м<sup>2</sup>  
 37-1-12000 м<sup>2</sup>  
 38-1-12000 м<sup>2</sup>  
 39-1-12000 м<sup>2</sup>  
 40-1-12000 м<sup>2</sup>  
 41-1-12000 м<sup>2</sup>  
 42-1-12000 м<sup>2</sup>  
 43-1-12000 м<sup>2</sup>  
 44-1-12000 м<sup>2</sup>  
 45-1-12000 м<sup>2</sup>  
 46-1-12000 м<sup>2</sup>  
 47-1-12000 м<sup>2</sup>  
 48-1-12000 м<sup>2</sup>  
 49-1-12000 м<sup>2</sup>  
 50-1-12000 м<sup>2</sup>  
 51-1-12000 м<sup>2</sup>  
 52-1-12000 м<sup>2</sup>  
 53-1-12000 м<sup>2</sup>  
 54-1-12000 м<sup>2</sup>  
 55-1-12000 м<sup>2</sup>  
 56-1-12000 м<sup>2</sup>  
 57-1-12000 м<sup>2</sup>  
 58-1-12000 м<sup>2</sup>  
 59-1-12000 м<sup>2</sup>  
 60-1-12000 м<sup>2</sup>  
 61-1-12000 м<sup>2</sup>  
 62-1-12000 м<sup>2</sup>  
 63-1-12000 м<sup>2</sup>  
 64-1-12000 м<sup>2</sup>  
 65-1-12000 м<sup>2</sup>  
 66-1-12000 м<sup>2</sup>  
 67-1-12000 м<sup>2</sup>  
 68-1-12000 м<sup>2</sup>  
 69-1-12000 м<sup>2</sup>  
 70-1-12000 м<sup>2</sup>  
 71-1-12000 м<sup>2</sup>  
 72-1-12000 м<sup>2</sup>  
 73-1-12000 м<sup>2</sup>  
 74-1-12000 м<sup>2</sup>  
 75-1-12000 м<sup>2</sup>  
 76-1-12000 м<sup>2</sup>  
 77-1-12000 м<sup>2</sup>  
 78-1-12000 м<sup>2</sup>  
 79-1-12000 м<sup>2</sup>  
 80-1-12000 м<sup>2</sup>  
 81-1-12000 м<sup>2</sup>  
 82-1-12000 м<sup>2</sup>  
 83-1-12000 м<sup>2</sup>  
 84-1-12000 м<sup>2</sup>  
 85-1-12000 м<sup>2</sup>  
 86-1-12000 м<sup>2</sup>  
 87-1-12000 м<sup>2</sup>  
 88-1-12000 м<sup>2</sup>  
 89-1-12000 м<sup>2</sup>  
 90-1-12000 м<sup>2</sup>  
 91-1-12000 м<sup>2</sup>  
 92-1-12000 м<sup>2</sup>  
 93-1-12000 м<sup>2</sup>  
 94-1-12000 м<sup>2</sup>  
 95-1-12000 м<sup>2</sup>  
 96-1-12000 м<sup>2</sup>  
 97-1-12000 м<sup>2</sup>  
 98-1-12000 м<sup>2</sup>  
 99-1-12000 м<sup>2</sup>  
 100-1-12000 м<sup>2</sup>





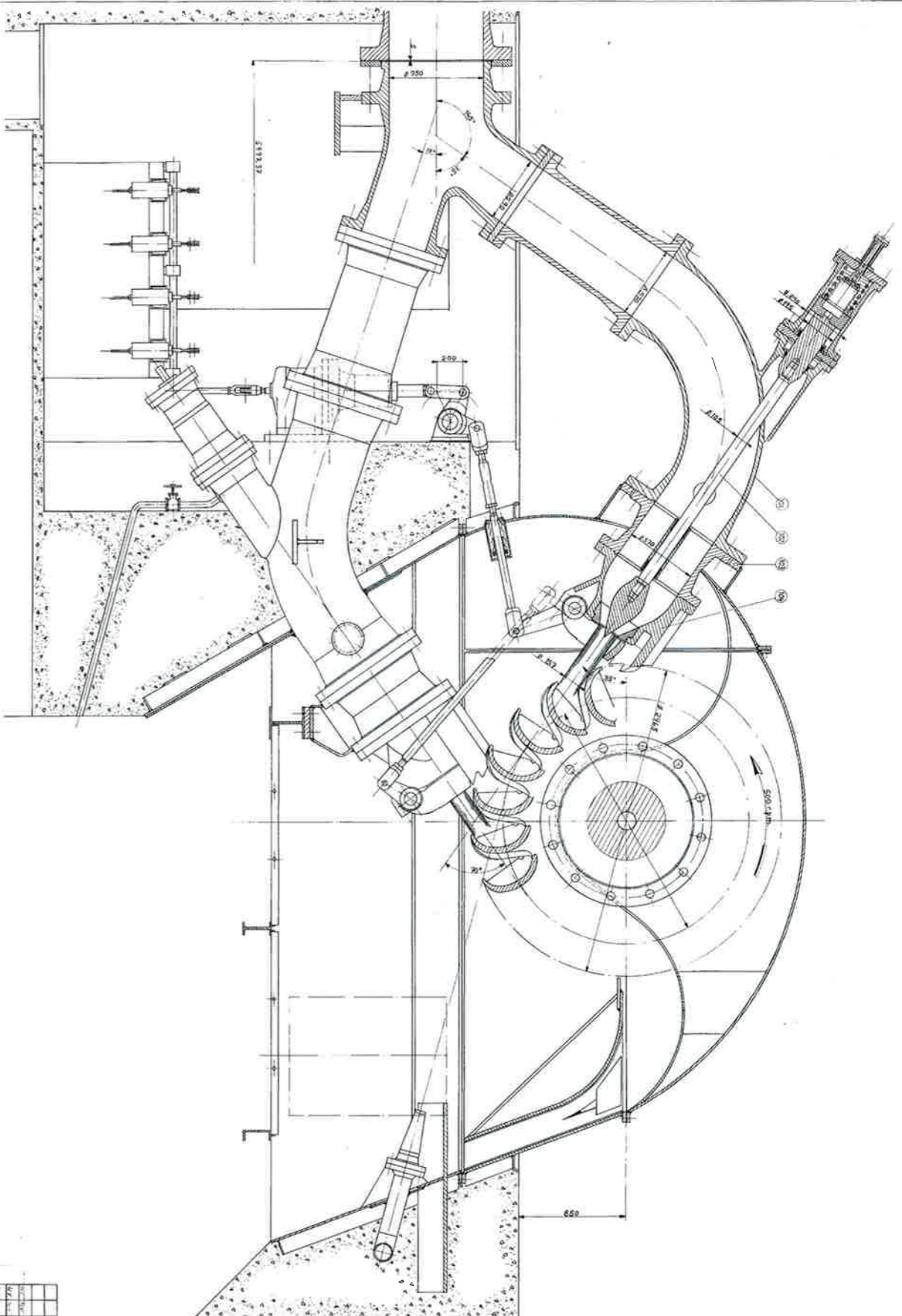

1	2	3	4	5	6	7	8	9	10	11	12	13	14	15	16	17	18	19	20	21	22	23	24	25	26	27	28	29	30	31	32	33	34	35	36	37	38	39	40	41	42	43	44	45	46	47	48	49	50	51	52	53	54	55	56	57	58	59	60	61	62	63	64	65	66	67	68	69	70	71	72	73	74	75	76	77	78	79	80	81	82	83	84	85	86	87	88	89	90	91	92	93	94	95	96	97	98	99	100
---	---	---	---	---	---	---	---	---	----	----	----	----	----	----	----	----	----	----	----	----	----	----	----	----	----	----	----	----	----	----	----	----	----	----	----	----	----	----	----	----	----	----	----	----	----	----	----	----	----	----	----	----	----	----	----	----	----	----	----	----	----	----	----	----	----	----	----	----	----	----	----	----	----	----	----	----	----	----	----	----	----	----	----	----	----	----	----	----	----	----	----	----	----	----	----	----	----	----	-----

22113-0  
 Dobbelt Rektion-Turbin.  
 Avtillarsstat. Ks410  
 Sammansättning

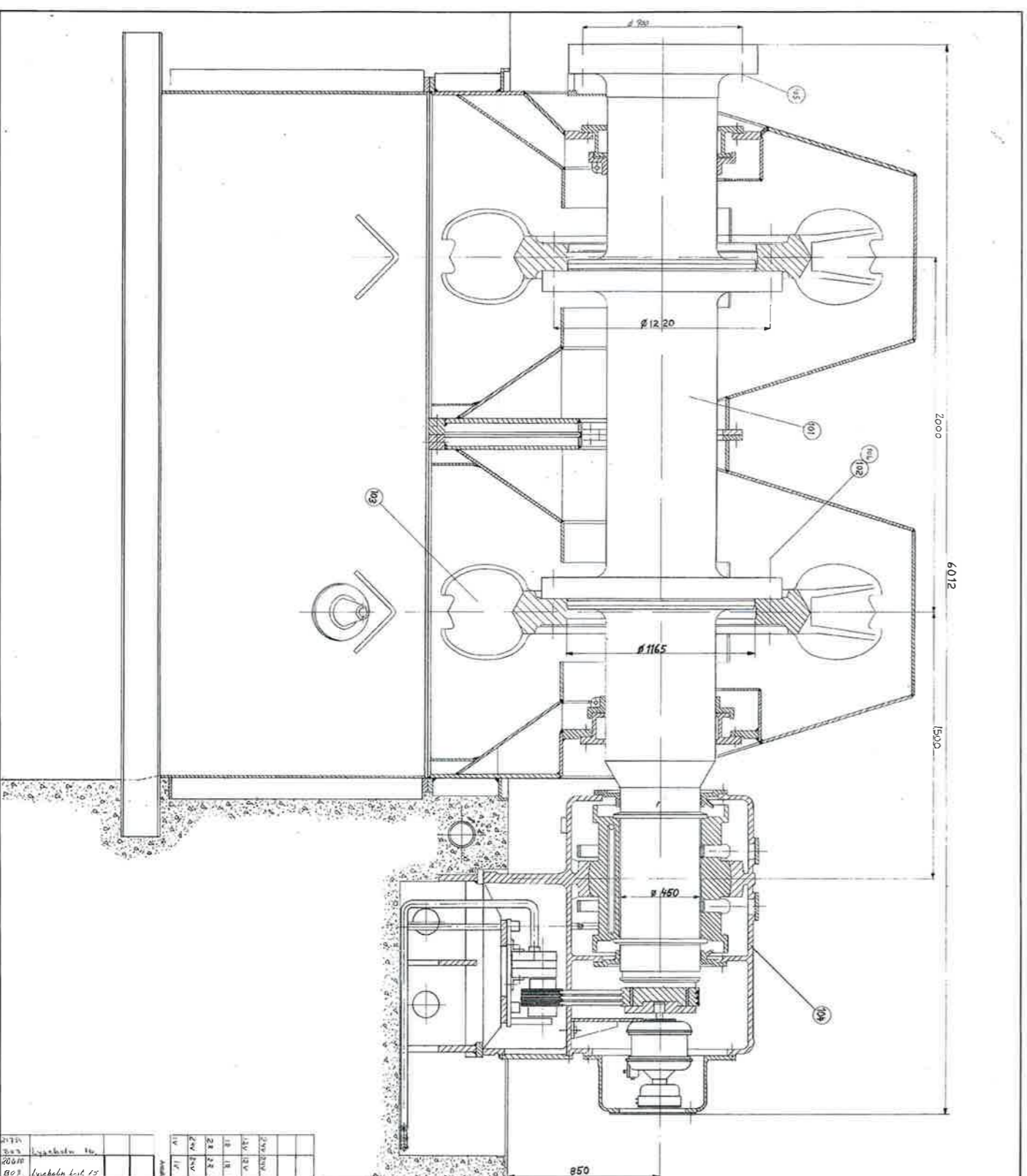

1	2	3	4	5	6	7	8	9	10	11	12	13	14	15	16	17	18	19	20	21	22	23	24	25	26	27	28	29	30	31	32	33	34	35	36	37	38	39	40	41	42	43	44	45	46	47	48	49	50	51	52	53	54	55	56	57	58	59	60	61	62	63	64	65	66	67	68	69	70	71	72	73	74	75	76	77	78	79	80	81	82	83	84	85	86	87	88	89	90	91	92	93	94	95	96	97	98	99	100
---	---	---	---	---	---	---	---	---	----	----	----	----	----	----	----	----	----	----	----	----	----	----	----	----	----	----	----	----	----	----	----	----	----	----	----	----	----	----	----	----	----	----	----	----	----	----	----	----	----	----	----	----	----	----	----	----	----	----	----	----	----	----	----	----	----	----	----	----	----	----	----	----	----	----	----	----	----	----	----	----	----	----	----	----	----	----	----	----	----	----	----	----	----	----	----	----	----	----	-----

22124-1  
 Dobbelt Rektion-Turbin.  
 P=4138, n=500, H=510  
 Sammansatt. räkenskaps delar

Tillhörig Lapschaktör-  
 Korte K 2 b 2 som

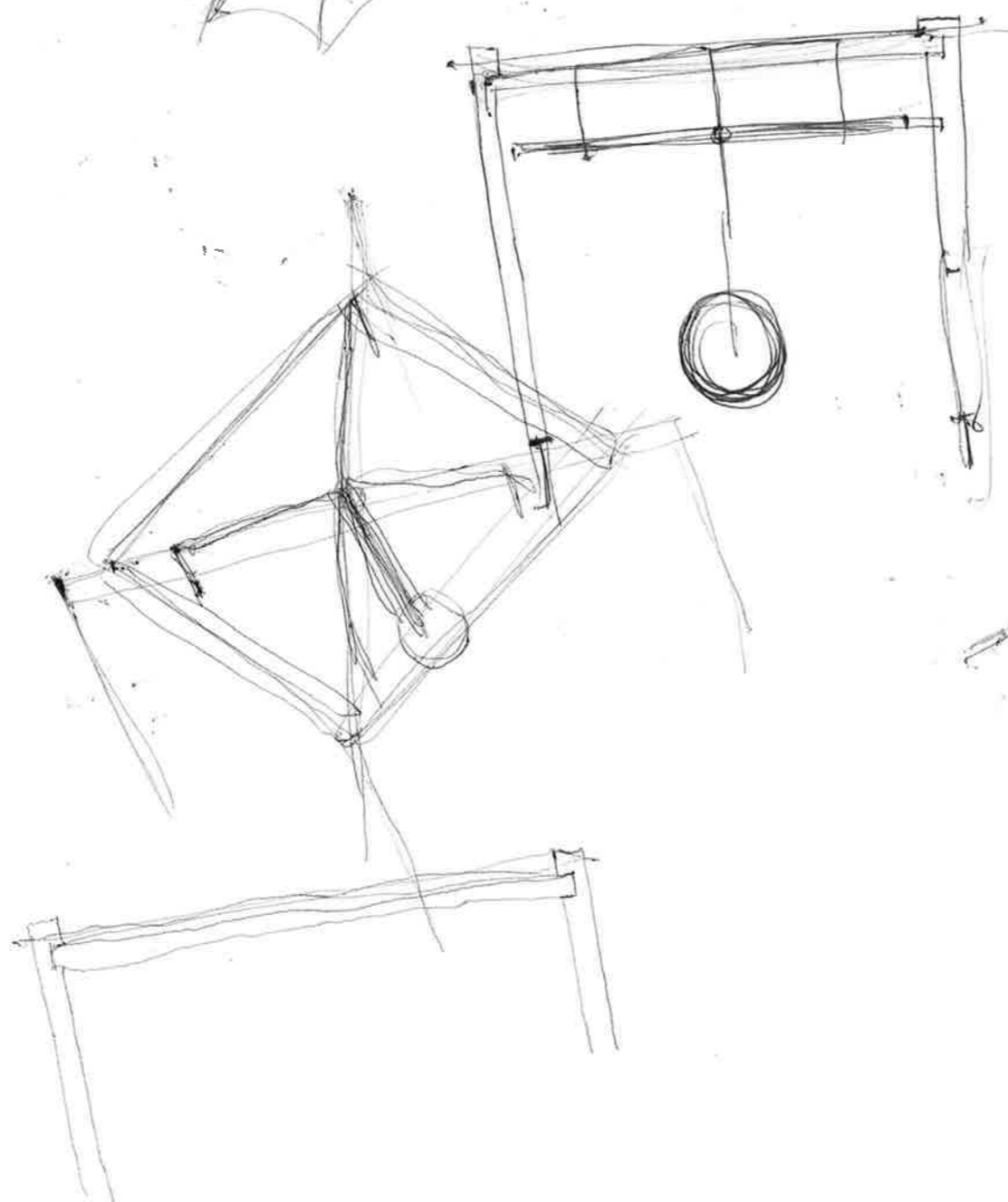
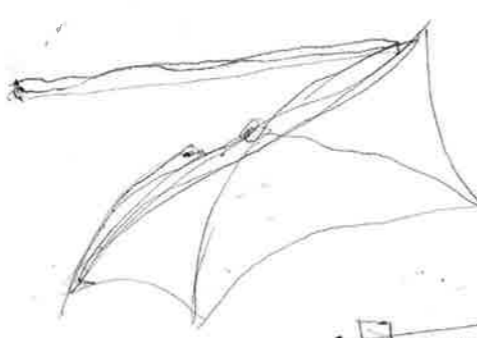
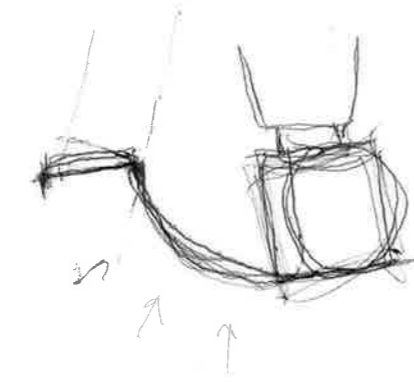
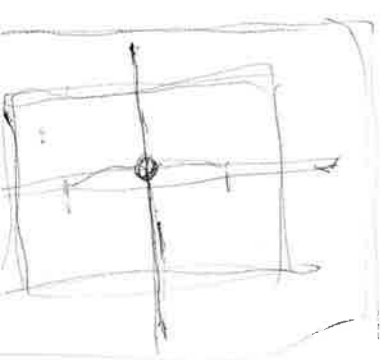
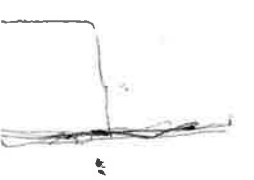
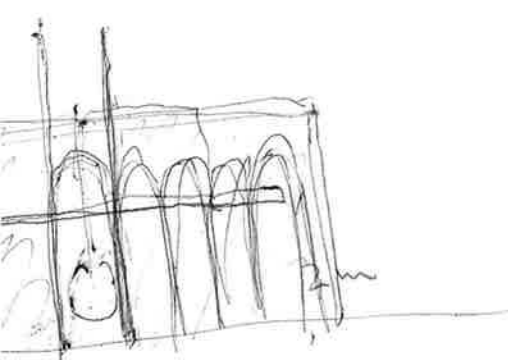

Föres objekt in  
a room.

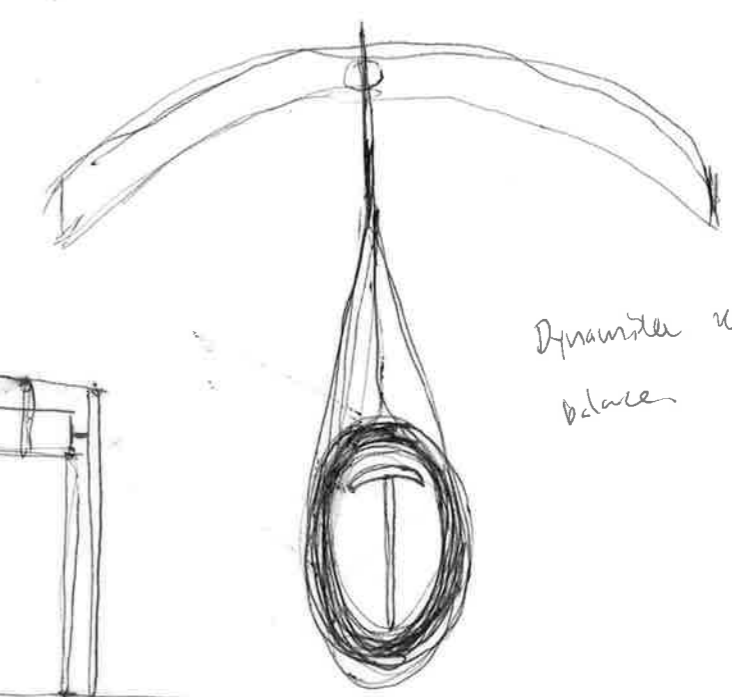
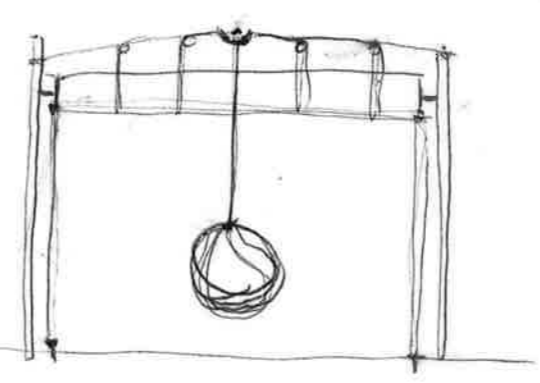

Dynamite kalle er:  
Delare

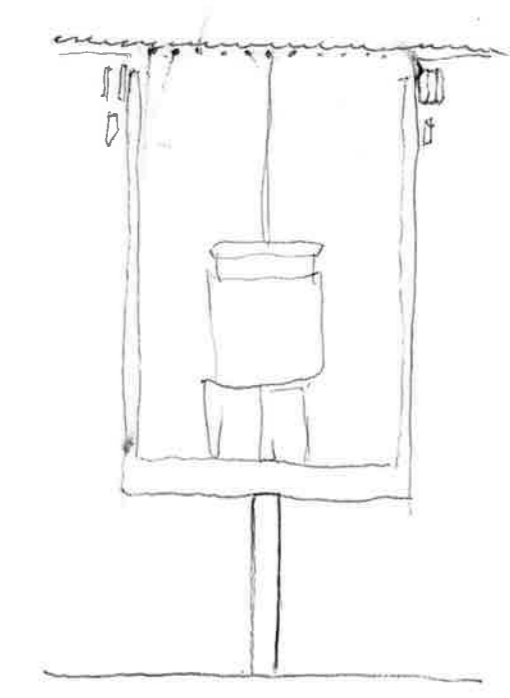
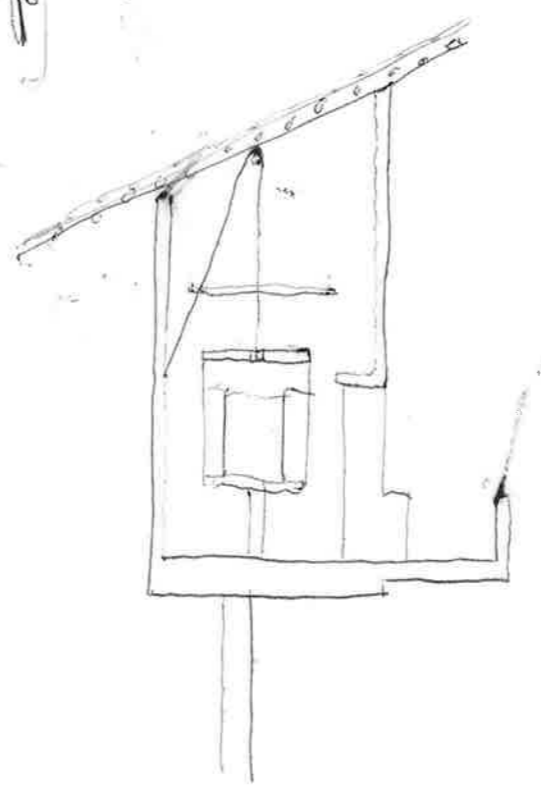

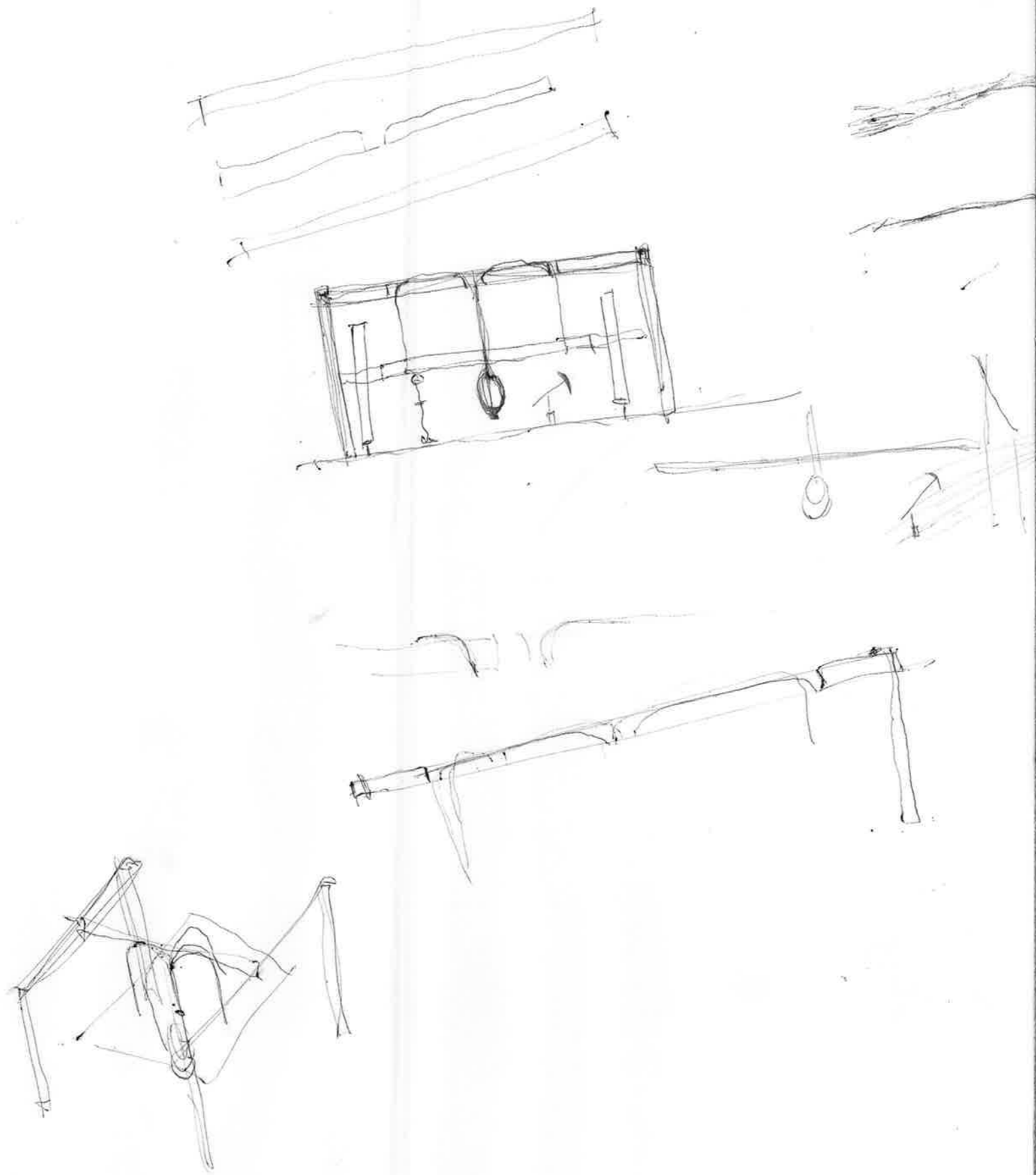

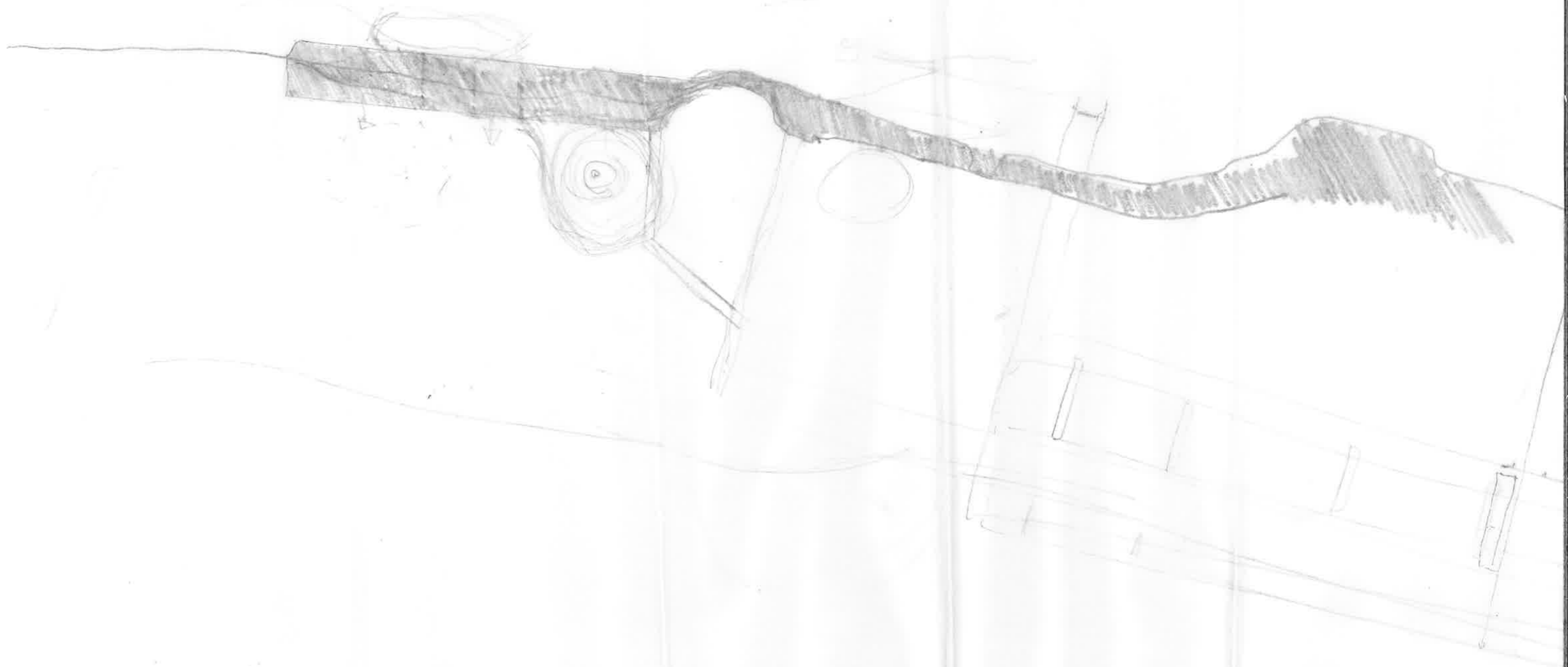

Handwritten notes in a non-English script, likely a technical or engineering language. The text is written in a cursive style and appears to be a list or set of instructions related to the drawing above. Some legible words include "Handwritten", "Technical", and "Notes".

Handwritten notes at the bottom left corner of the page, possibly providing additional context or a title for the drawing.

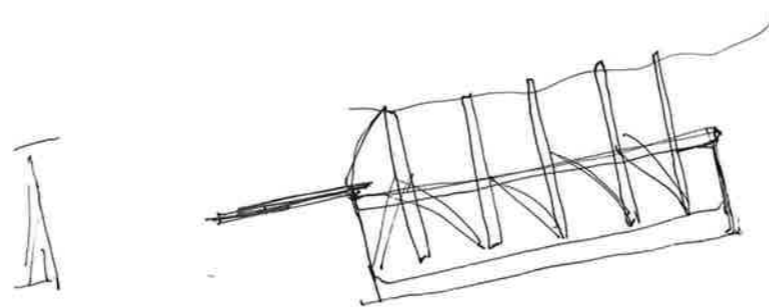
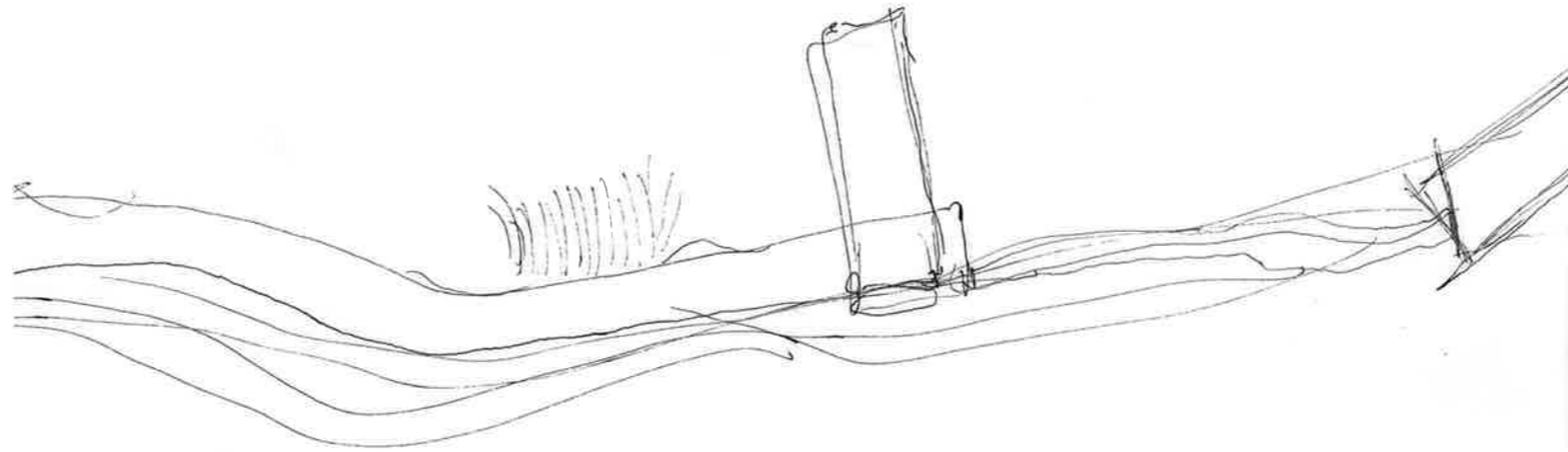
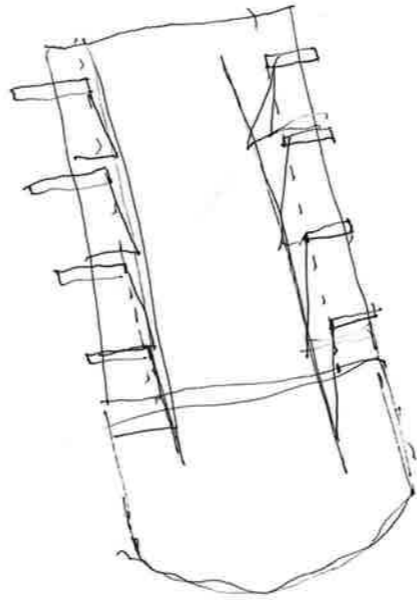
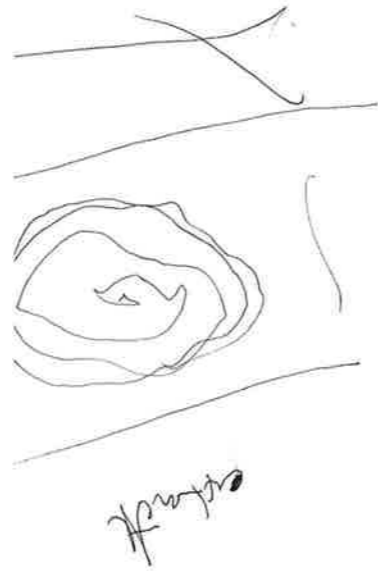

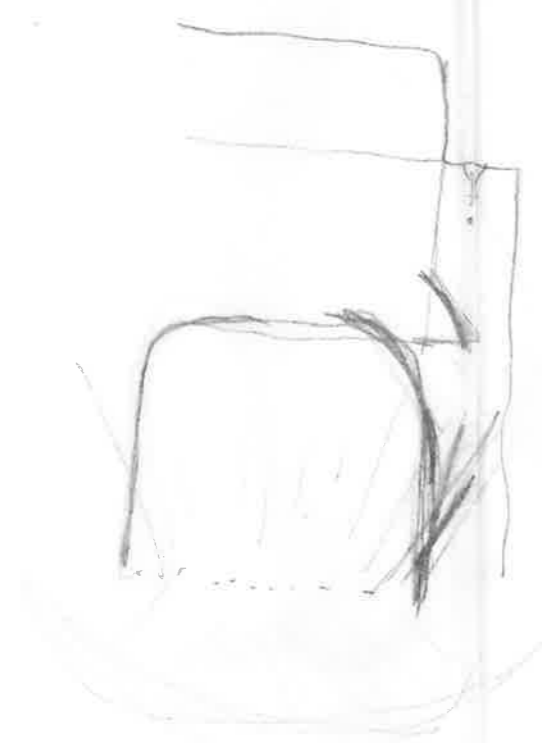

22 rows

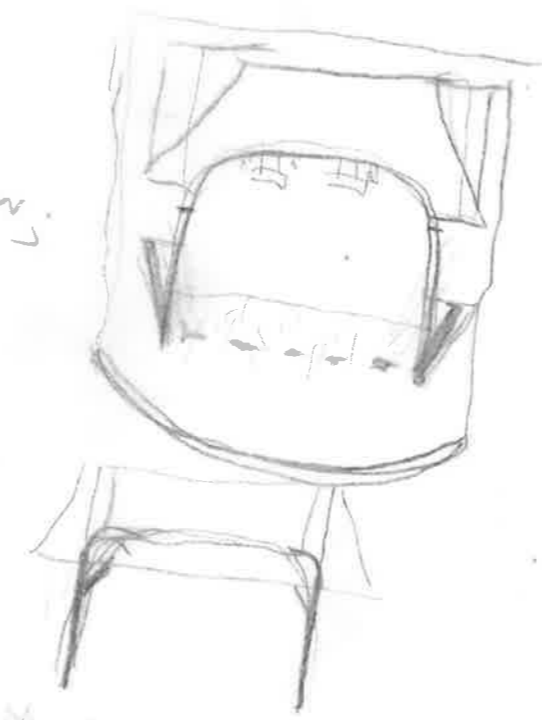

22 rows

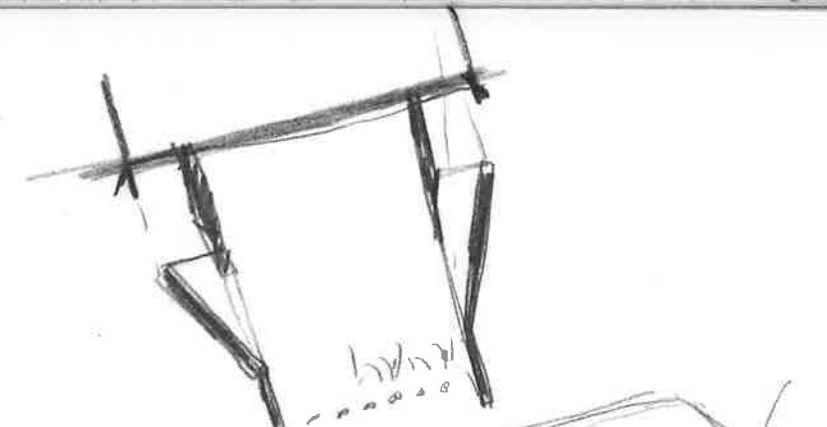

22 rows



22 rows

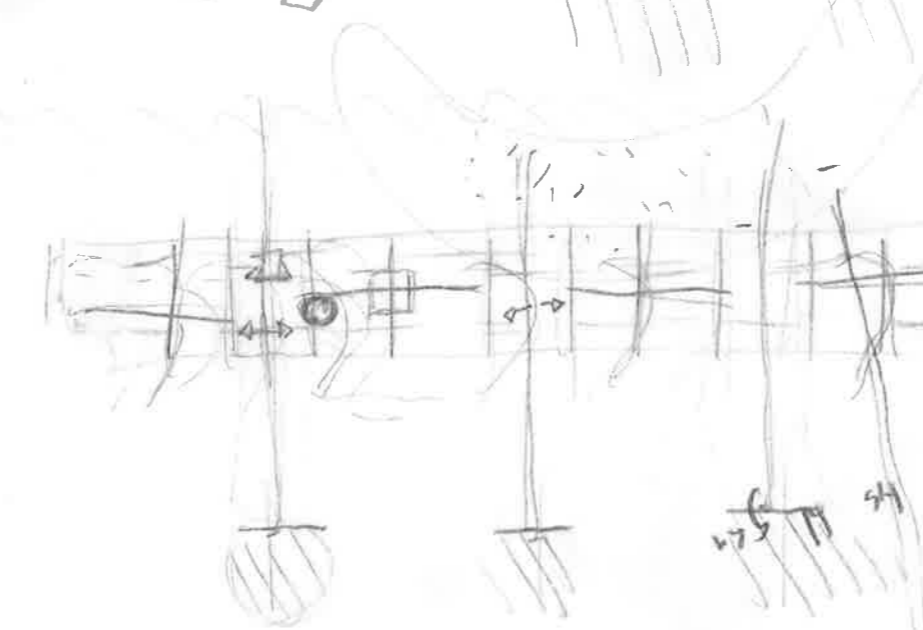

22 rows



22 rows

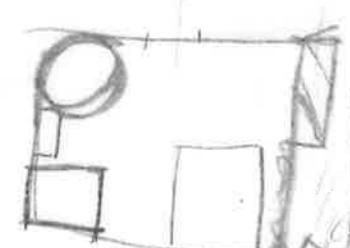
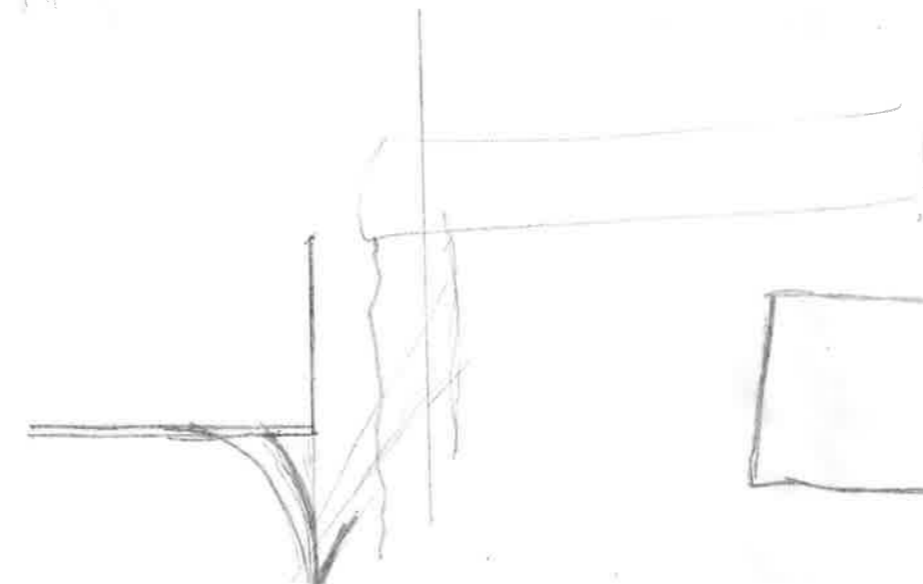

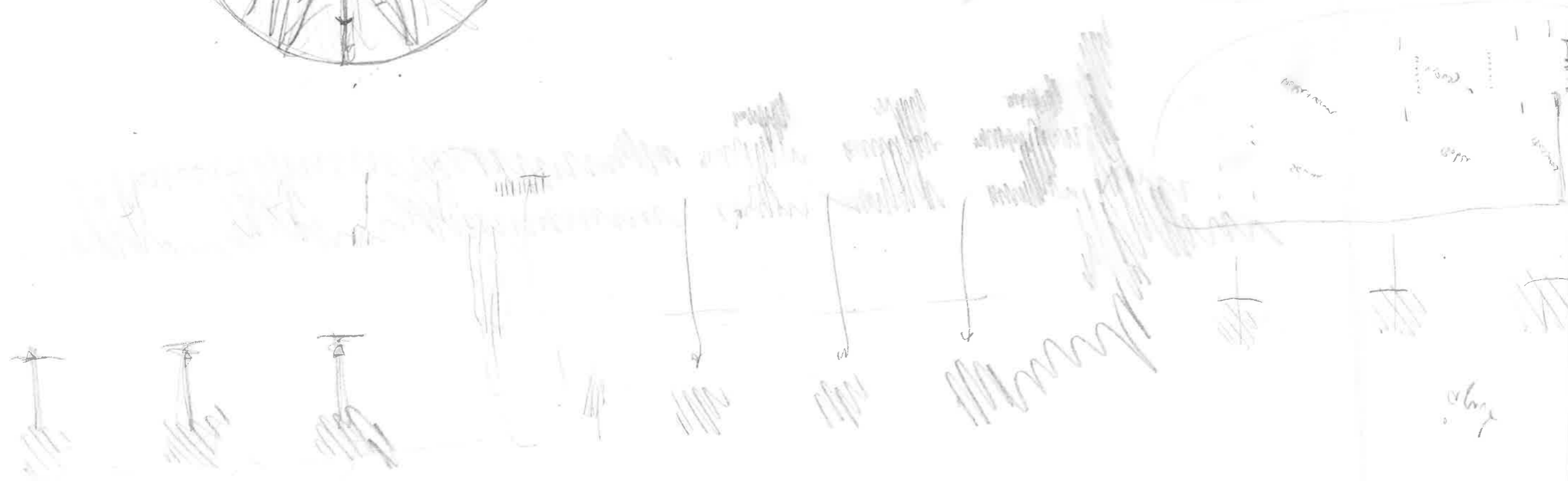
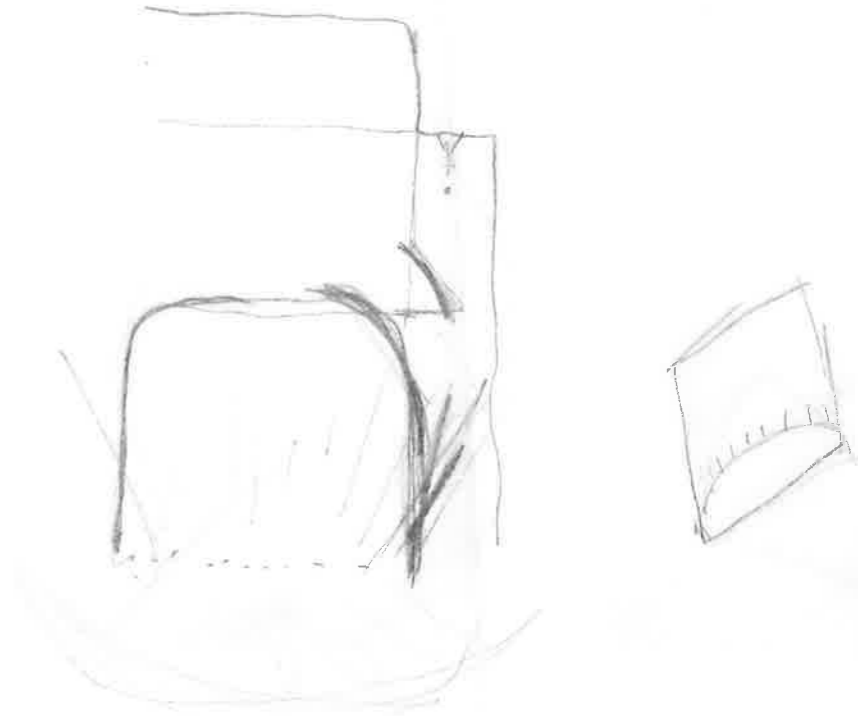
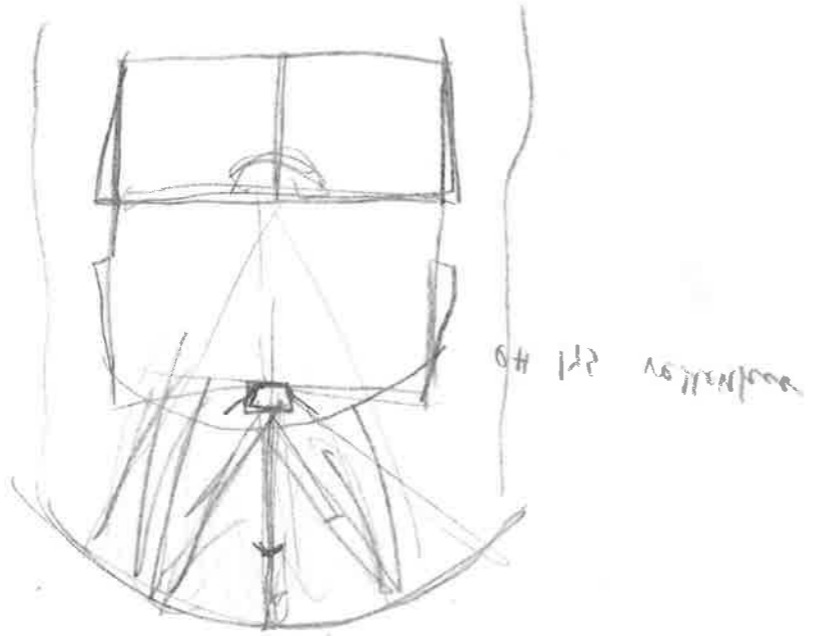

Handwritten notes or scribbles at the bottom center of the page.

Handwritten text "abge" located in the bottom right corner of the diagram area.



Handwritten notes at the top of the page, possibly describing the drawing or providing instructions.

Handwritten number '26' in the center of the page.

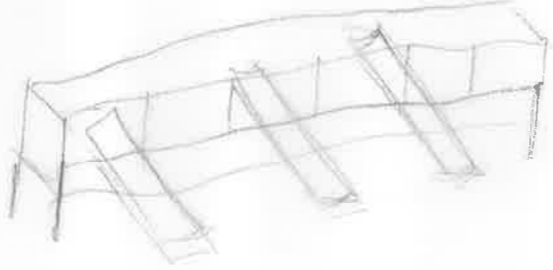
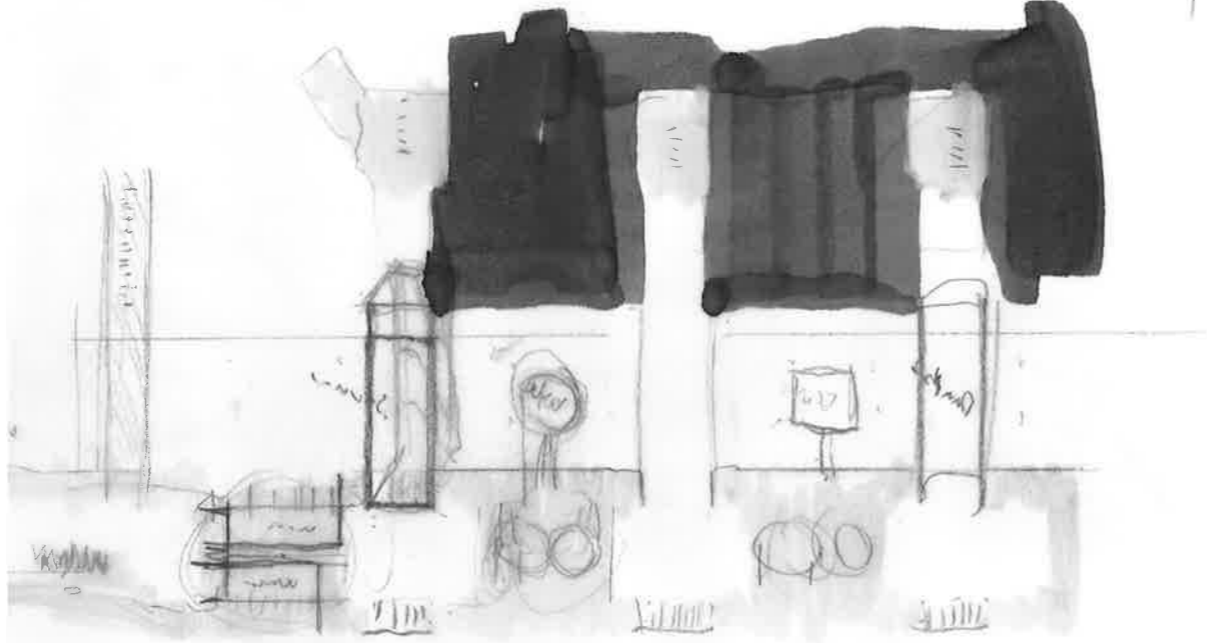

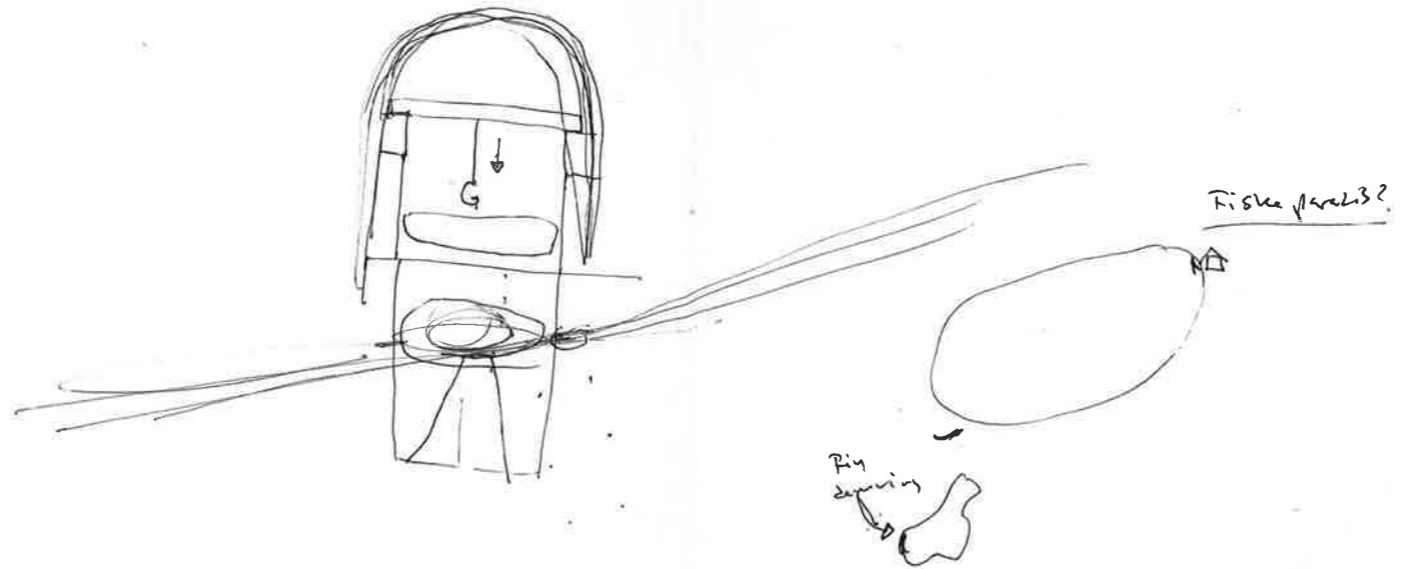

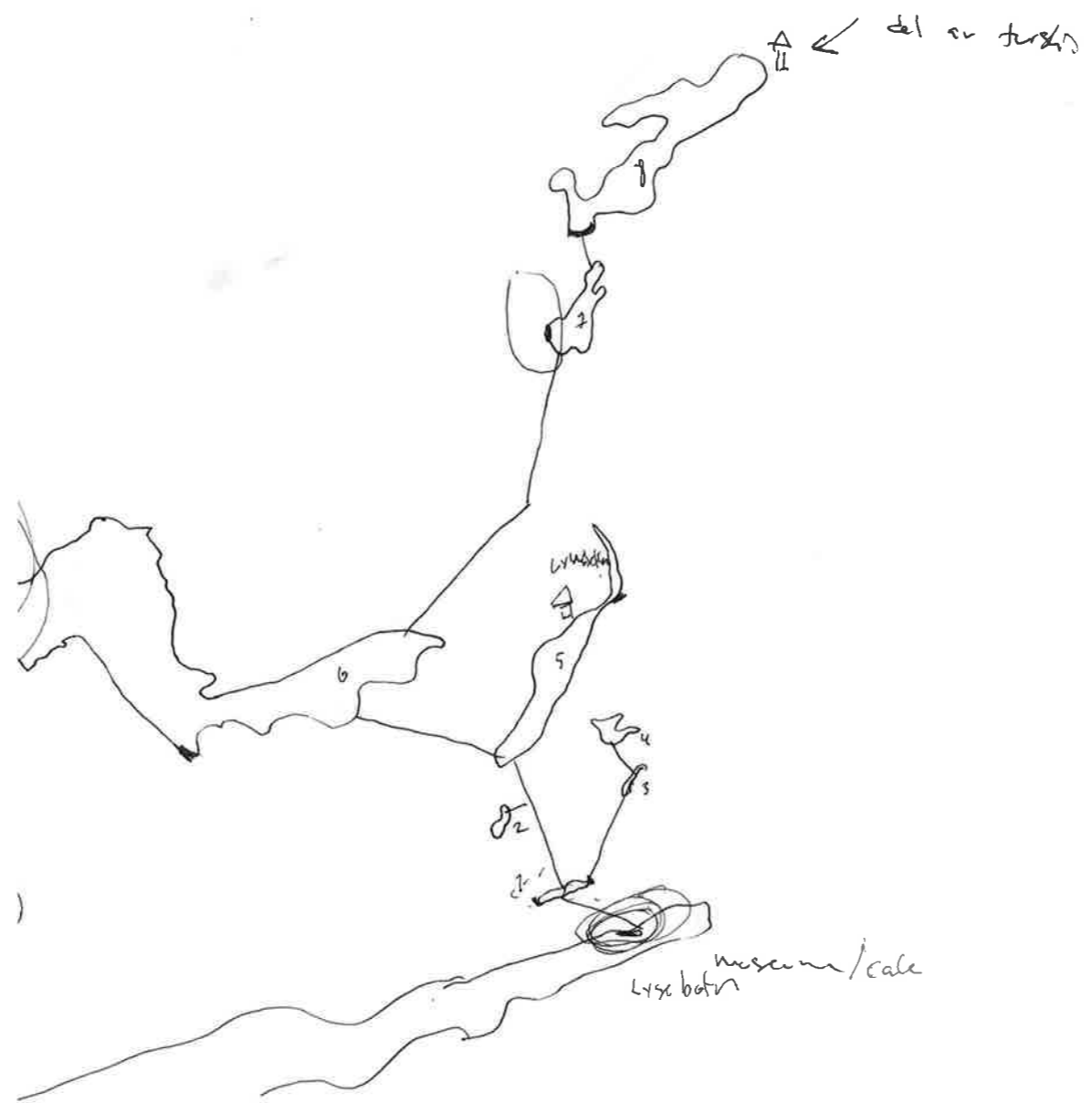

20.00  
Kowloon  
from M  
to 20.00

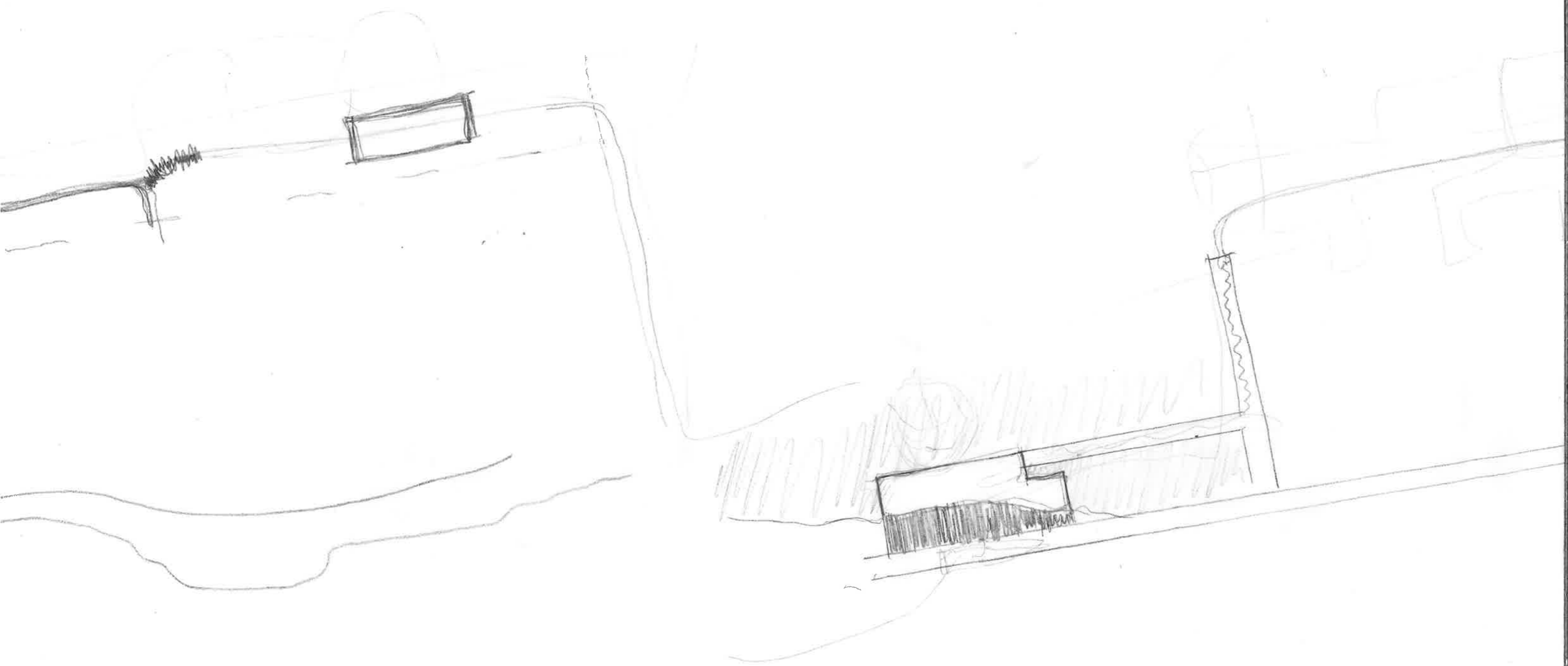

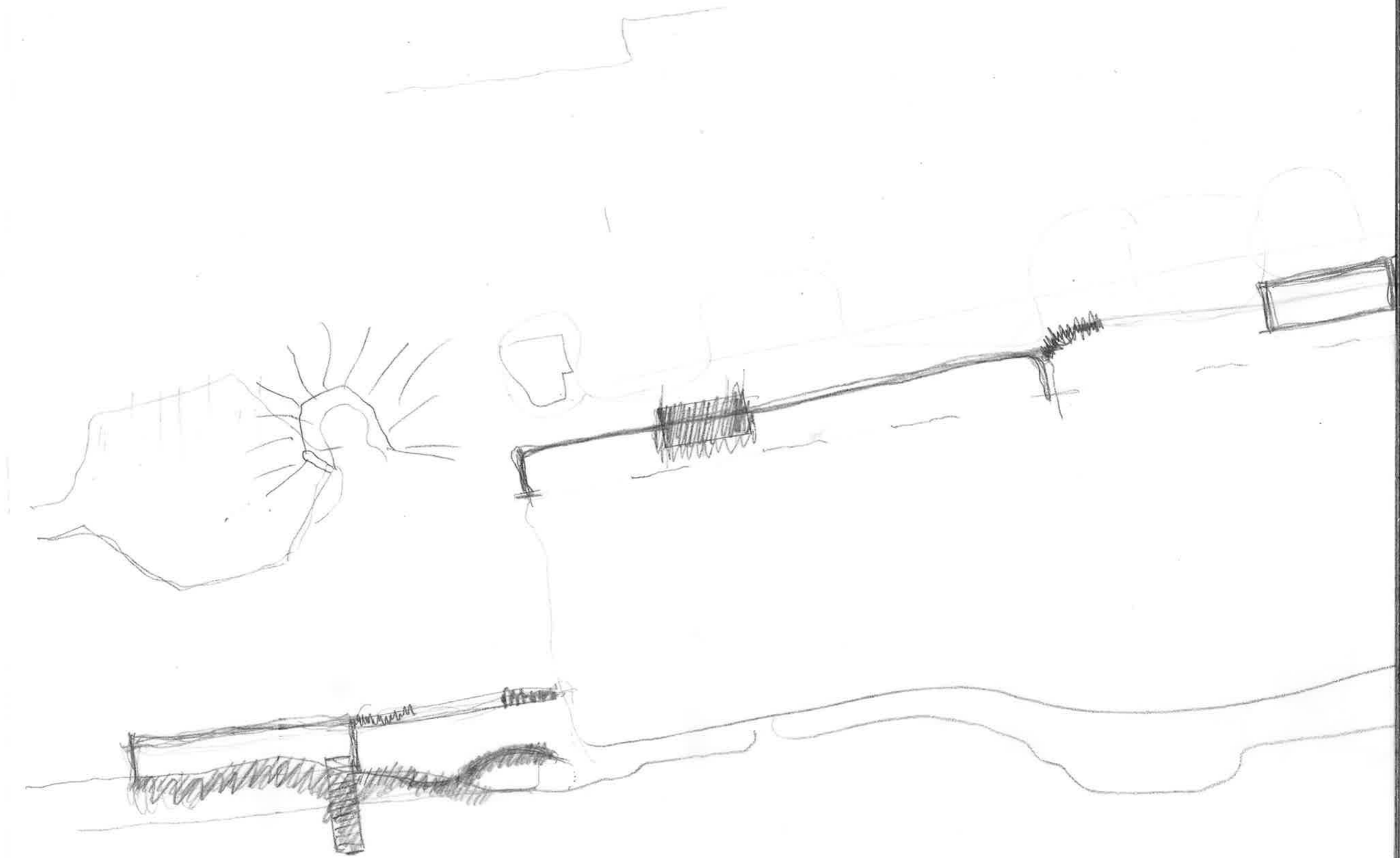

3

5

Hydrant

4

6

8

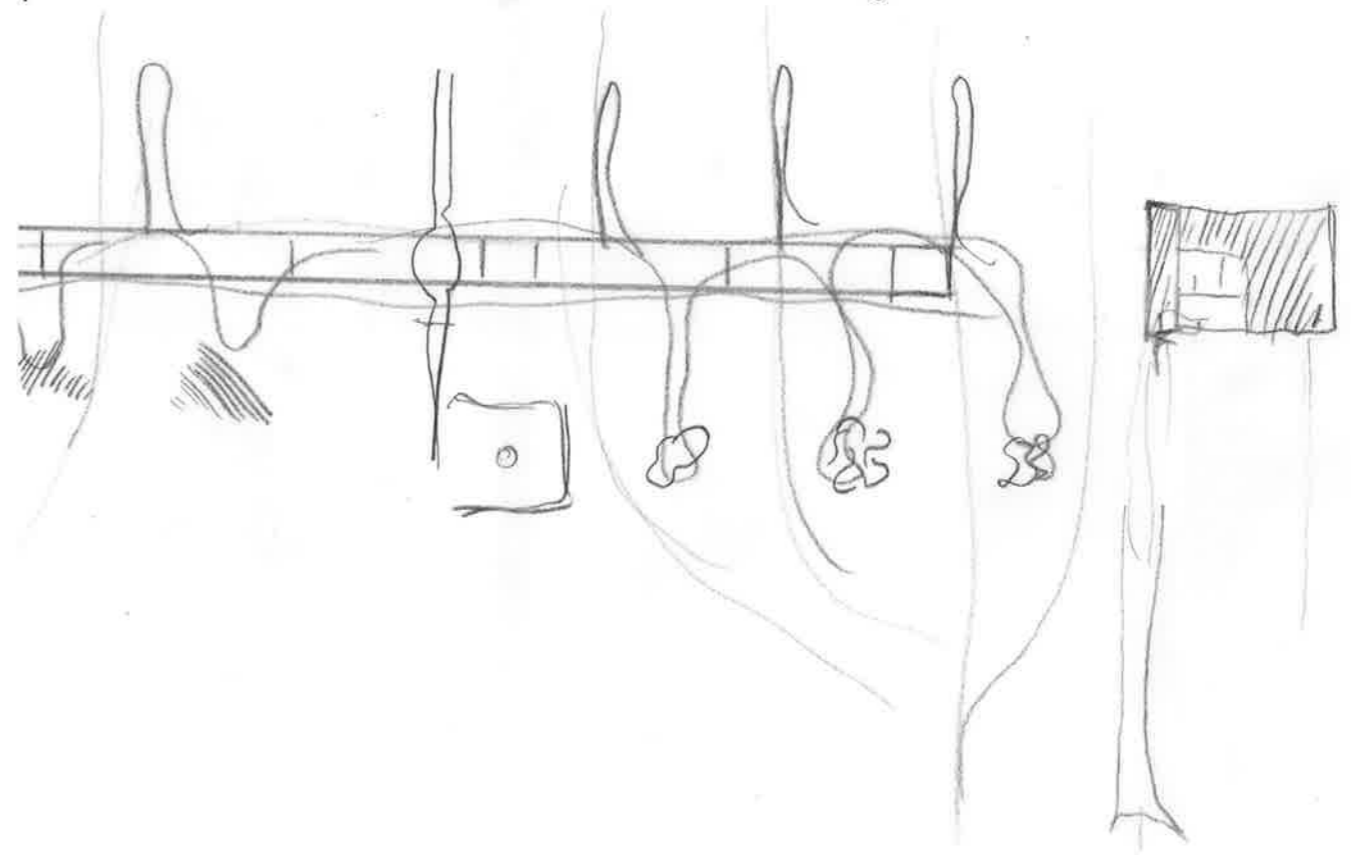

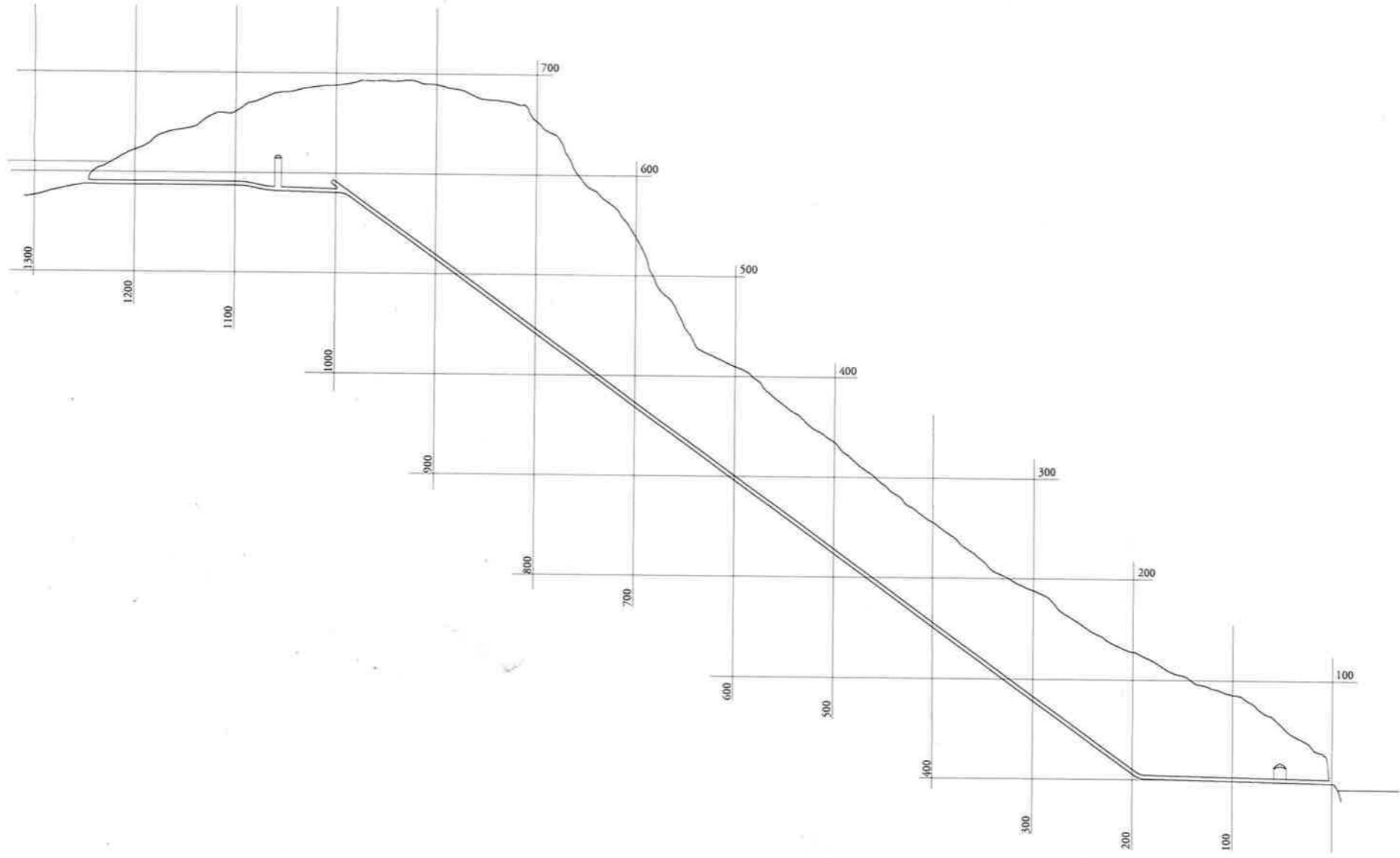

SAMPUNNET.

- "Limbota et gullgernt sted der folk i bo pi, sletta er flat og ipen og byssetamtene blir liggende slik at de får forholdsvis bra med sol"

= Bombilla? materiale er spennen.

- Alberts bokket. flyttet rundt der det var arbeid.

- Hvide dobbel pi begrensbrenn osv.

- ALBERT LARSEN. alberts familie.

- Diagrammer og planer over Hellen.

- 3D av Hellen. oppbyggings. 

- Når vannet renner gjennom. ved vake dør

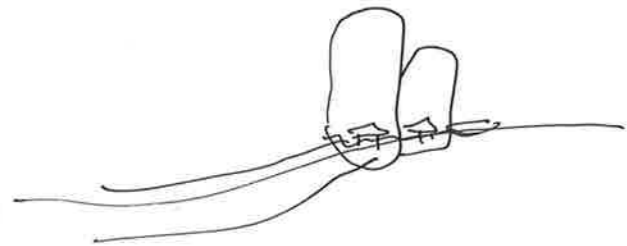

- Libeskind  
architecture and the machines

ex-pistols.  
god save the queen

Fjell Hellen

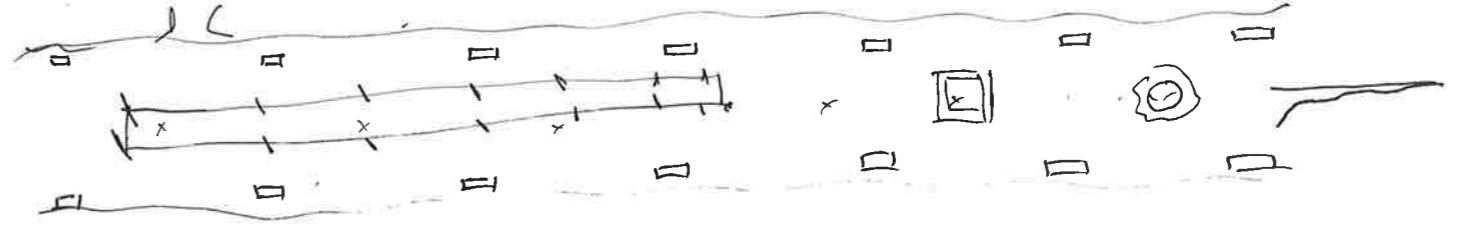

Rommet og Romsheten?

Klassisk oppbyggings. maskinens premisser

SHOW HISTORY THROUGH ARCHITECTURE

VALUE SPACE.

REPRESENT HISTORY, CULTURE, ECONOMY, CREATIVITY AND INVENTION. PERFORMANCY AND TECHNOLOGY  
STRUCTURE CONSIST OF HISTORY, REFERENCES TO ARCHITECTURAL THEORIES AND

This room. machines are the host and the people the organisms that use them to make it all work and deliver. ~~all is there for~~ every space serves a purpose, and it all is connected to the machines and is there to help the ~~body~~ human to get access to all the ~~parts~~ different elements that create his body.

- Kjenke tekster fra arkitektur om rom med maskiner?

- Innvendige byer følger maskinens og de som skal bygge disse premisser. Kan det som er modernistisk blir laget, og spesielt i fjellhellen, da det finnes masse og ikke leses til.

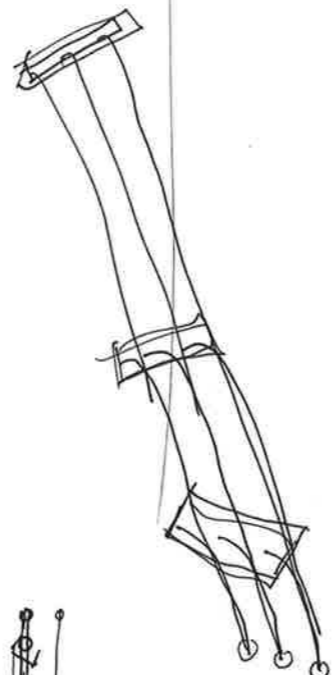

Rommet dette her slekter. Hva er det?  
Hvordan vil det være uten alle de "mekaniske" tilleggene?

- Fysisk alt utvannet en maskin 



kapic up

175 / stykker  
bomlister



175!



+ tegningene  
- programmet.

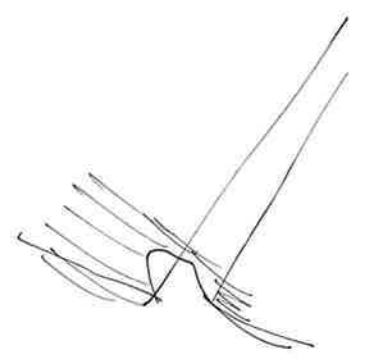
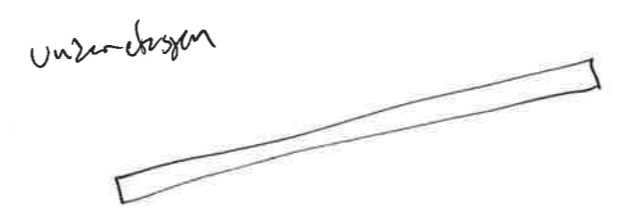
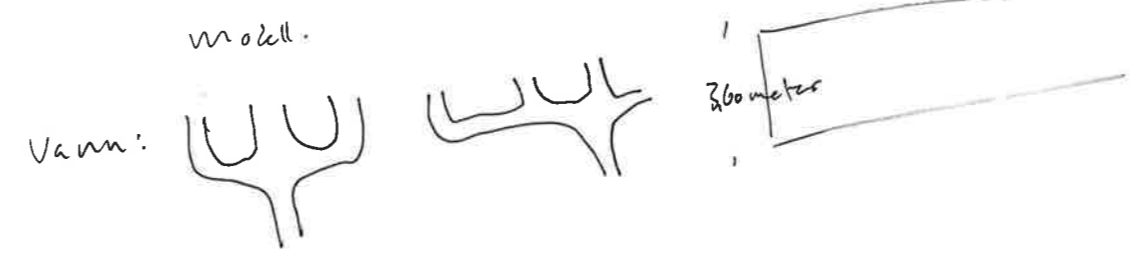
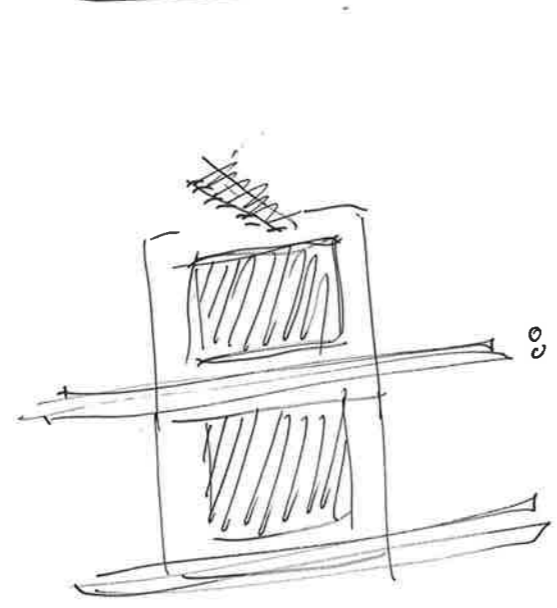
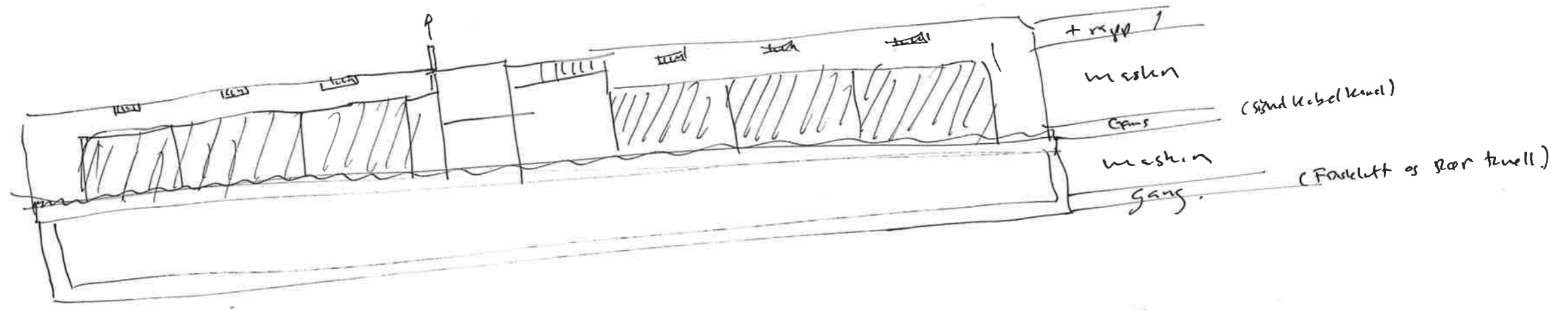

**Rom for overnatting:**

Dette rommet skal tilby  
inneholder 5 senger, et  
organisert som en sovesal

Rommet skal fungere som

**Plassering?**

- Inne i den gamle hallen
- Ute langs fjellkanter
- På innsiden av fjellvegge

**Informasjonslokale:**

Dette rommet inneholder  
og er ubetjent.

**Bryggen**

Det er to mulige adkomster til  
kumfunksjonen, hvor bryggen vil ha  
eventuelle servicevare

Fjellveggen møter vannet med en  
gjorden er på det dypeste 400 meter. I

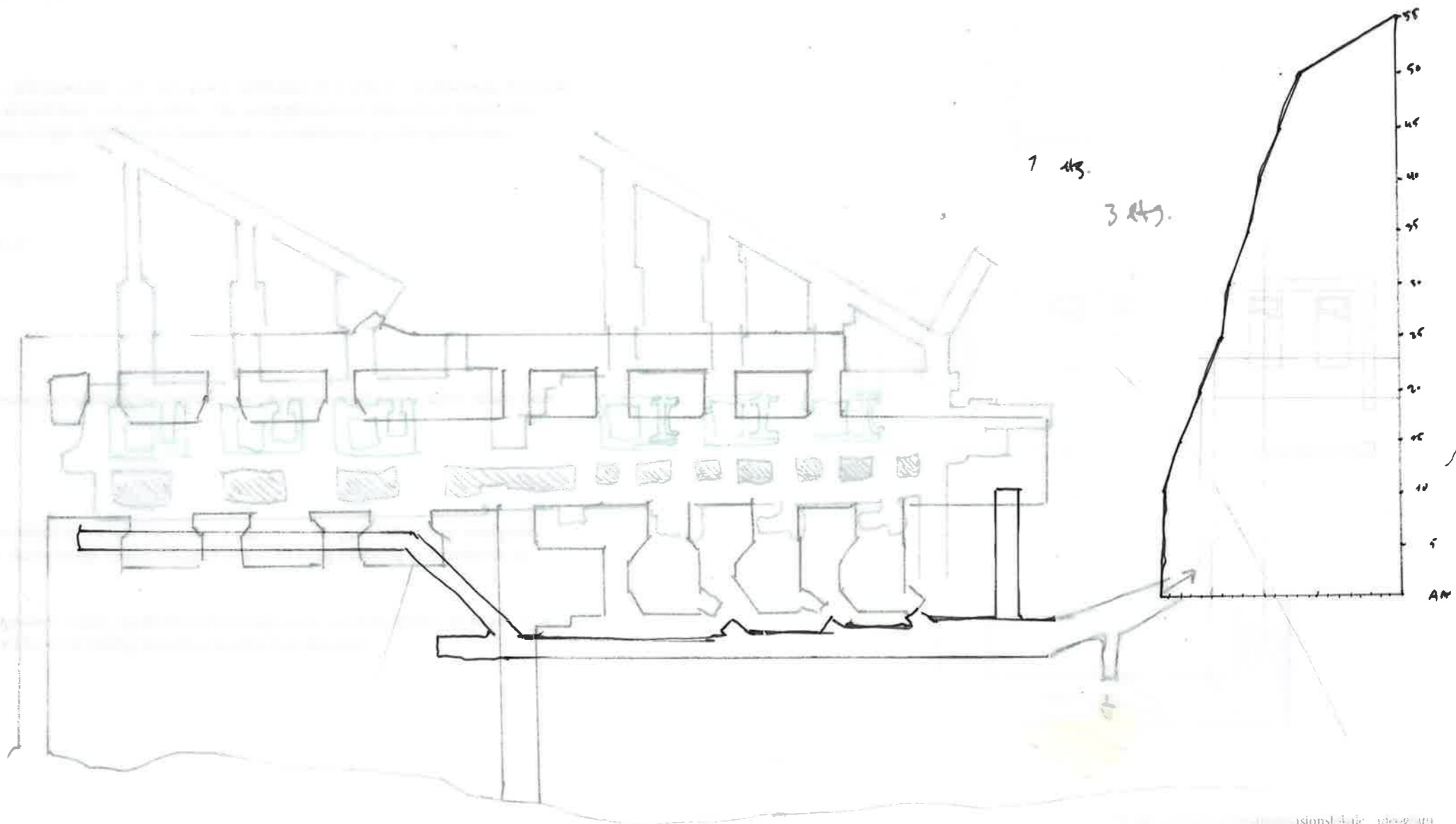

*Rom for overnatting:*

Dette rommet skal tilby turister muligheten til å overnatte ved/i den gamle fjellhallen til lysebotn 1 kraftanlegg. Rommet inneholder 5 senger, et lite kjøkken og et bad med dusj, vask og toalett. Alle sengeplassene er plassert i et åpent rom, organisert som en sovesal, og alle sengene har et eget skap hvor de besøkende kan oppbevare private gjenstander.

Rommet skal fungere som en kontrast til omgivelsene.

*Plassering?*

- Inne i den gamle hallen, om alt utstyret tas ut.
- Ute langs fjellkanten.
- På innsiden av fjellvegg

*Informasjonslokale:*

Dette rommet inneholder informasjon, gjenstander og bilder fra lysebotn 1 kraftstasjon. Rommet er åpent til alle tider og er ubetjent.

*Bryggen*

Det er to mulige adkomster til Lysebotn1, en bilvei og via båt. Jeg ønsker å lage en ny brygge i forbindelse med publikumsfunksjonen, hvor fergen vil legge til et ekstra stopp. Denne bryggen er kun til av og pålasting av besøkende og eventuelle servicevarer.

Fjellveggen møter vannet med en nesten 90graders vinkel, og det fortsetter langt under vannoverflaten. Dybden i Lysegjorden er på det dypeste 400 meter. Dette vil ha en betydelig innvirkning på konstruksjonen.

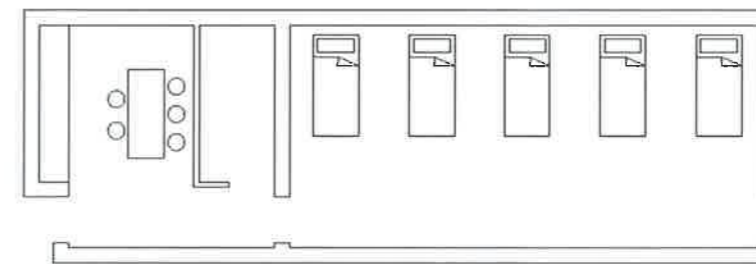
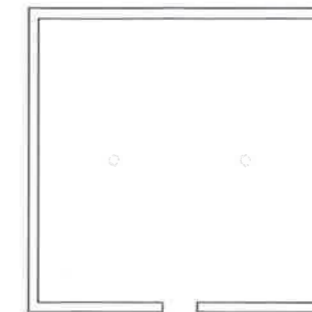

Brygge, overnatting og informasjonslokale - ideogram

Bedstue? Værelse  
Duv

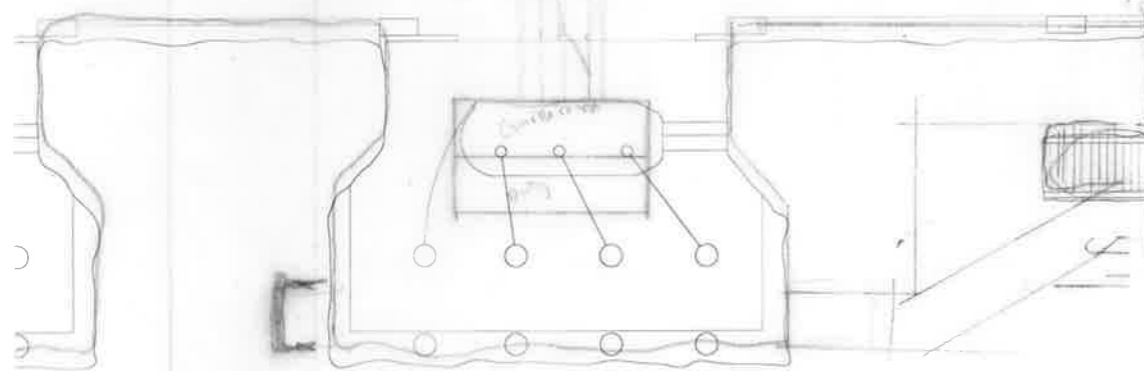
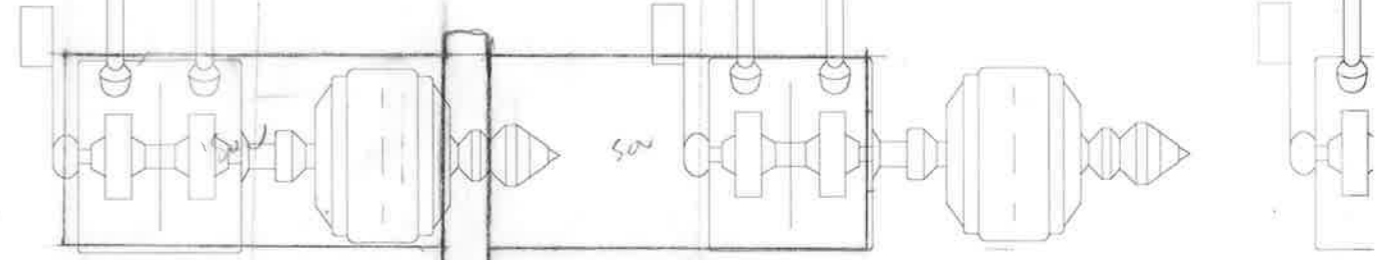
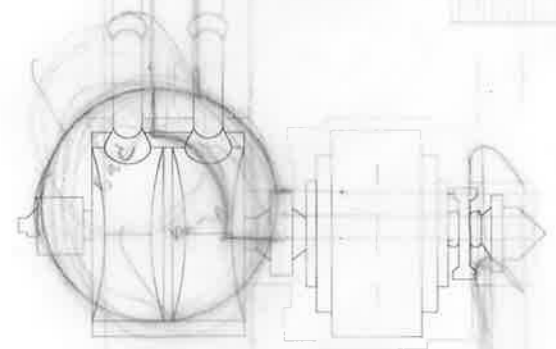
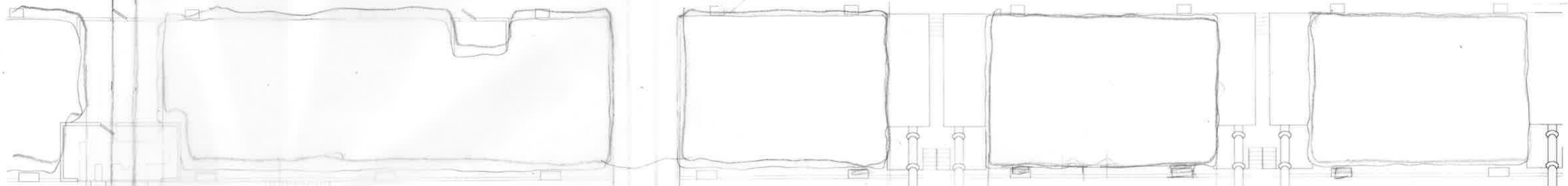

310

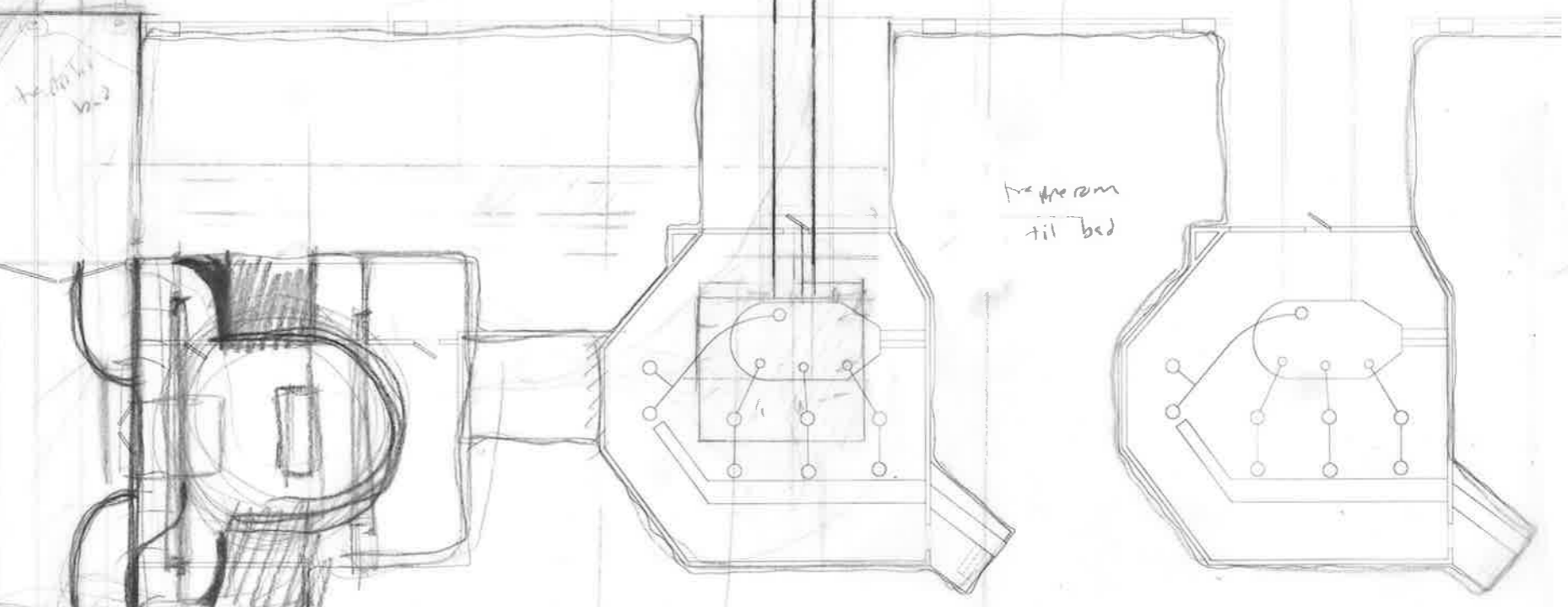

tegnings  
v. 2

tegnings  
til bed

566

A

2,56 = 16 tæpper

A1 Rom for overnattings

vel. h.konst.

st.

not.

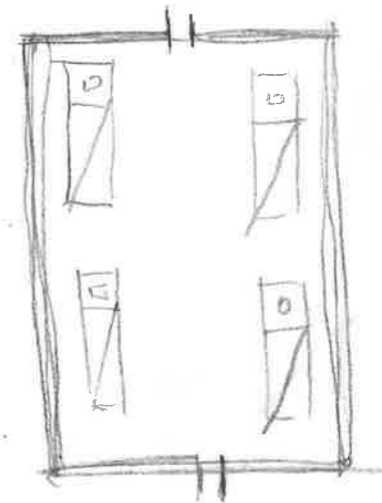
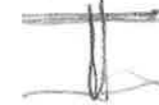

4  
6  
7  
9  
10 800

v. vac  
når kan

komme, vare

Rum for overnattings som  
ville. utbygget.

R 2 Gulberig åpnet

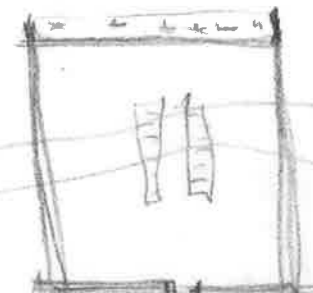

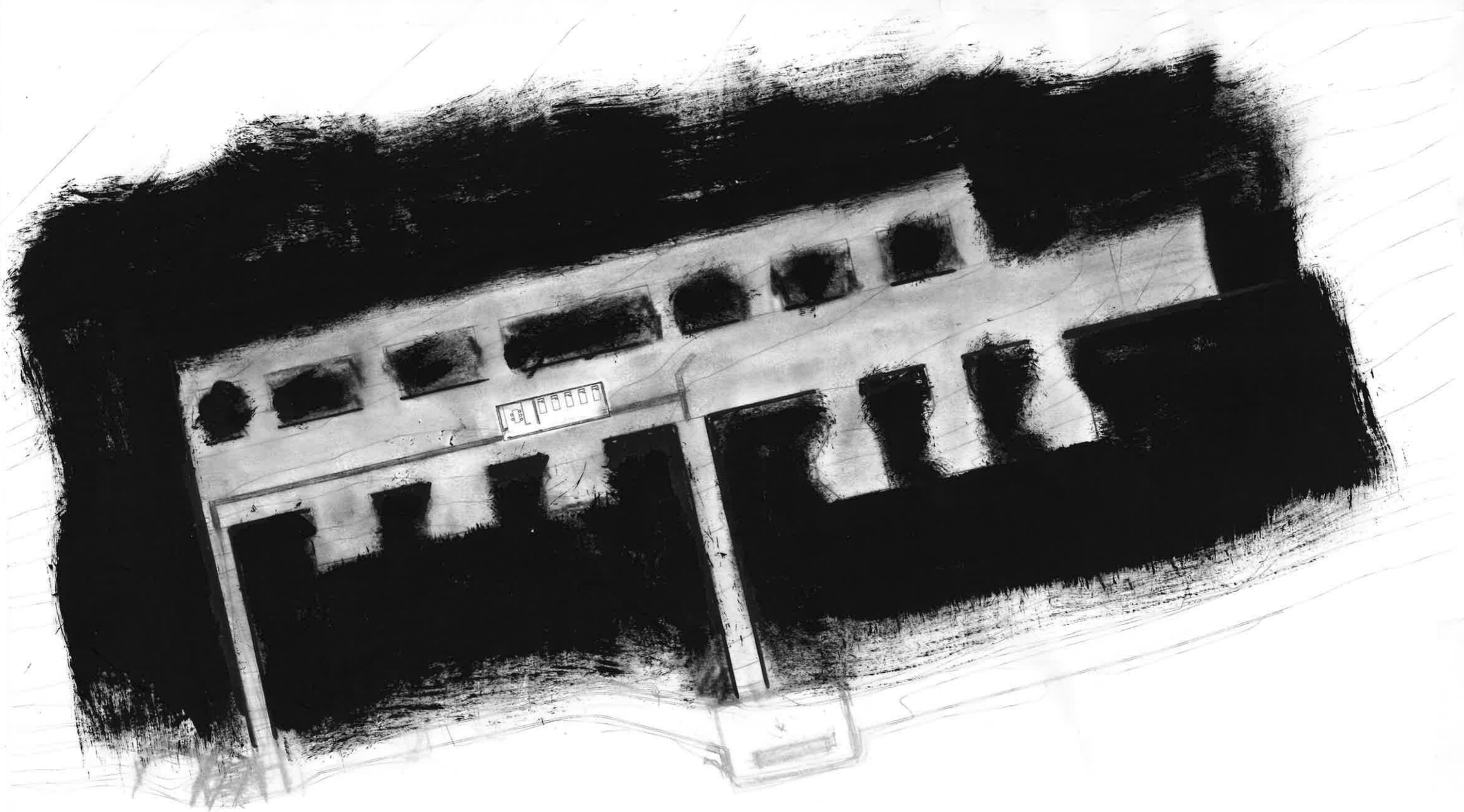

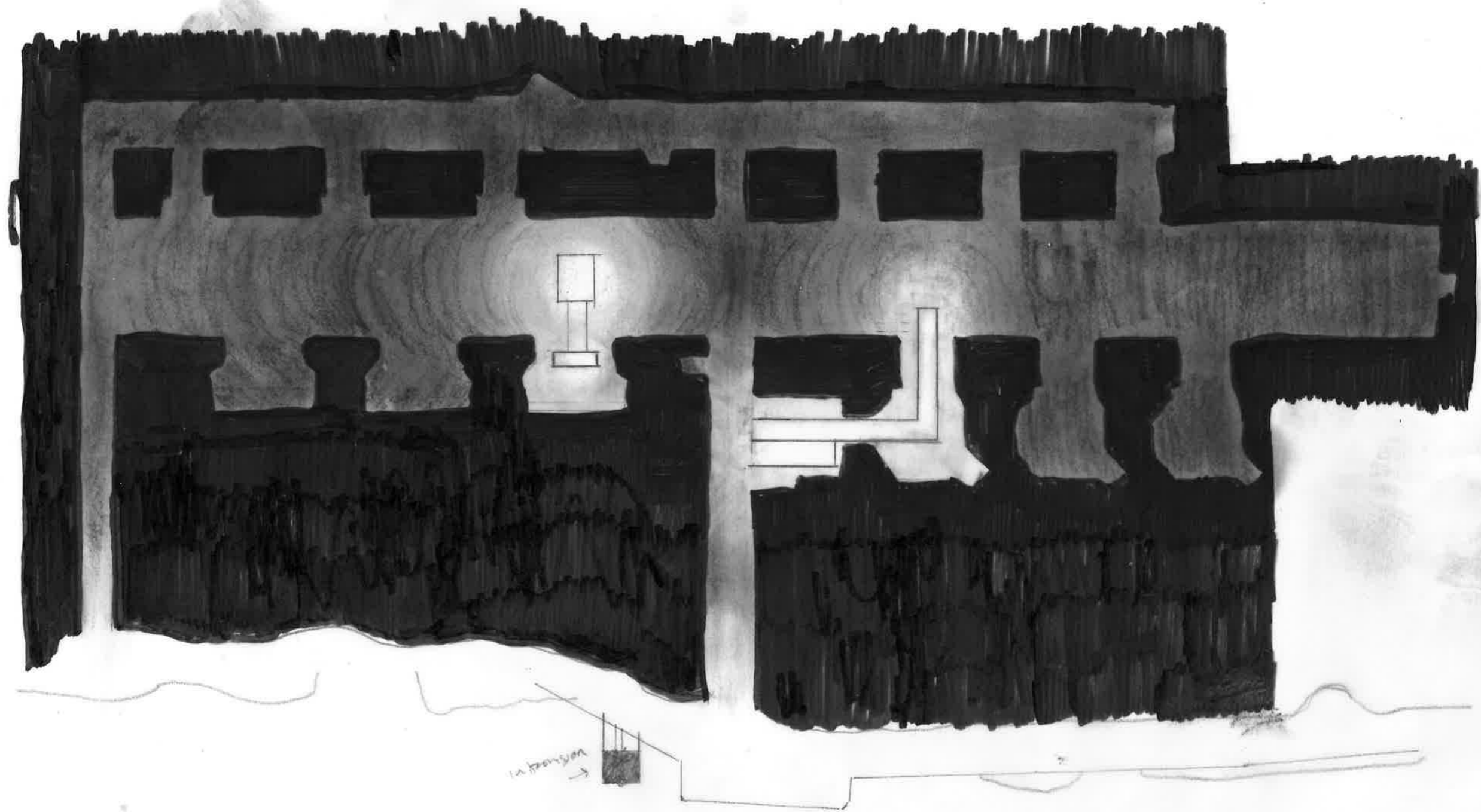

BETON OF Beton structure

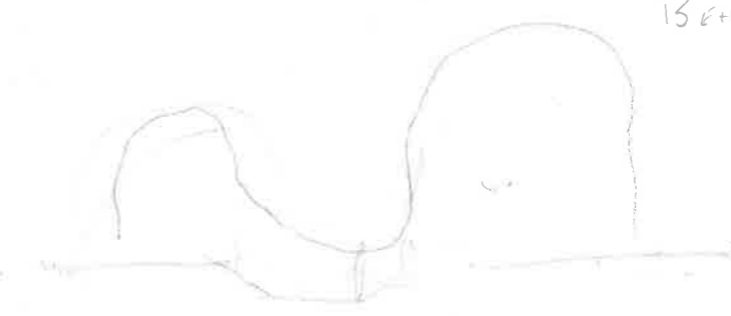
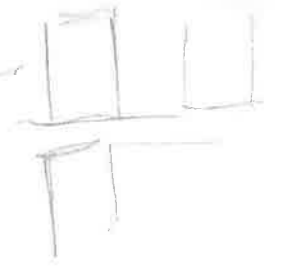

A1: 594  
891

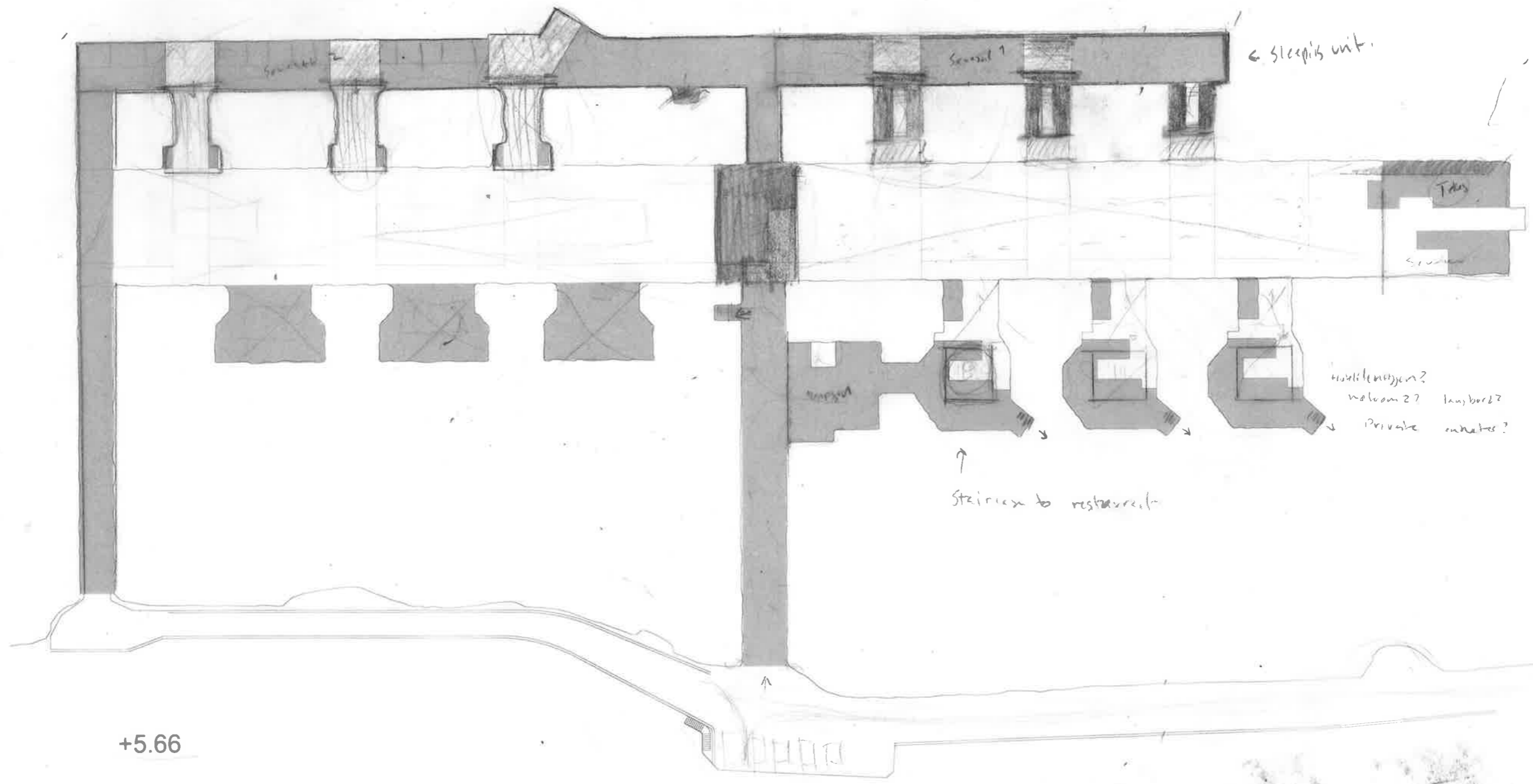

← sleeping unit.

Section 1

Tray

Staircase

multitenancy?  
welcome? lounge?  
Private entrance?

↑  
Staircase to restaurant

+5.66

1:500



Luftkondensator

Grunde 21 / spa  
Mantel / 40

Höbel

1/1000000

Person  
Medien

+5,66

↑ service

B35

18x1500

1138

235

235

↑  
Hochdrängen

2,56

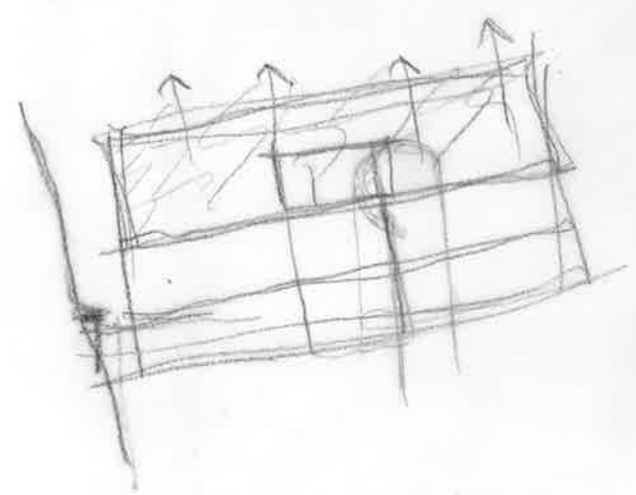
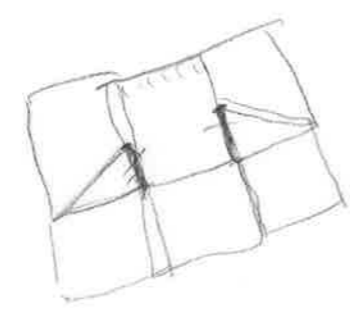
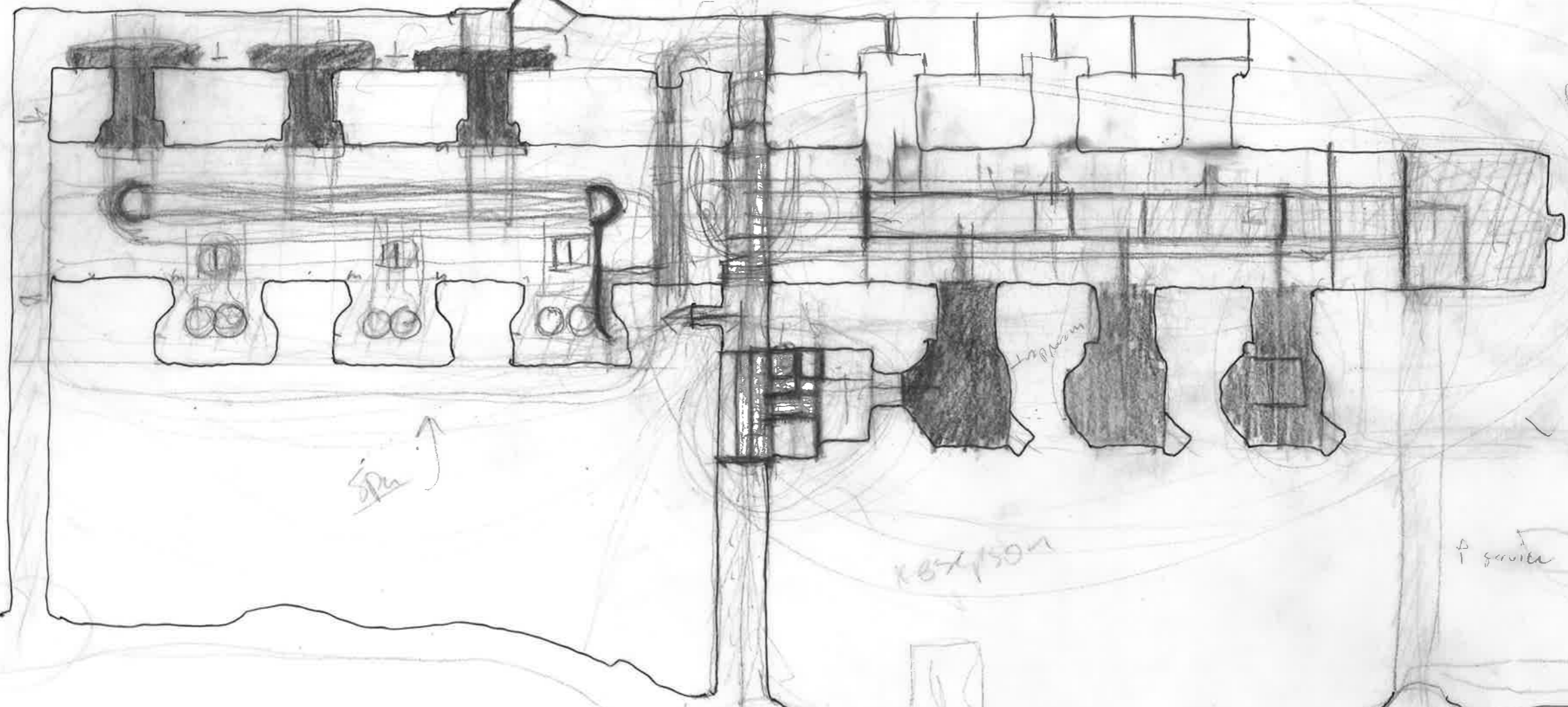

Handwritten scribbles or notes in the bottom left corner.

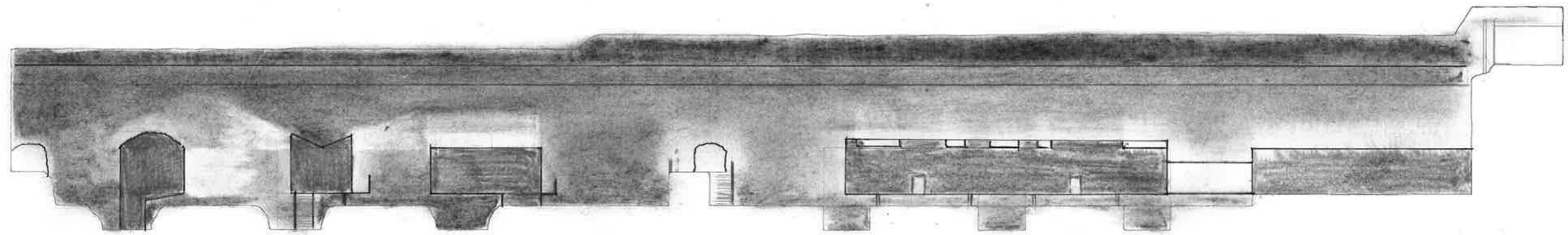

# STRUKTUR & TEKNISK

## Fjellhall

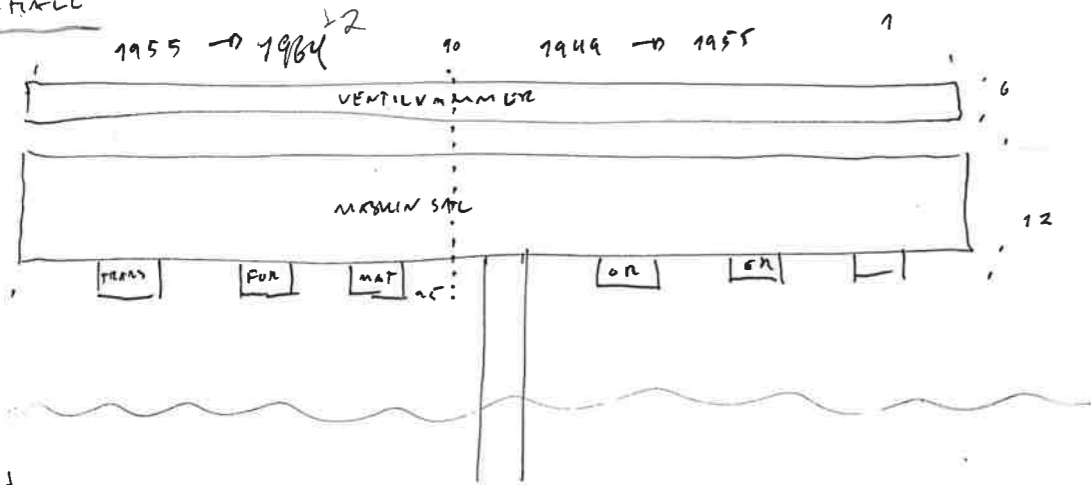

- i fjellet.
- SPRENGT UT.
- hømt i vannet uten for.
- gan rett ned.
- Parallell med vannet.
- 23 000 m<sup>3</sup> fjell ble sprengt ut.
- FORVÅRSE PÅBEGYNT I 1955, utilet 60 meter mot vest.



## TURBINENE

- HORIZONTAL AKSLET, med to løpetrull med to pålra



- Generatorene er montert med vannkjøling og kullsyrebrannslukning.

## TRONSHOLEN 2 KEMTLEDDNINGER

- BARDNERTE, IMPREGNERTE TRÆSTOLPER
- GALVANISERTE TRÅVERSER OS FE-A7 120 LINER
- I DATI PÅ KULTURMINNELISTE.

## Dammene

morene lettning. - lussvater  
Breana - 45 meter høy dobbeltkrone med dem.

## Konstruksjonen.

- en stol inn i topparket.
- massive fjell i en sjakt til undervannsfunkten.

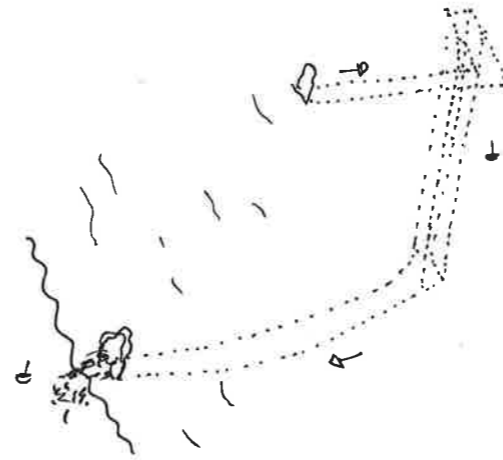

- BROTEN MELTET STØPES



- REFRAN AV HITALLEN SPRENGER ~~fjell~~ uten fare for steinsprang



## Med rør

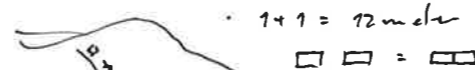

- 1+1 = 12 meter
- FIRT NED.

- 8 tons MAN-spill (?)
- Rørene blandet på topp os fraktet ned i transportvegg
- Fyllt rundt røret ved hjelp av støvvibratører i betongmasse os på innside av rørene.
- 12 meter rør pr dag. 194 desember - 1940 meter.



## RØRGÅREN I TRYKKSJAKT KONSTRUKSJON

Rørleder: 6m lange  
3-6 tonn pr stk  
totalt 820 tonn.



## FRÅ STØRFJERNING:

- 1100 meter lang.
- Helling 35°
- SPILKEBØRNINGENS DIAMETER: 2,0m
- RIKTEKUNNSK: 10 mm øverst til 18 millimeter nederst.

BESATNINGEN TIL SVEITS & ØSTERIKE  
70 arbeid i 10 timer - 415 mann pr  
52,2 timer os 18,7 kg sveitstift  
per meter sjakt.

## VEIENT I ADKONST.

- Lysebotn → muskivsalen.
- smal hylle i breitt fjell

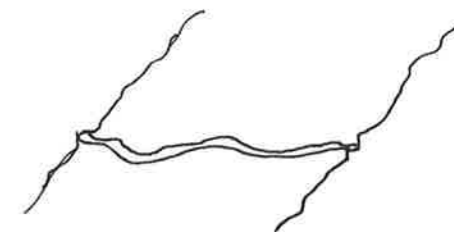

- Ble bysset egen kai til metagjete av rørene i lysebotn.

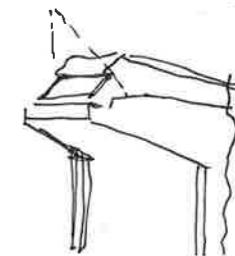

## FORLENGELSEN

- Forlenget galen os kapasiteten i 1955 allerede.
- Ni Tonell, grense for inn fra vest.



- Kranen kom på plass

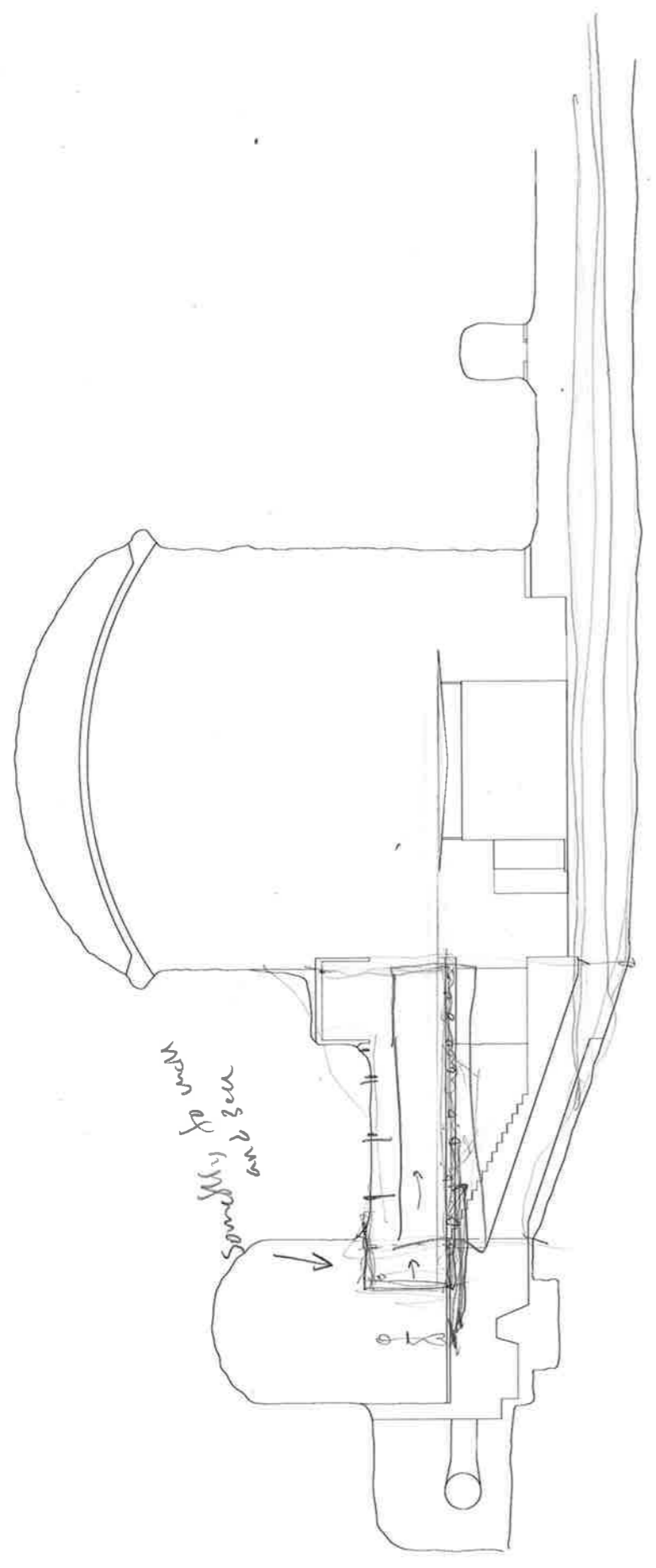
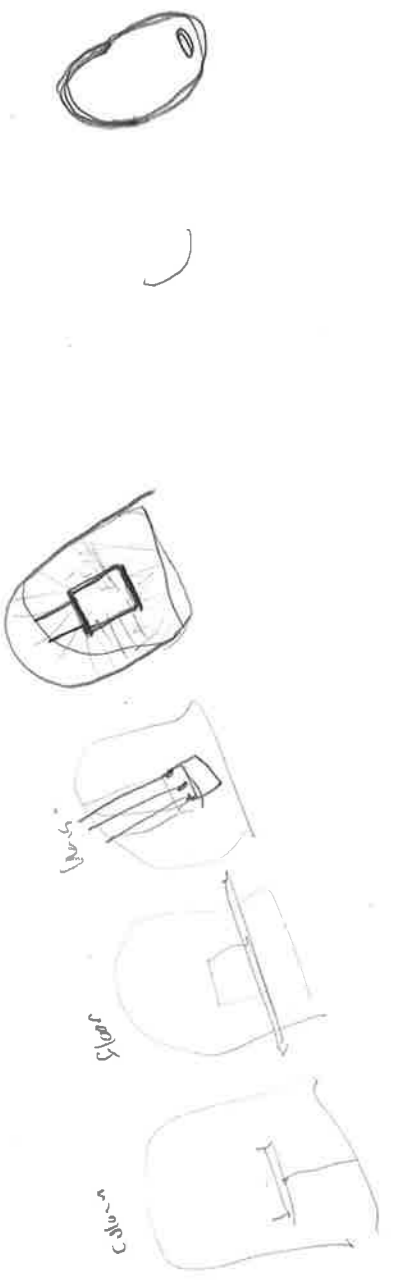

Hand-drawn  
something to  
and see

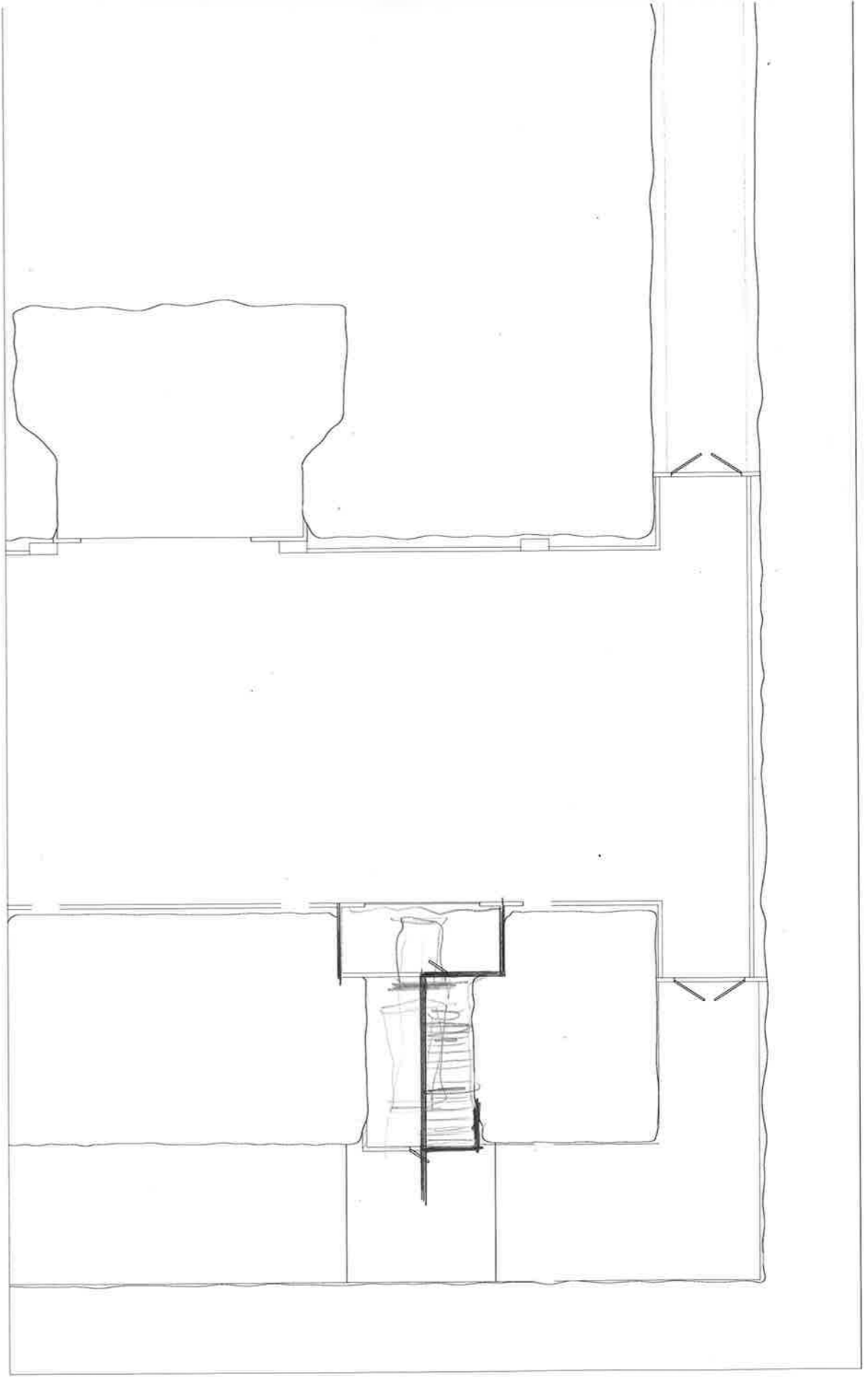

Hydro 2000

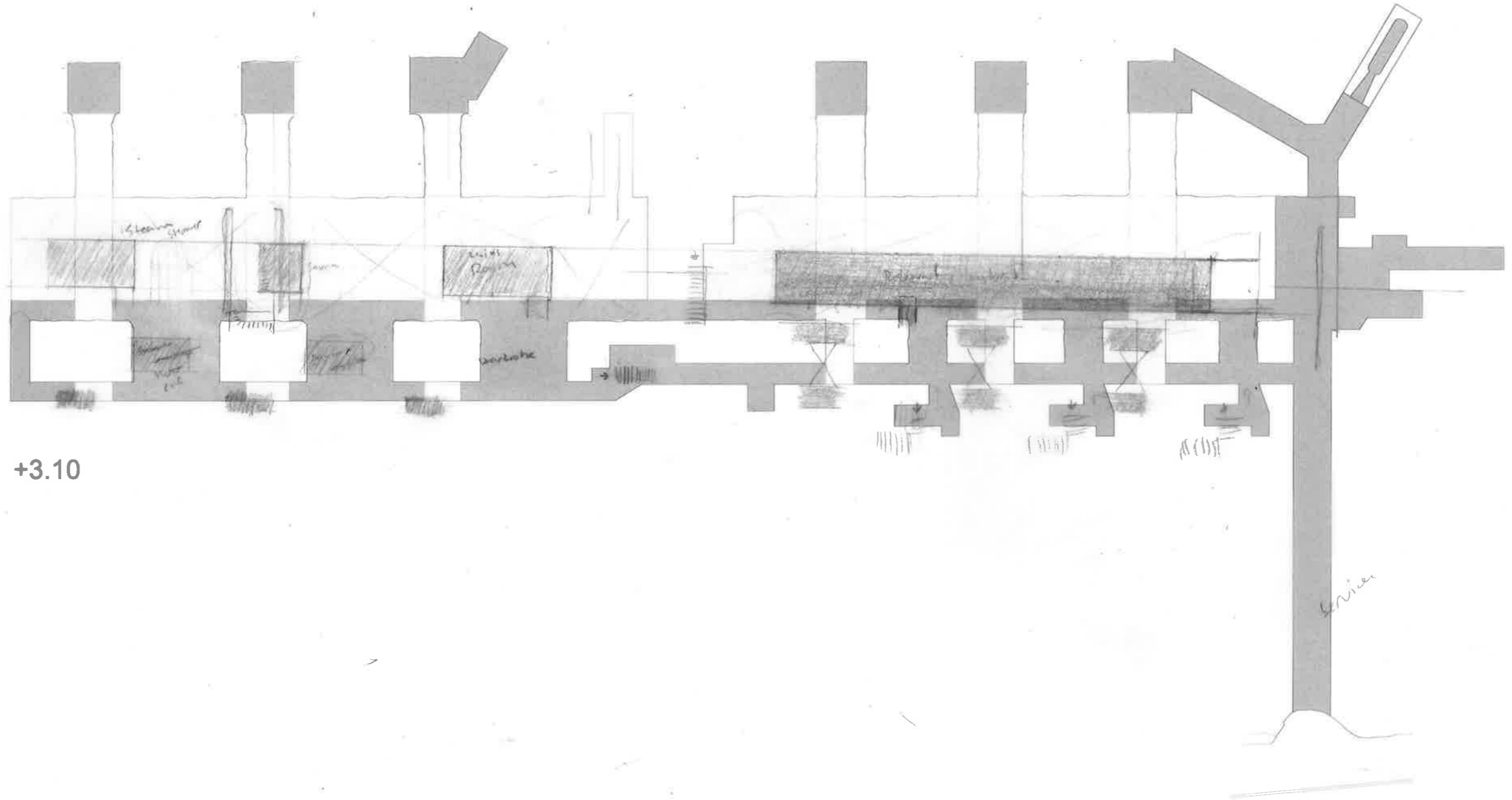
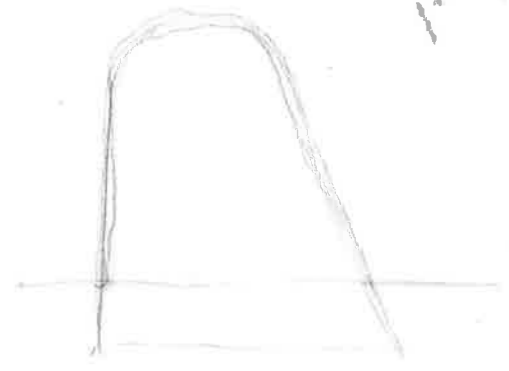

+3.10

$\times 5.66$   
 $\times 3.10 = 16 \text{ steps}$

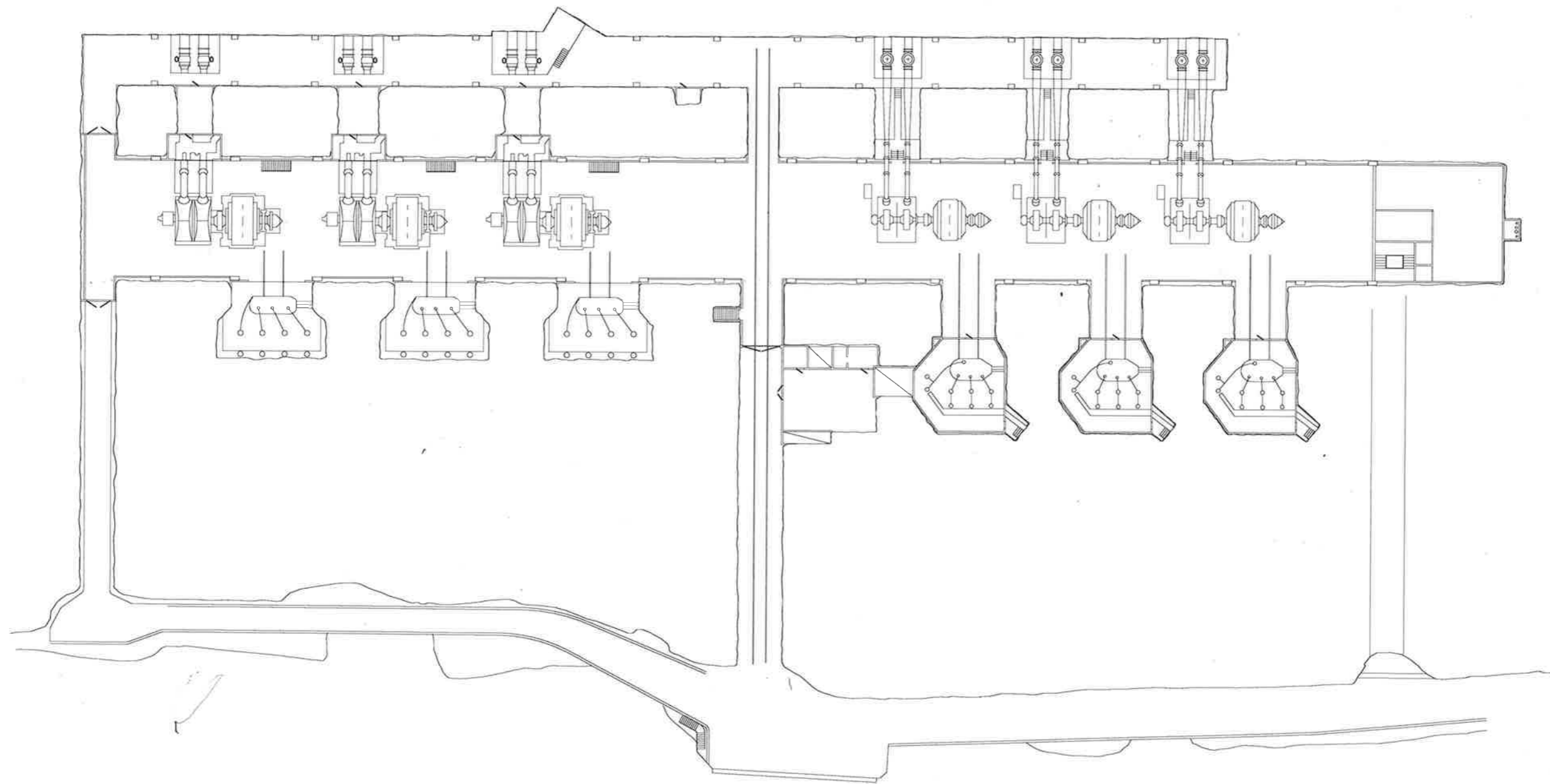

+ 3.0  
+ 5.65  
+ 7.00  
- 0.5

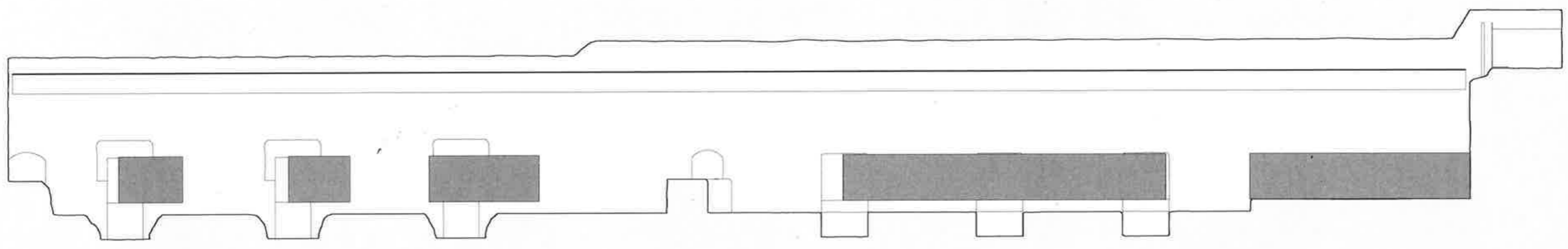

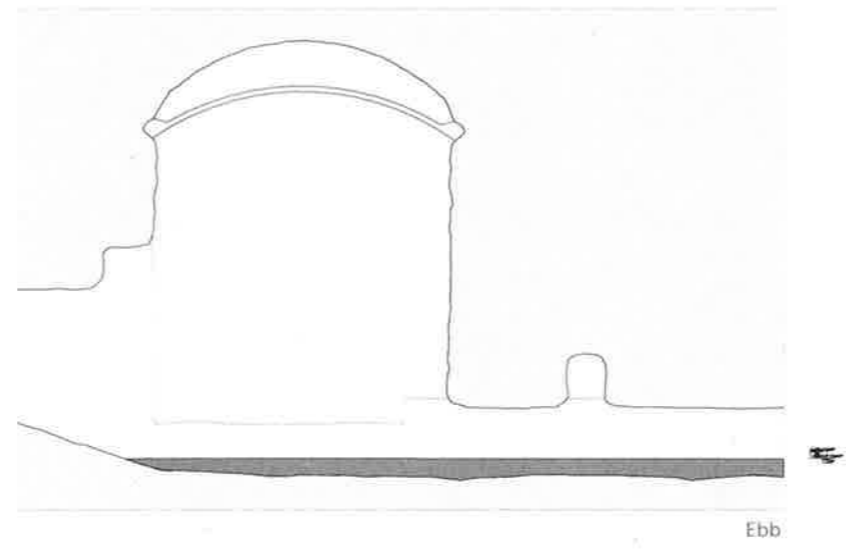
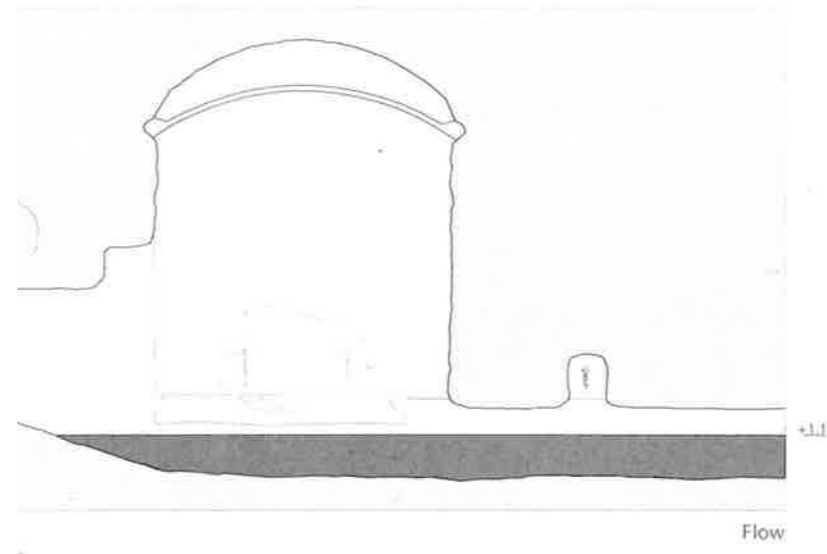



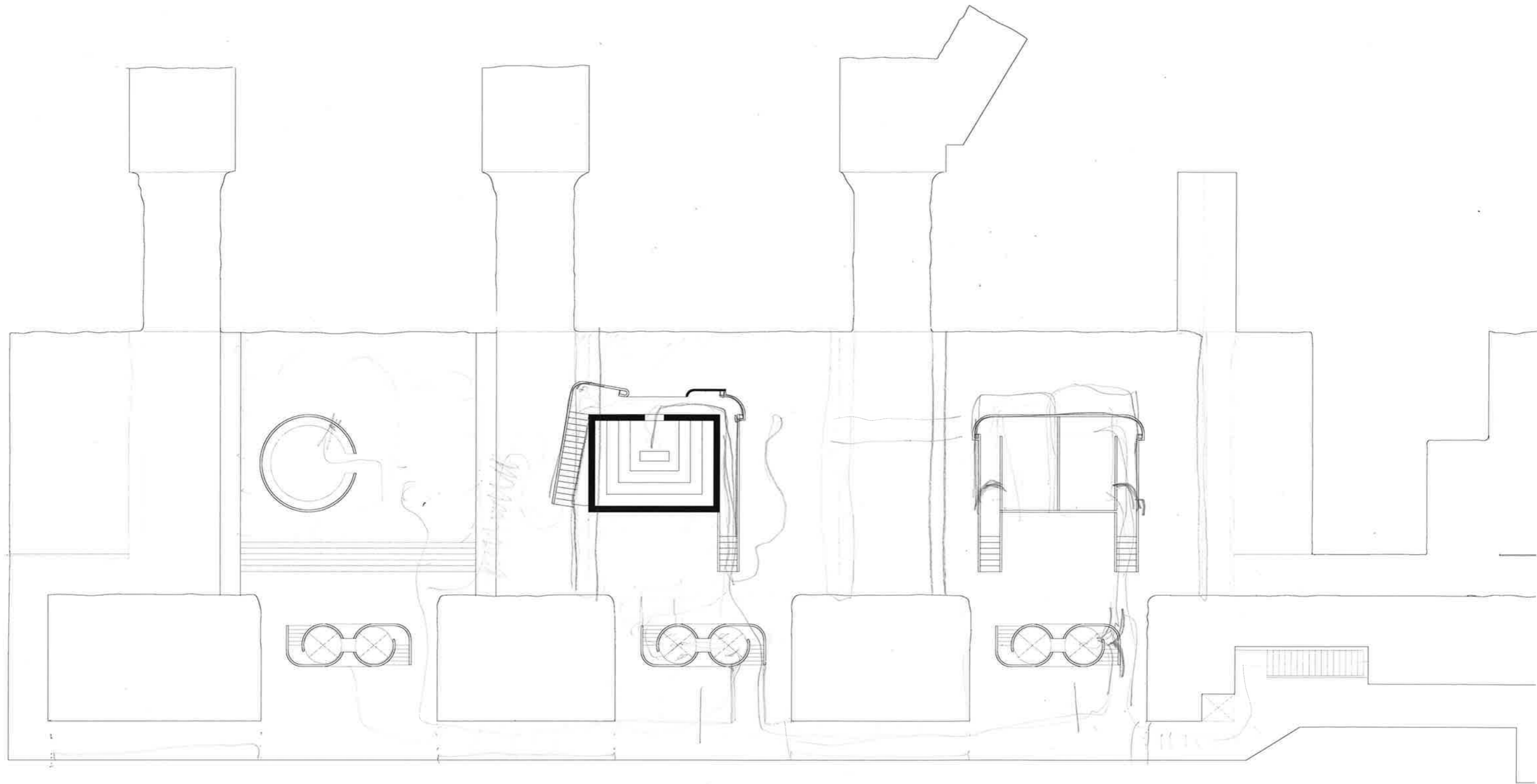

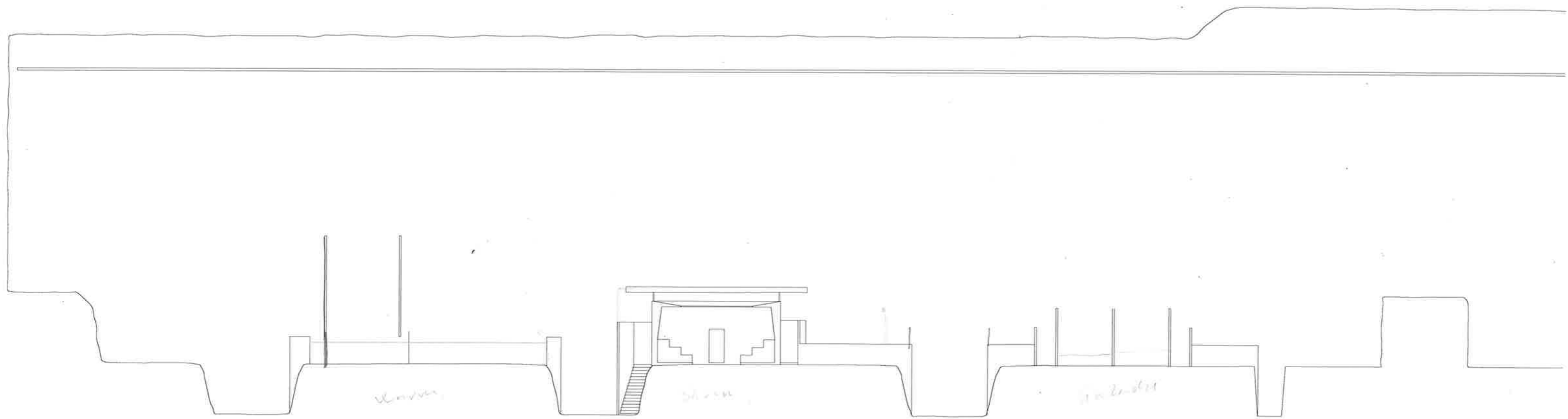

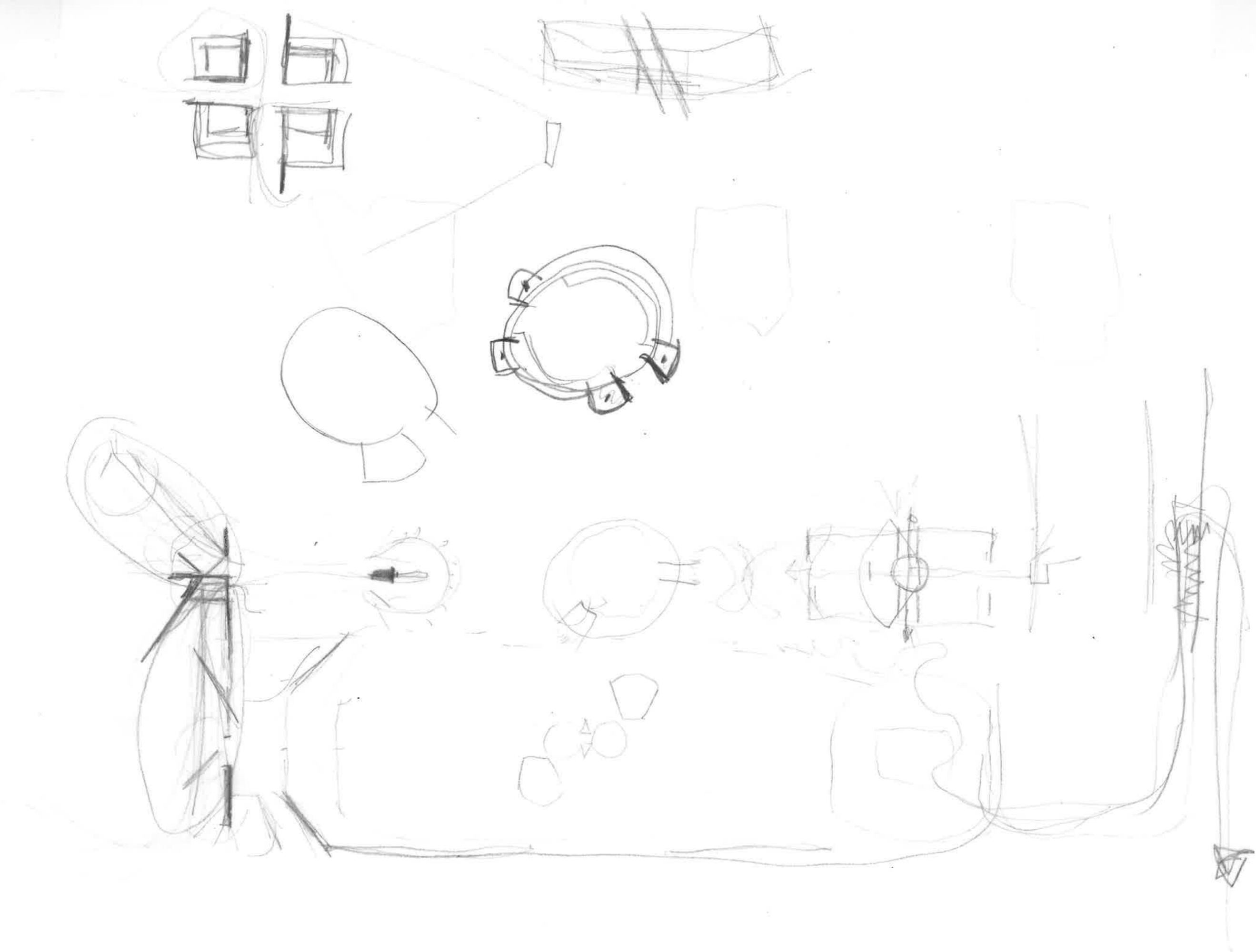

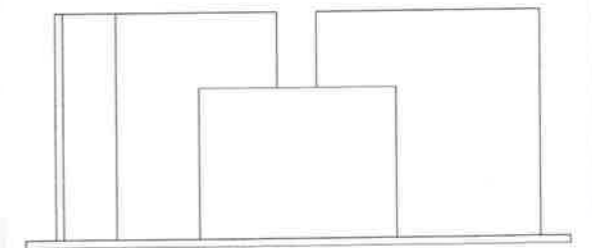
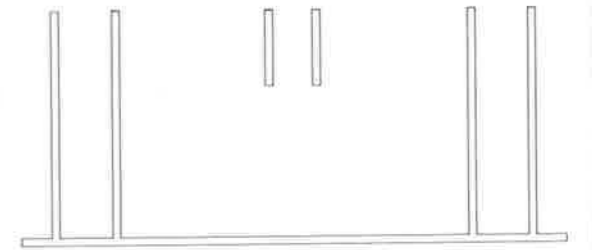
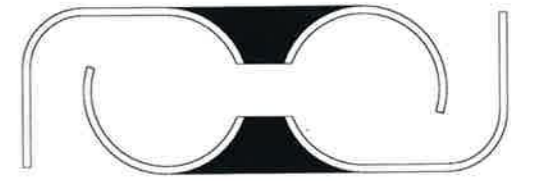

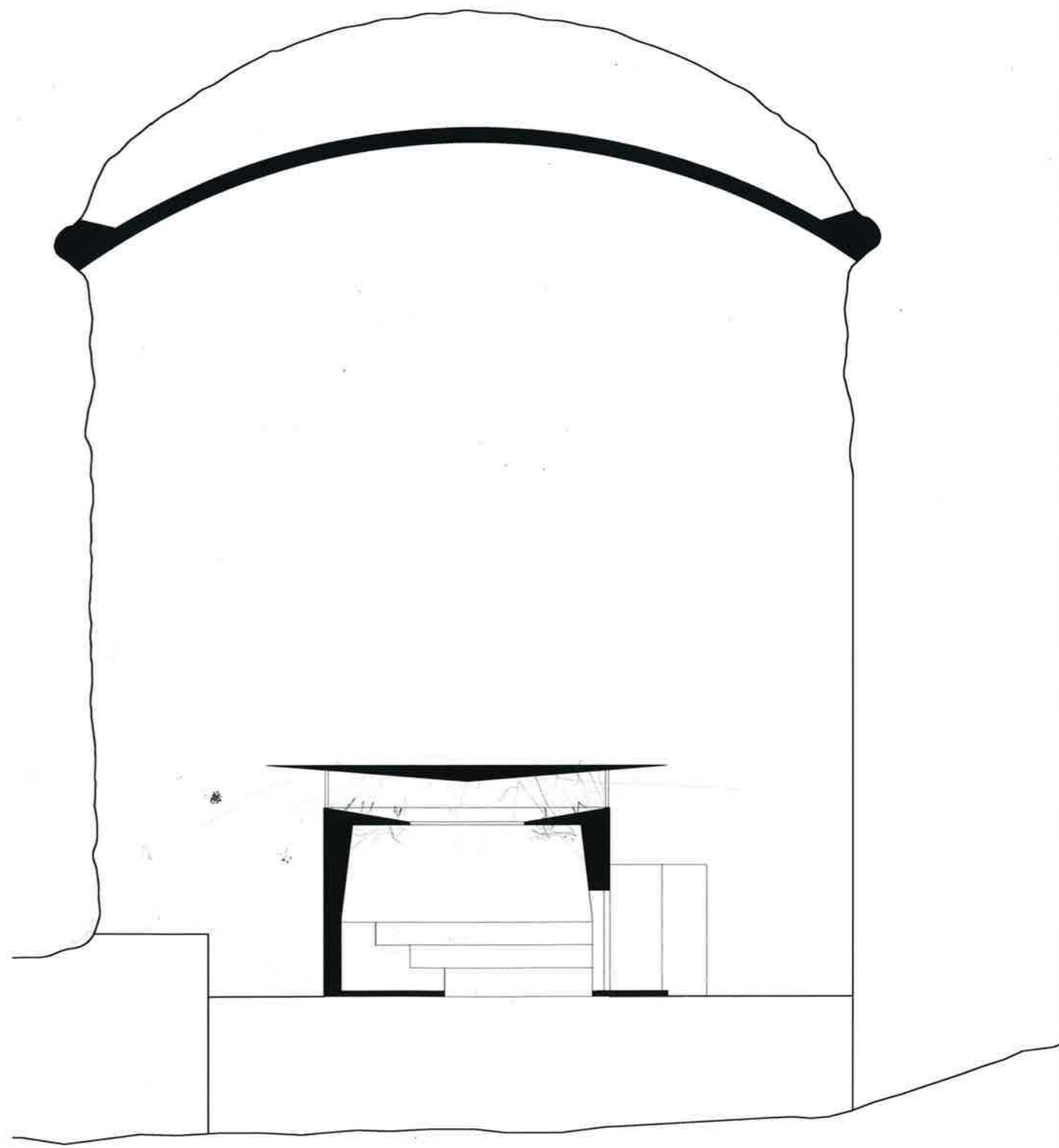
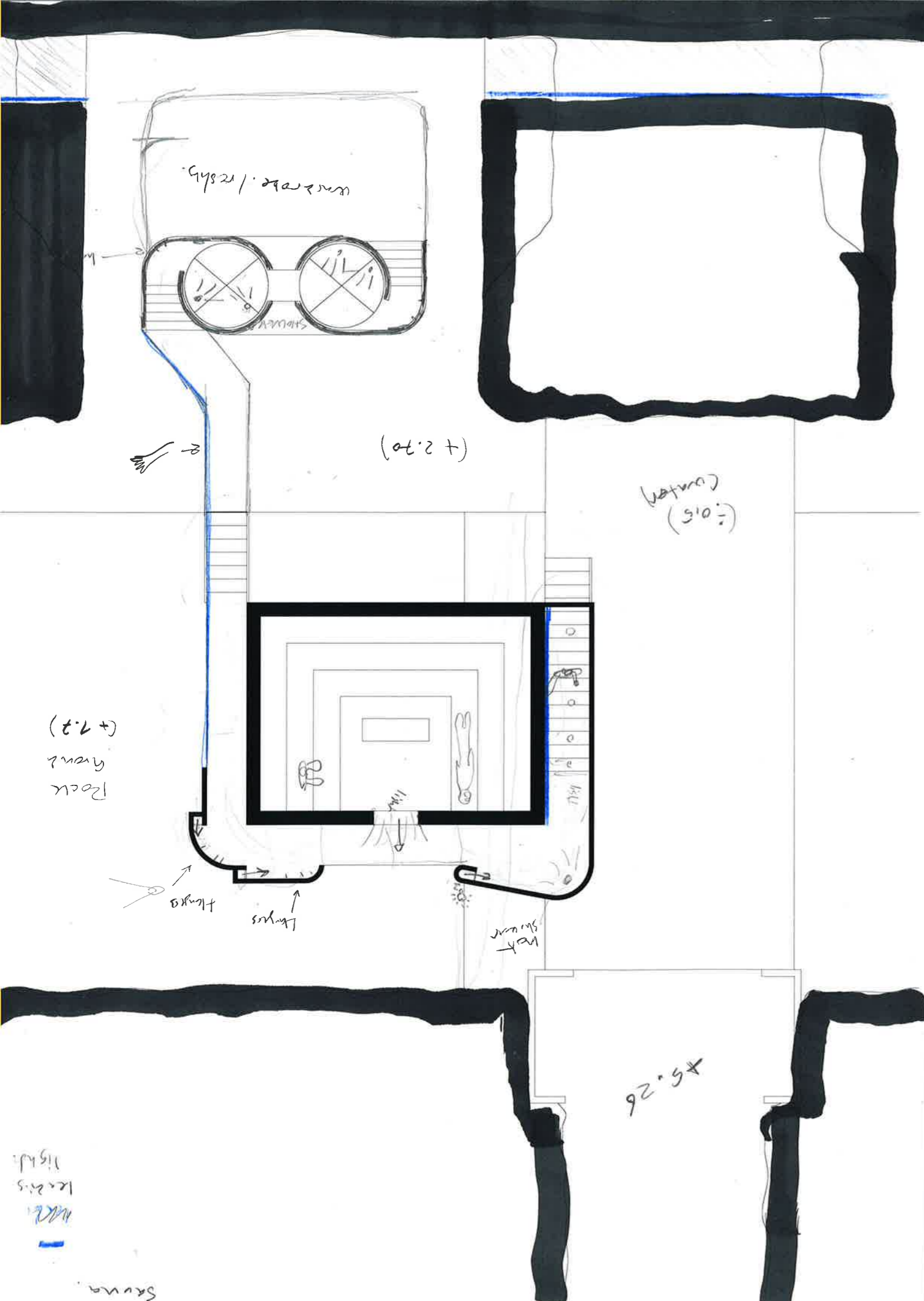



light to see if there is slow in the room

STAIRS THE DRAW  
5 sum fig.



Detail view



Traffic loop

Walls

f su

end of it 10 pm?

steeply down

room

area 2

area

to floor

light area

WC shower

stairs

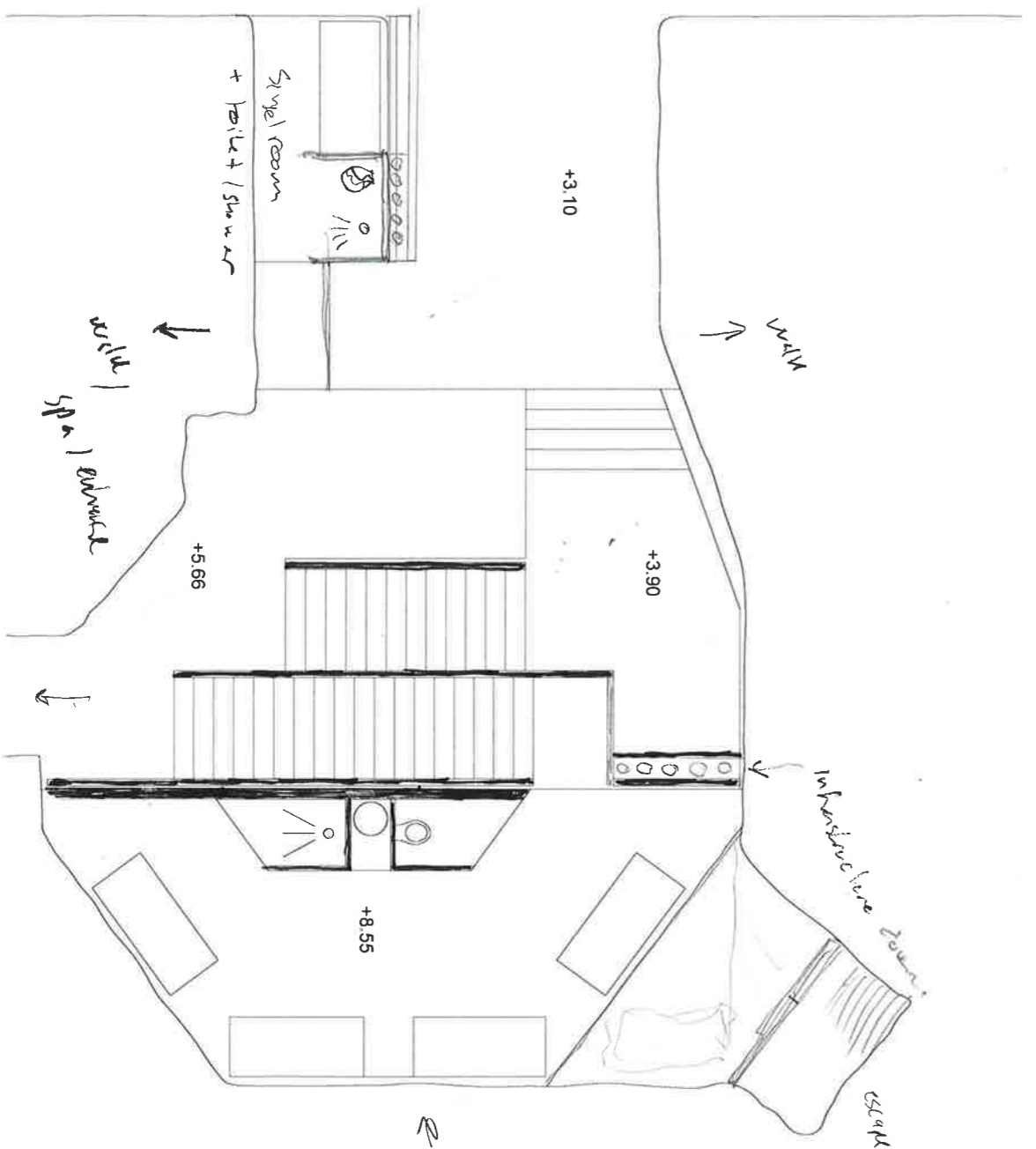

← Clearing  
 ⇒ people  
 + Shower / toilet  
 \* 3 =  
 21  
 + 3 = 24  
 + 12  
 = 36

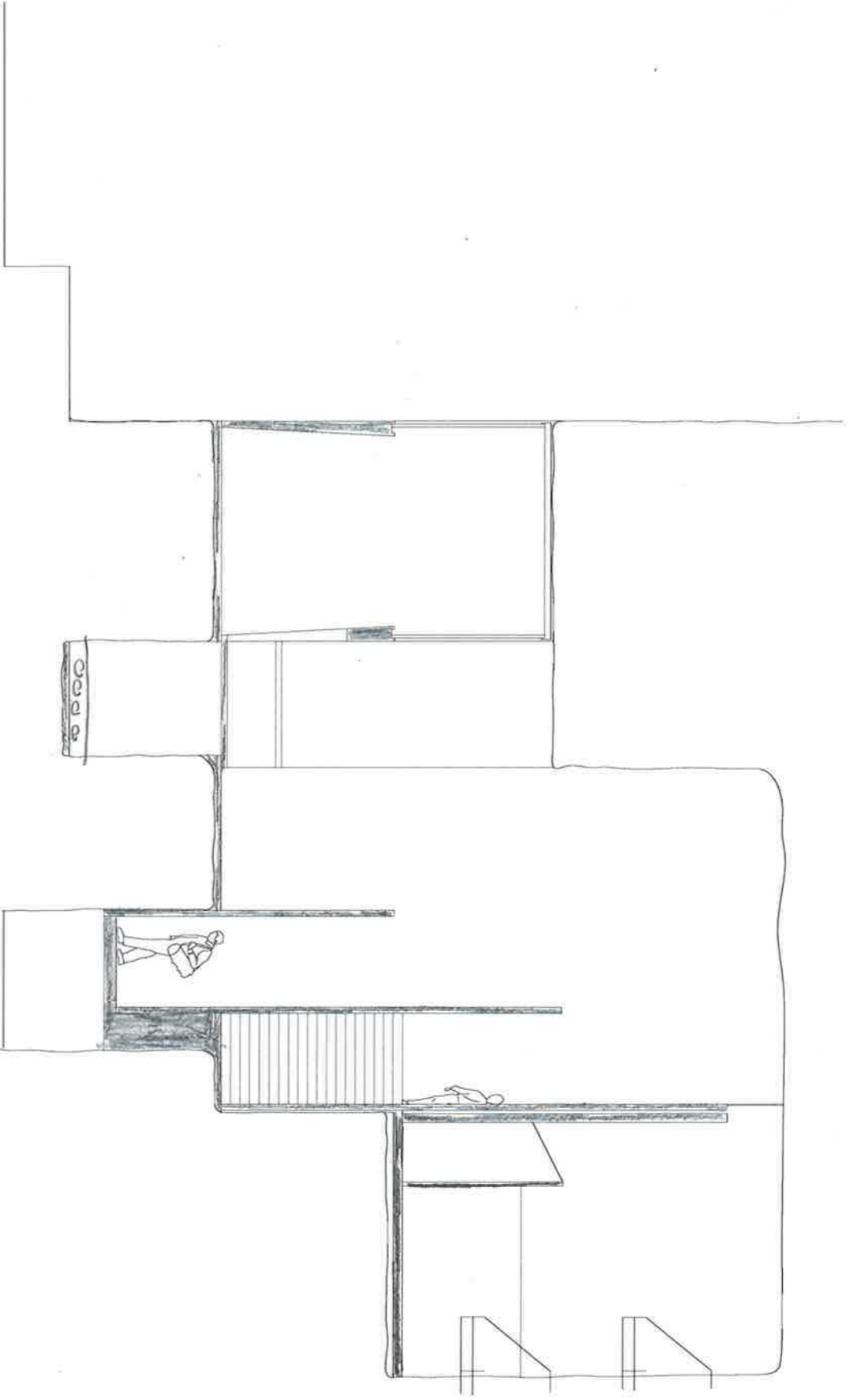

"Kloppes kurb"  
 inspired by  
 wooden disks.

TRANSFORM ROOM 2.  
Fartley. H1  
Plan

To lawyers? and to work away from  
concept about the scale of the  
rooms

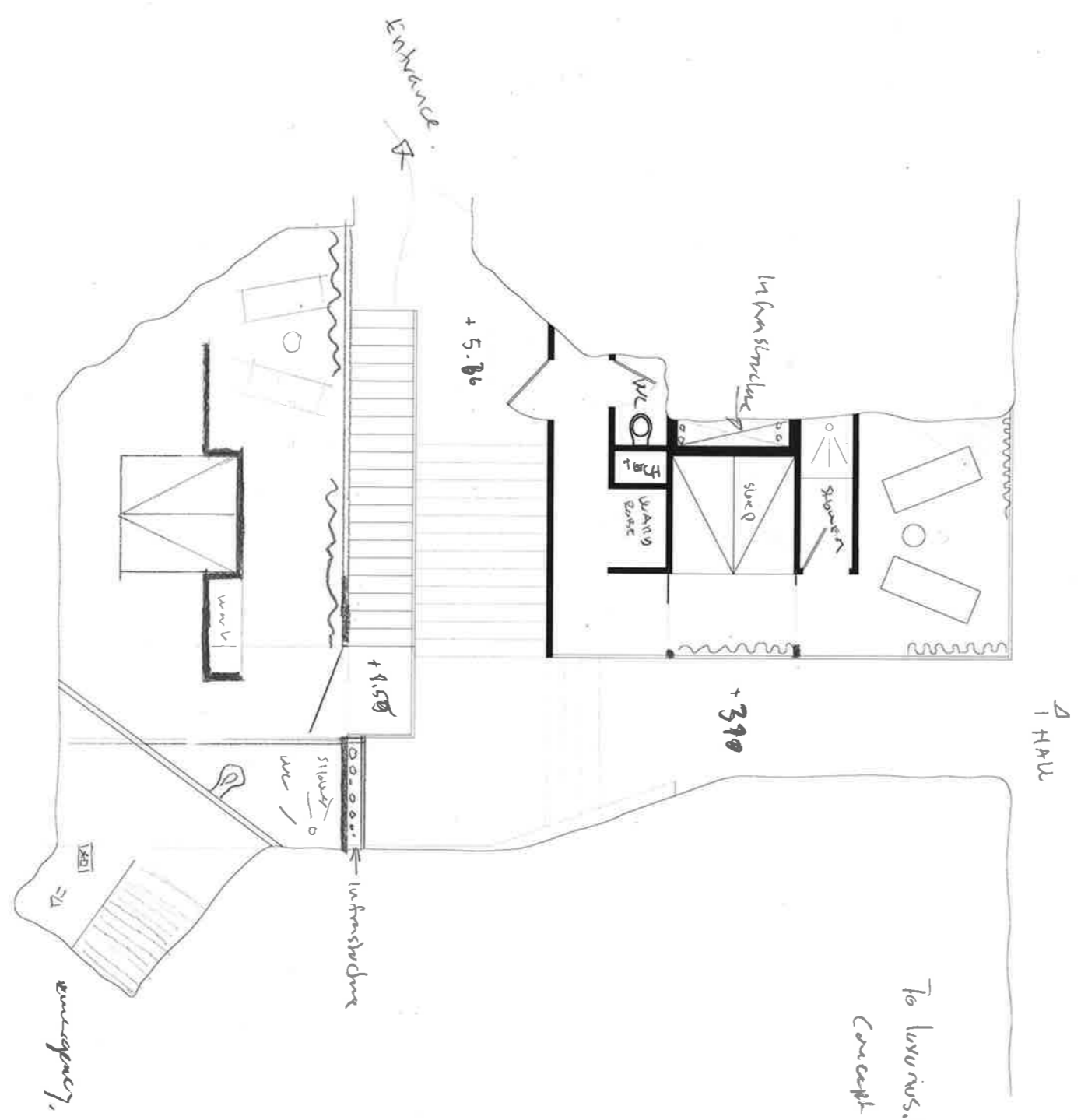



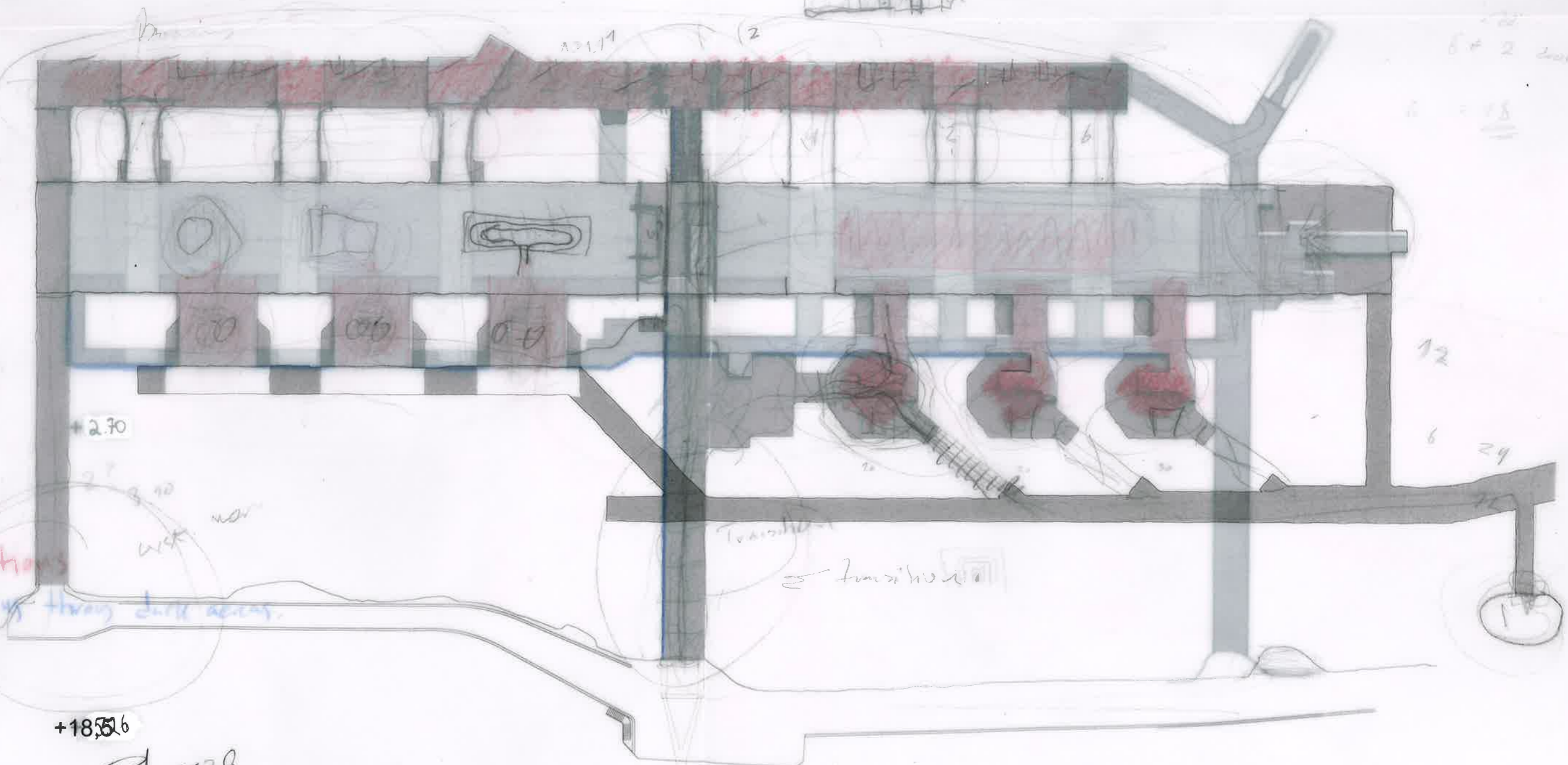

22  
 8 + 2 doors  
 6 = 18

- Functions  
 - Guiding through dark areas.

+18.56

For sand  
 For sand  
 sand

Transition  
 Transition

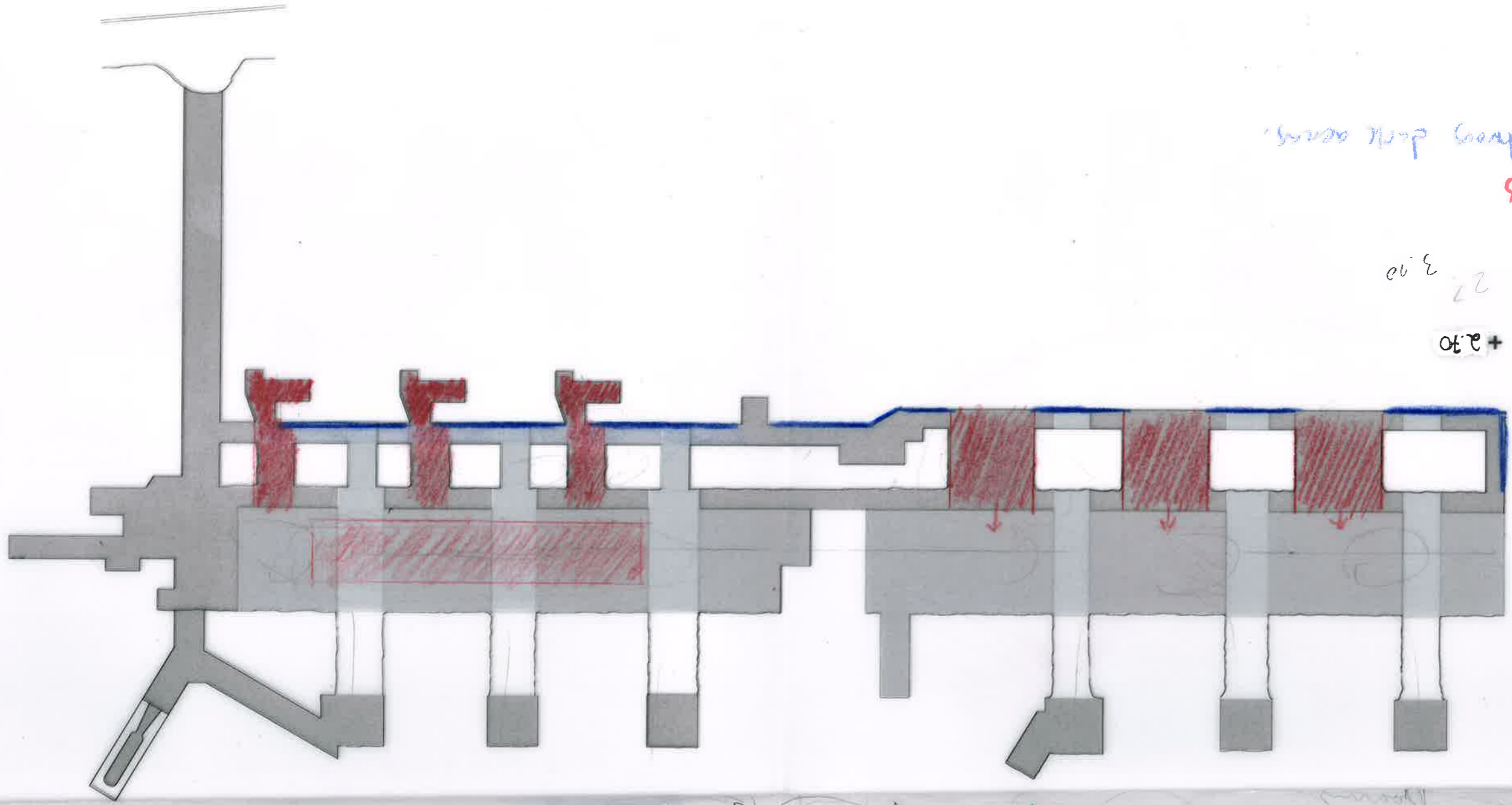

- Functions  
- Guiding through dark areas.

+ 2.30  
2'  
3.00

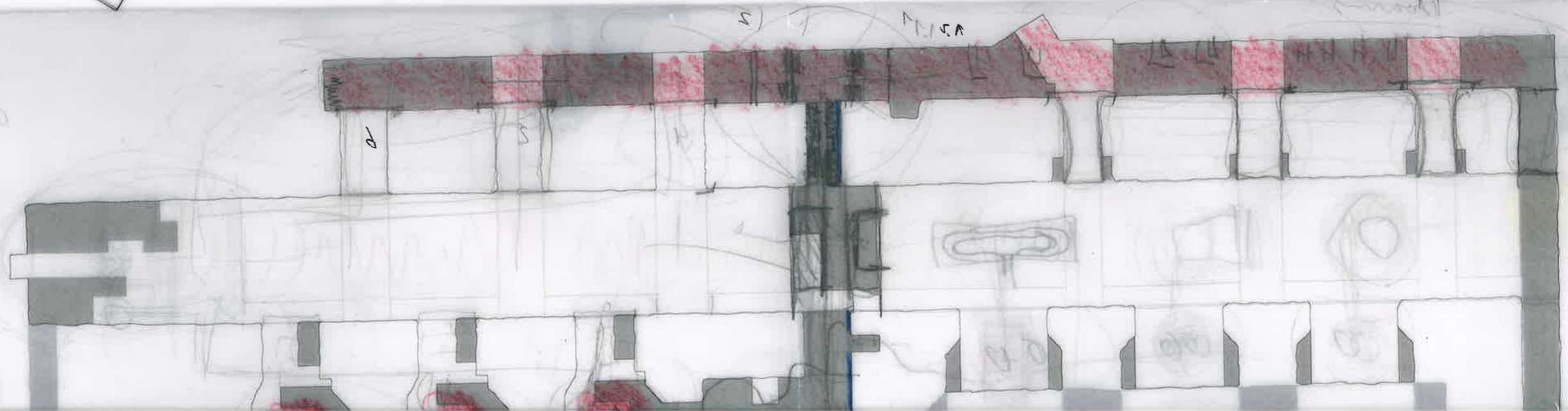

2 + 3 beam

2 = 1.8

4.5

5.663

+5.26

= Functions

- Guiding floor areas

+2.30

3.90

2

Transition

30

20

20

76  
24  
6  
12

6 = 28  
6 # 2 down  
12

9

2

4

2  
22111

Rooming

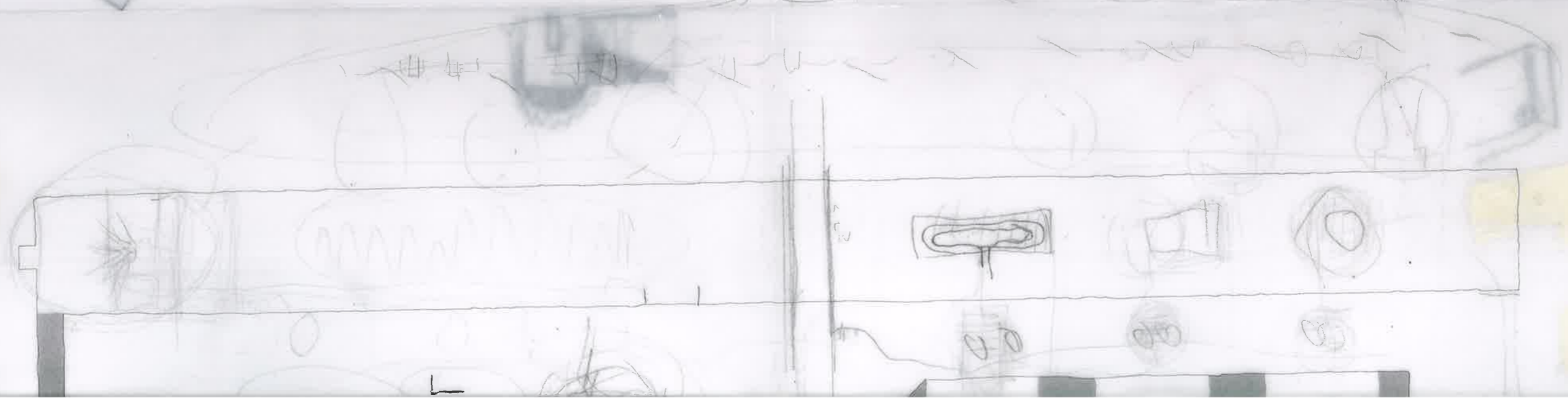
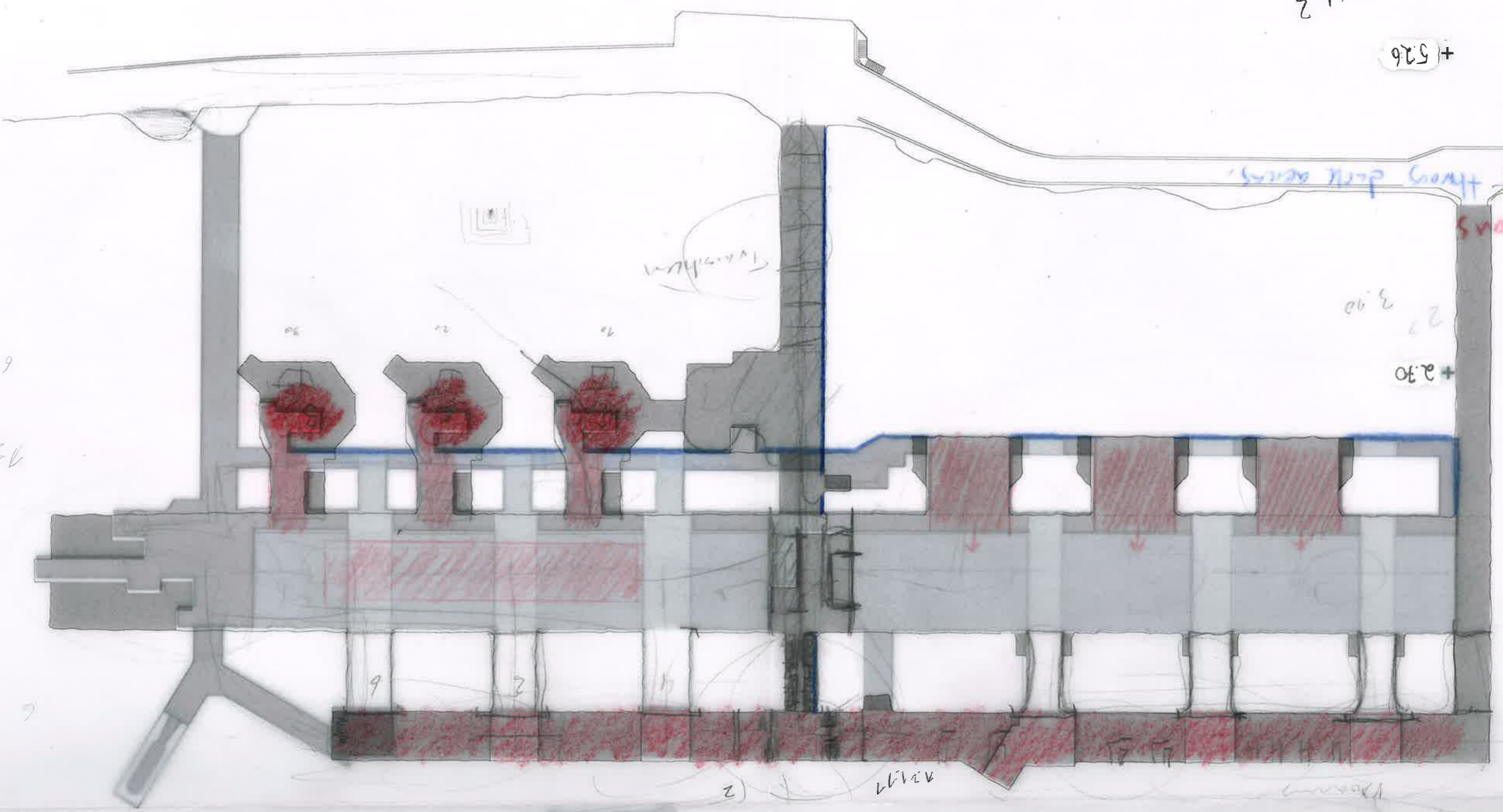

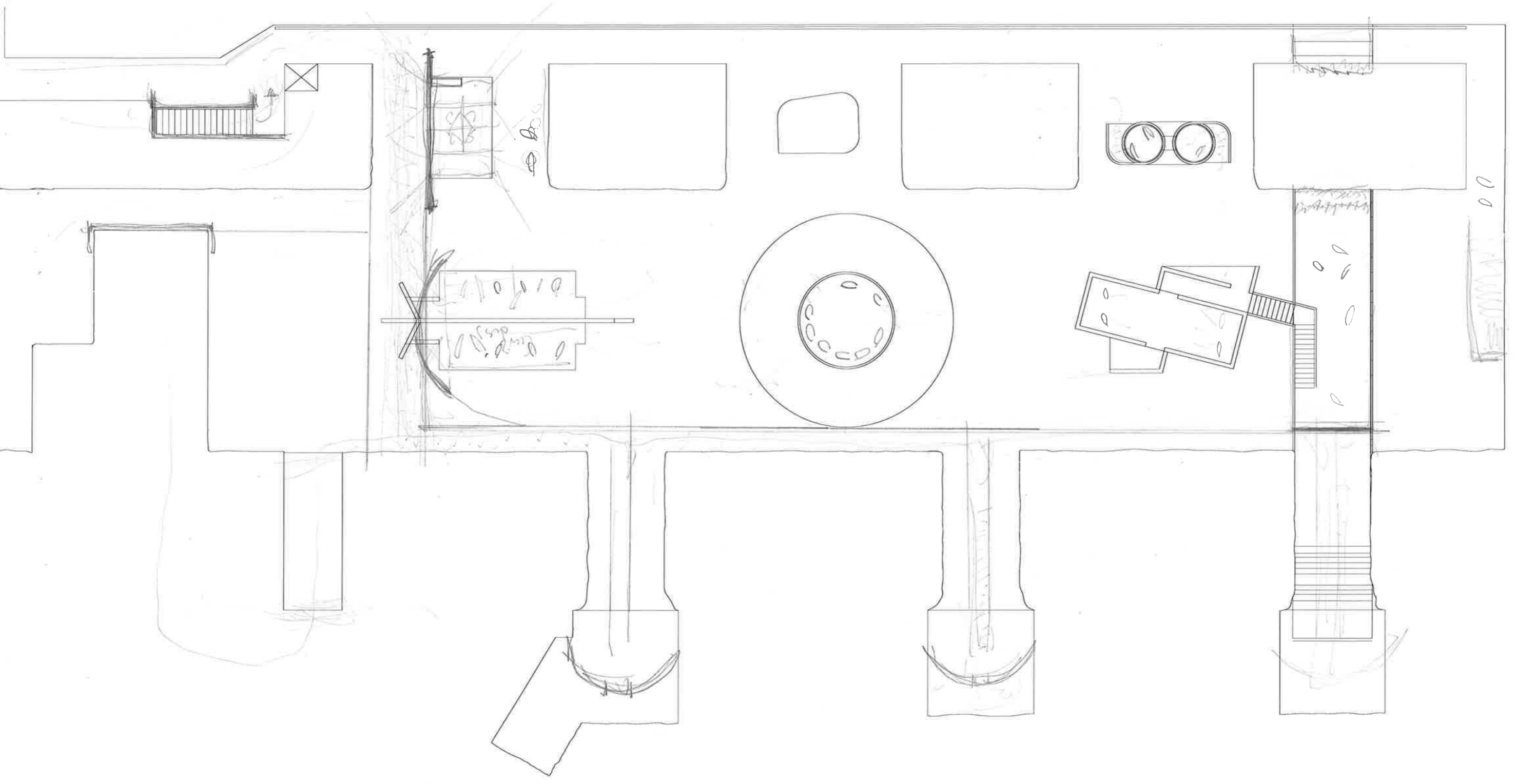
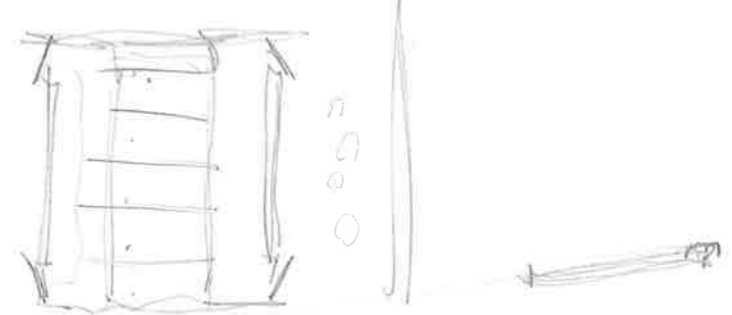

Alushu

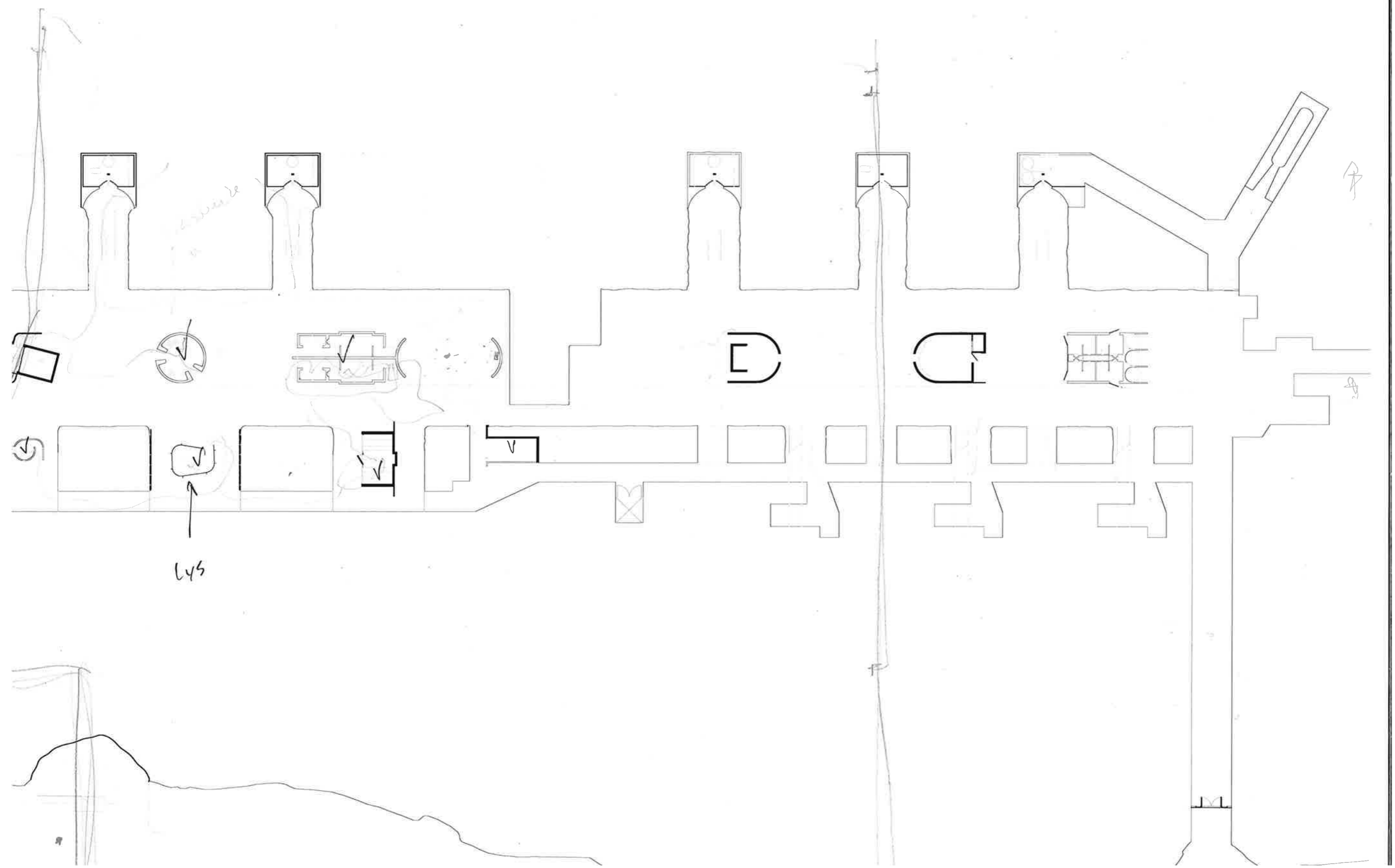

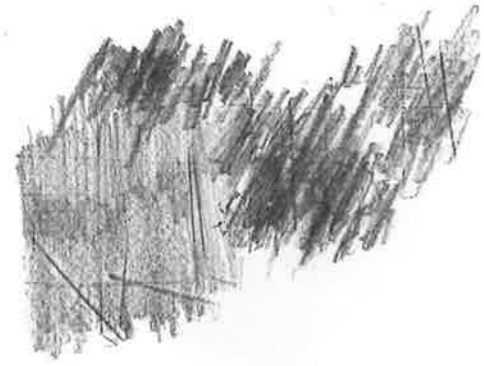

Gyar 2023  
plan + slikt

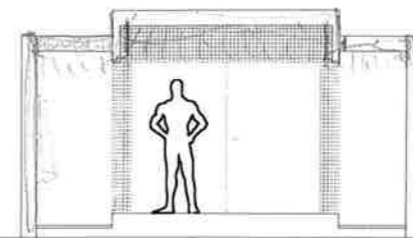
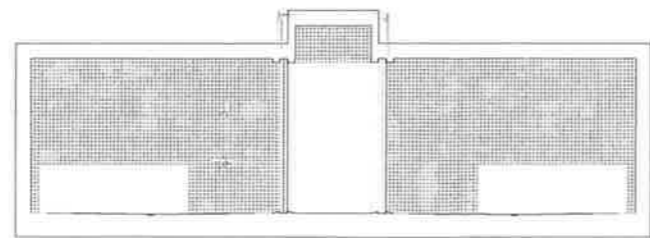
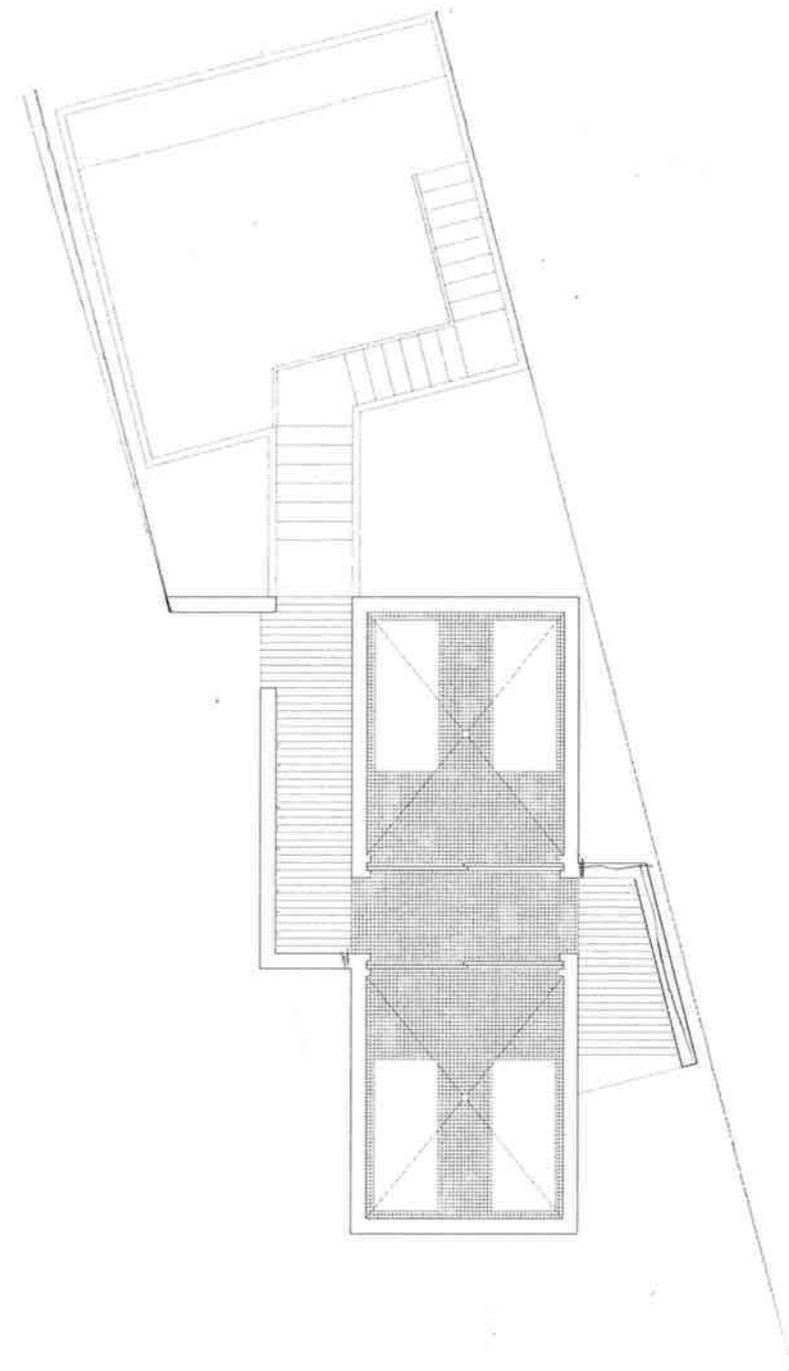
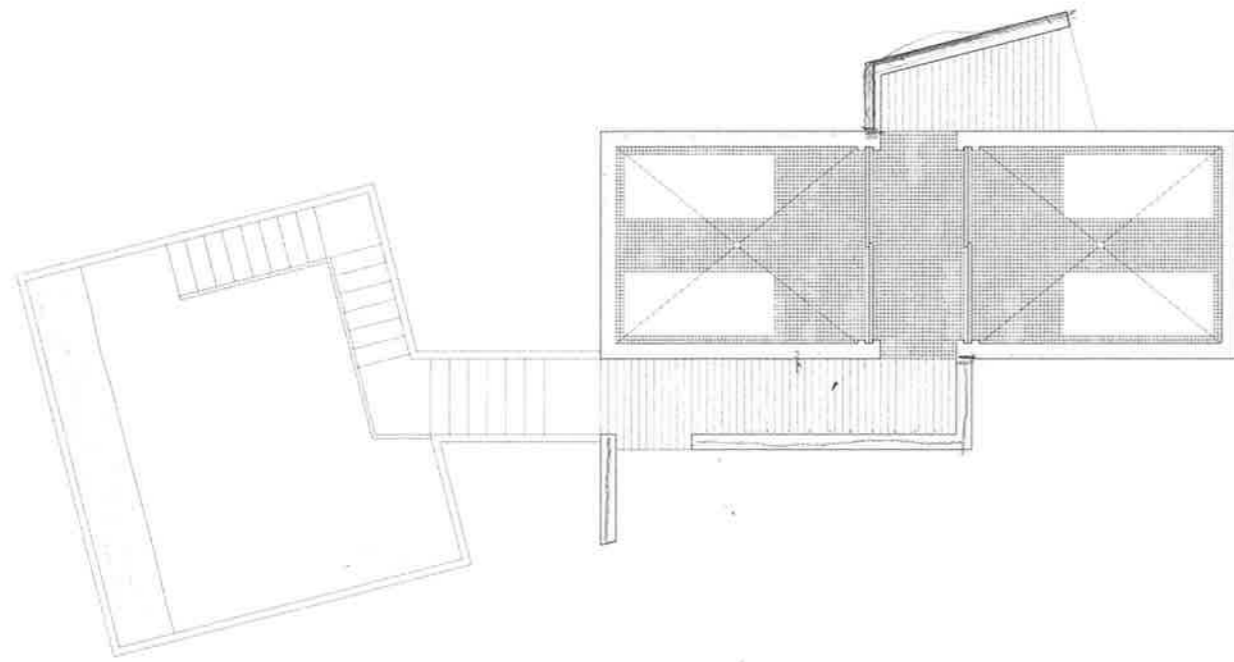

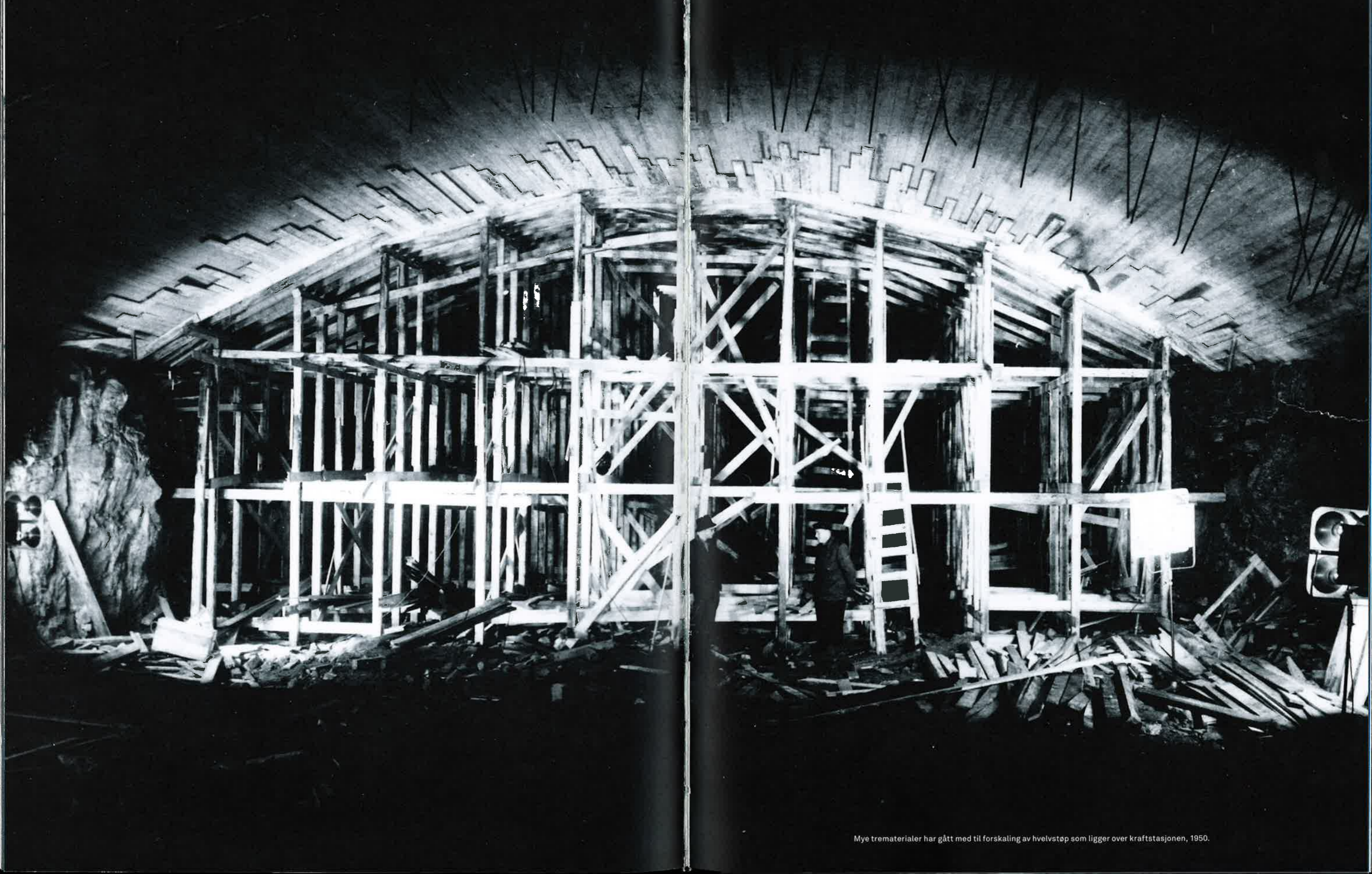

Mye trematerialer har gått med til forskaling av hvelvstøp som ligger over kraftstasjonen, 1950.

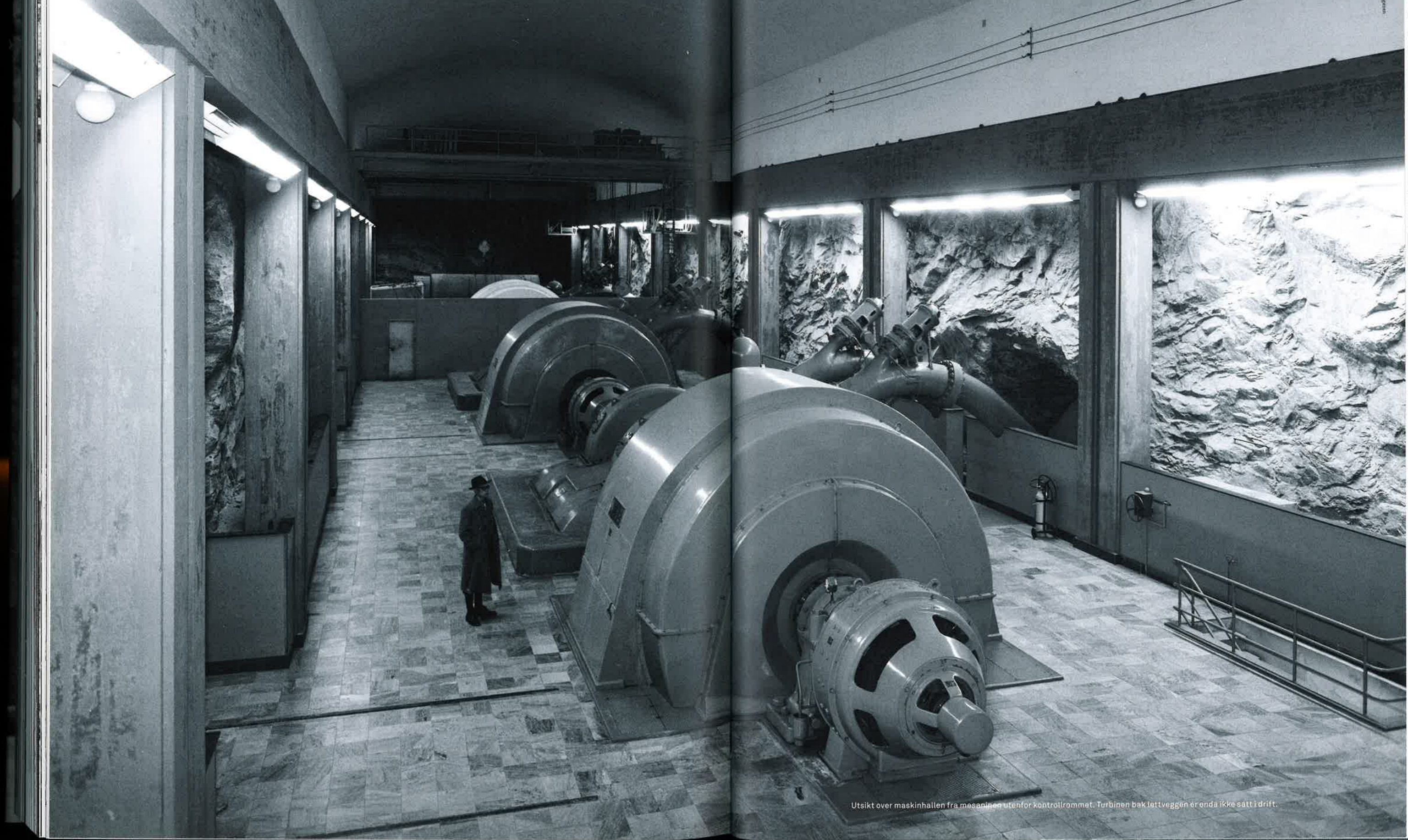

Utsikt over maskinhallen fra mesanjonen utenfor kontrollrommet. Turbinen bak lettvegg er enda ikke satt i drift.





Riktig verktøy er halve jobben,



Oversiktsbilde fra Lysebotn rundt 1950.



Disse to husene ble demontert og flyttet fra Åna-Sira og satt opp igjen i Lysebotn.

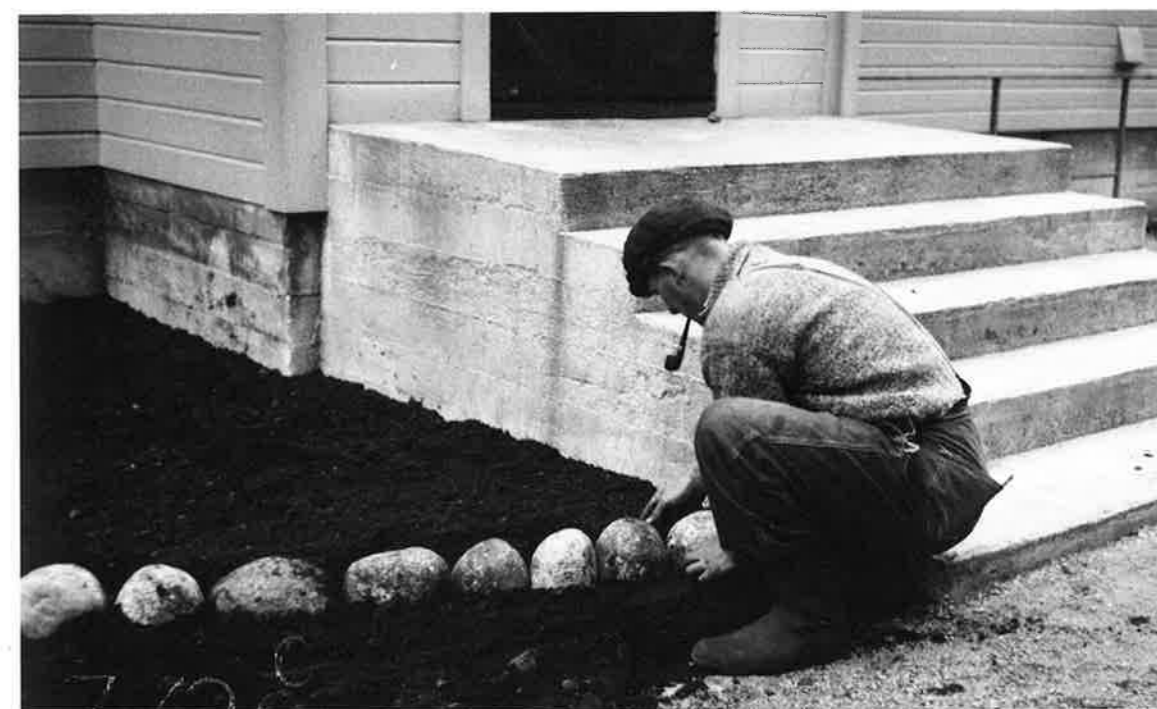

Pent skal det være. Blomsterbed ble anlagt for å gjøre det fint rundt husene, våren 1950.



42 A



Håndlasting av trekkevogn, tidlig i 1950.





Barnesikring anno 1951.



Arbeiderne i Lysebotn flyttet hit med familiene sine.

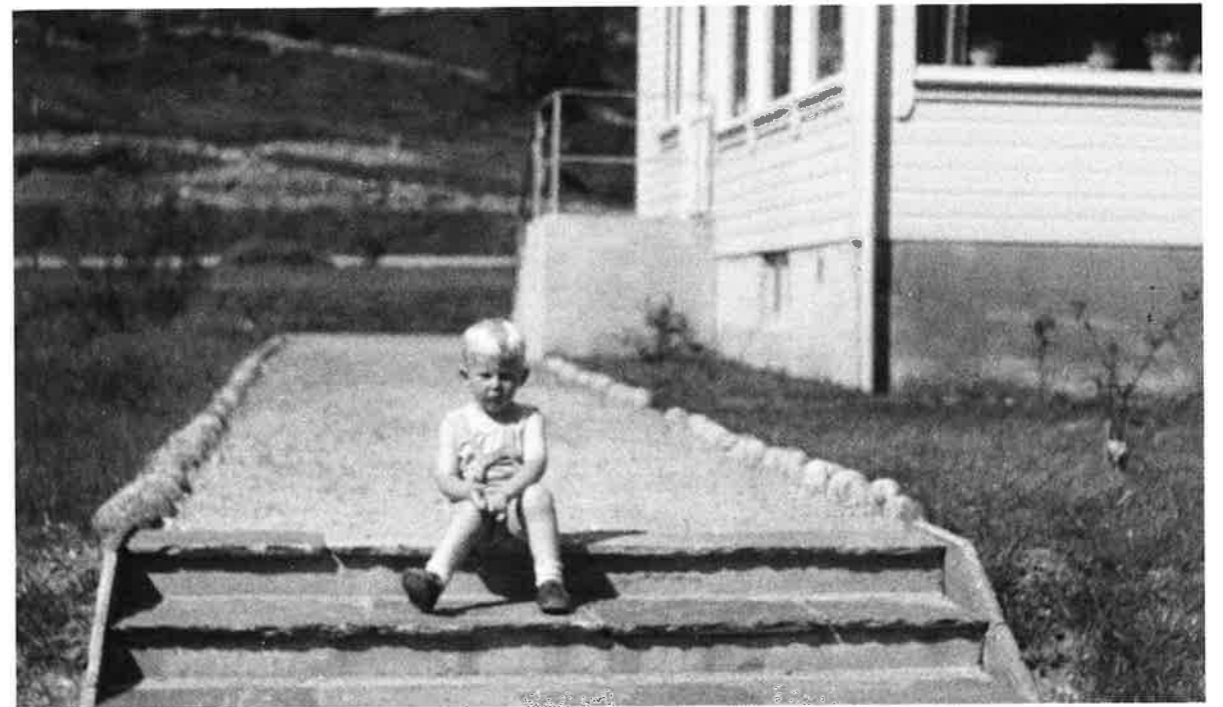

Messa er gjort fin med hagegang og trapp.



Det ble etablert egen skole for barna i Lysebotn.

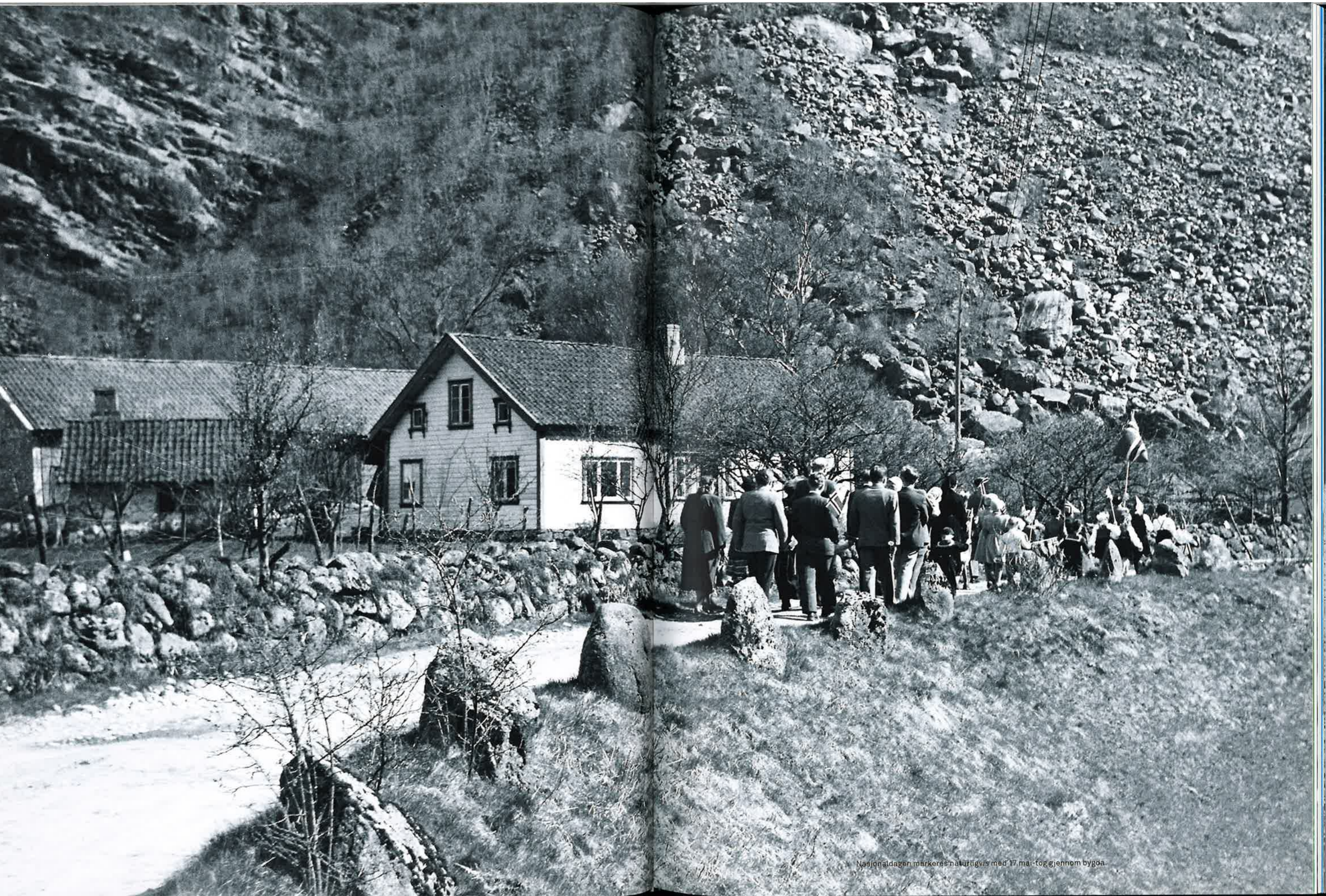

Nasjonaldagen markeres naturligvis med 17. mai-tog gjennom bygda.



## Natur.

Lysefjorden ble formet av breene under istida. Under isen lå grus og stein som gled fram sammen med isen og slipte grunnen under. Enkelte steder ble det gravd ut store renner. Lysefjorden er en slik renne.

I tillegg til å være en mektig naturopplevelse er Lysebotn et ideelt sted for kraftproduksjon. Små avstander mellom høyfjell og lavland gir korte overføringsveier for vannet og er et meget godt utgangspunkt for å etablere vannkraftproduksjon.



Flerli sitt lag står oppstilt før fotballkampen mellom Flerli og Lysebotn i 1948. Resultatet er ikke notert.



Om vinteren er solen borte fra Lysebotn i fire måneder.



Det blir mange bekker av regnet i heiane rundt Lysebotn.  
Høye fjell bidrar til at det regner dobbelt så mye i Lysebotn som i Stavanger.





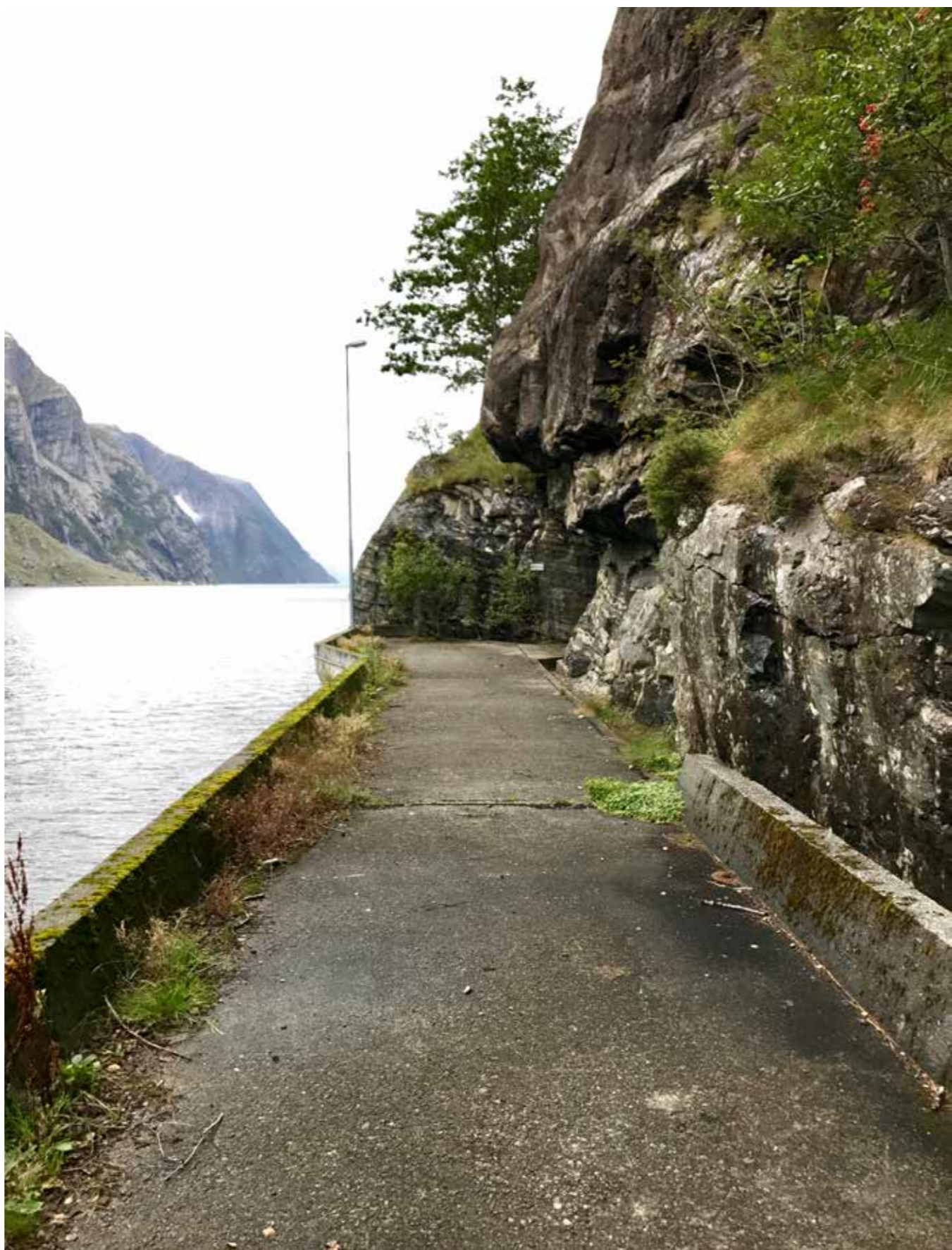



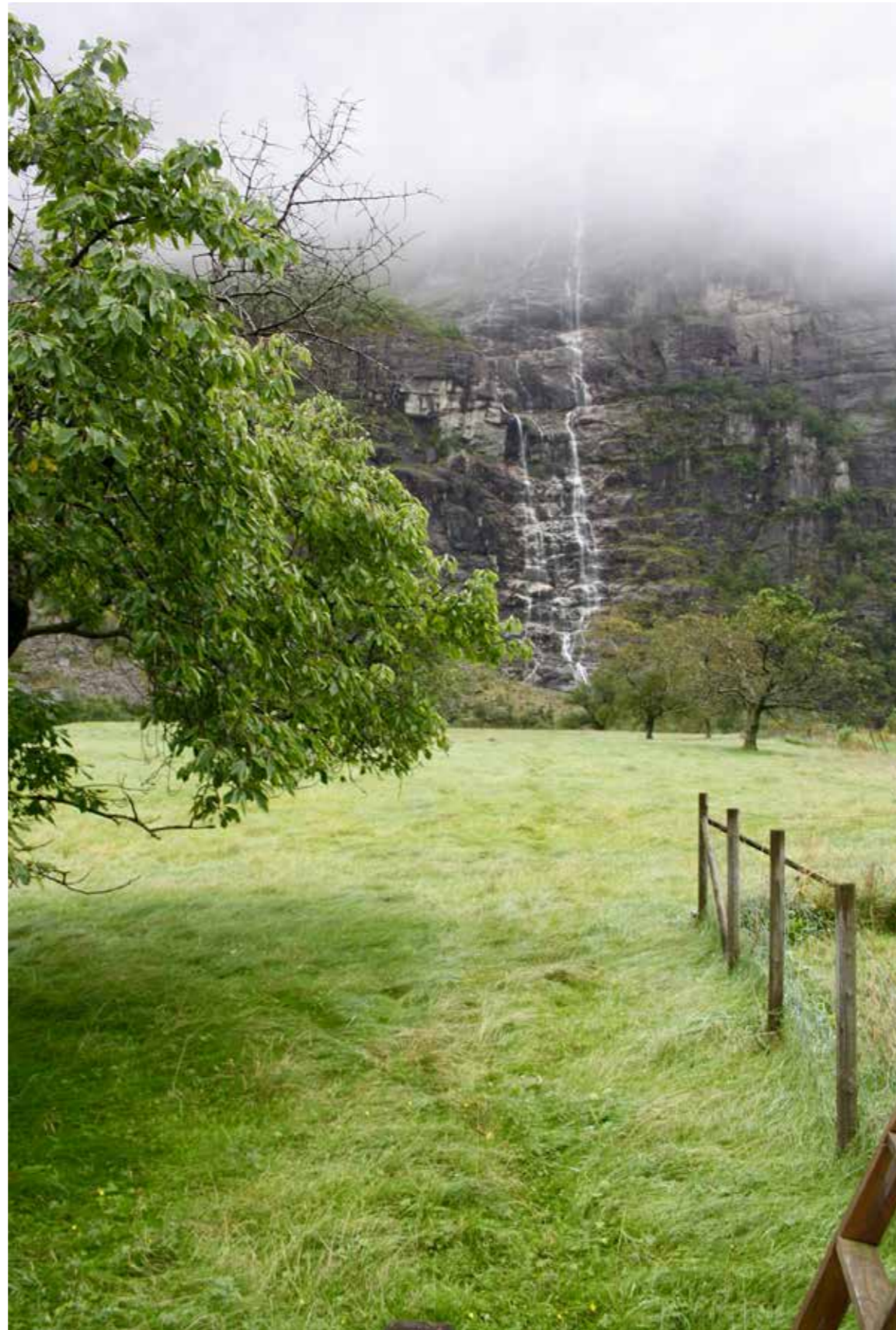





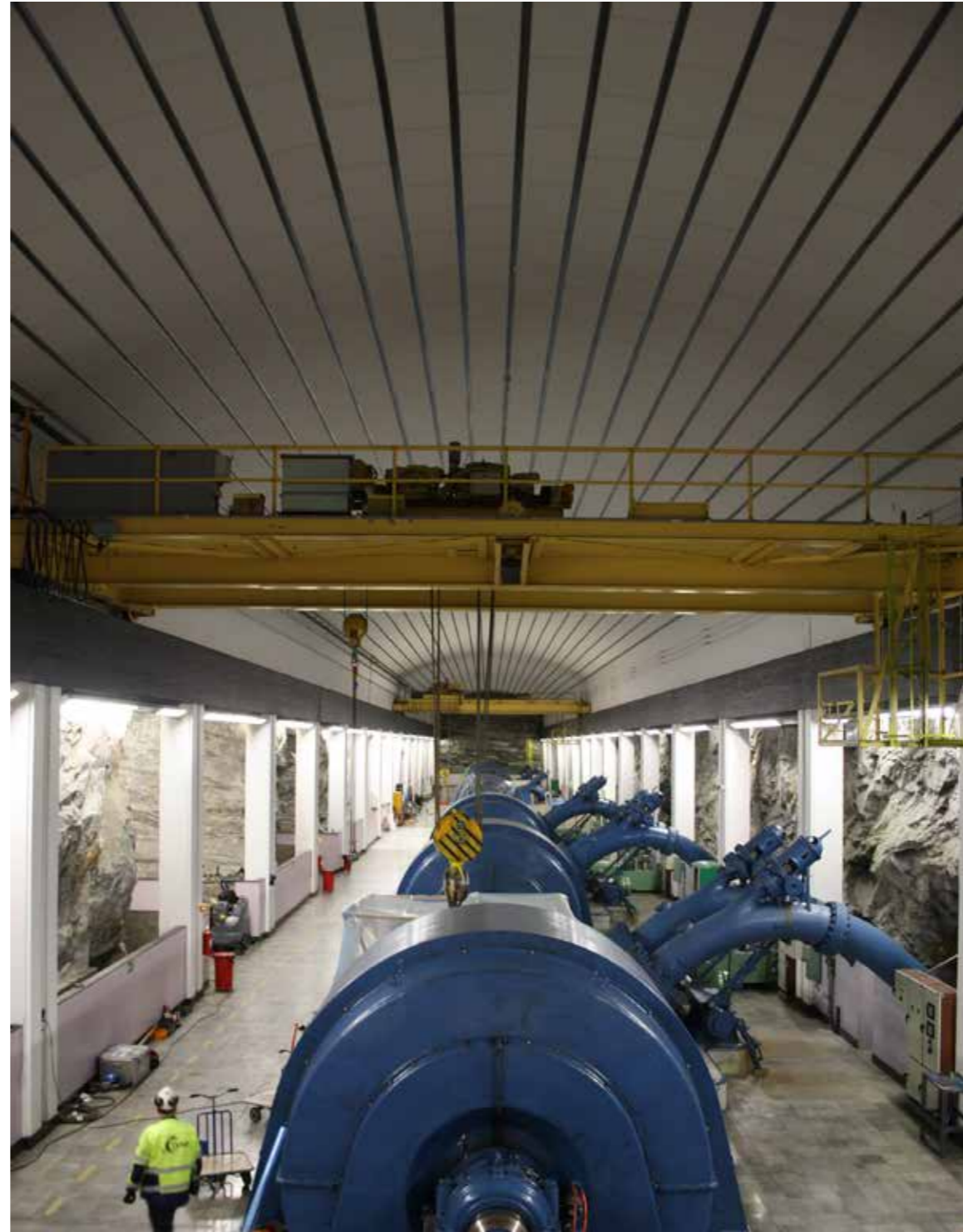









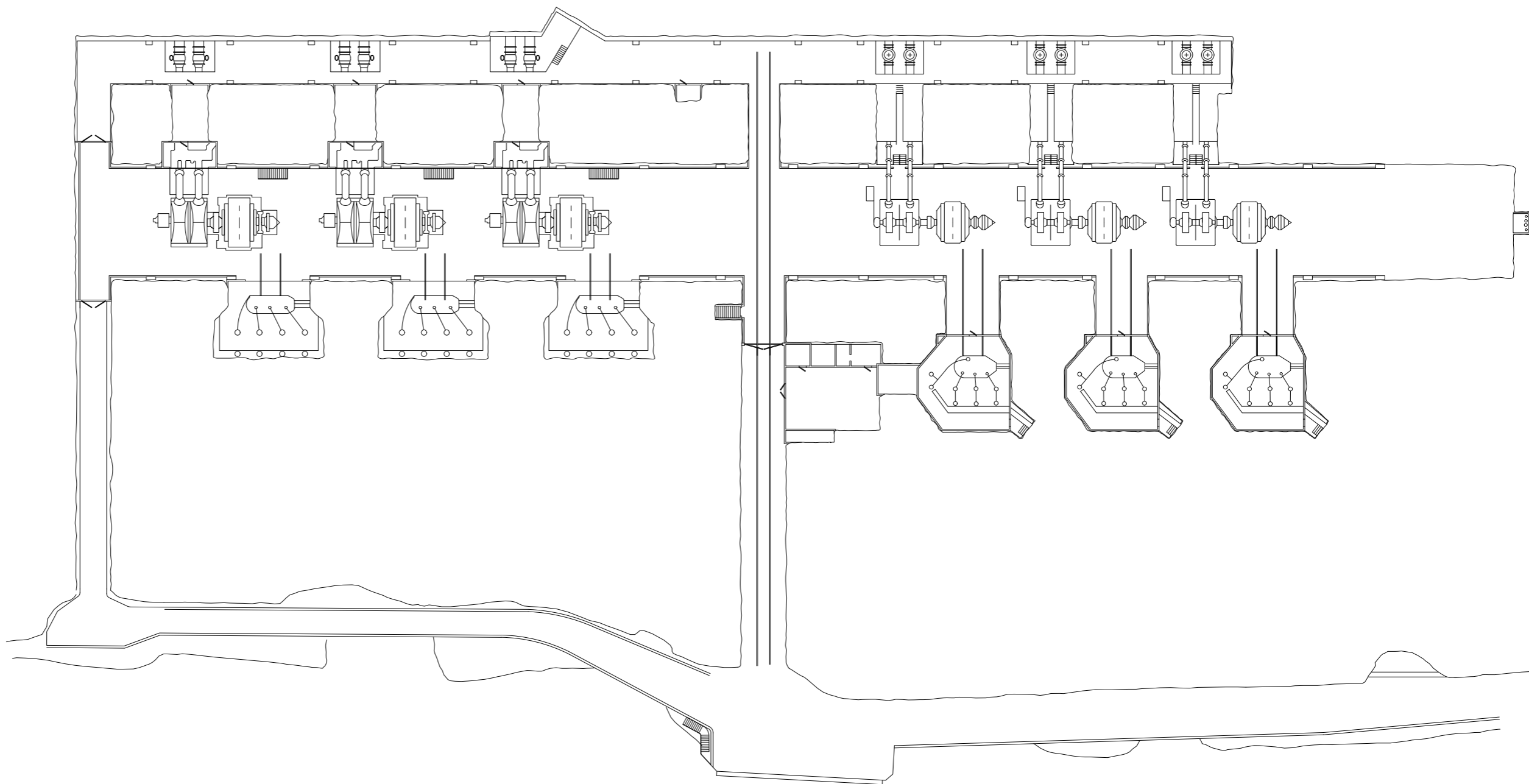
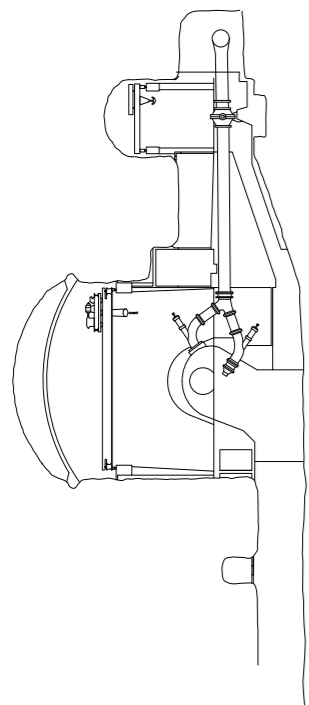



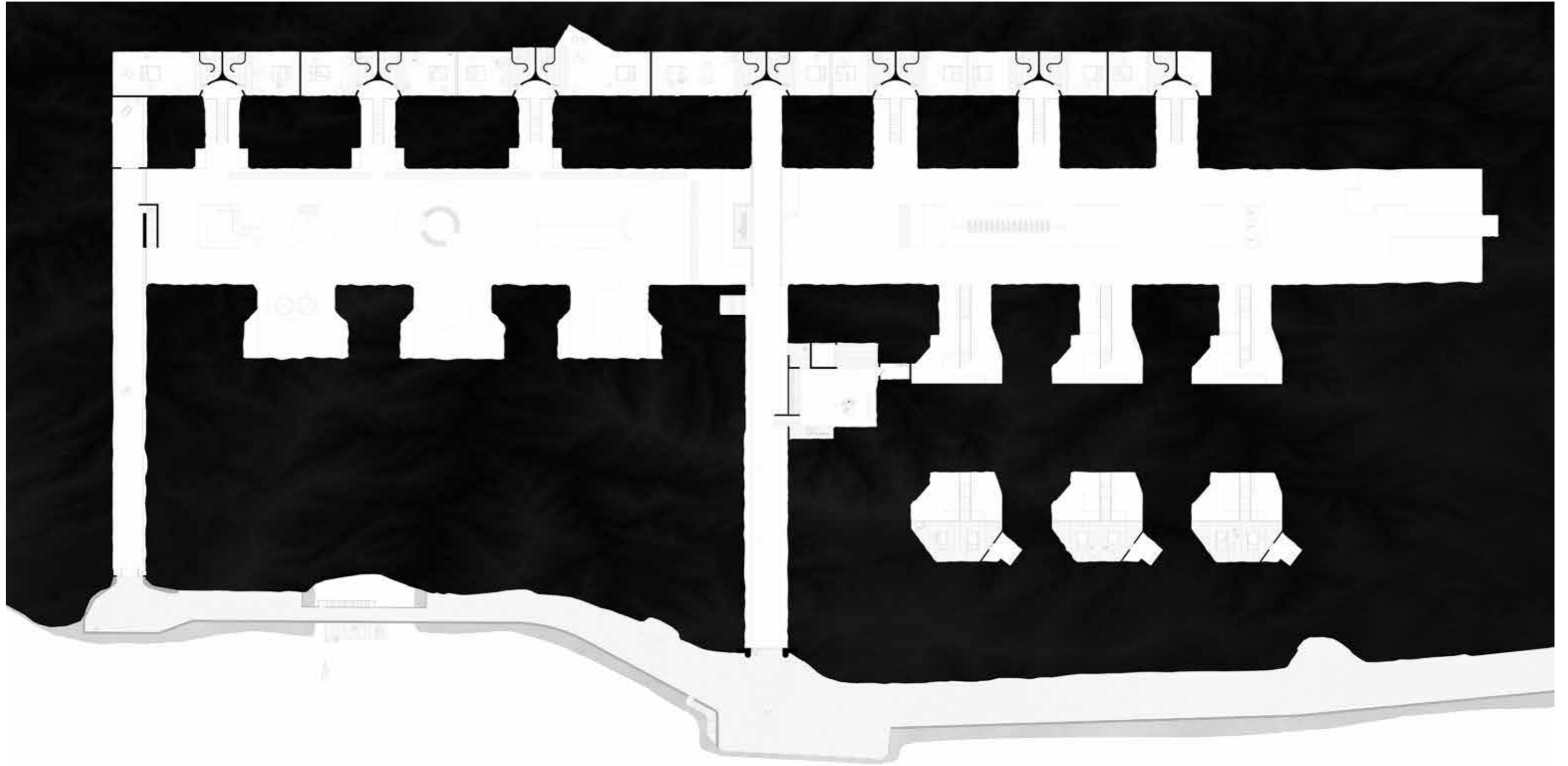

Plan 1, Main entrance





Rom for overnatting:

Dette rommet skal tilby turister muligheten til å overnatte ved/i den gamle fjellhallen til lysebtan 1 kraftanlegg. Rommet inneholder 5 senger, et lite kjøkken og et bad med dusj, vask og toalett. Alle sengeplassene er plassert i et åpent rom, organisert som en sovesal, og alle sengene har et eget skap hvor de besøkende kan oppbevare private gjenstander.

Rommets kvaliteter:

Dette rommet skal fungere som en kontrast til omgivelsene.

Mulige plasseringer:

- Inne i den gamle hallen, om alt utstyret tas ut.
- Ute langs fjellkanten.
- På innsiden av fjellveggen.
- Ute i vannet.

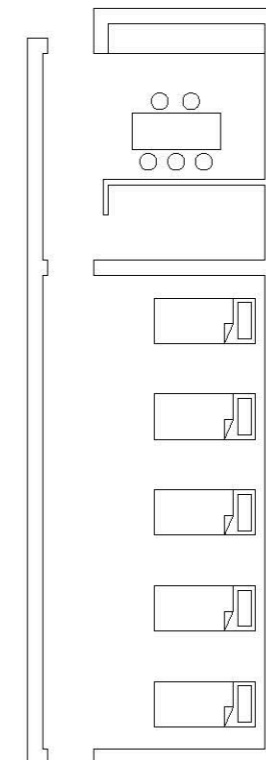





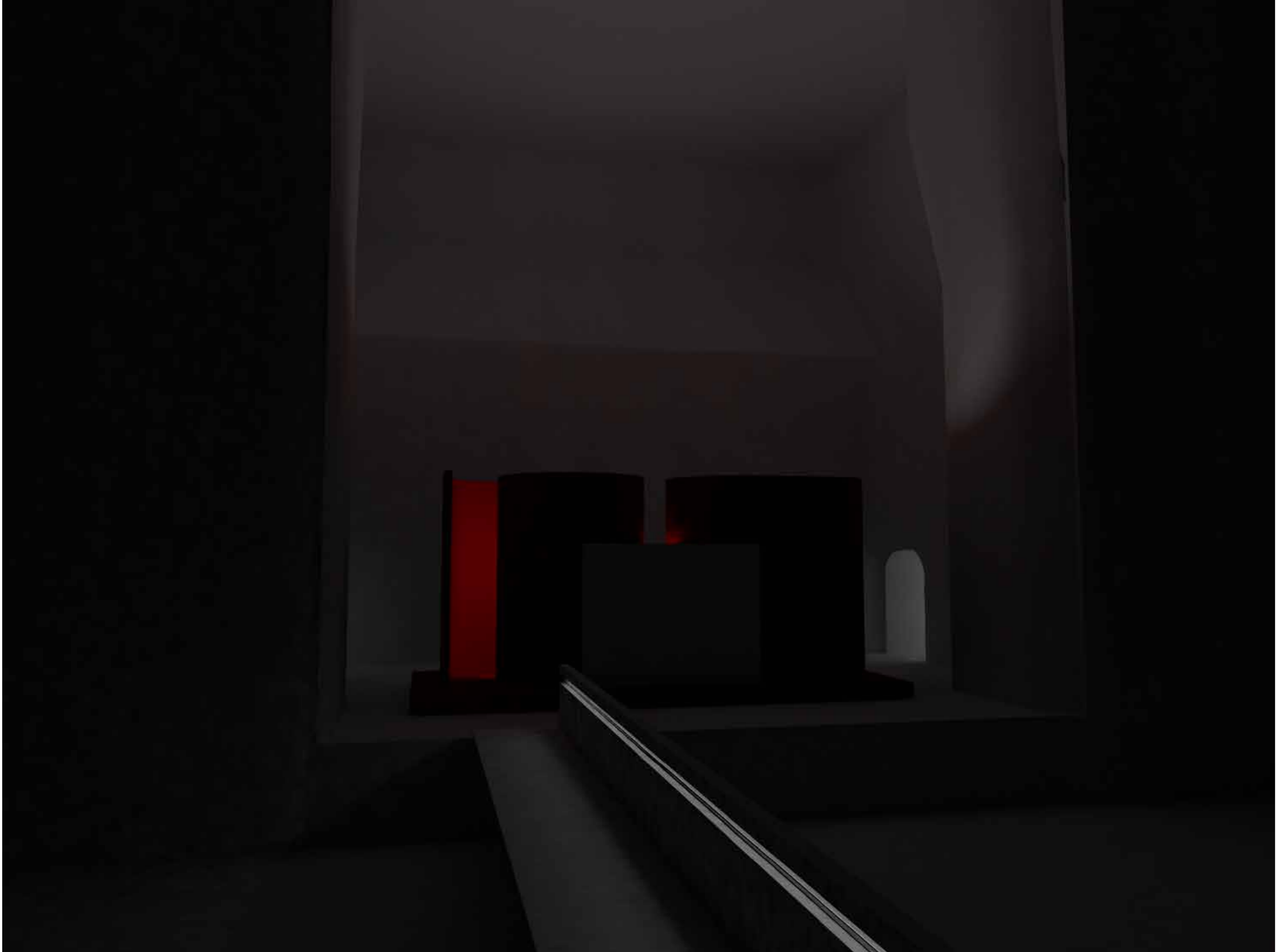

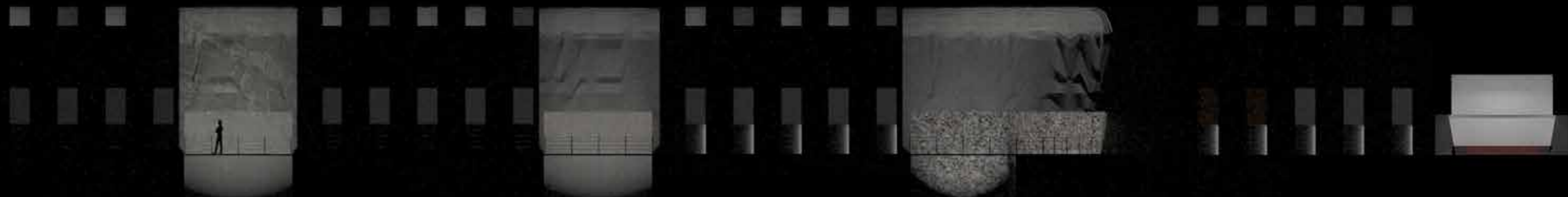



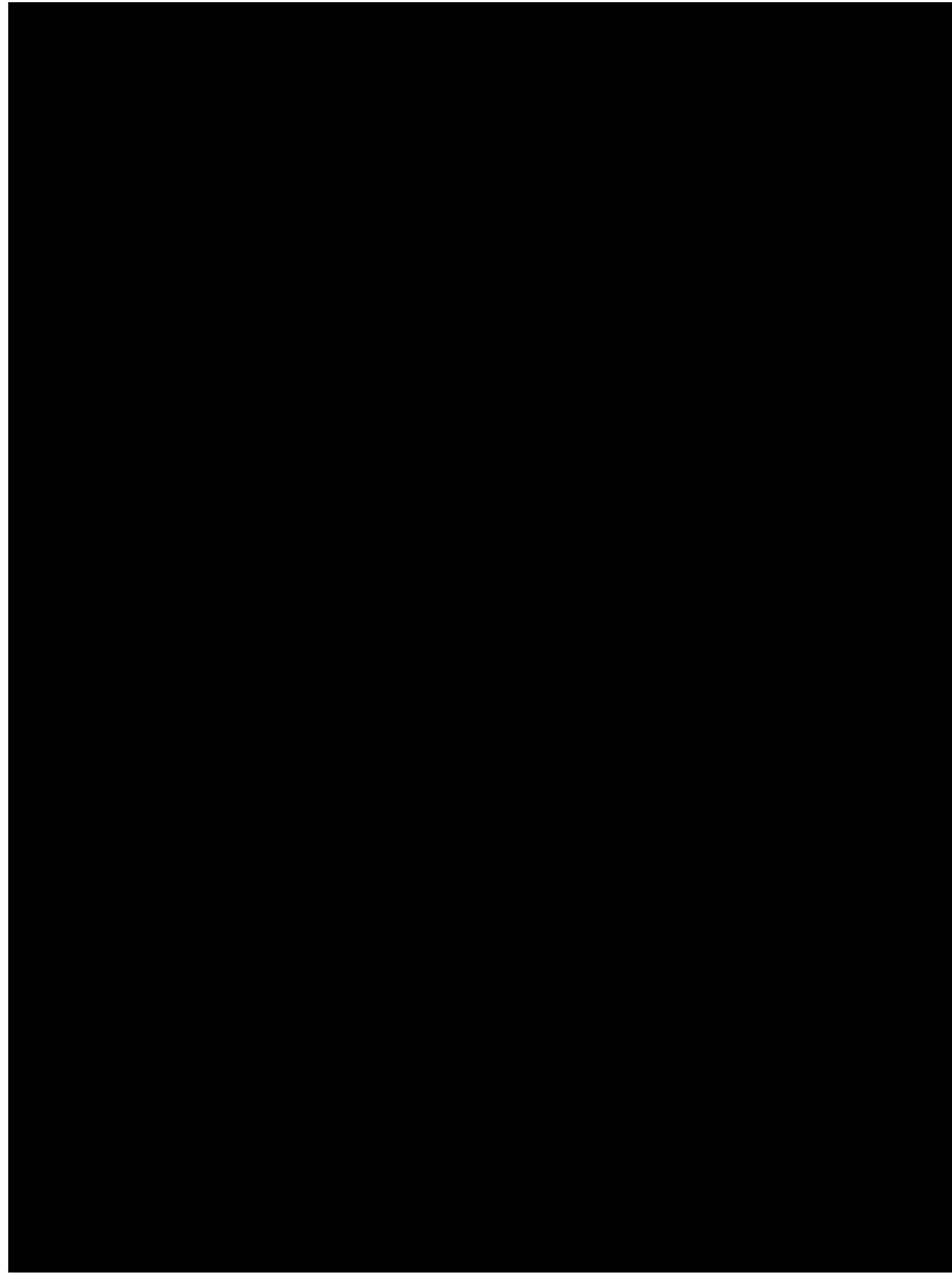

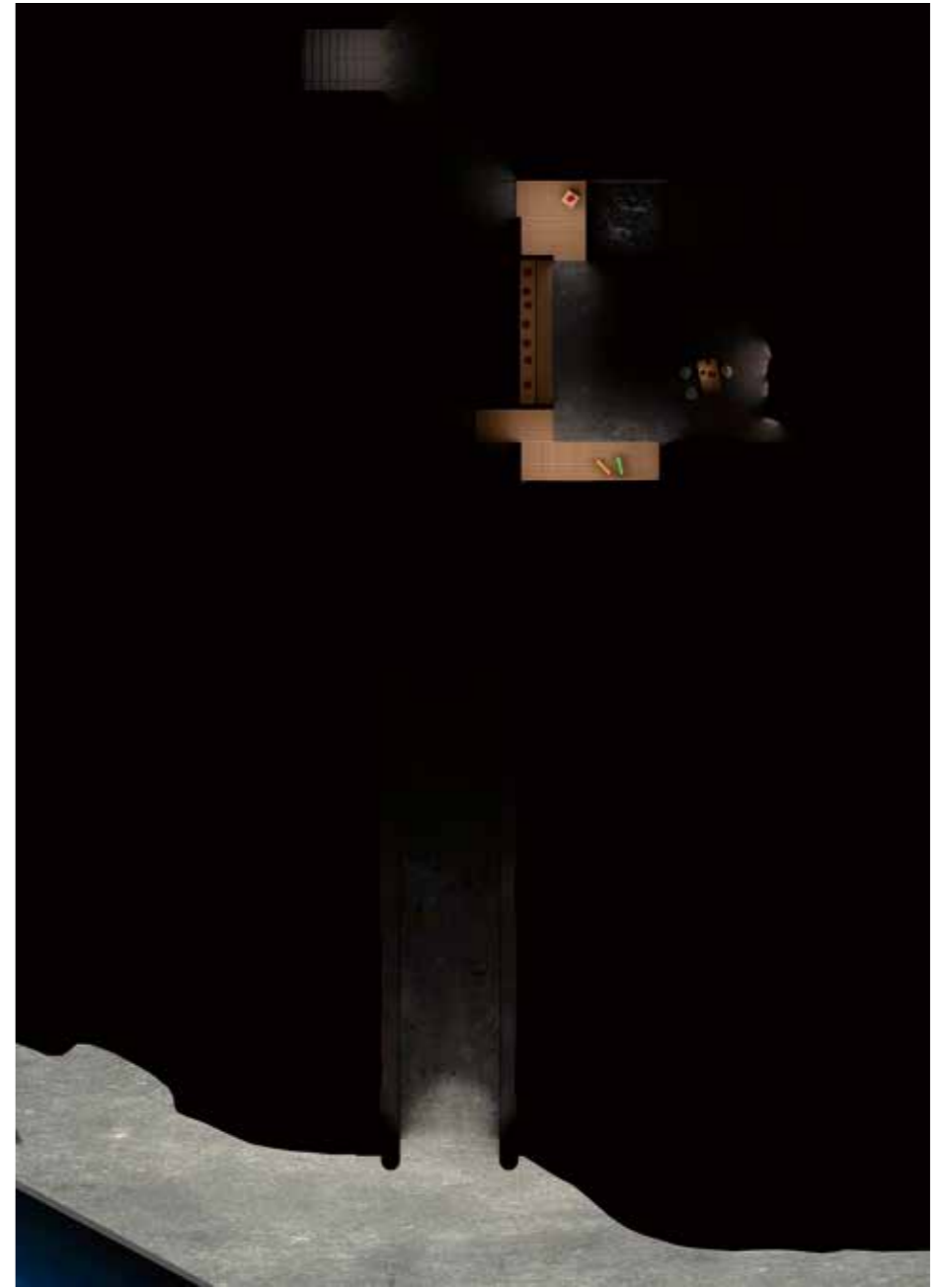
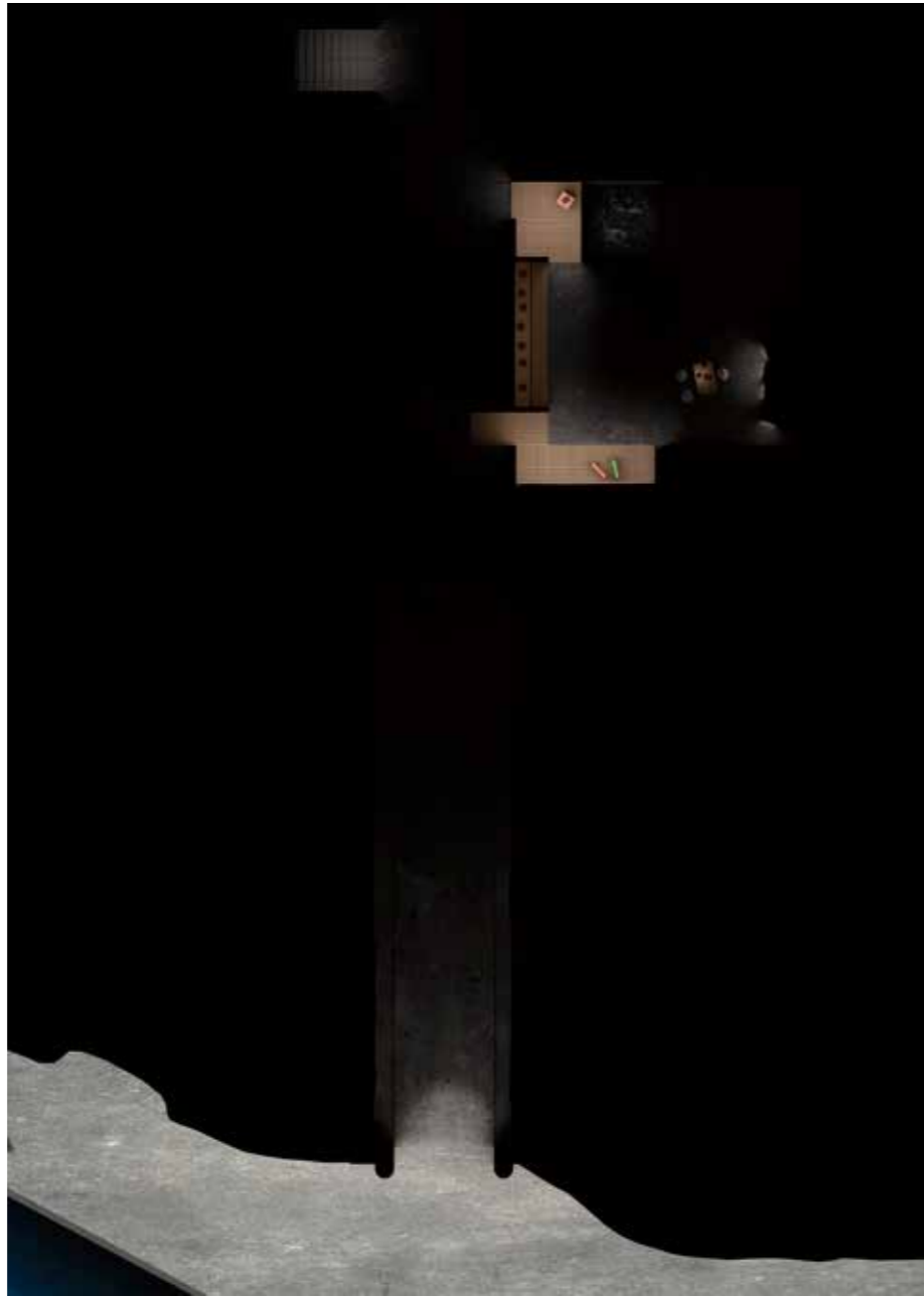

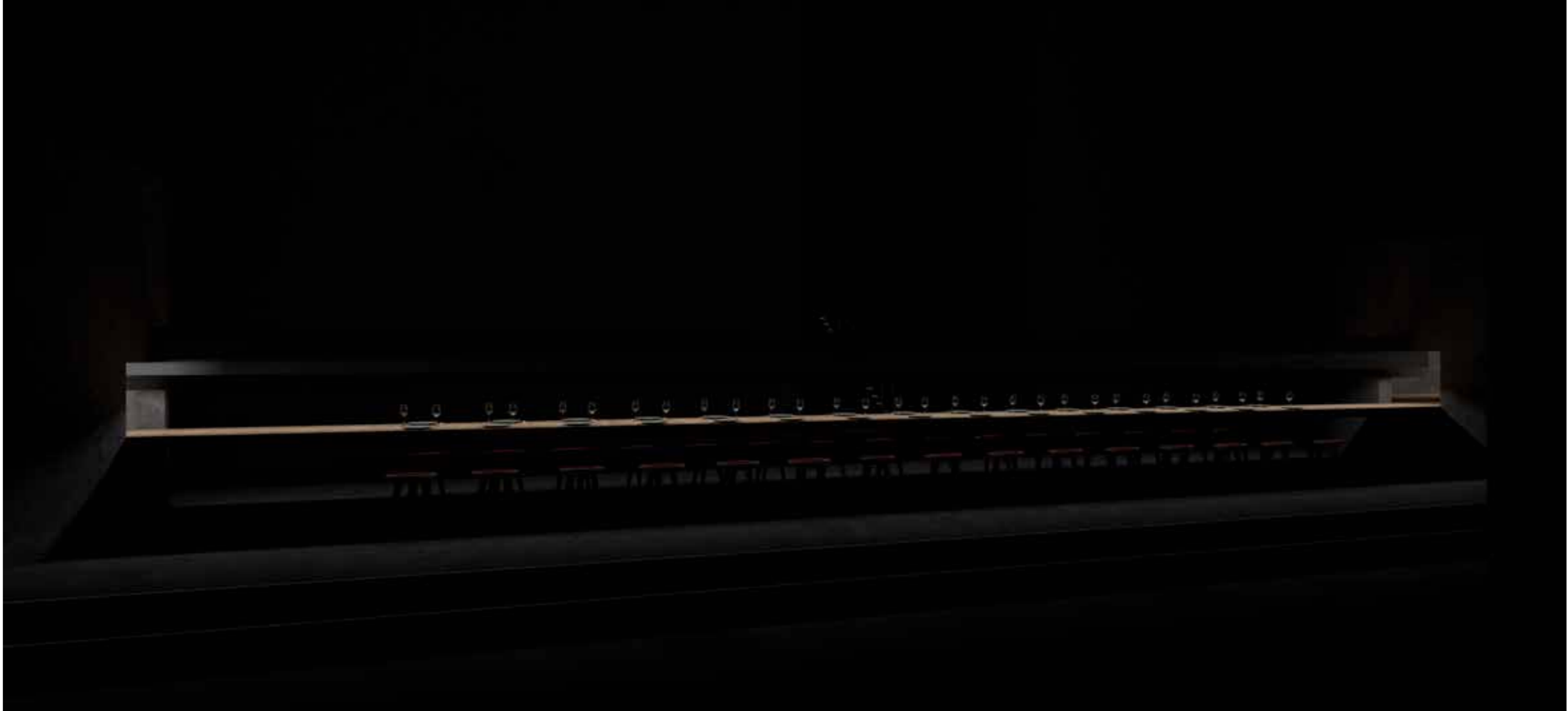





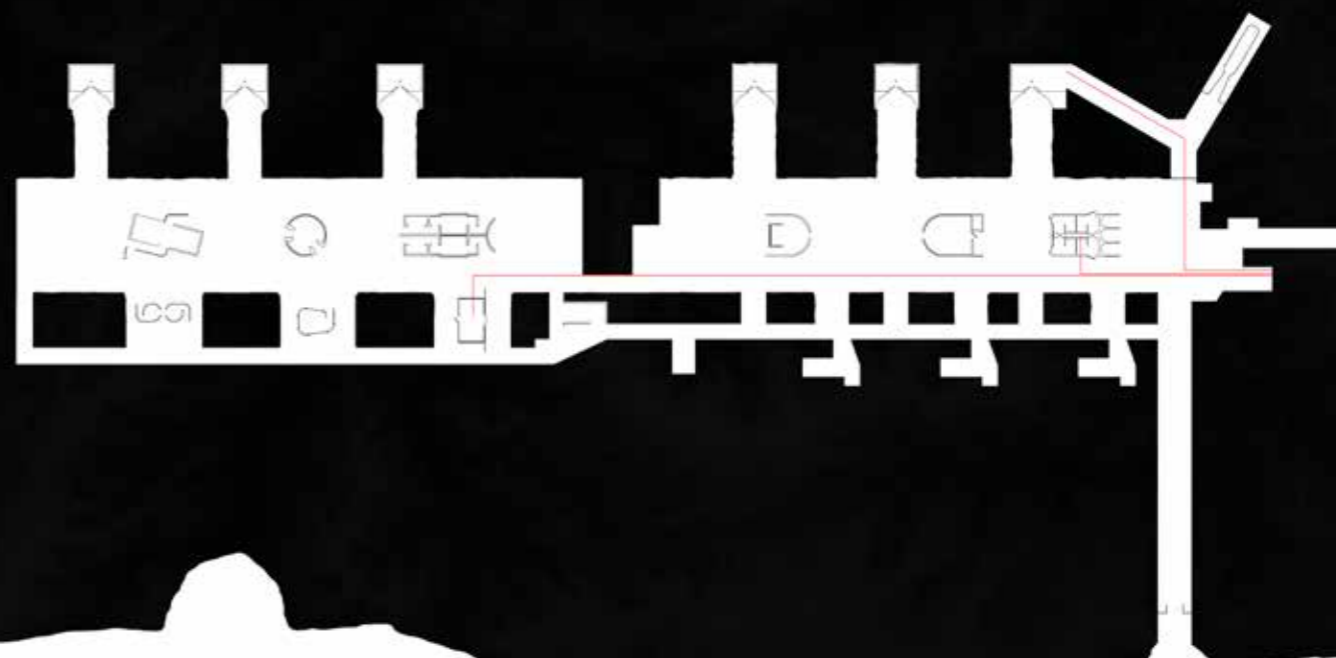
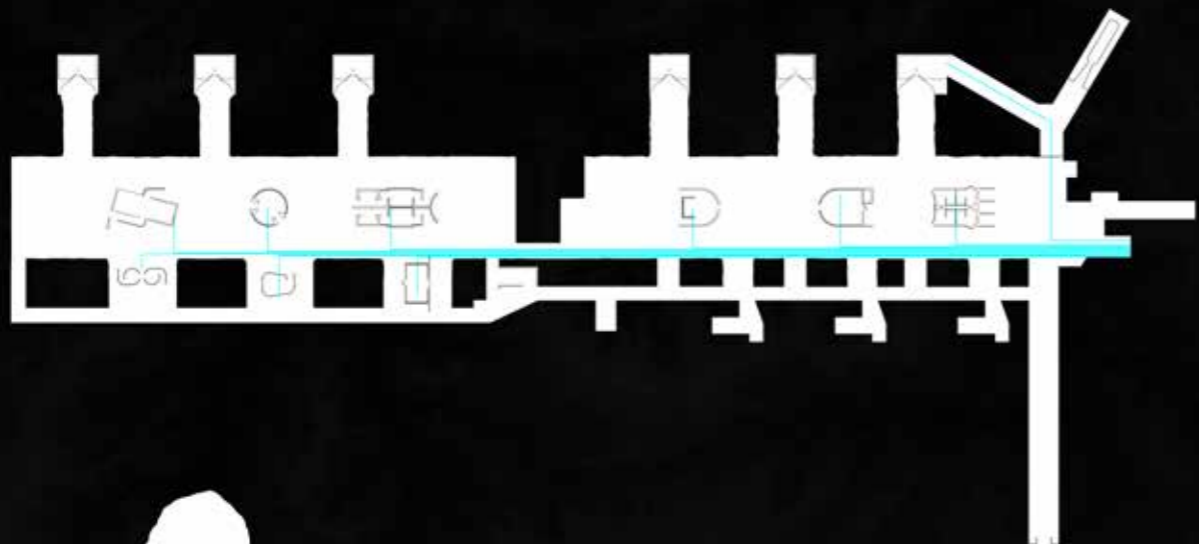

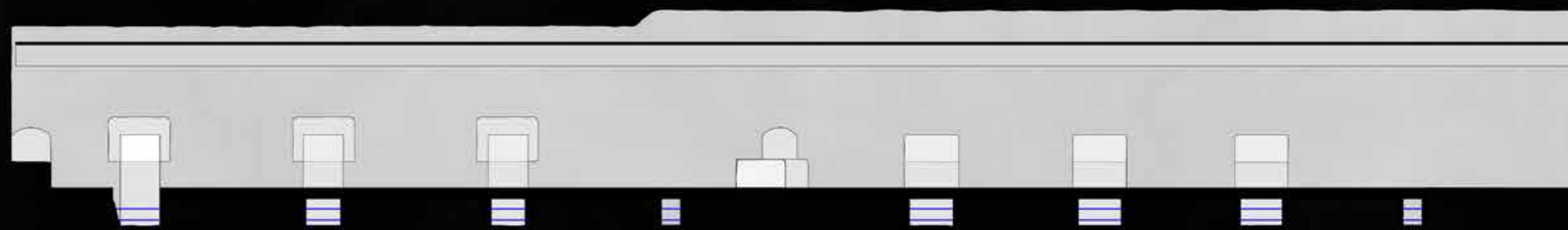

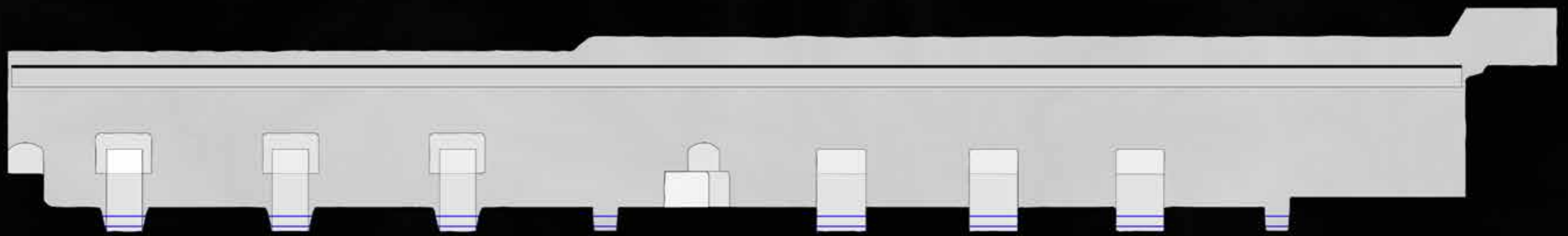

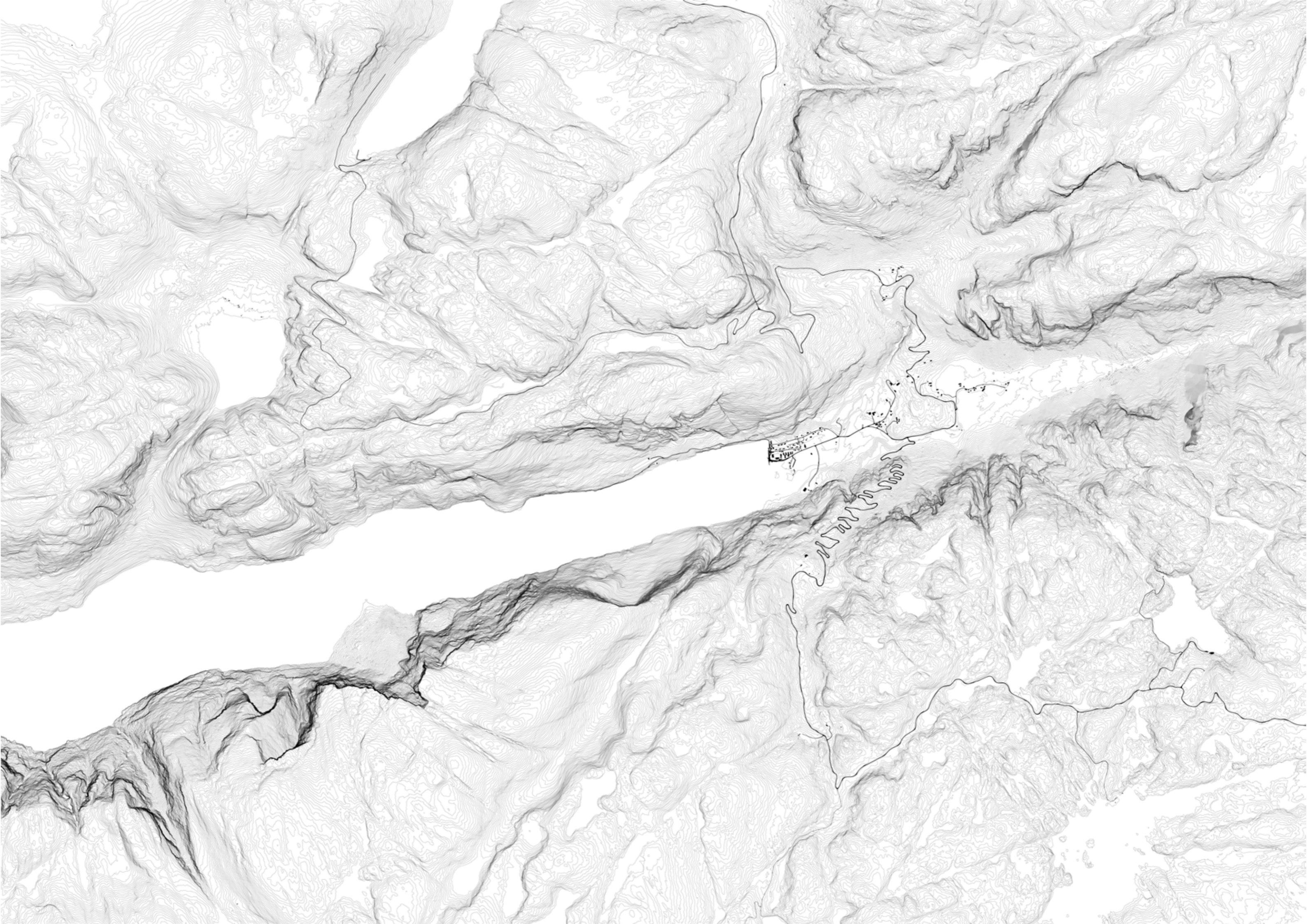

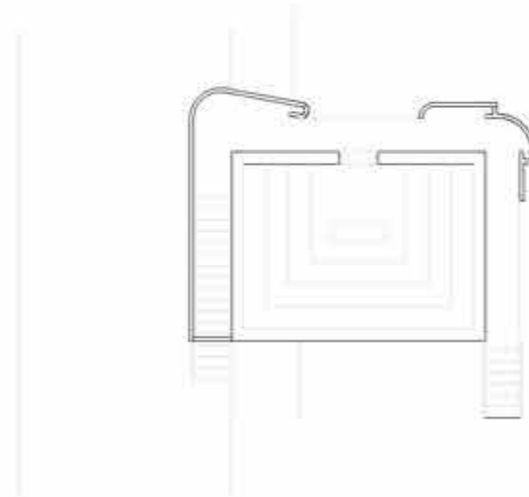
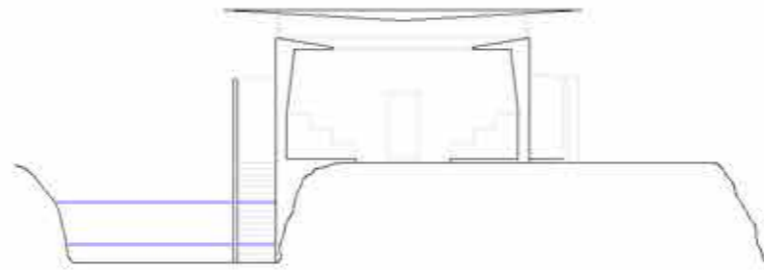
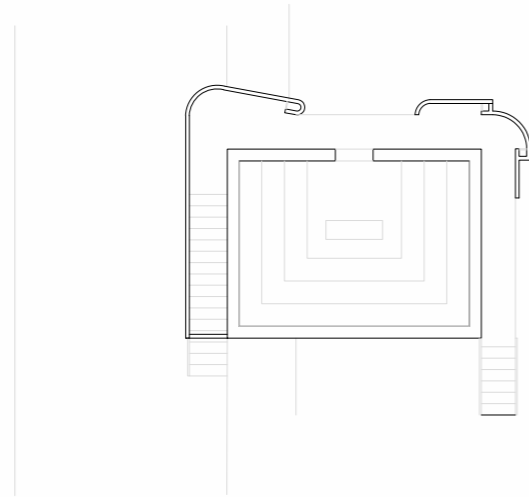
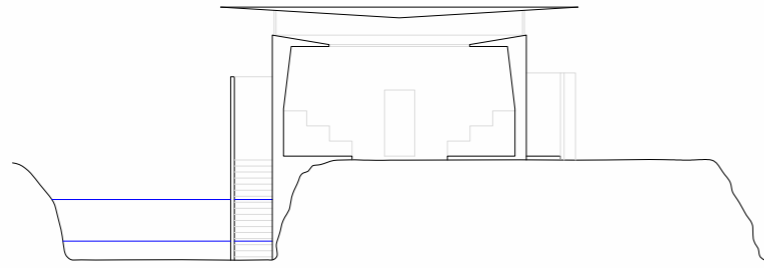

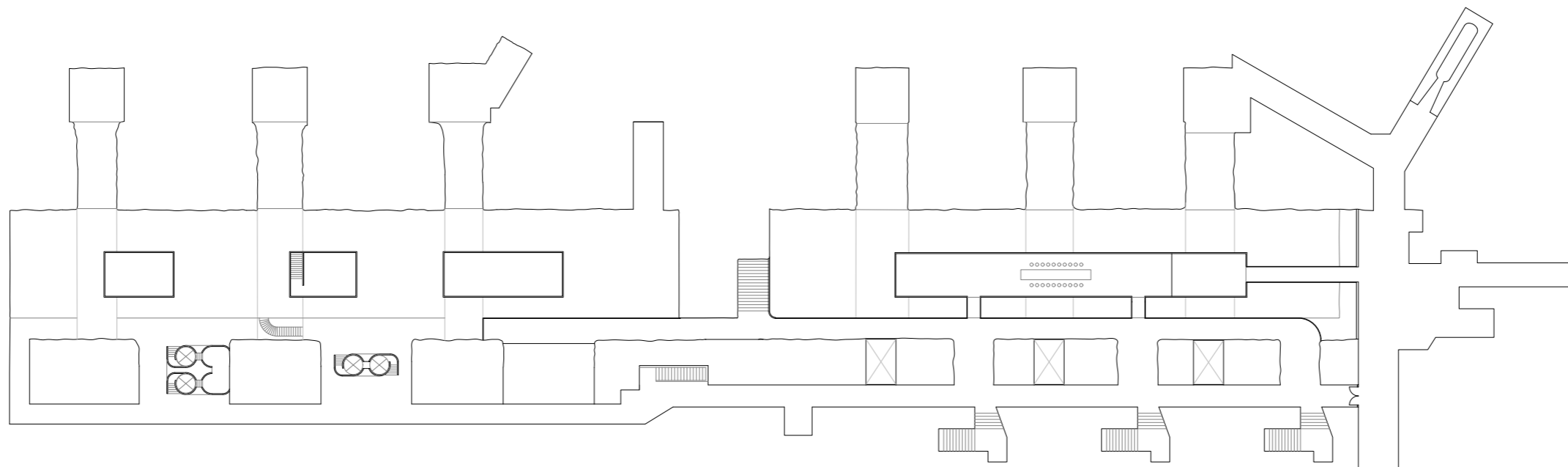

+2.70

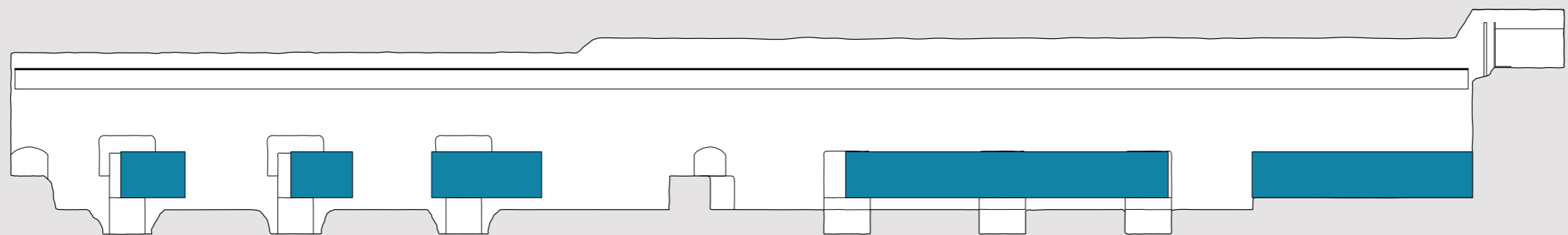

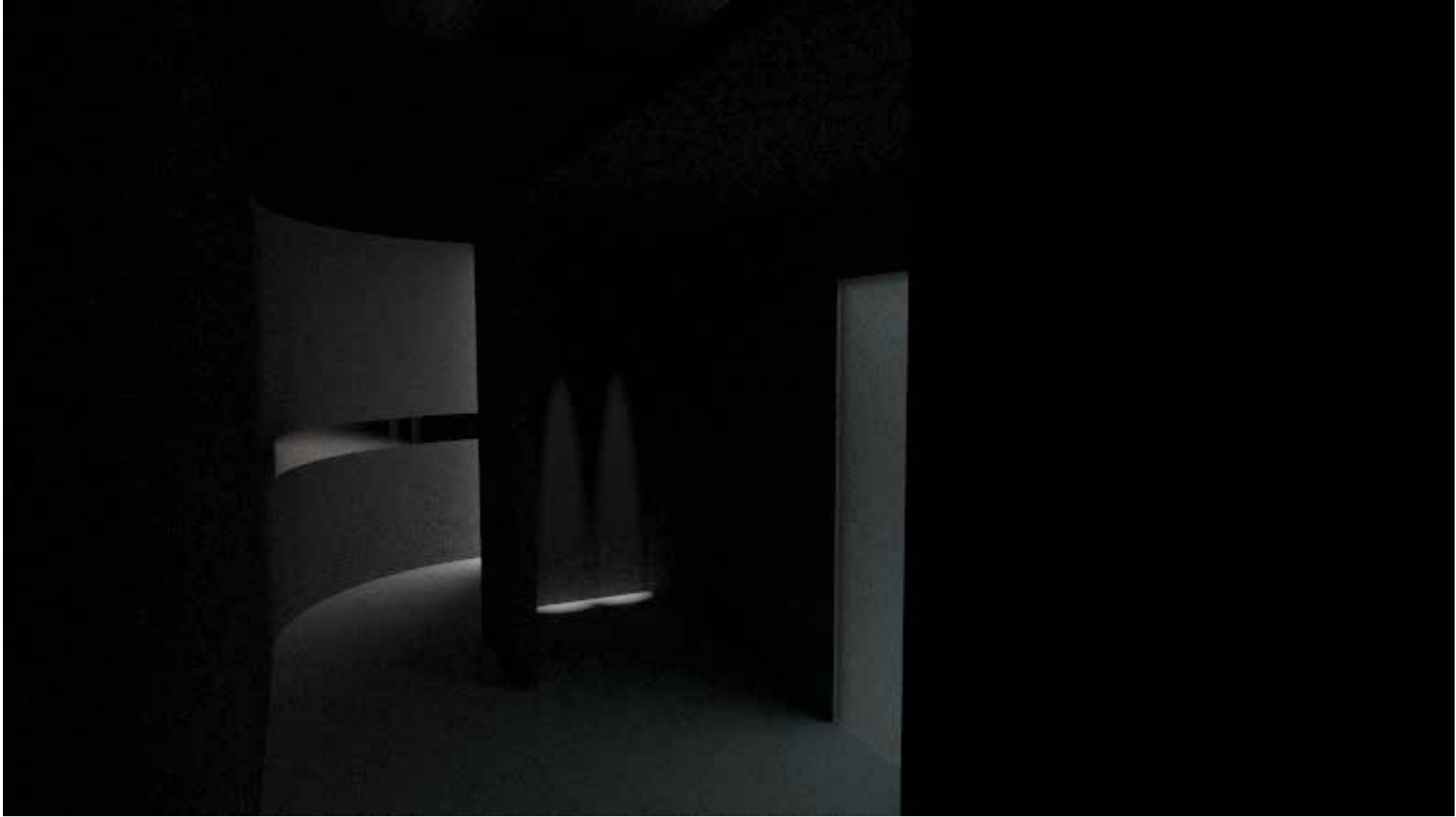



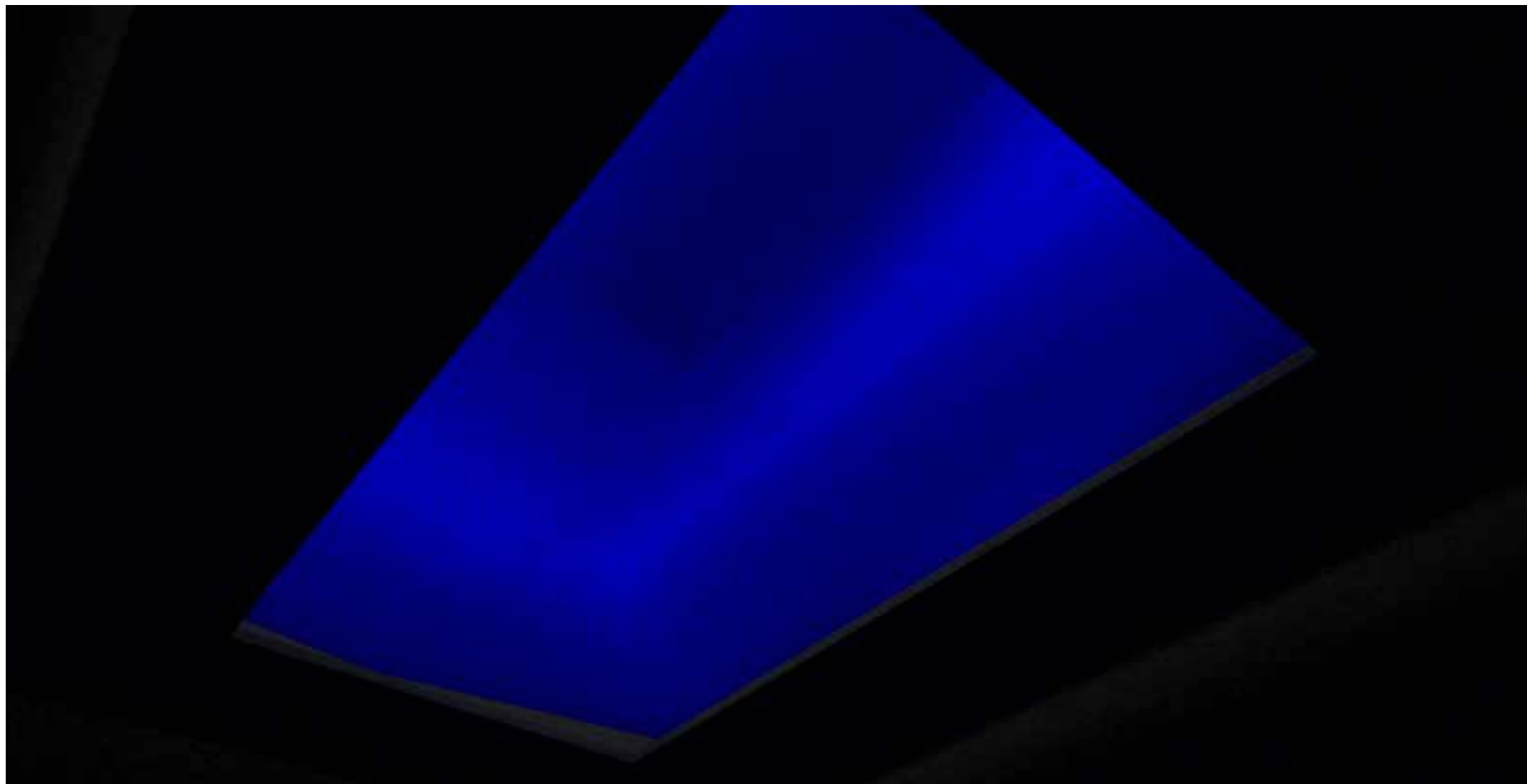









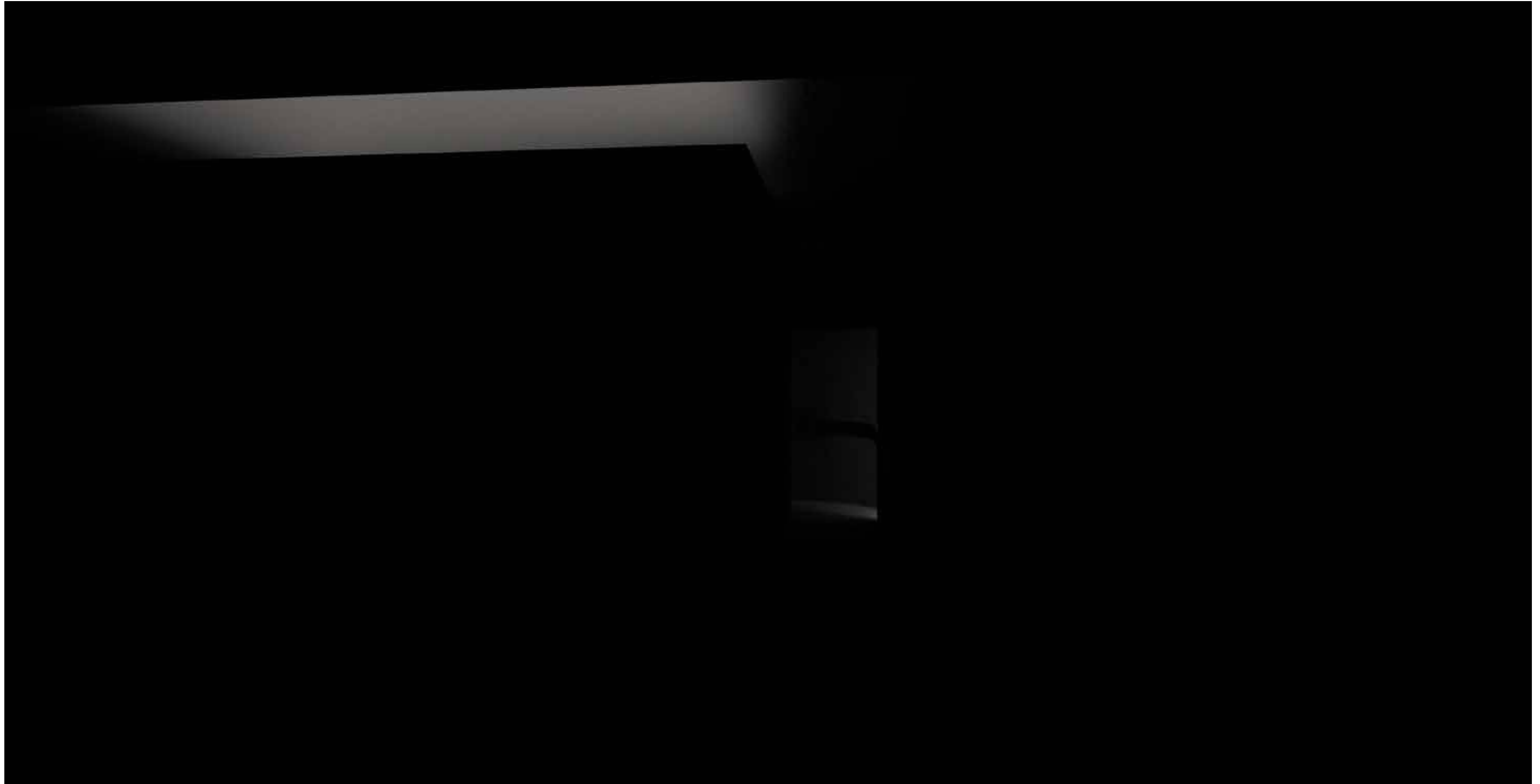



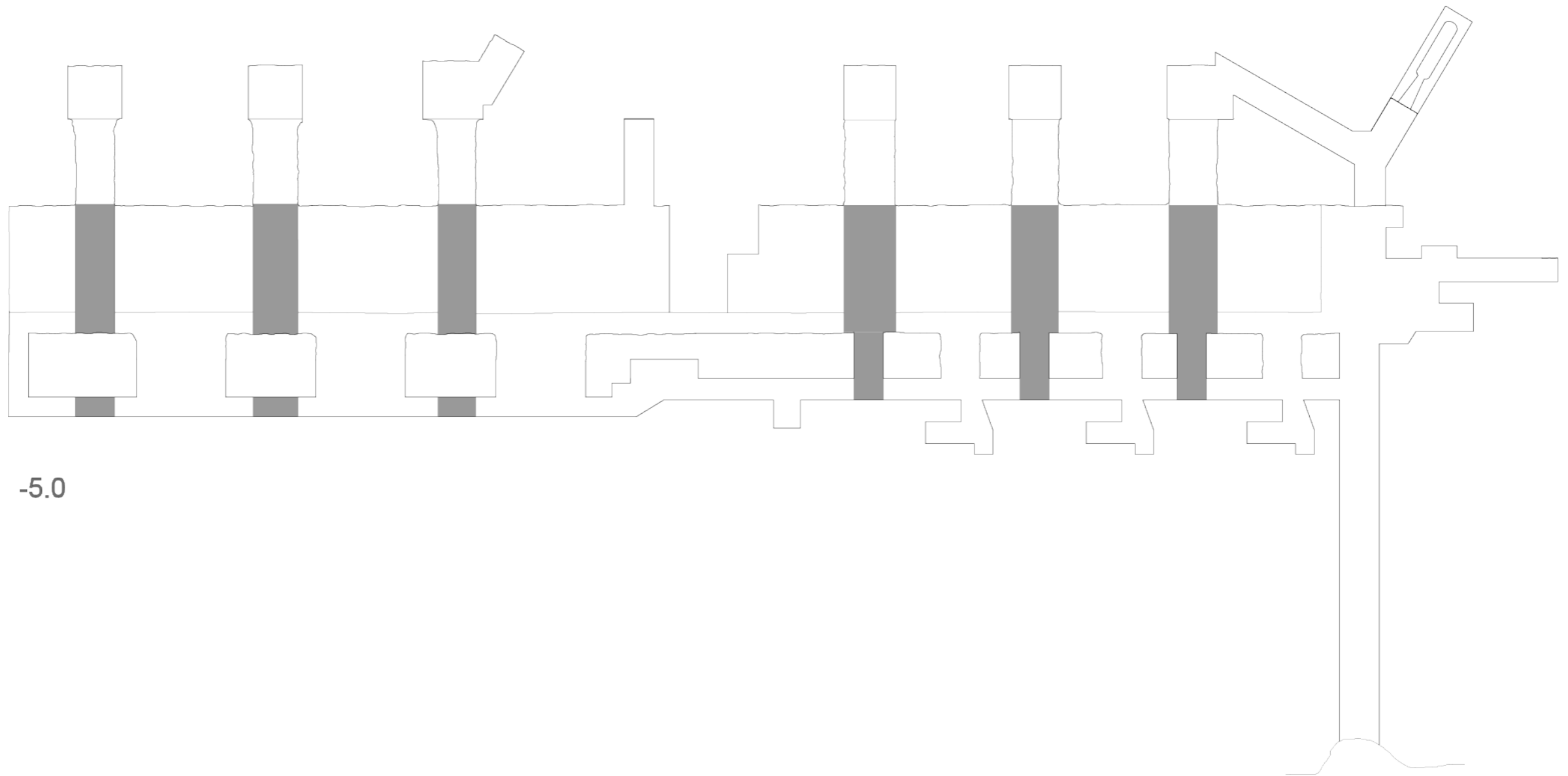

-5.0





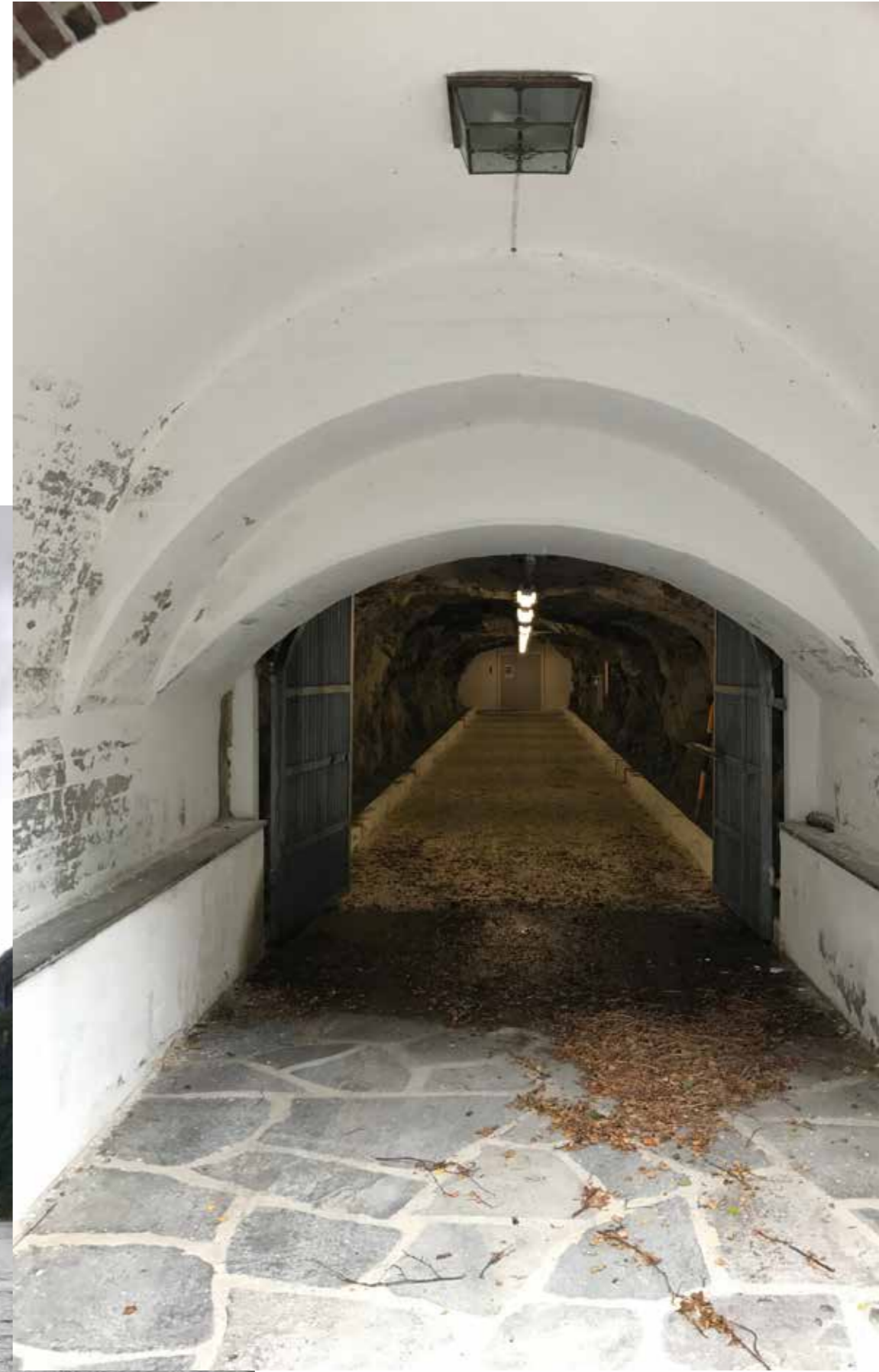

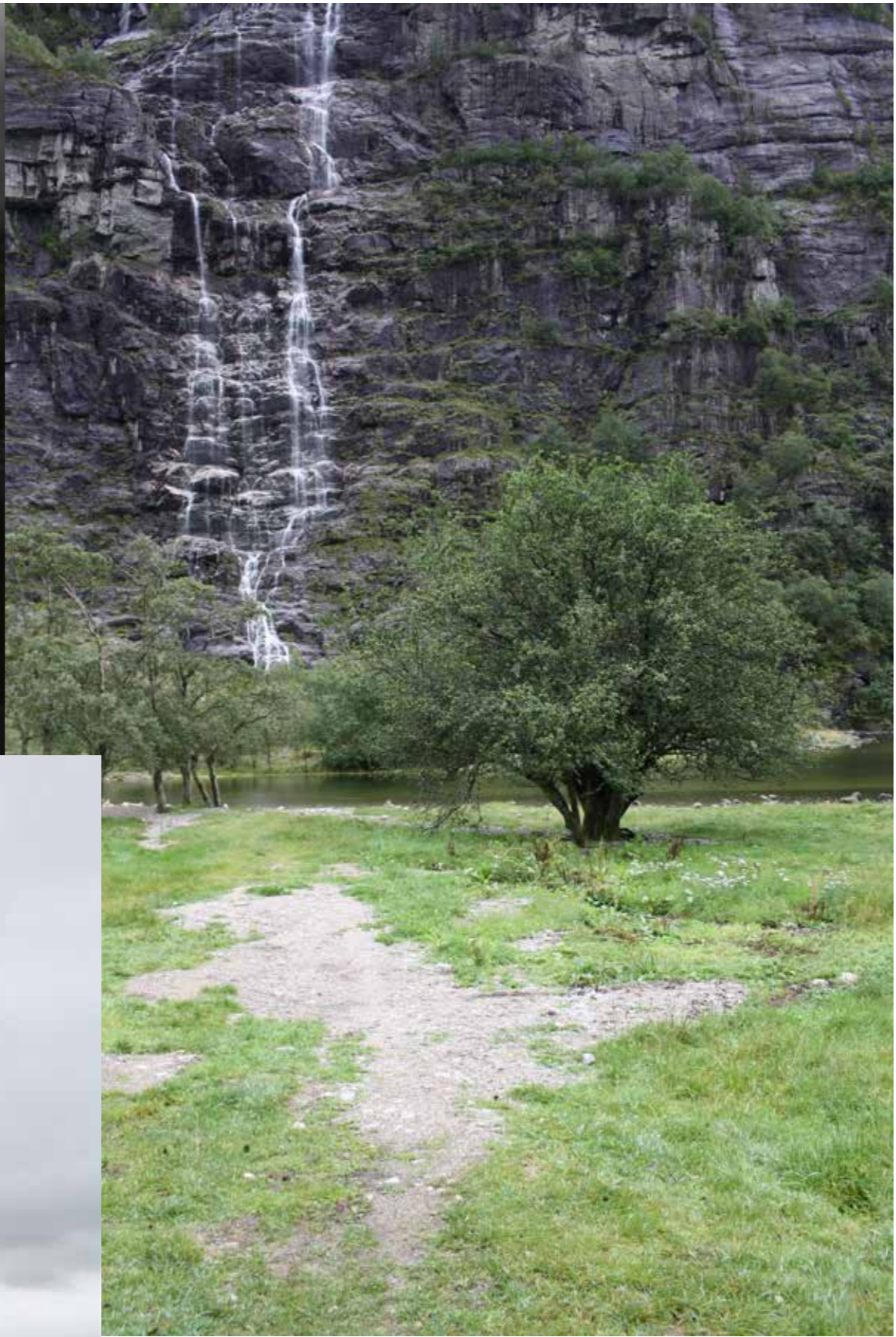
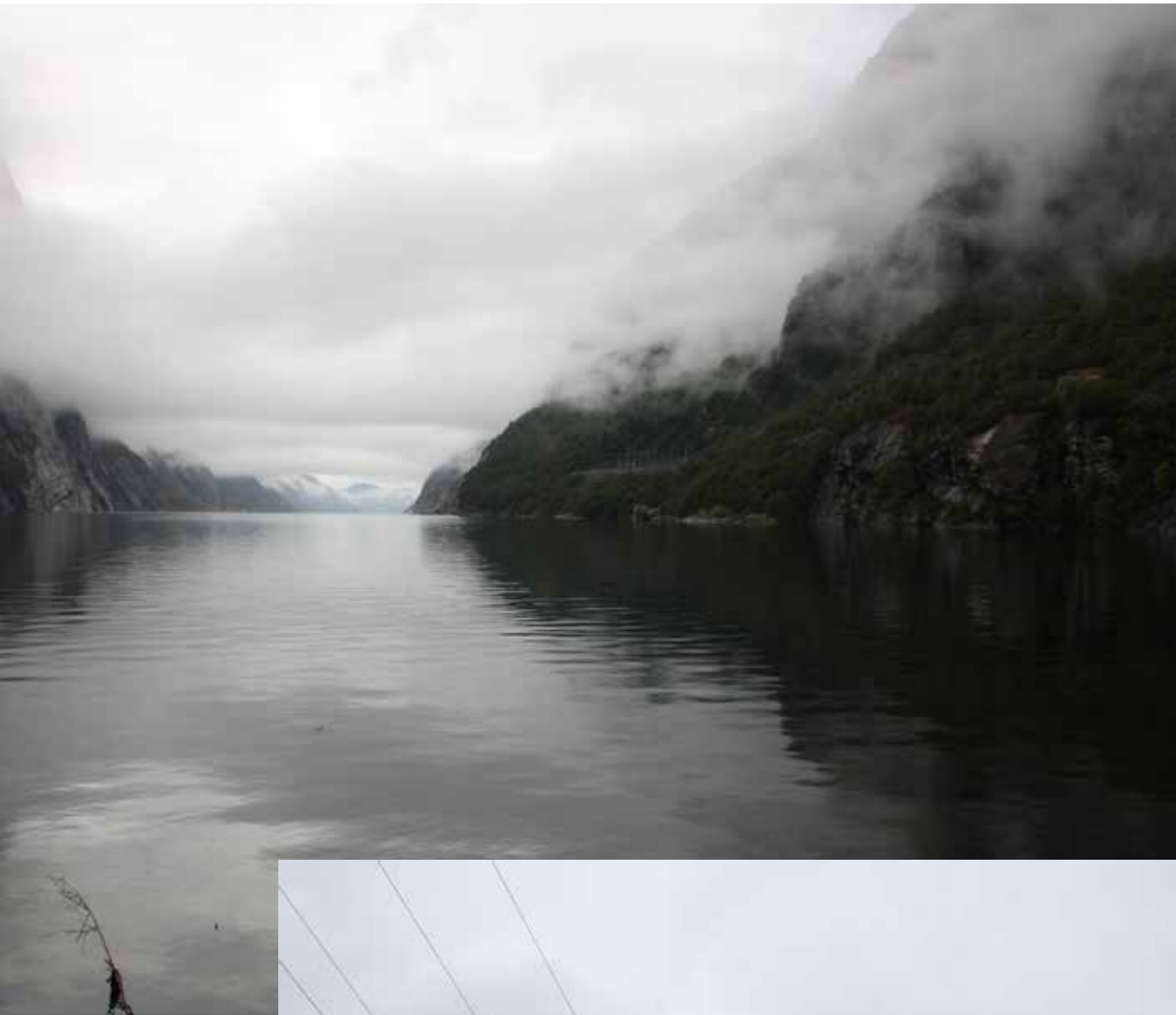

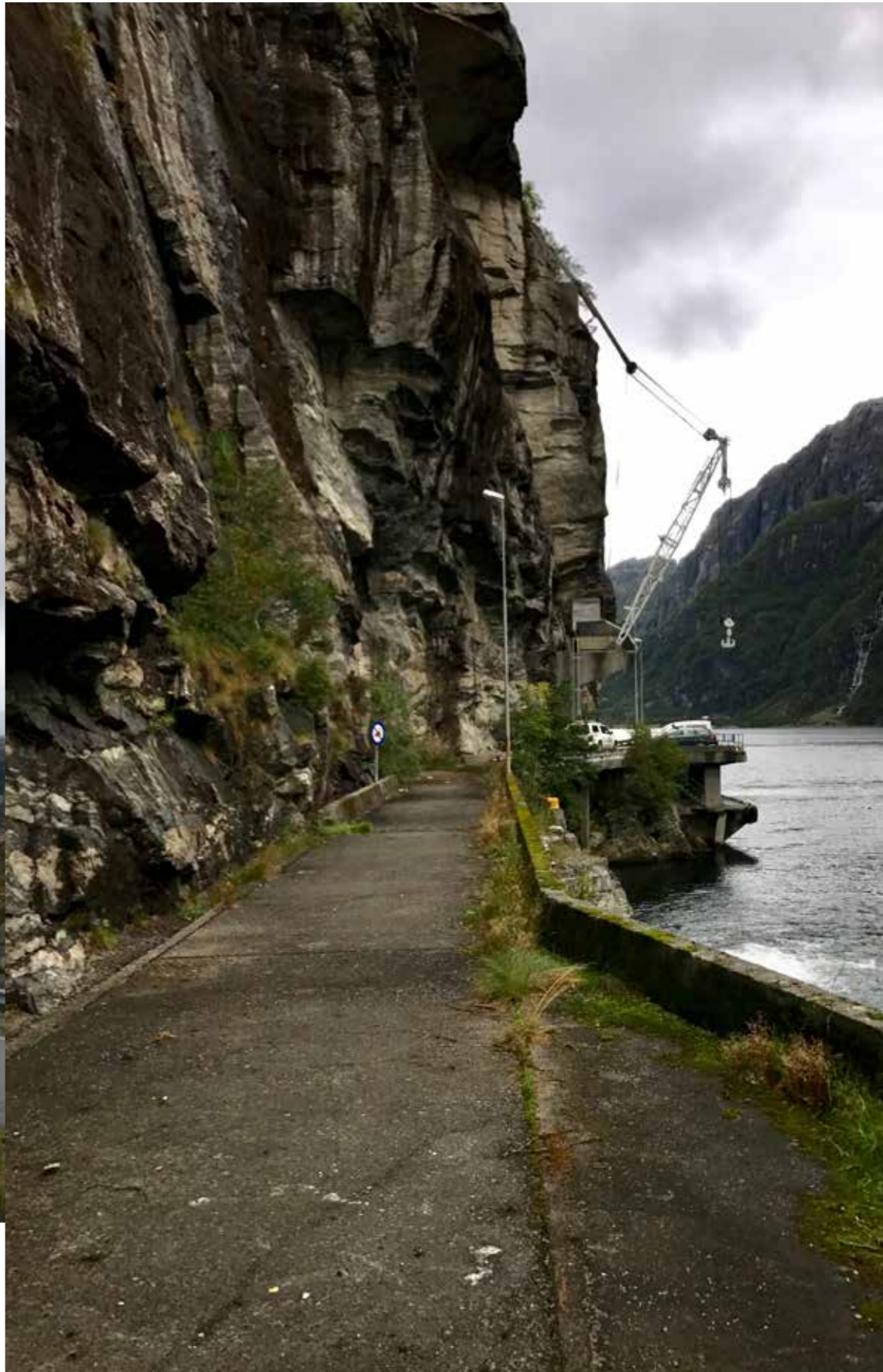

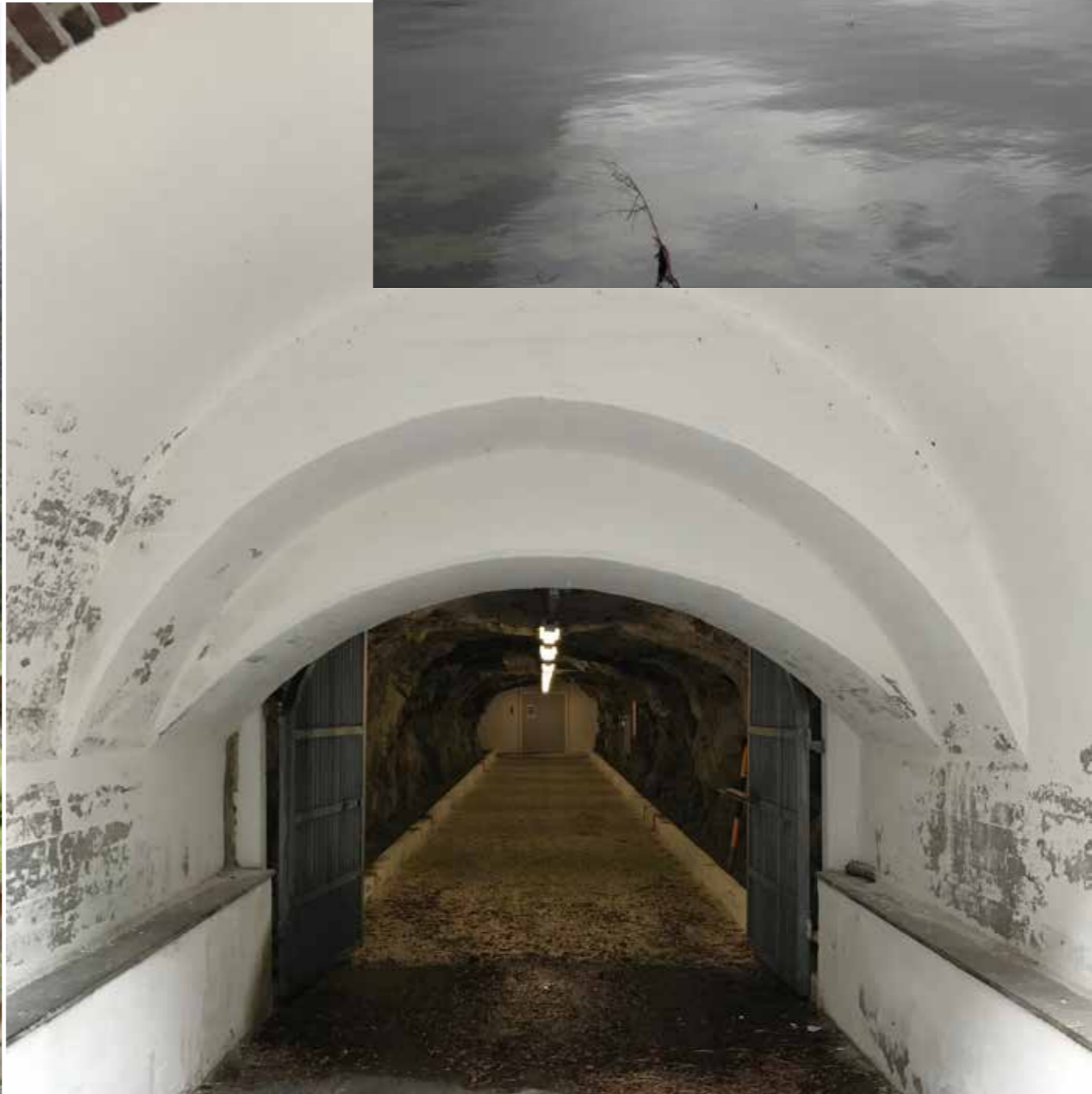





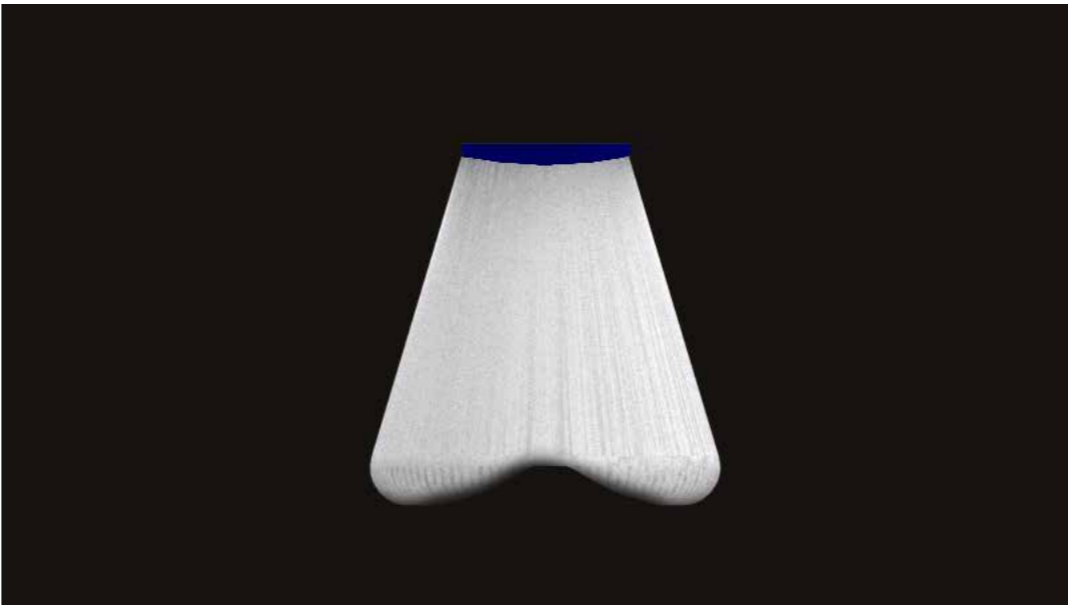



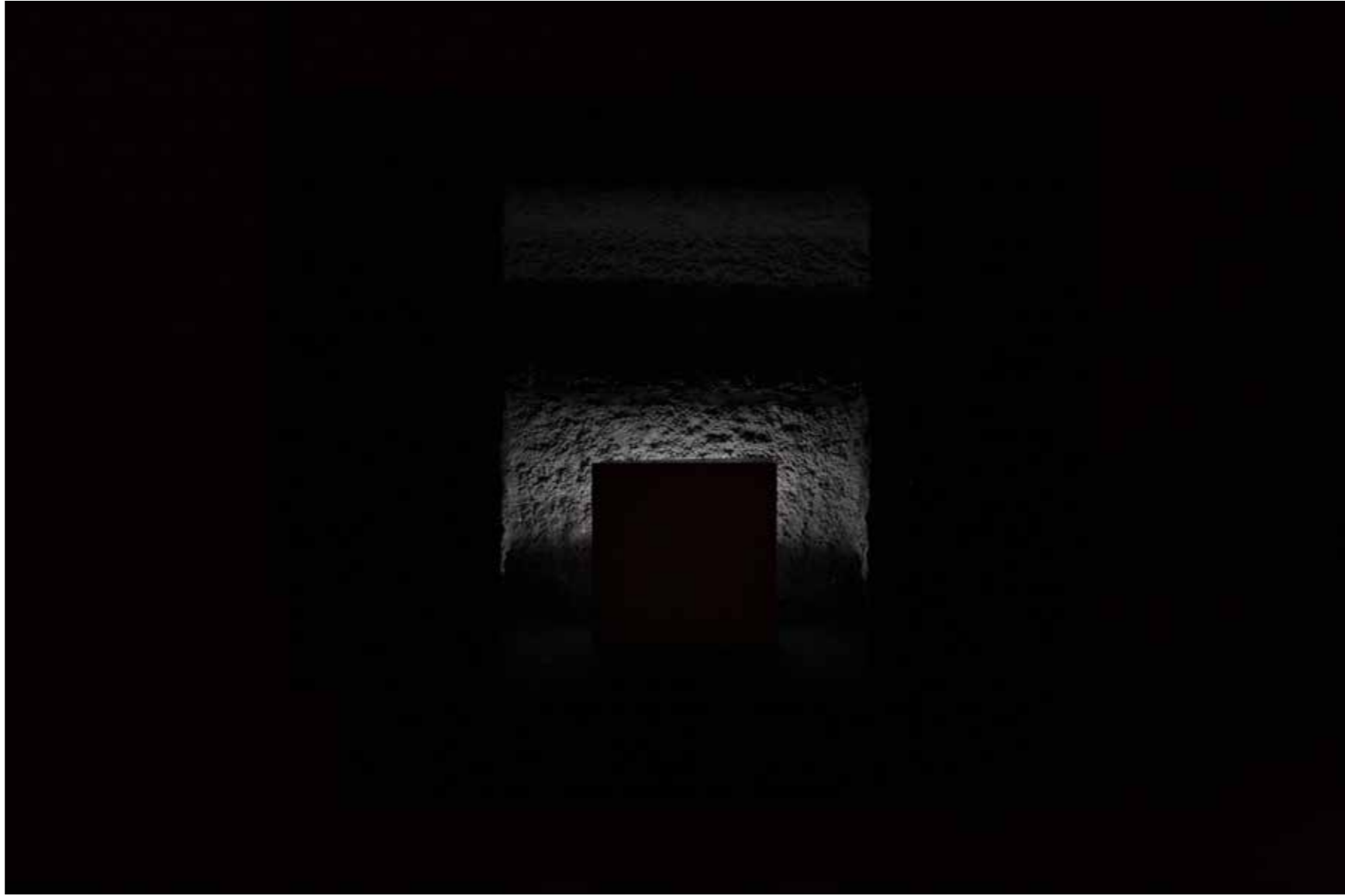



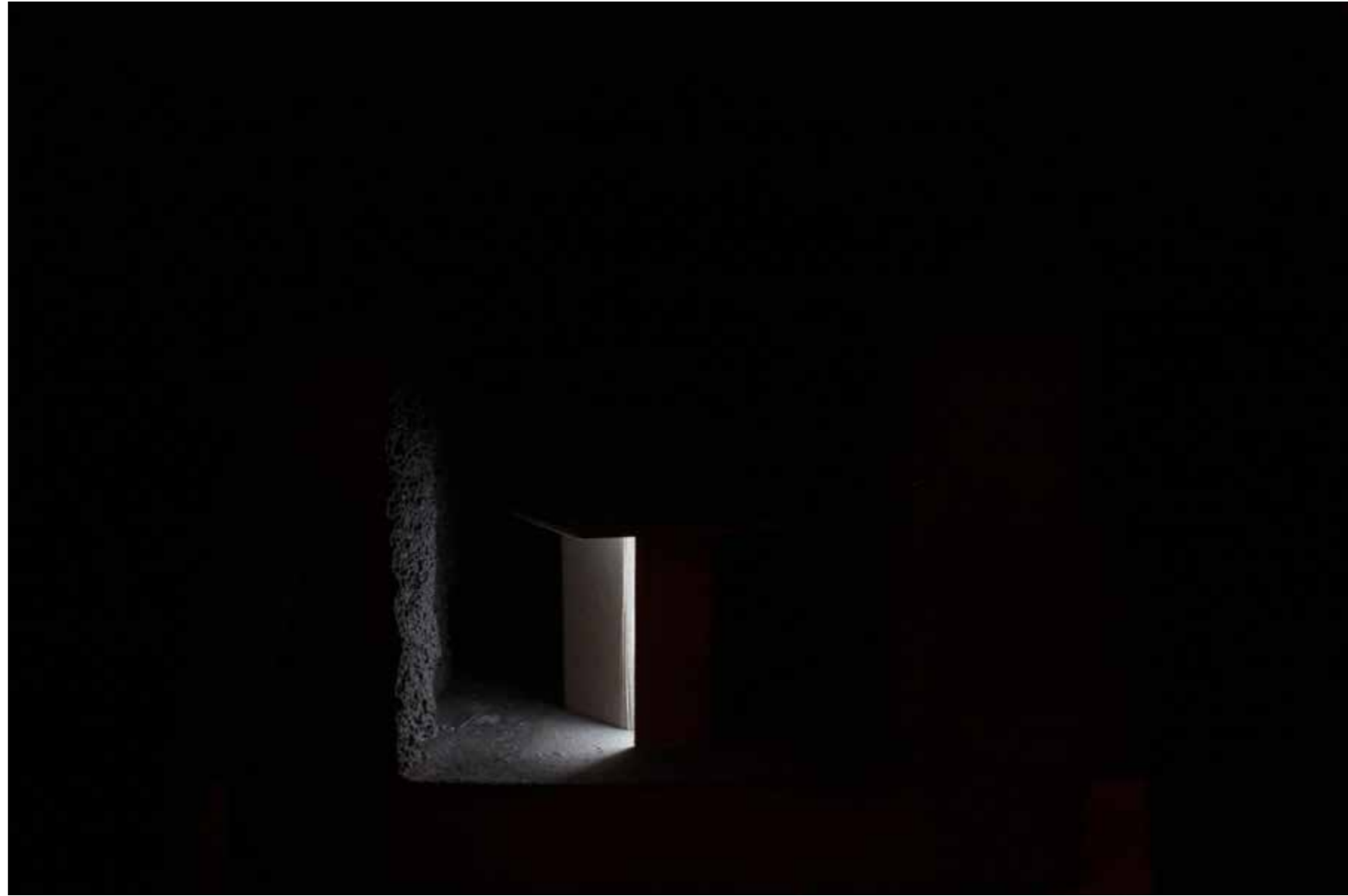

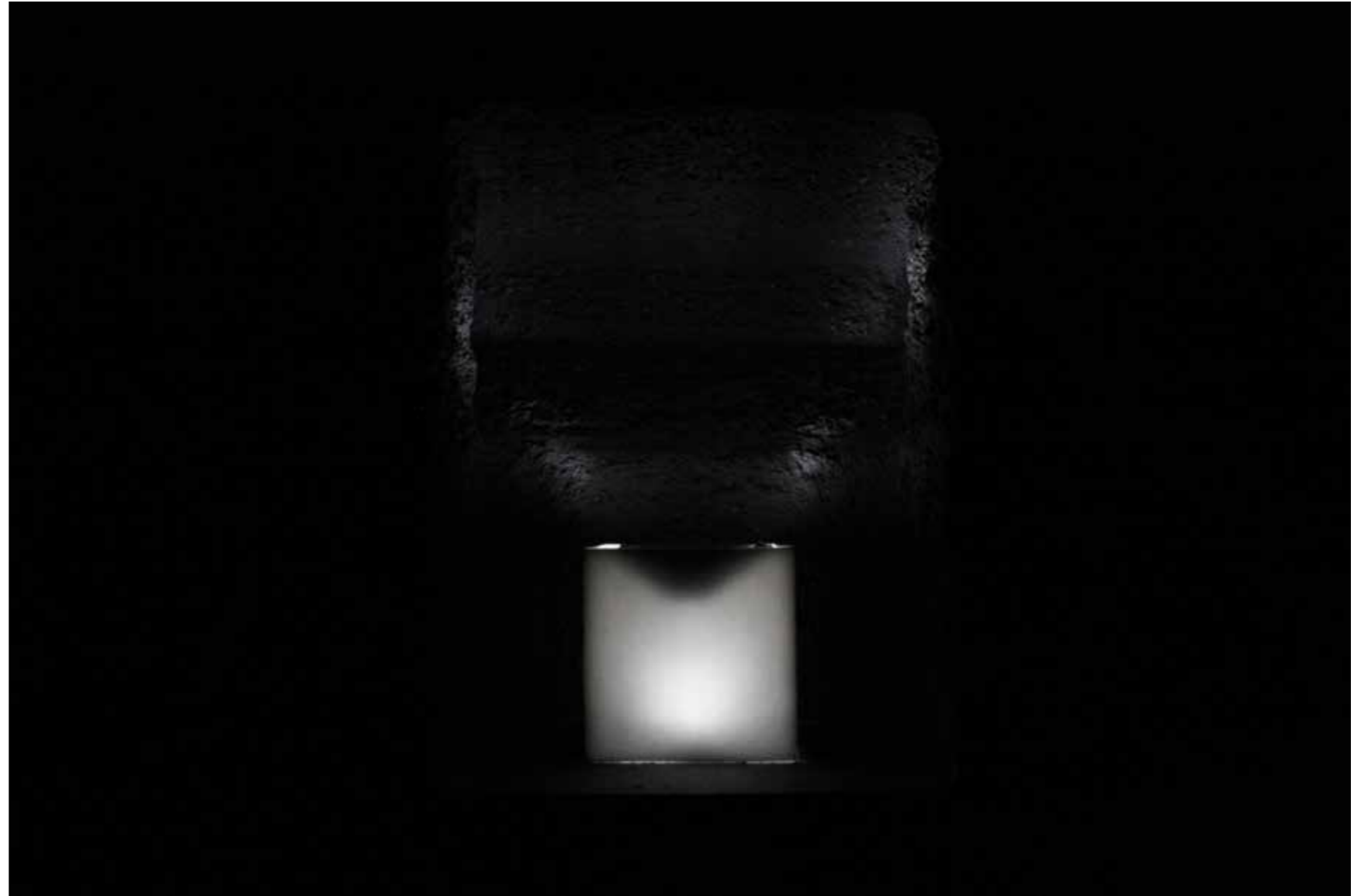



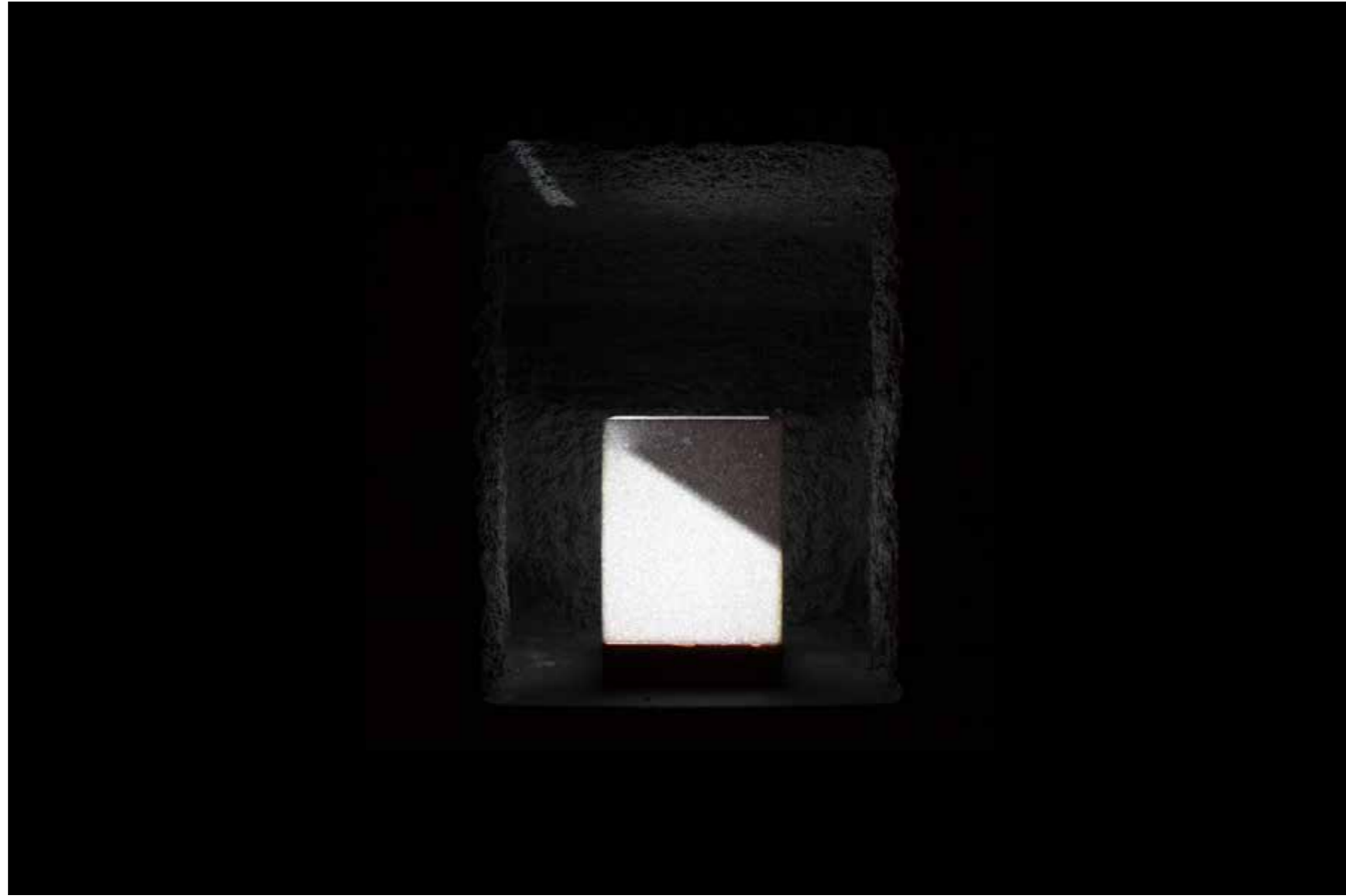



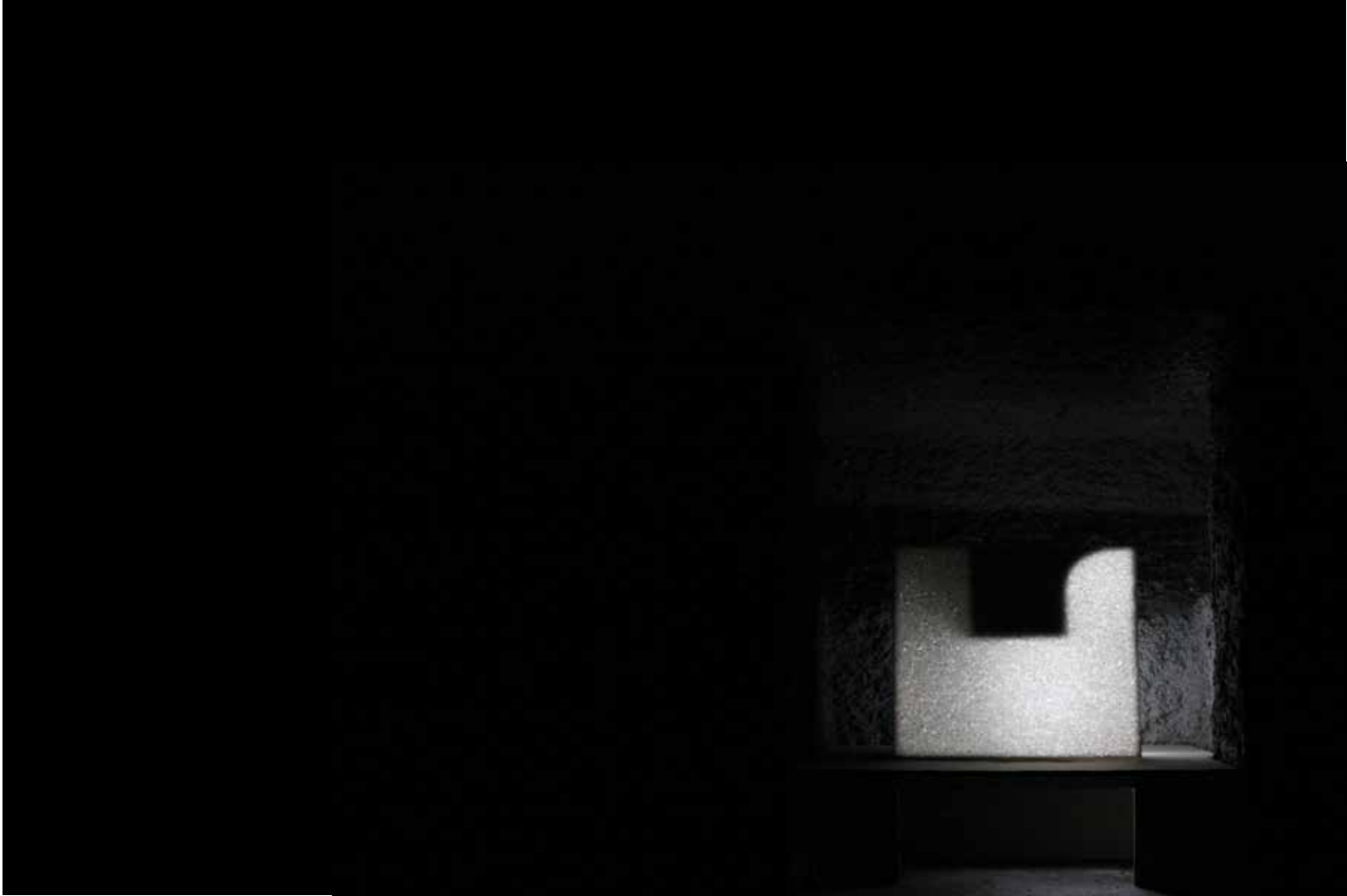



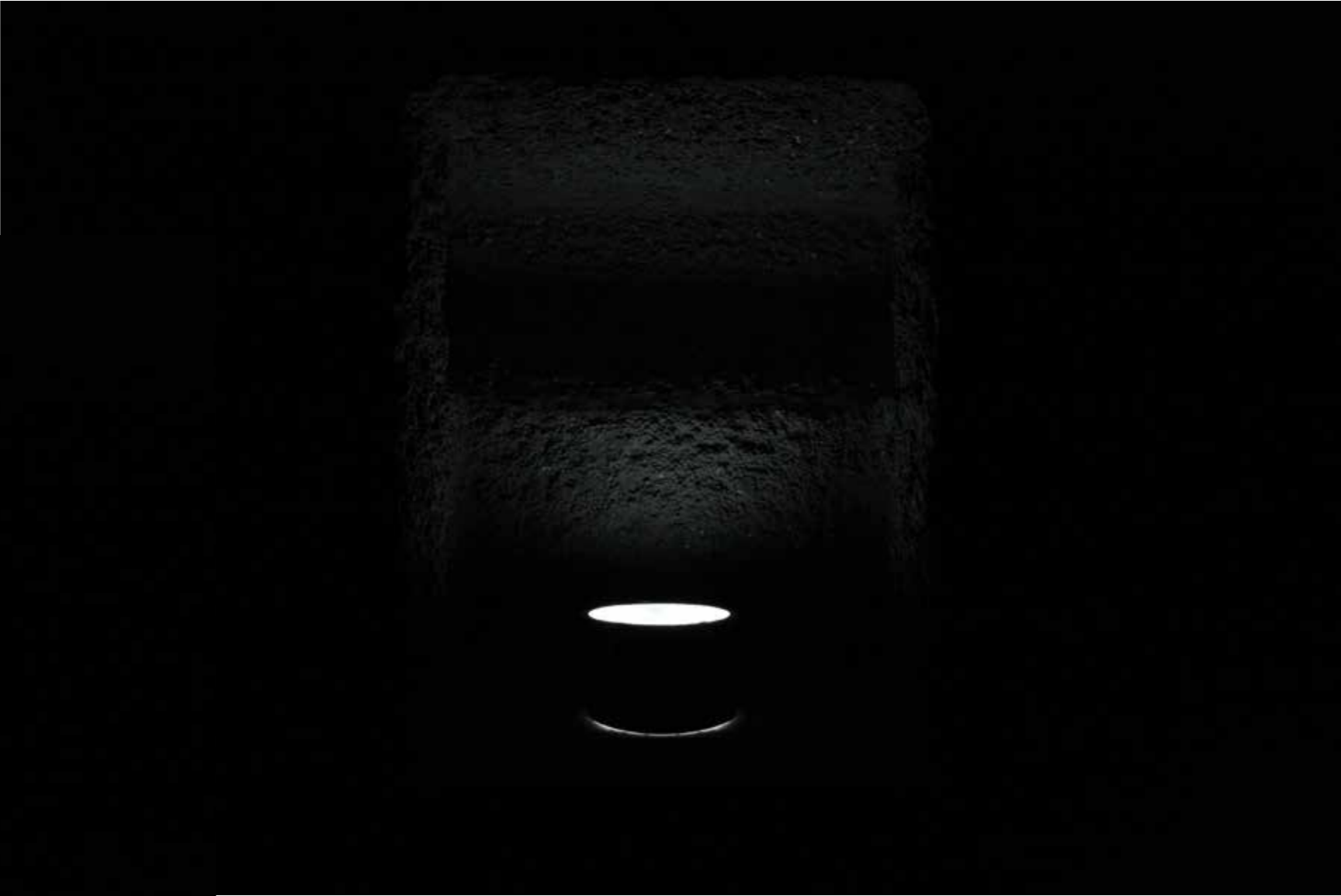





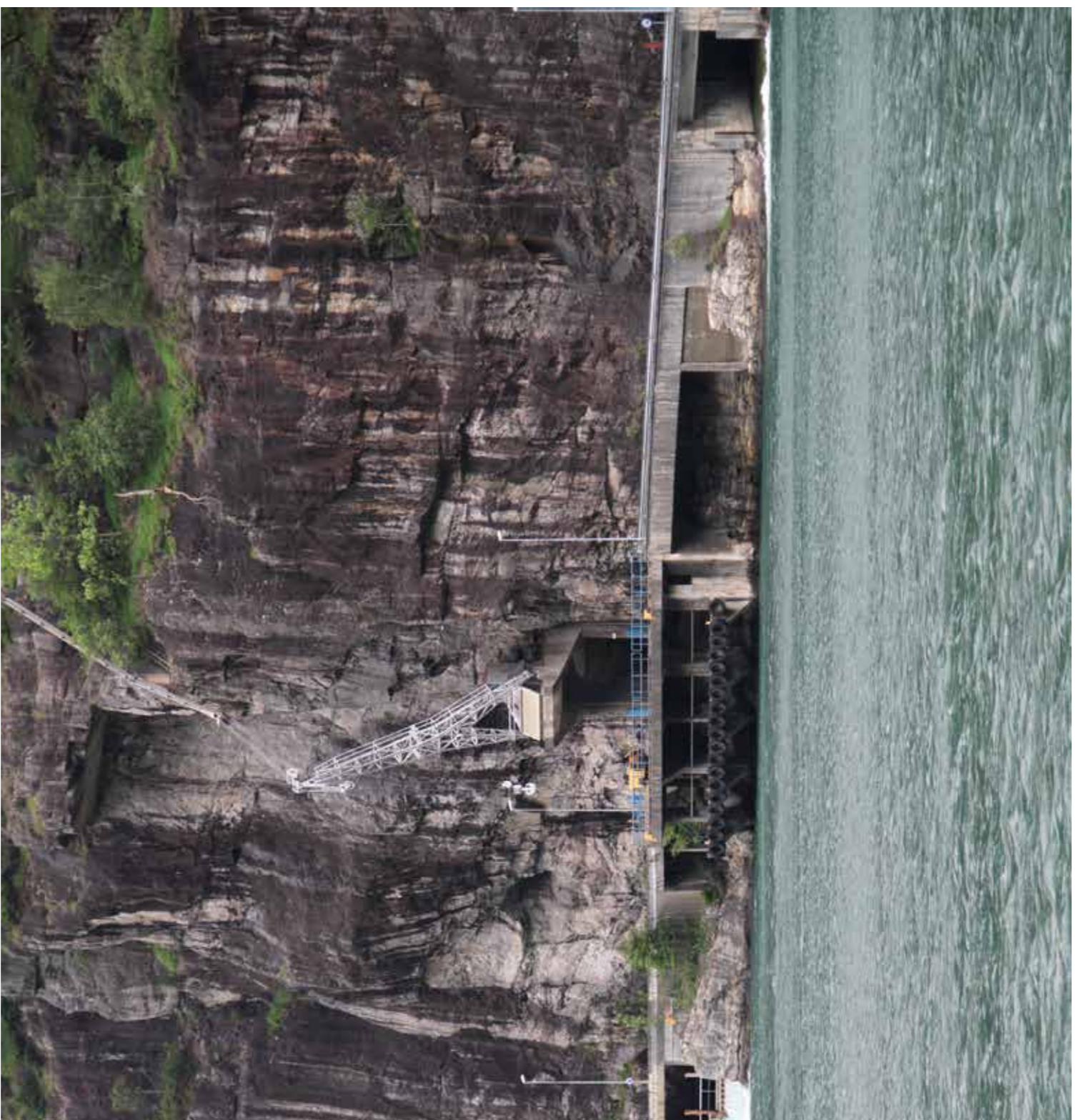

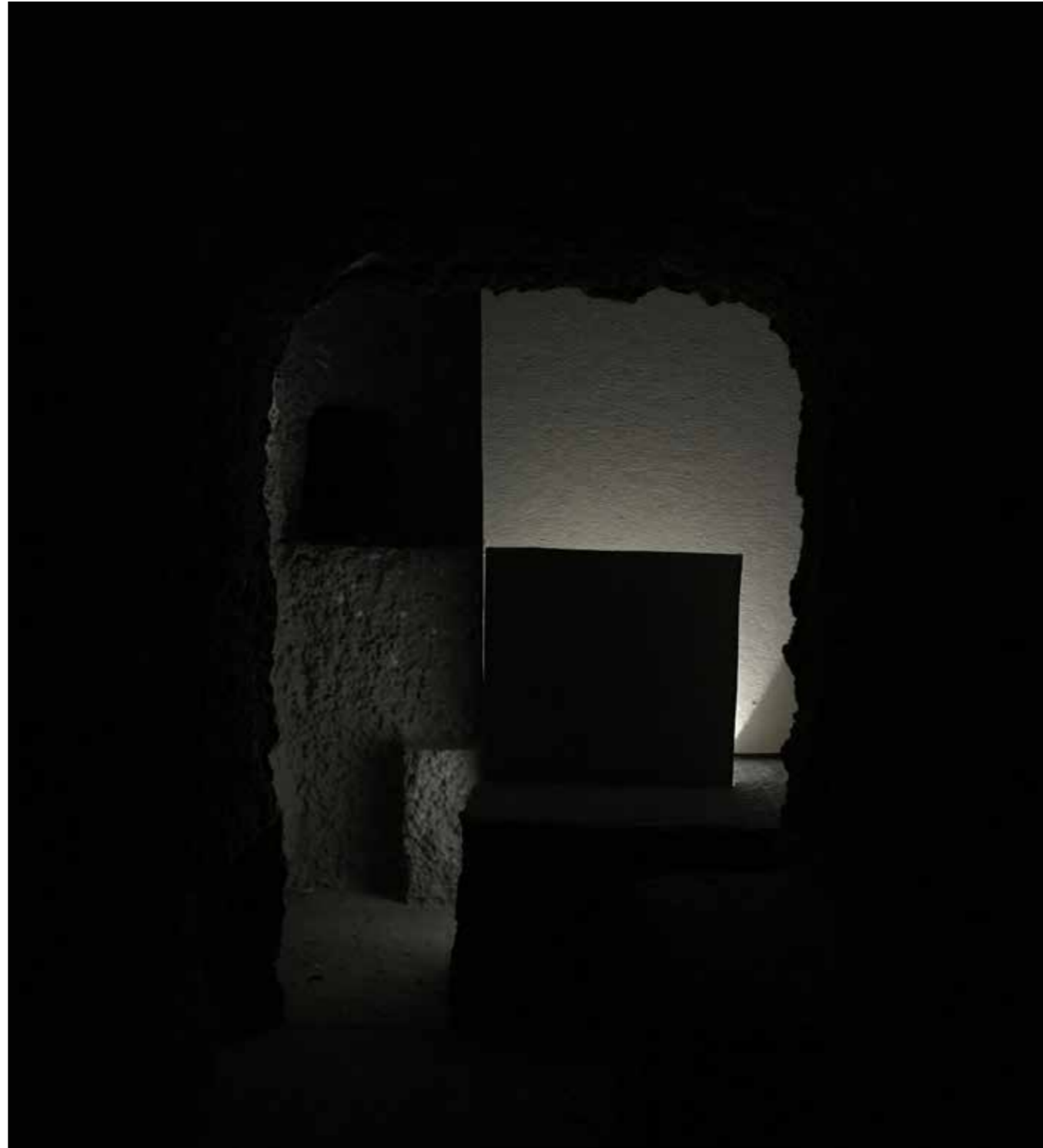





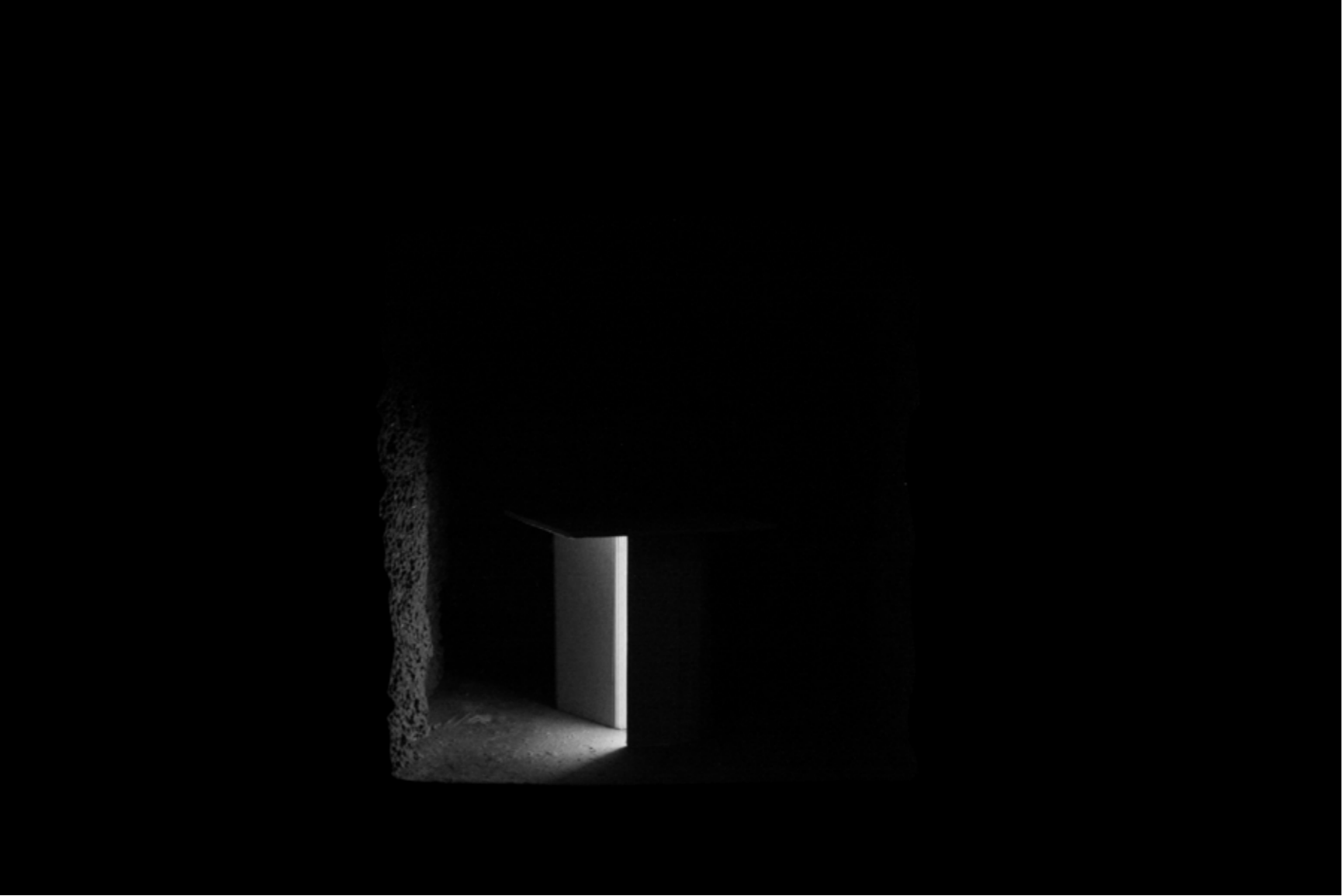



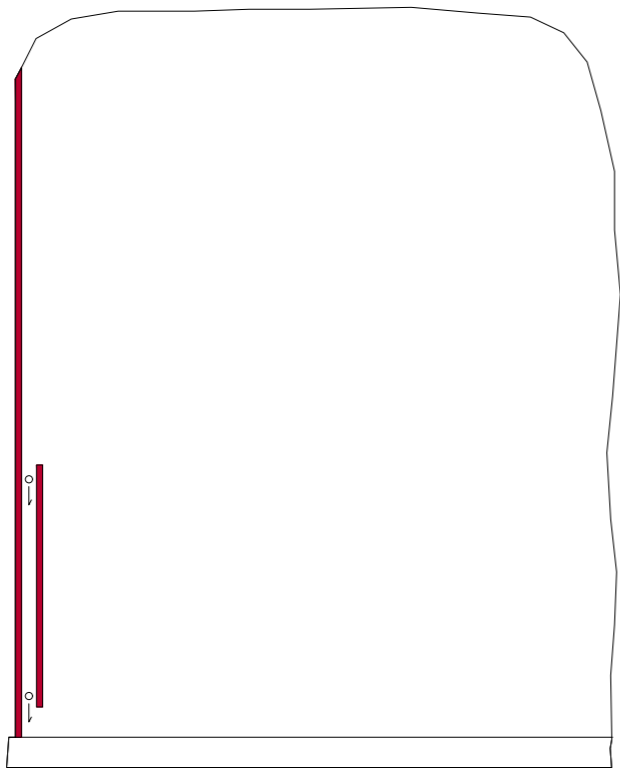

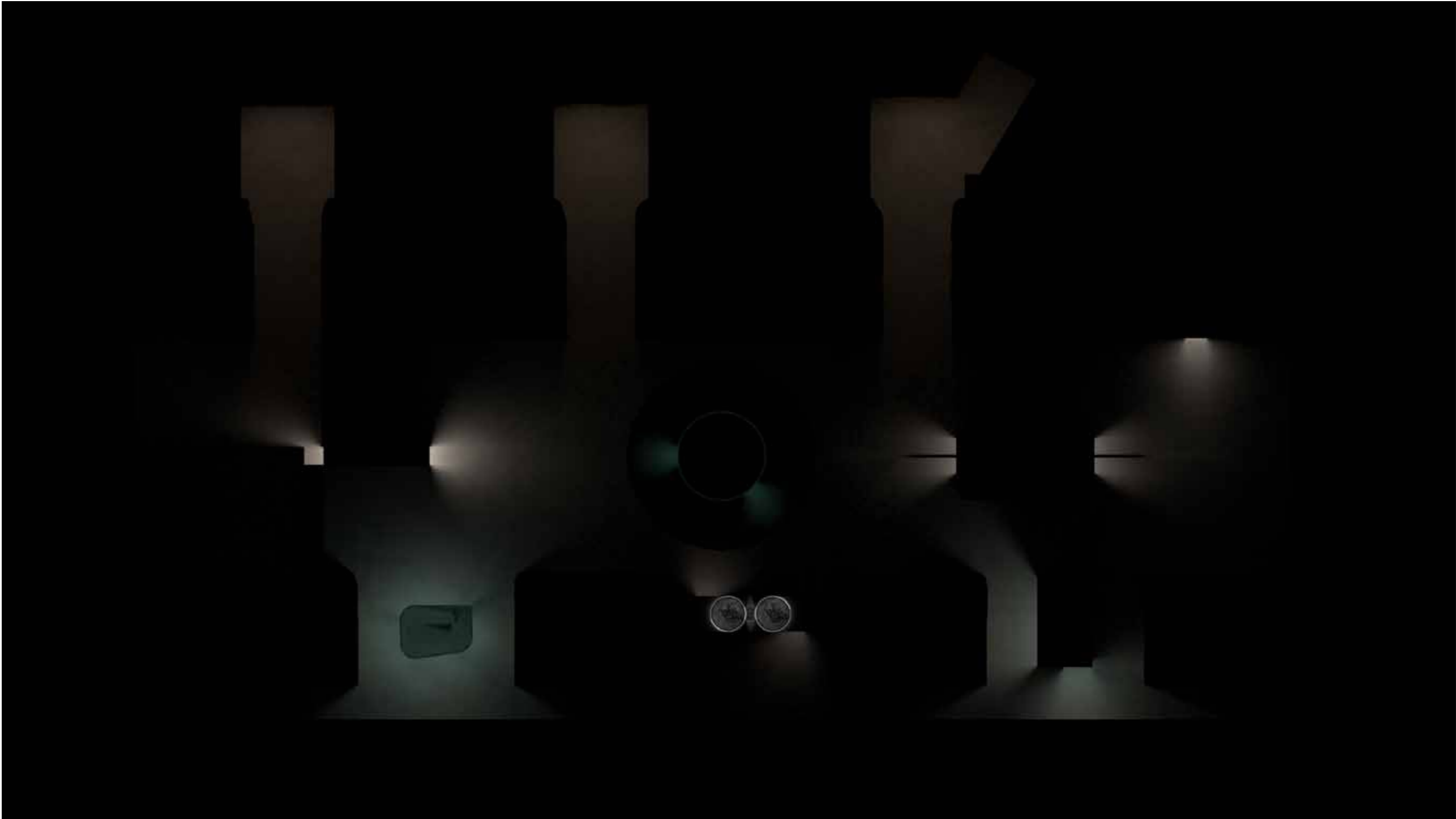

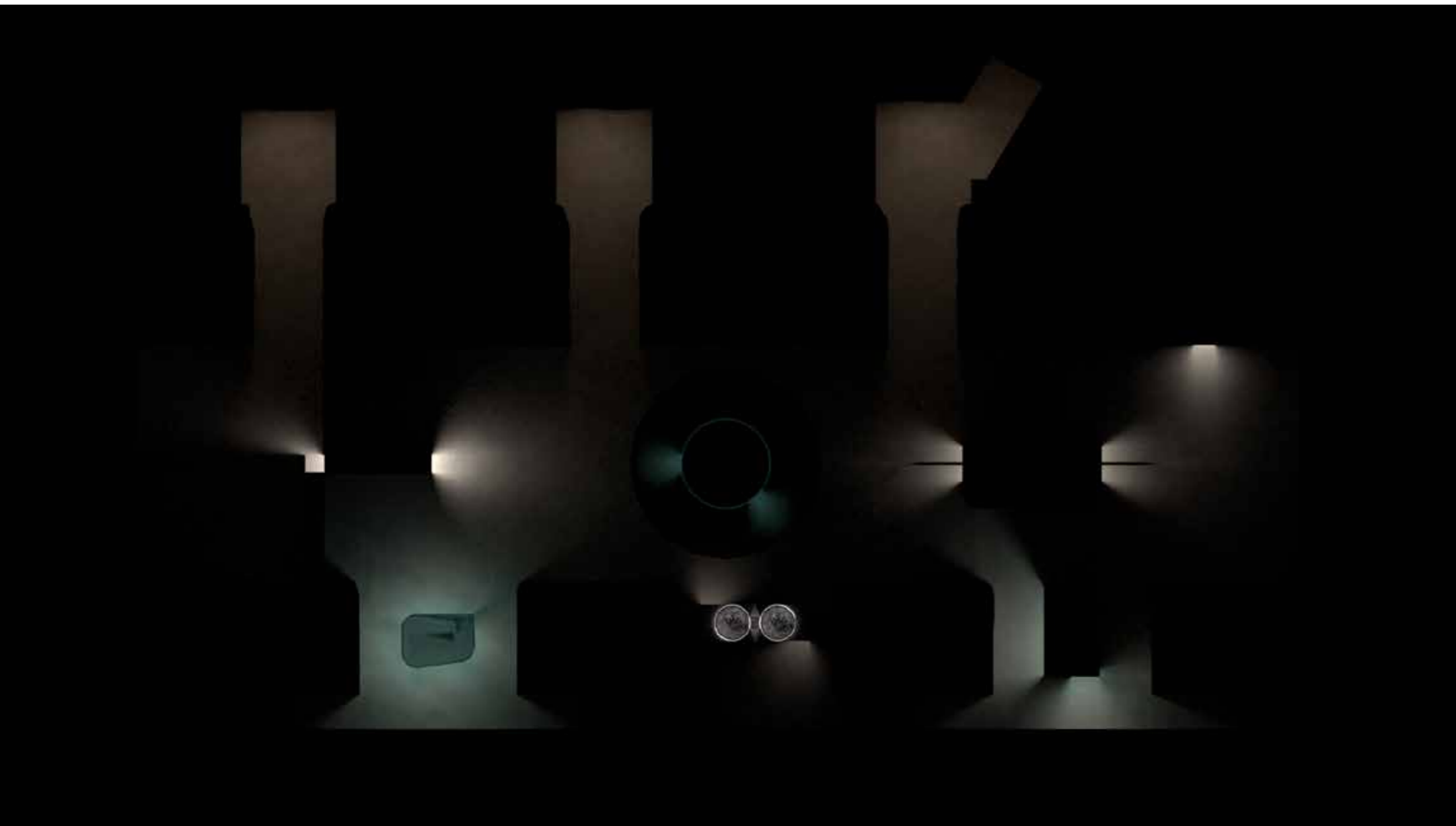

















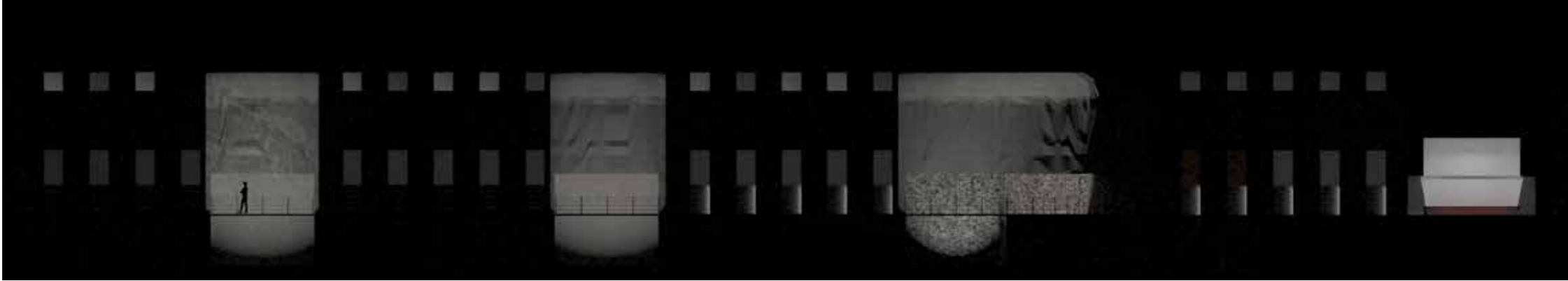

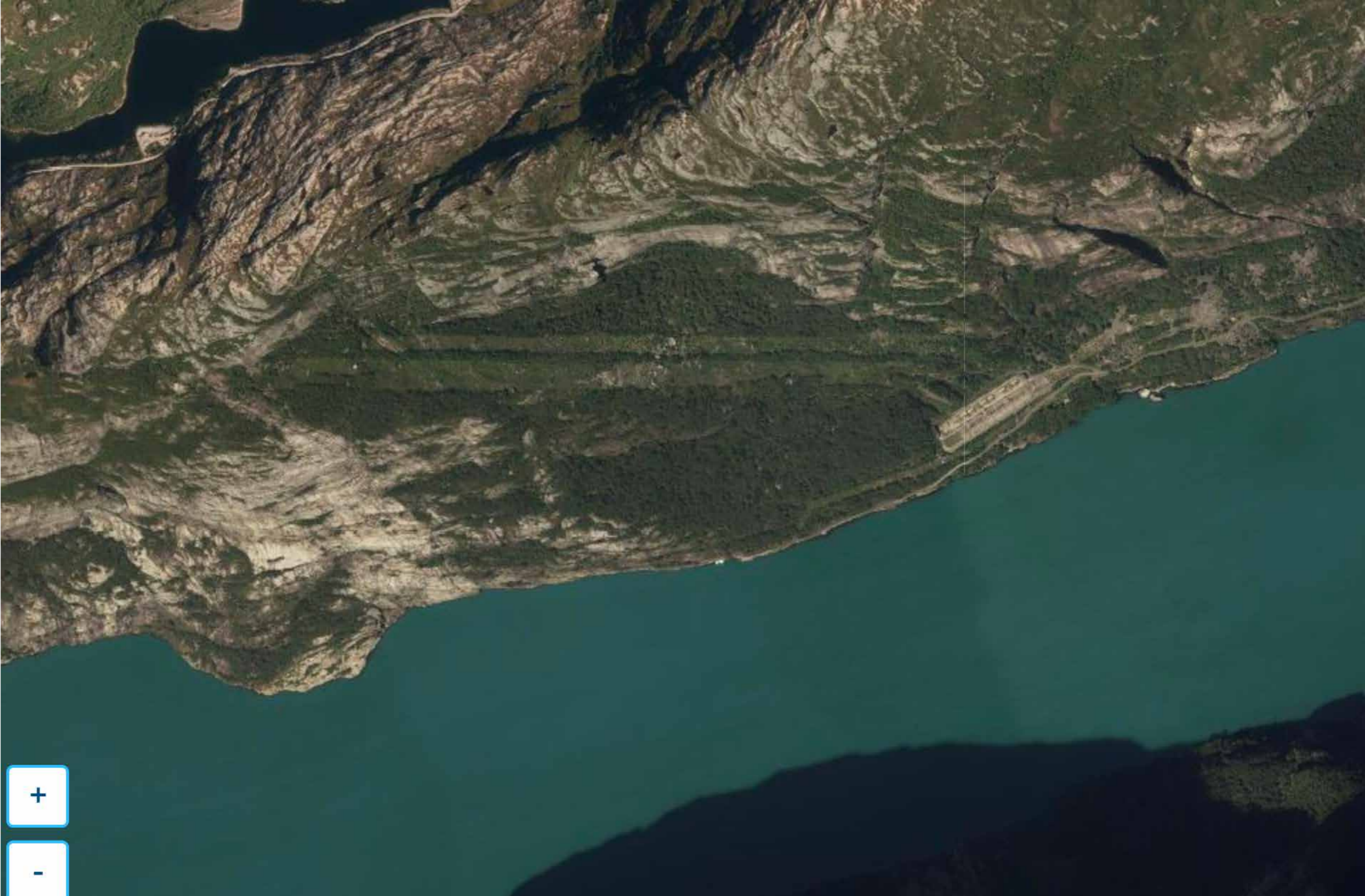

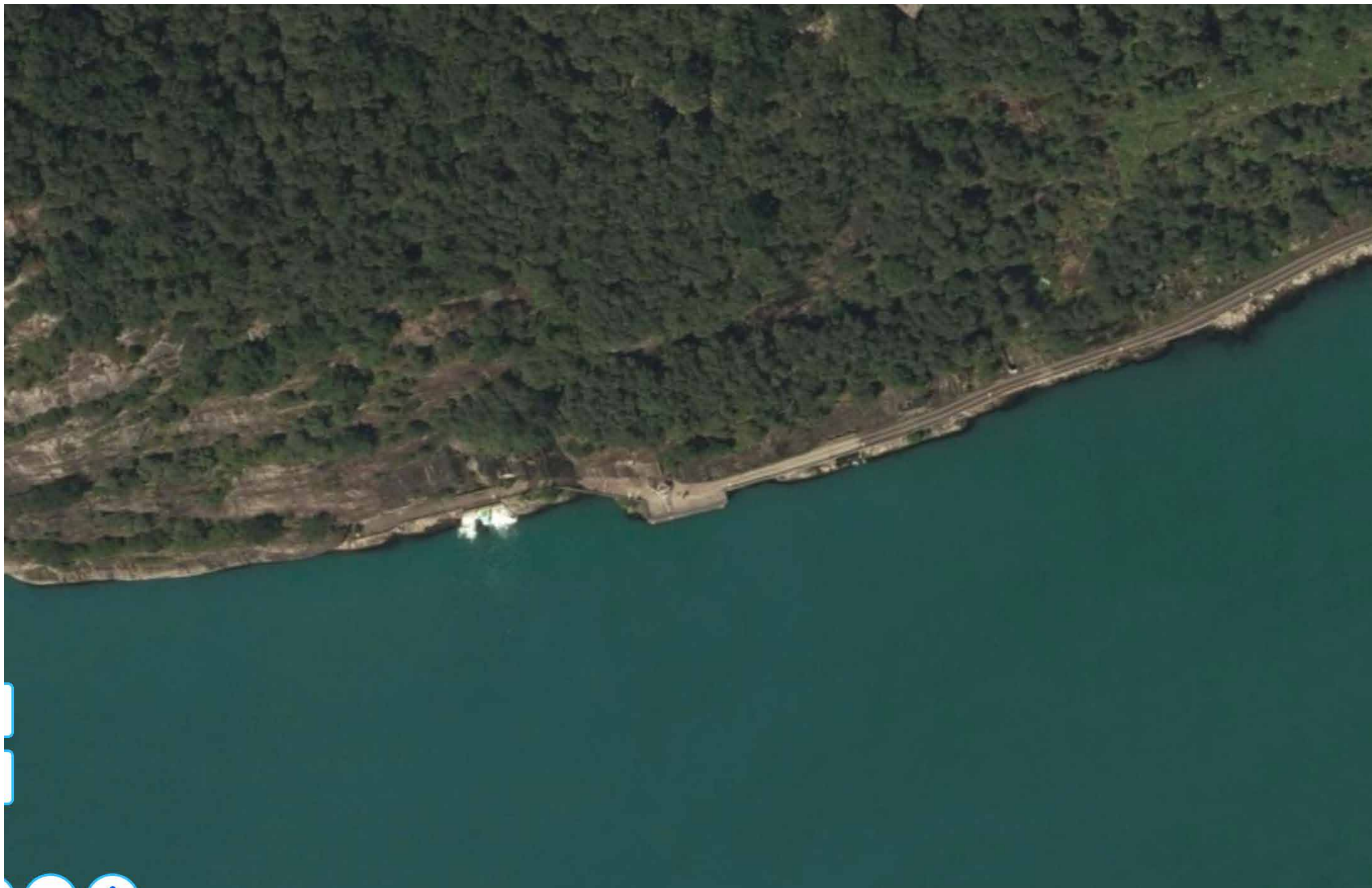

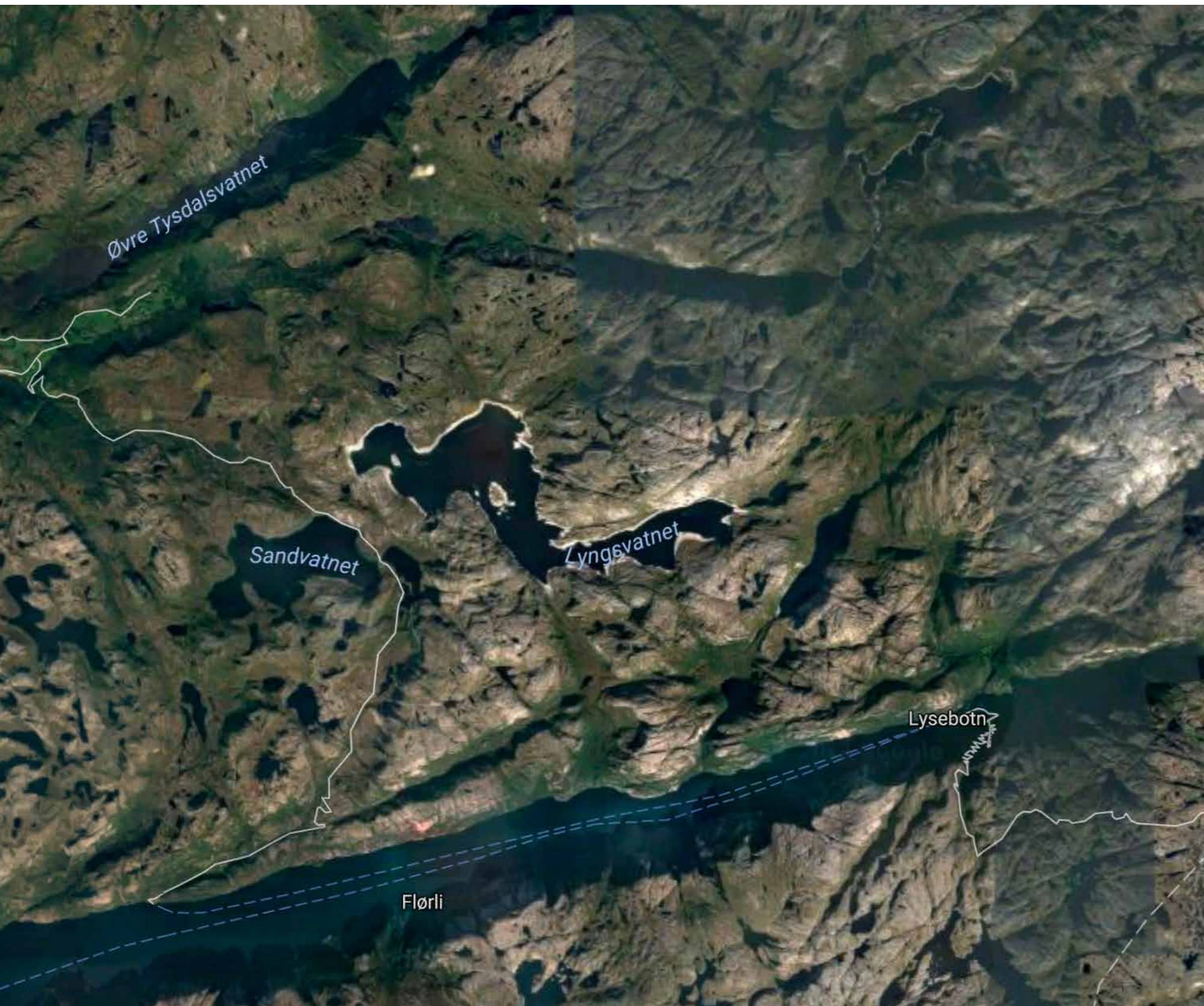

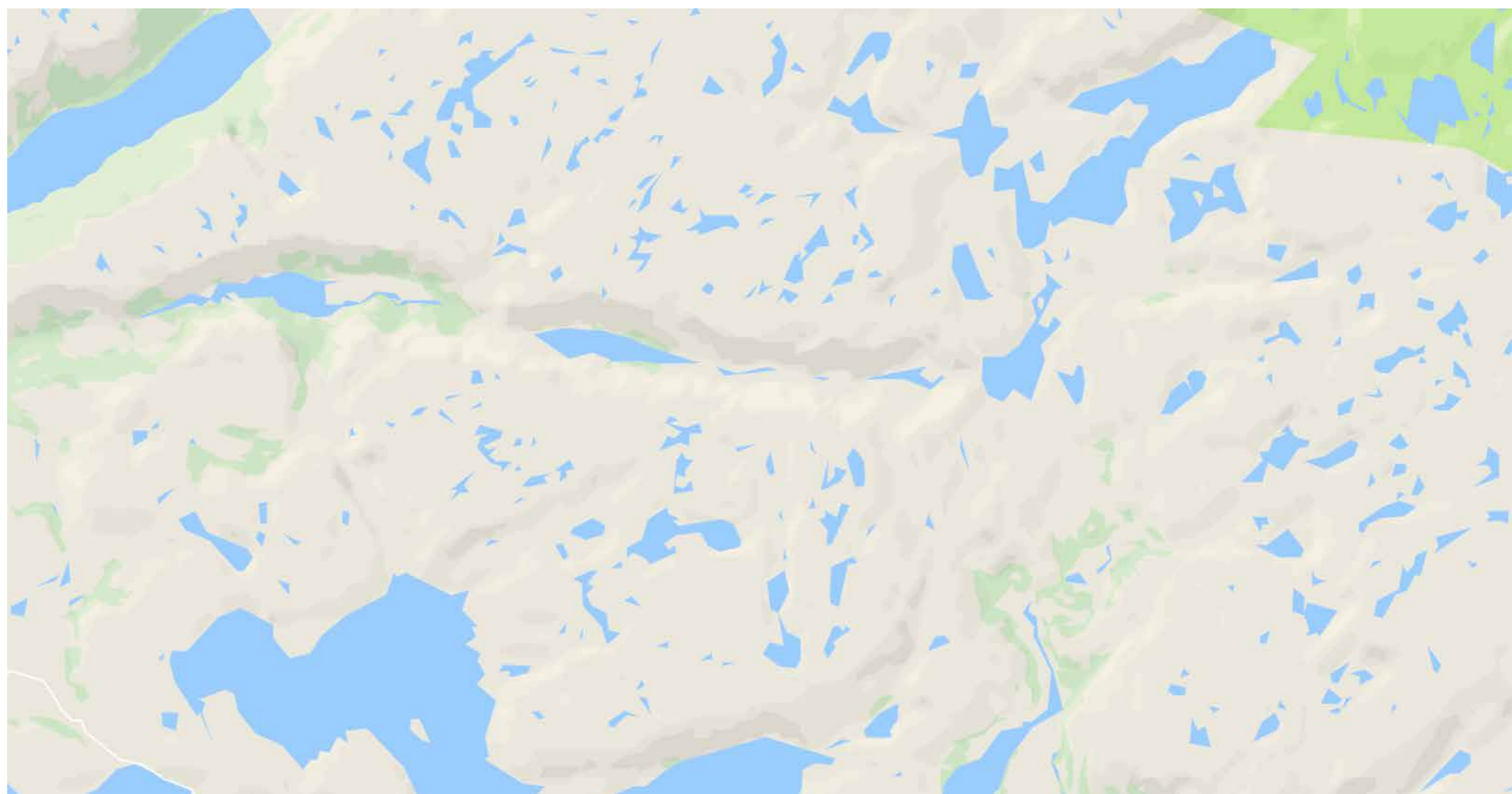

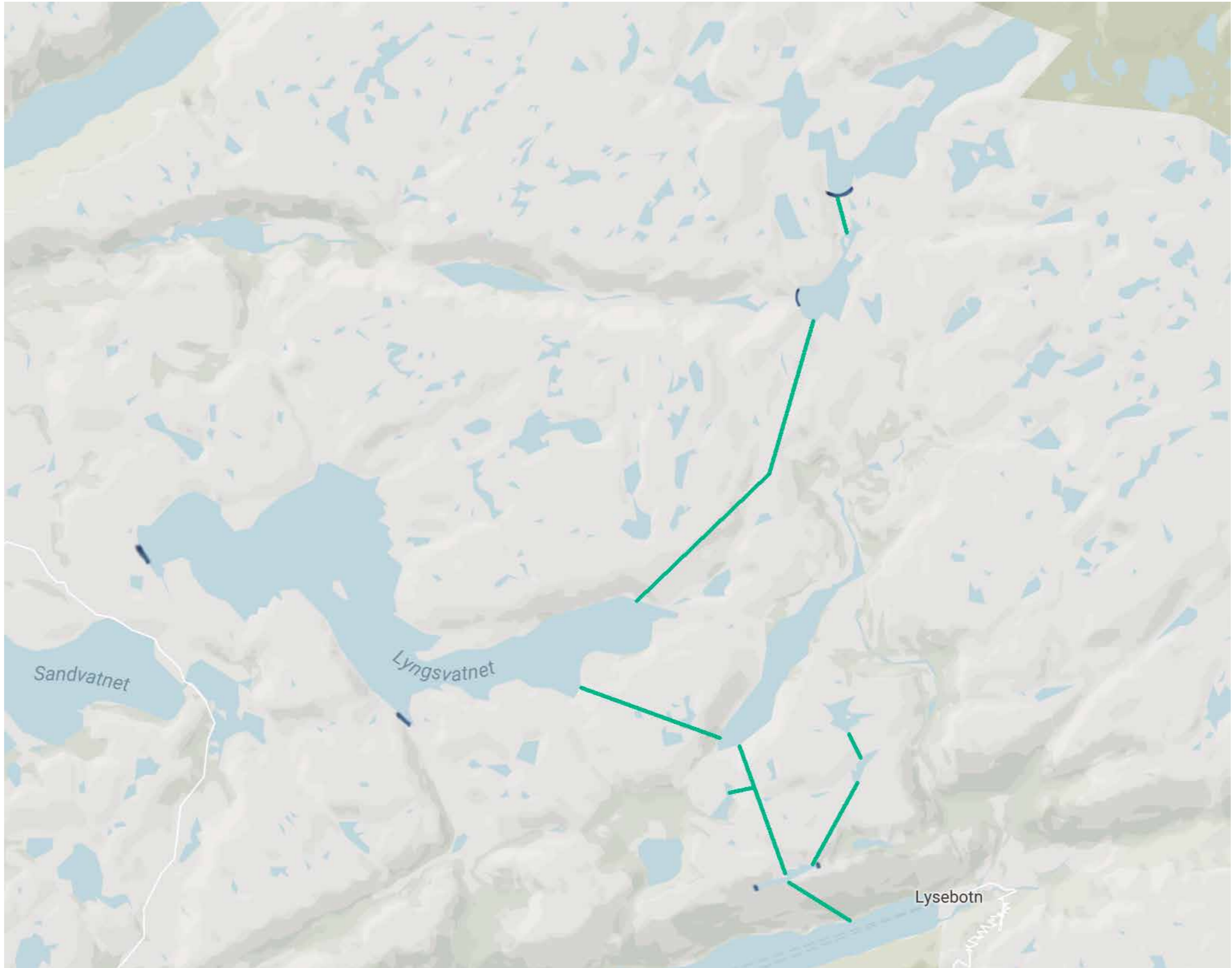











**Anlegg:**

Lysebotn 1

**Oppstartsår:**

1953, utvidet 1964

**Arkitekt:**

Gustav Helland

**Region:**

Forsand Kommune, Rogaland

**Vassdrag:**

Lysevassdraget

**Magasiner:**

Strandvatnet (619-636 moh.)  
Breiavatnet (683-658 moh.)  
Nilsebuvatnet (731-717 moh.)  
Lyngsvatnet (686-636 moh.)

**Nedbørsfelt:**

316 km<sup>2</sup>

**Fallhøyde:**

610 meter

**Operatør:**

Lyse Energi

**Innstalert effekt:**

210 MW (6 Pelton turbiner)

**Årsproduksjon:**

1242 GWh

**Turbin:**

Pelton

**Status:**

Bygges en nye kraftstasjon, Lysebotn 2, som med tid skal erstatte Lysebotn 1



Gatebilde

3D

Kart

Kart HD

Flyfoto

Hybrid

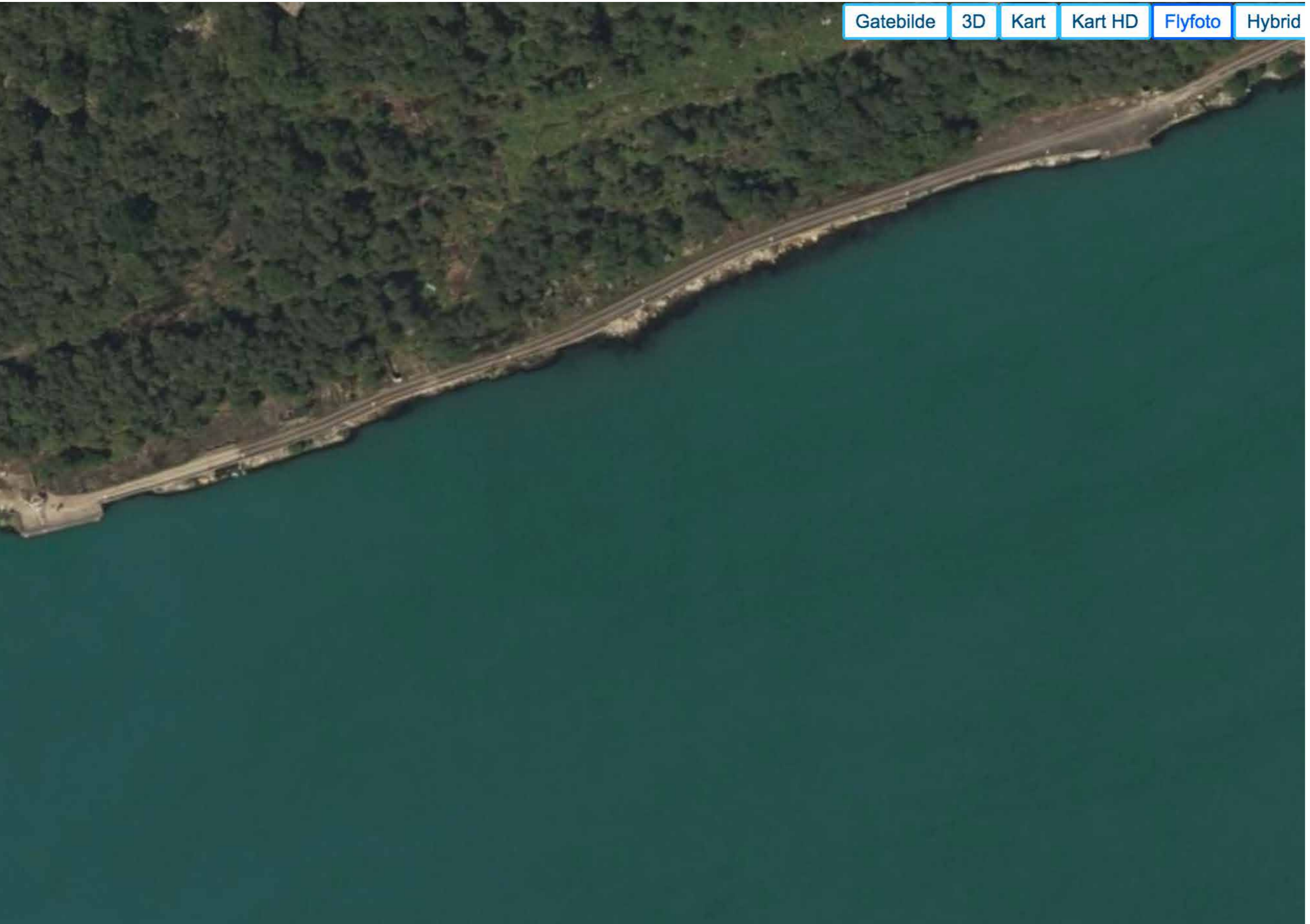

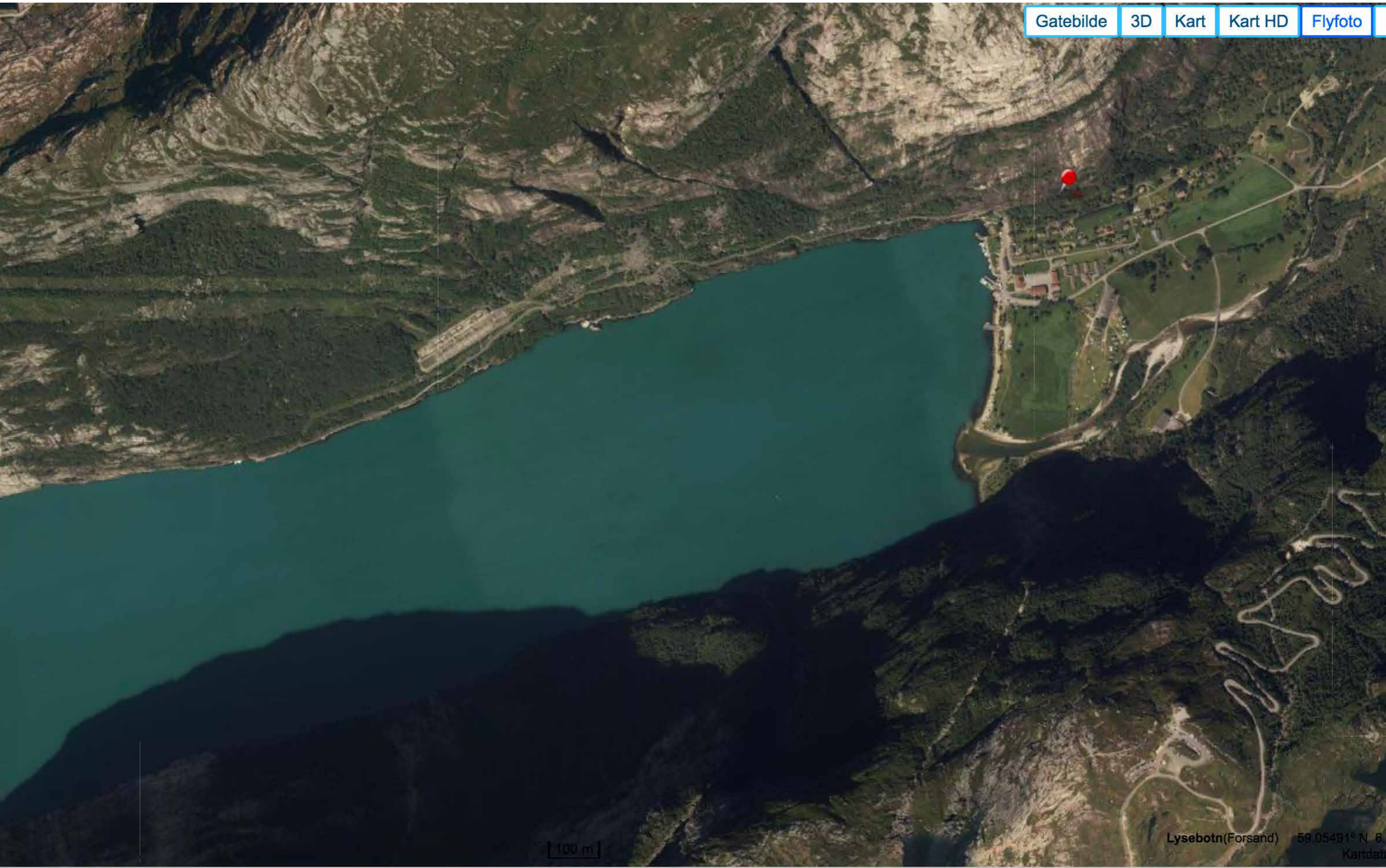

100 m







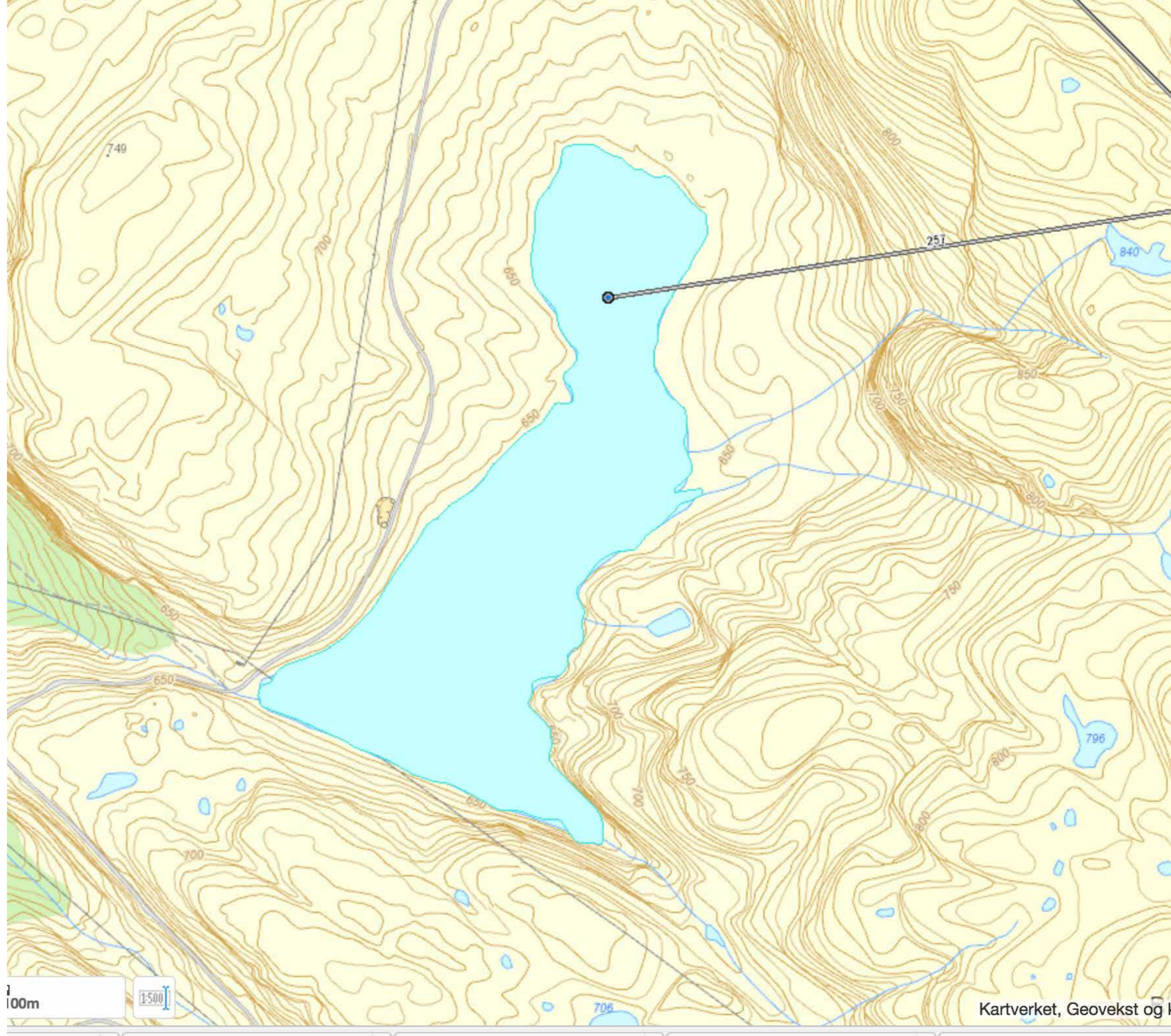

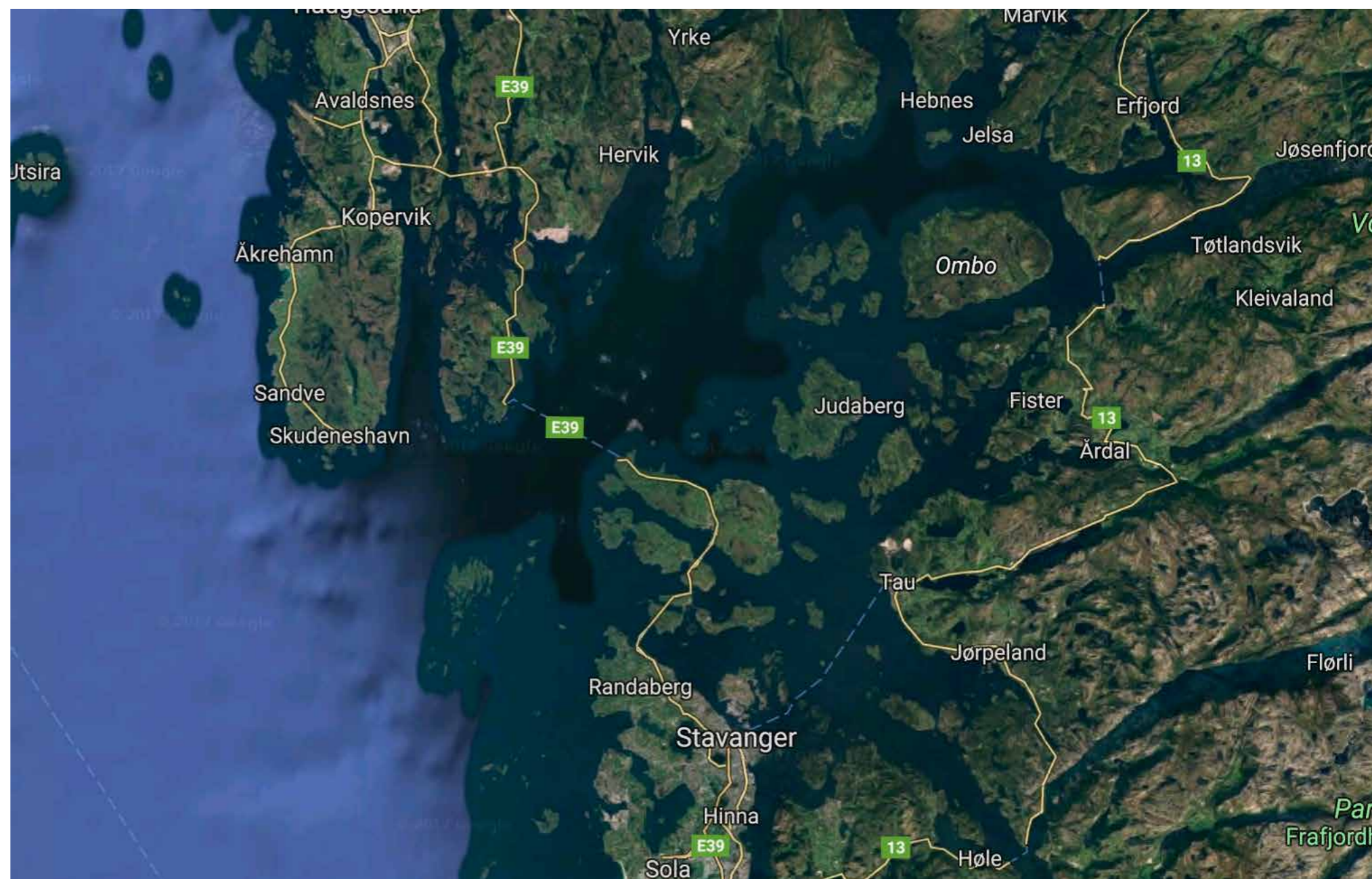



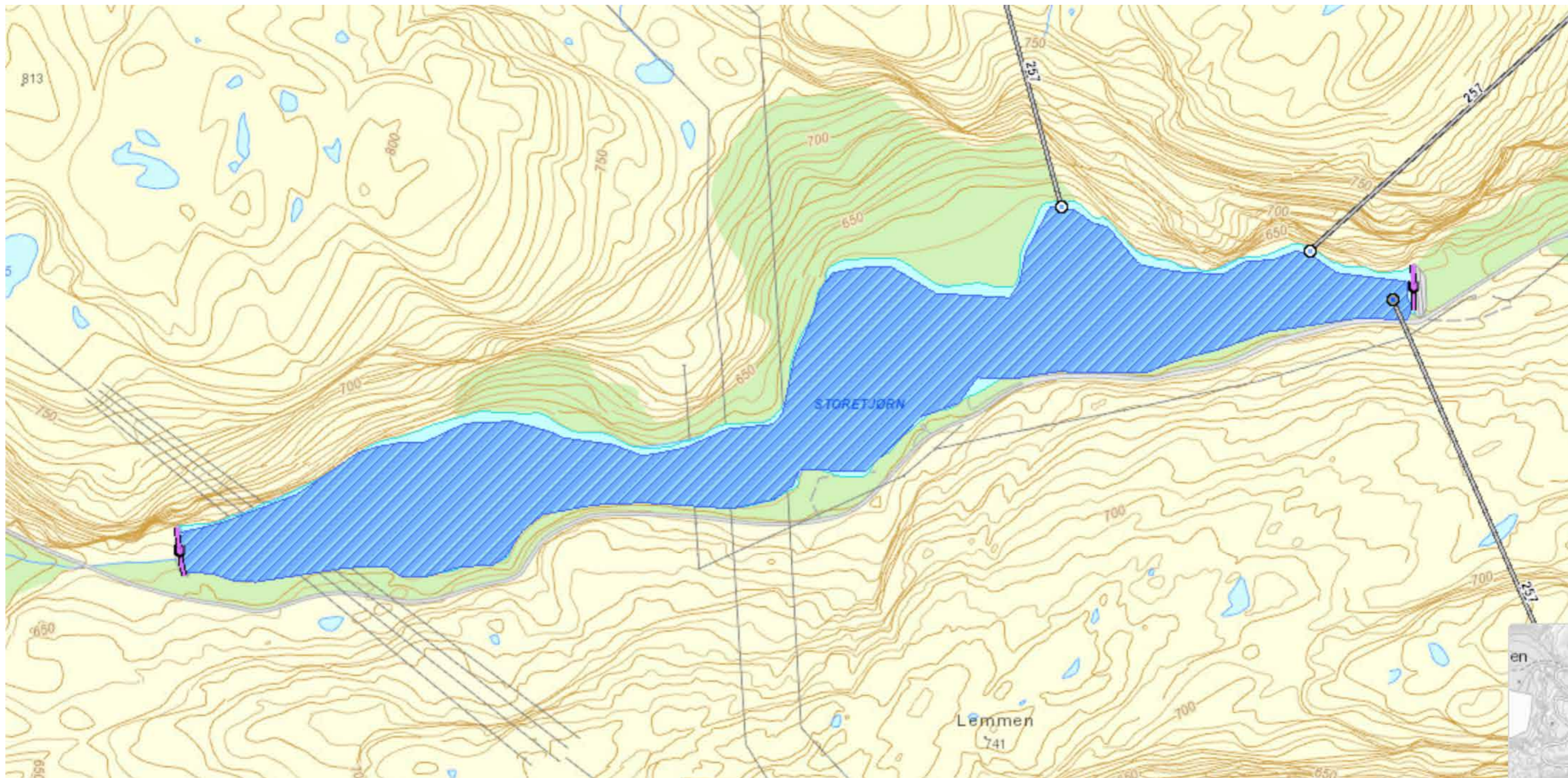







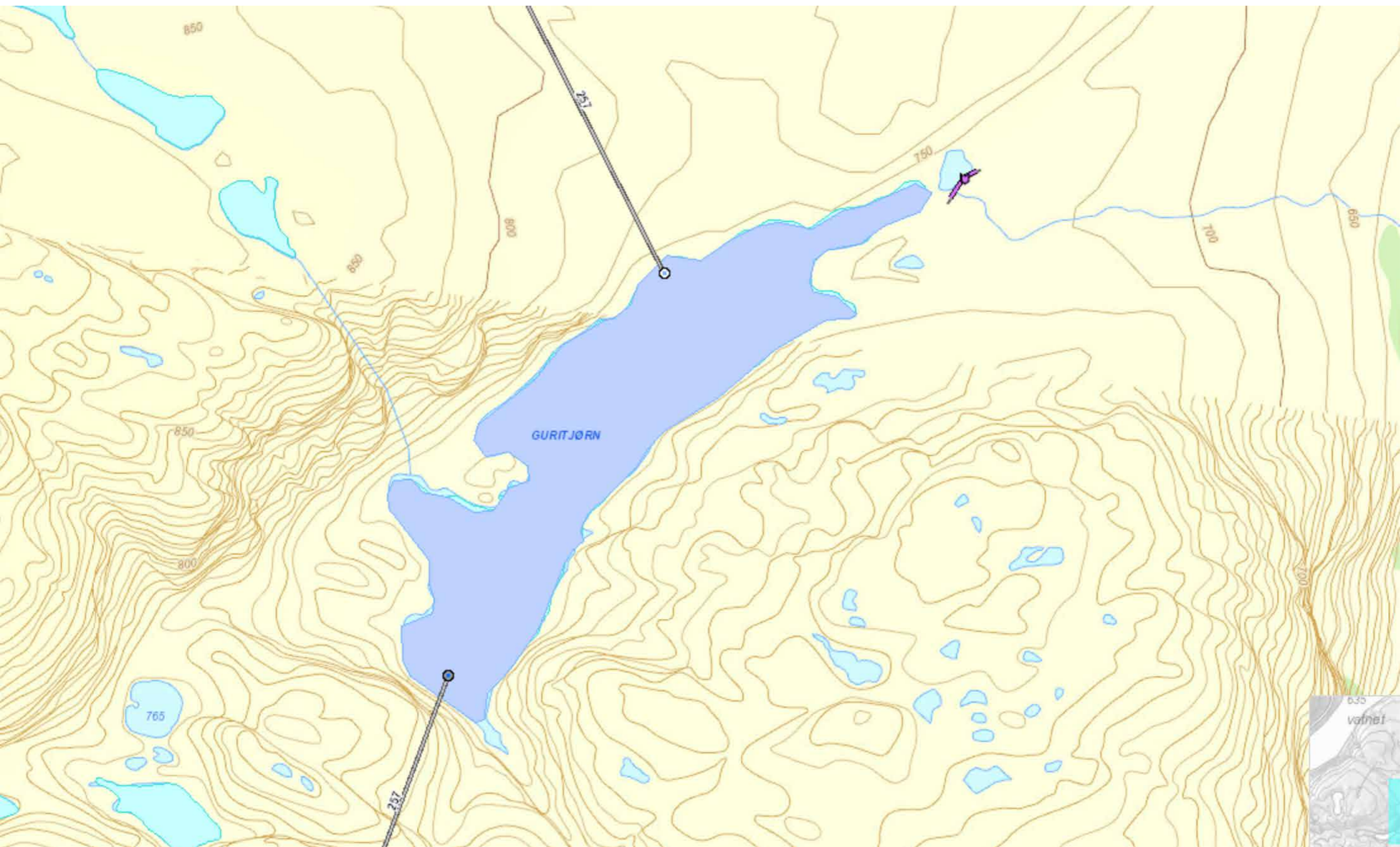

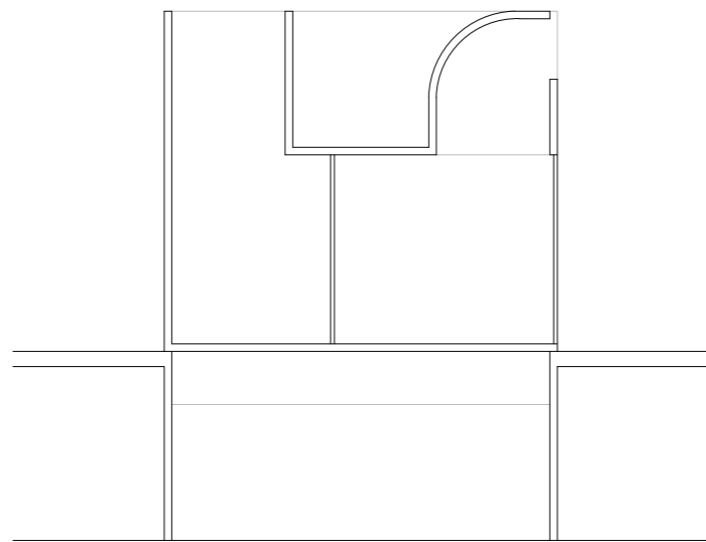
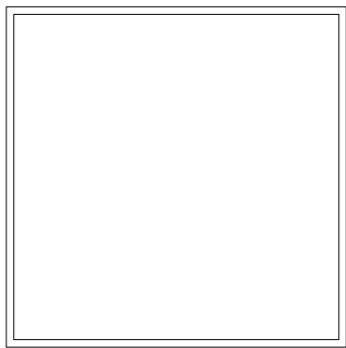
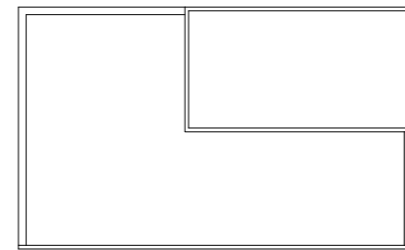
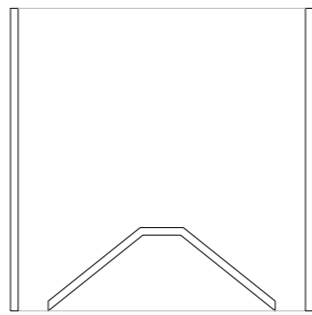
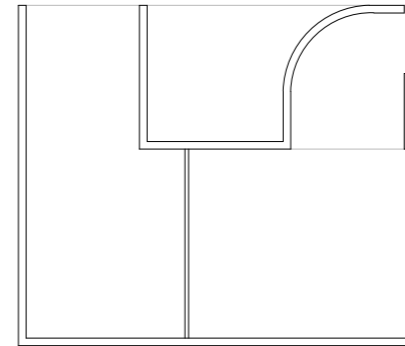
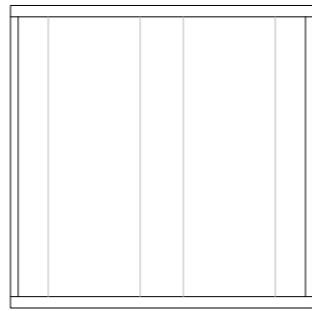
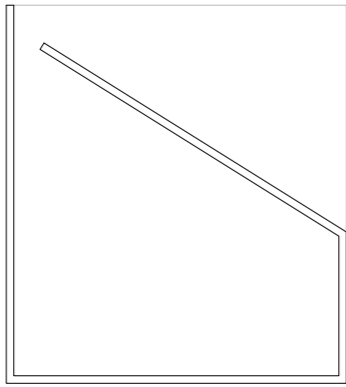

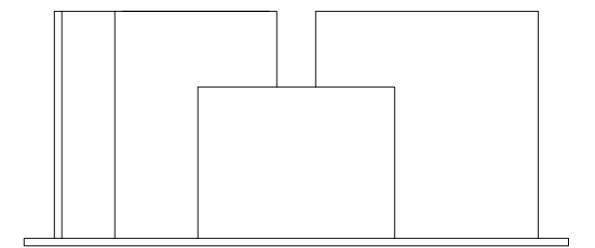
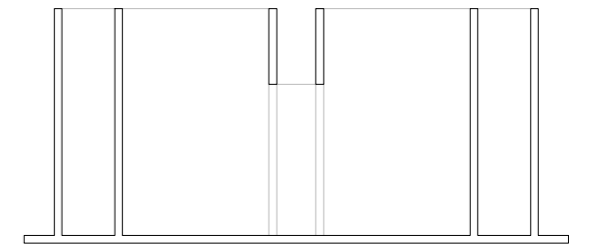
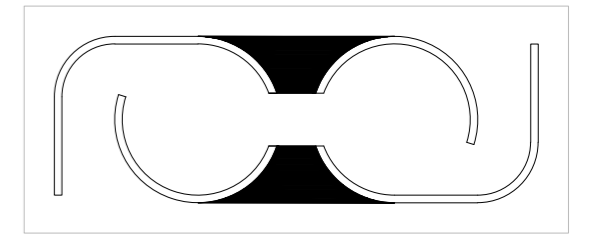
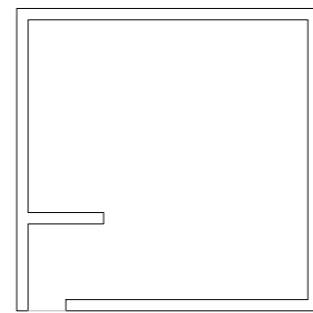
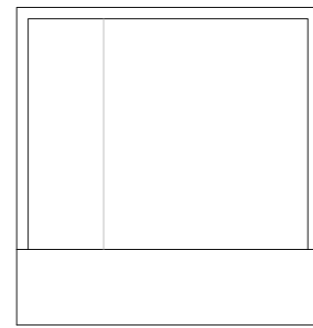
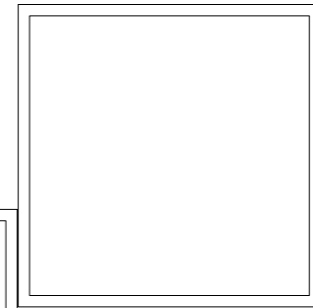
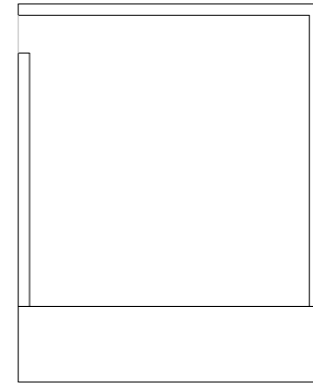
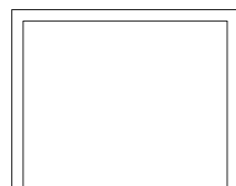
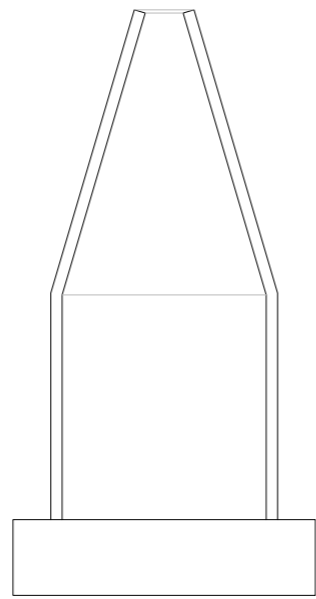
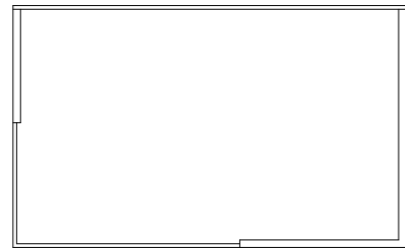
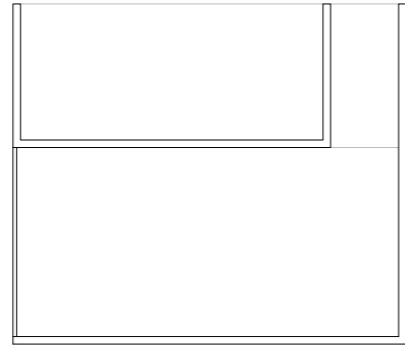
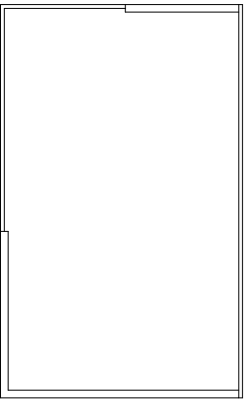
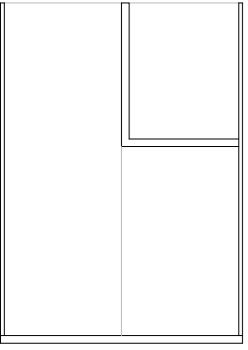

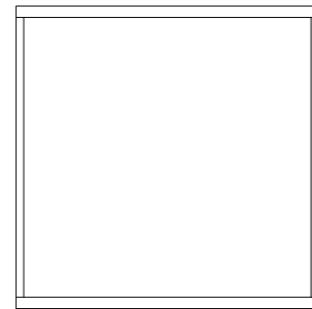
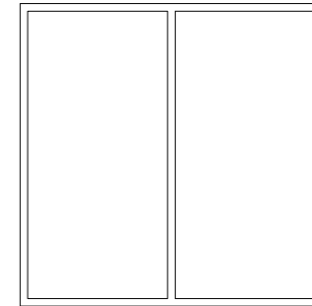
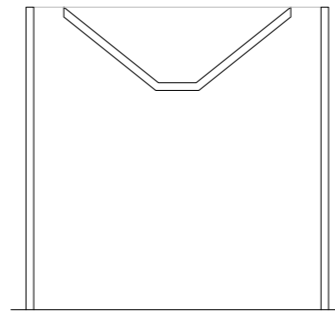
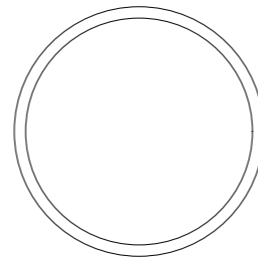
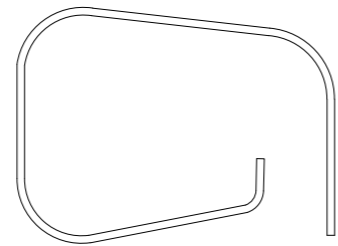
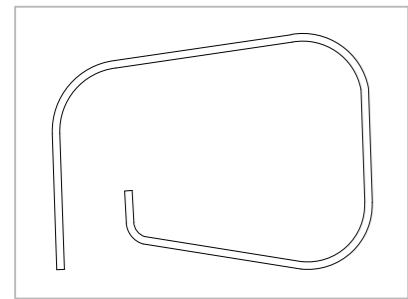
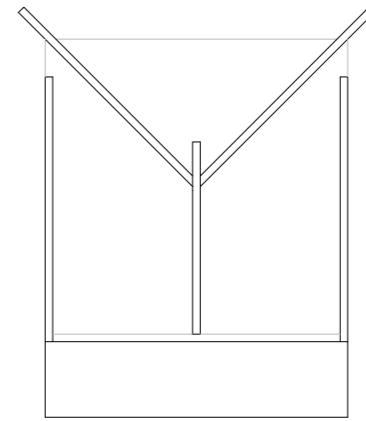
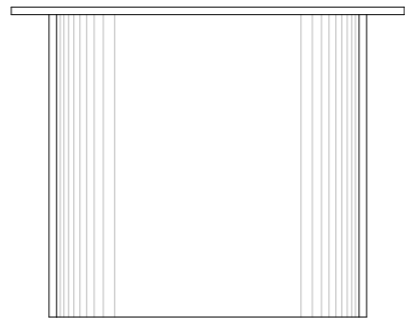
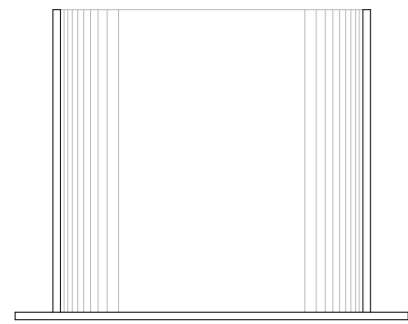



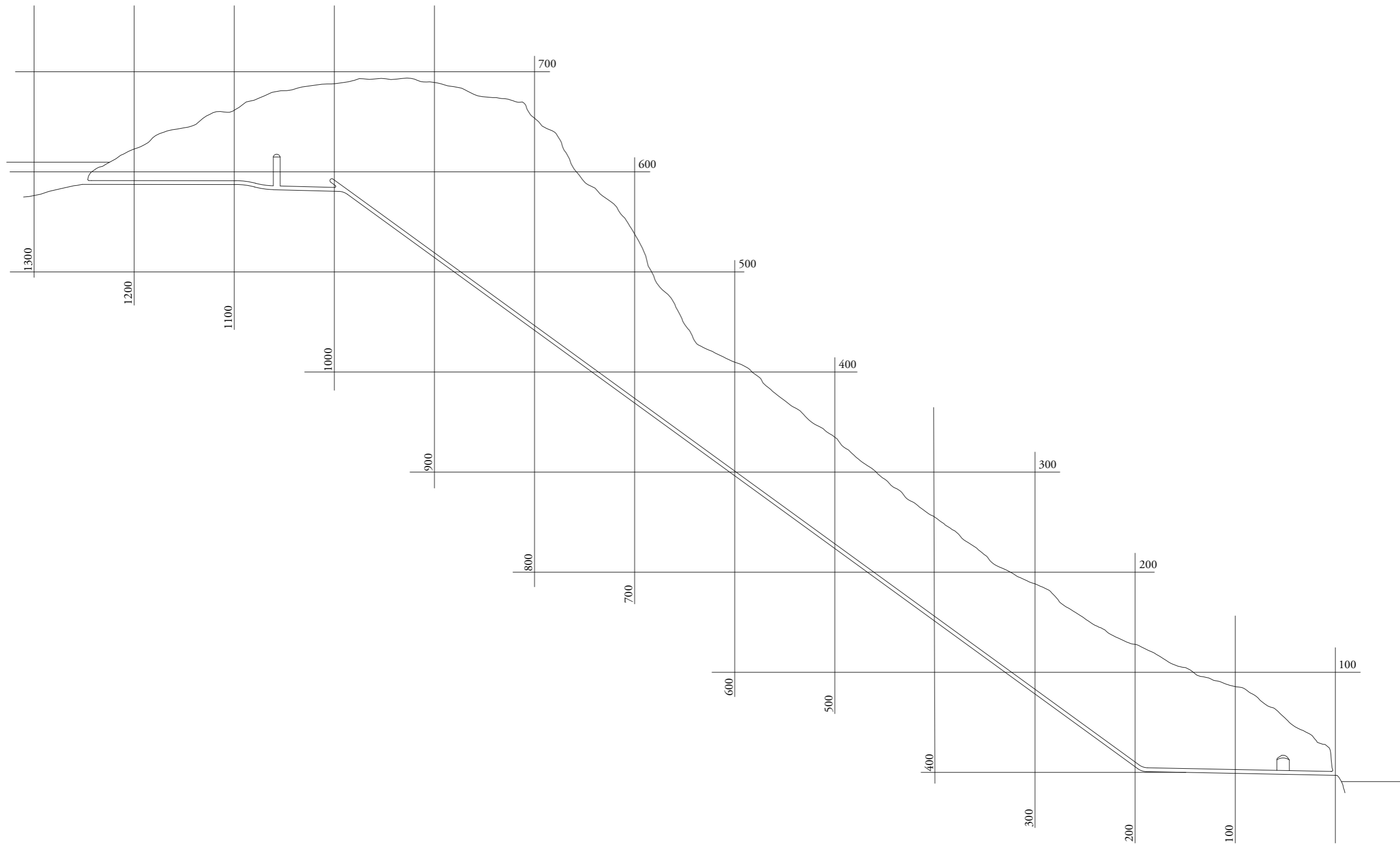

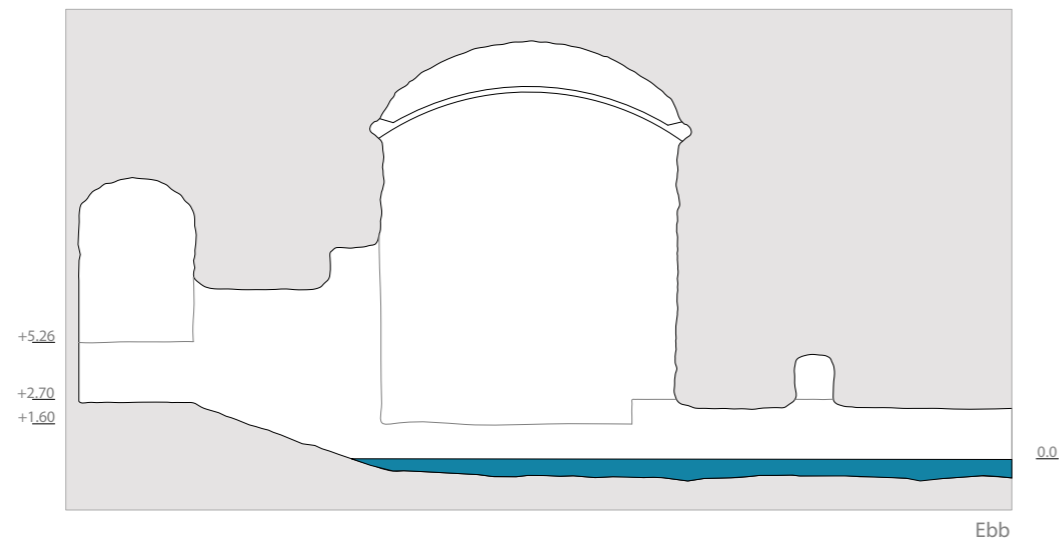
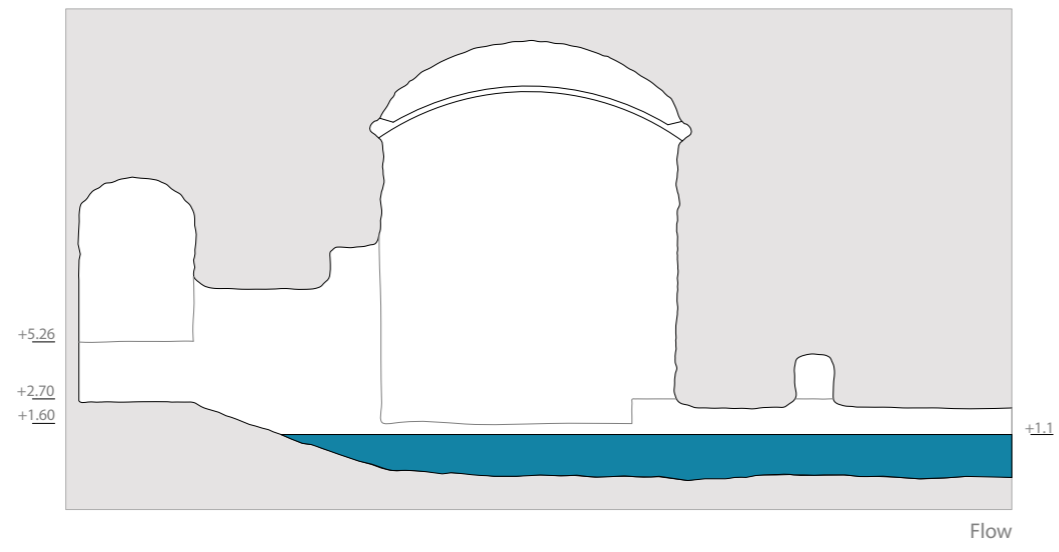

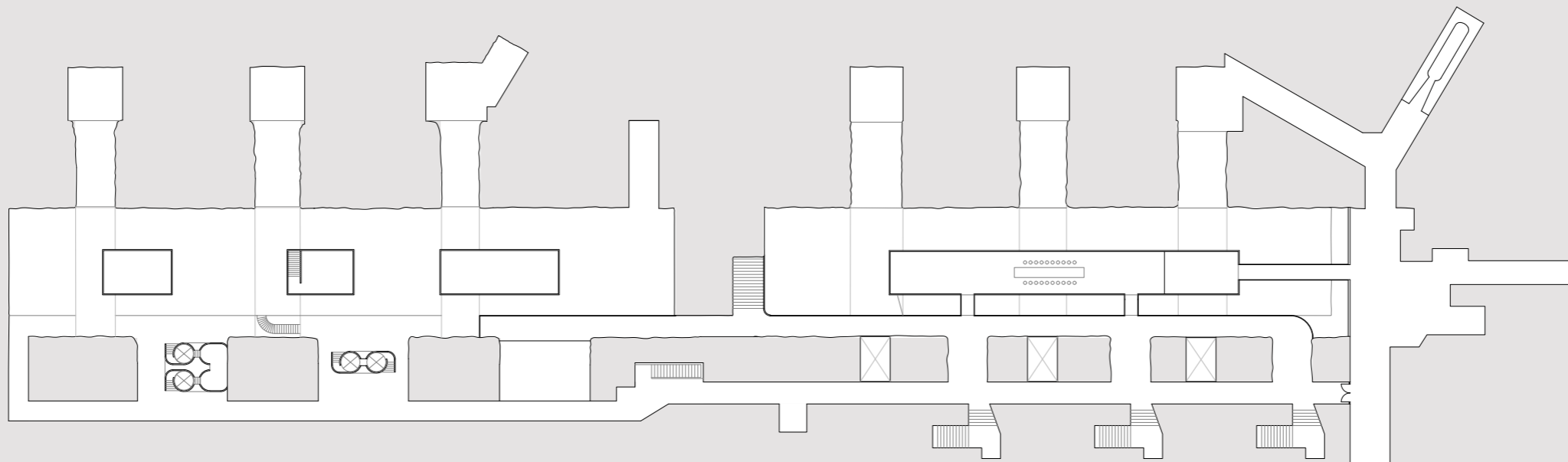

+2.70





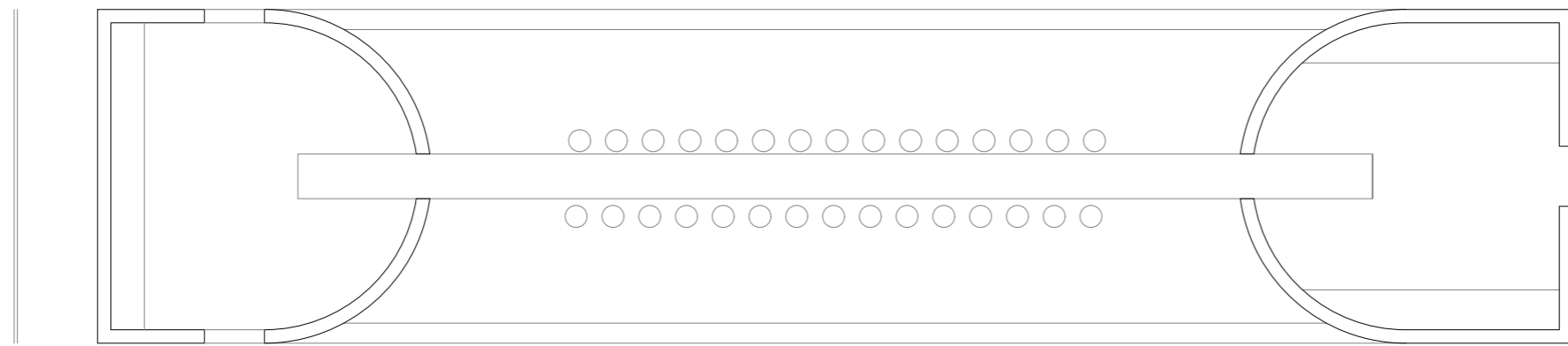
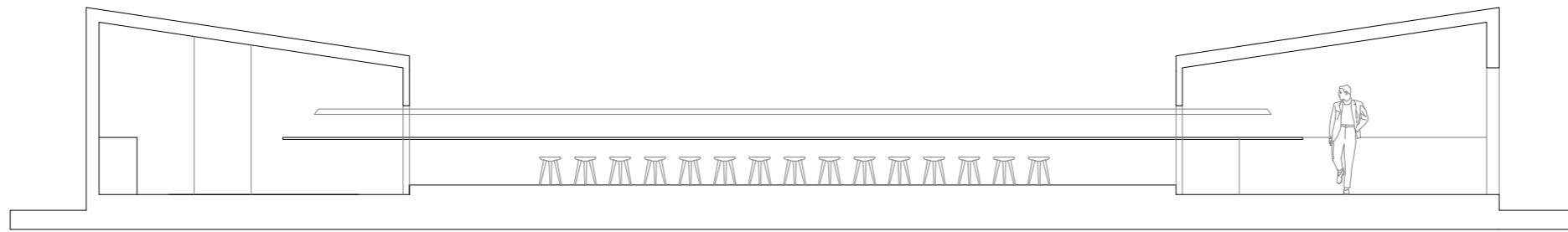

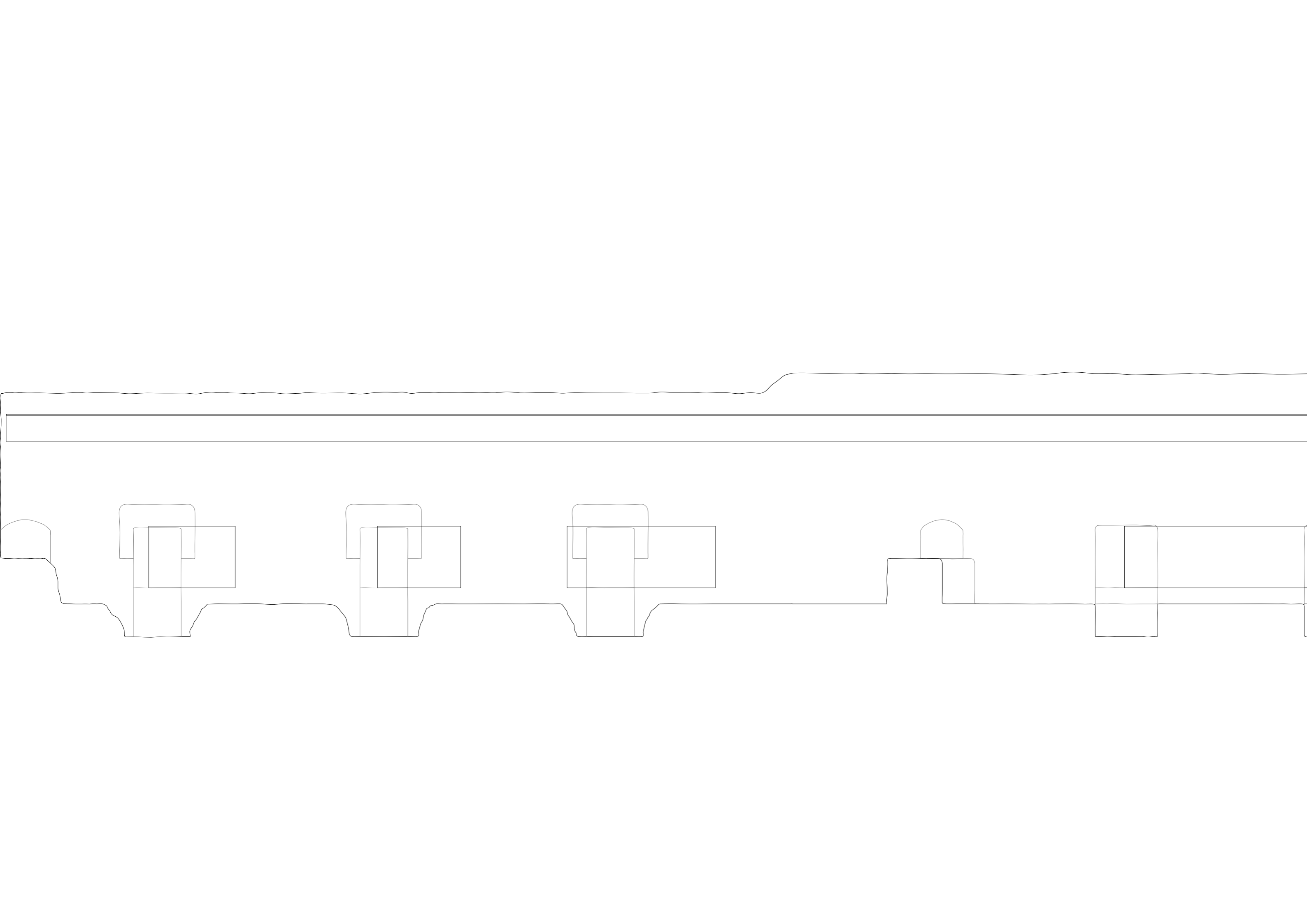

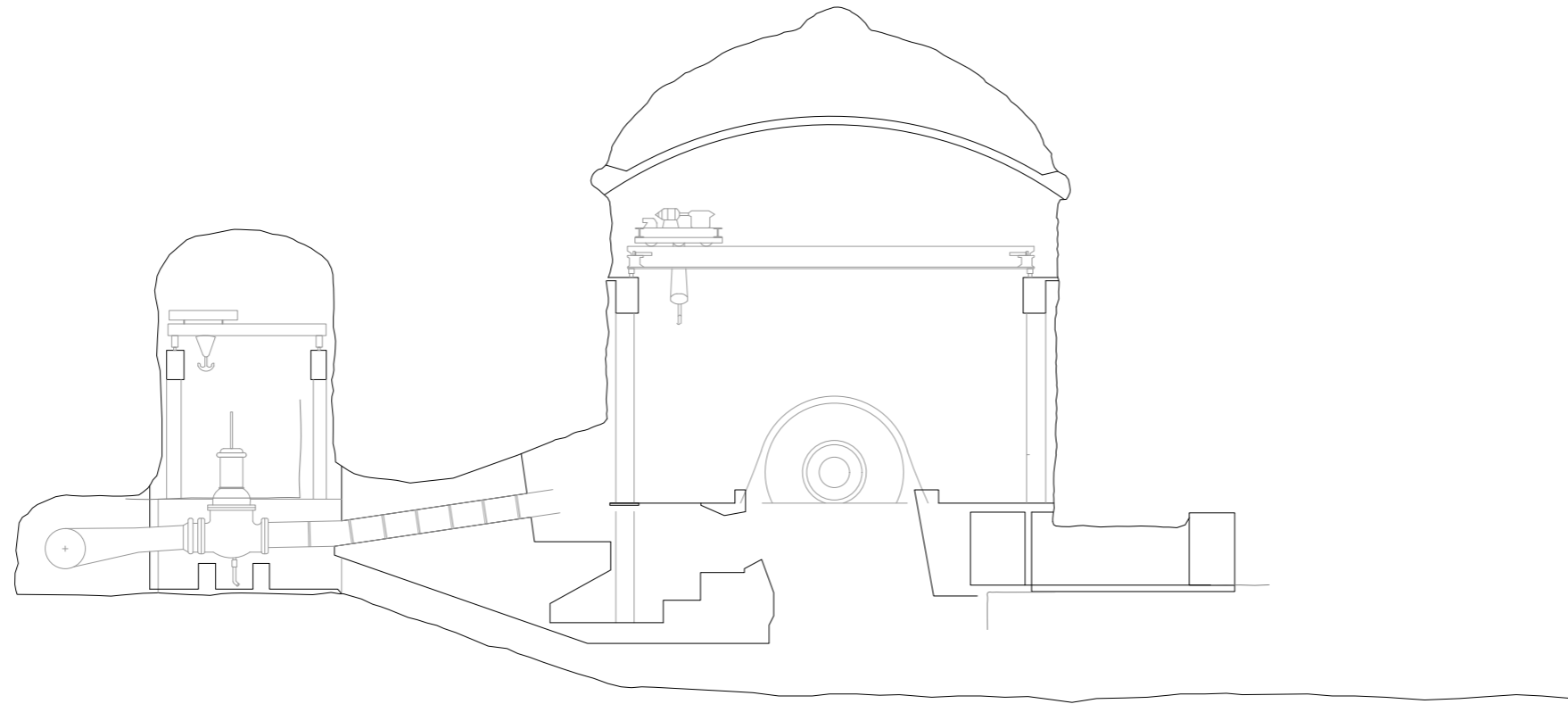

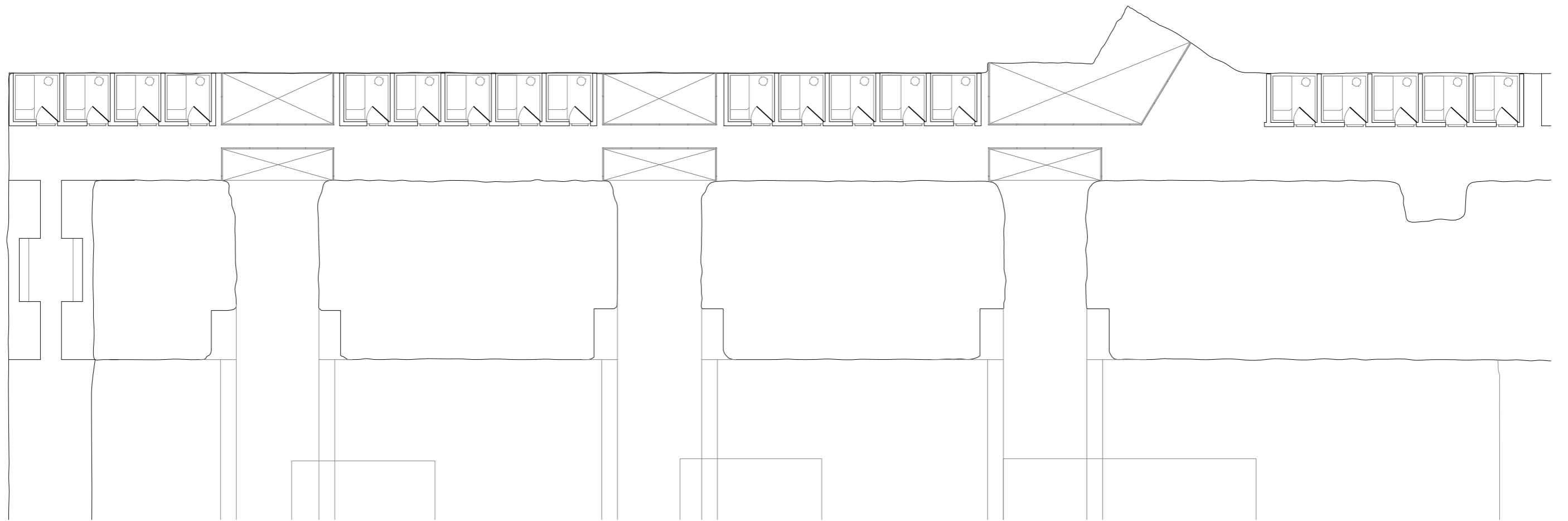

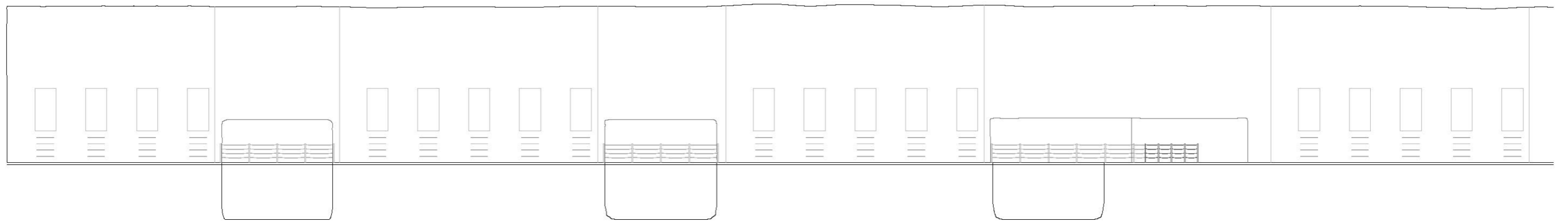

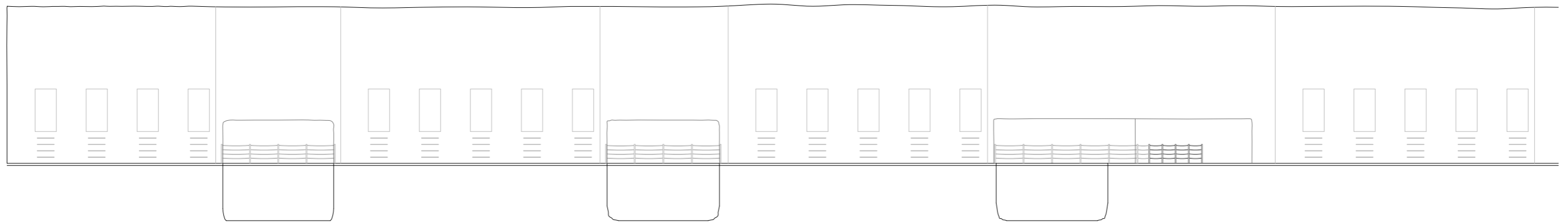
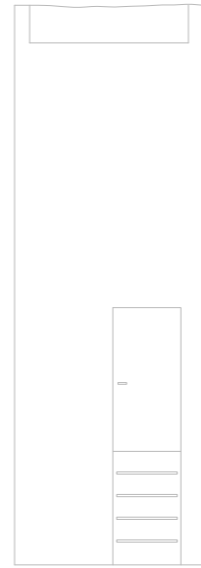
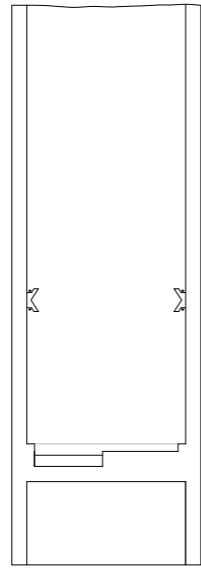
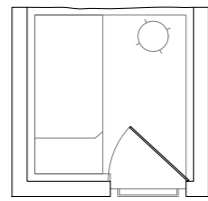





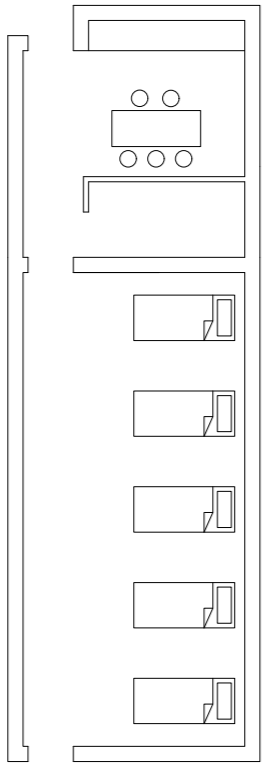

•

