

OIC

Light for compact living

Title: Oic, light for compact living
Name: Tiange Wang
Supervisors: Carsten Oeding Loly
Geir Øxseth
Harald Skulberg
Cooperator: Higzip
School: Oslo school of architecture and design

Light which can support people's need for sufficient light in compact living, at the same time make a design that avoid complicated structures that get in the way in the crowded surroundings of compact spaces.

Catalog

Introduction	5
Methods	8
Research	10
Criteria	29
Concept	32
Ideas and experiment	33
Dimension	51
Proposal	59
Prototype	69
Test and feedback	78
References	80

Introduction

Background

Home

Increasing compact living

Why a compact space?

Urbanization is an unstoppable process in China and the world. When people move to the small space in cities from spacious countryside home, many things are changed. The window become smaller, the trees becomes to concrete buildings while the sunshine cannot pass through. Home become a place for storing, and people can merely find a room for relaxing, studying or working.

From the reseach: Urban areas are growing and will keep growing in the future. The research from Electrolux states "It is projected that by 2050 the Earth's population will rise to 9.7 billion. By then, 67% of the global population will live in cities, creating both challenges and opportunities." (from Electrolux-Report-Compact-Living-Quality-capital space 2016)

From the report of Chinadaily, "Currently the per capita floor space for residents in cities and towns reached 28 square meters, growing at an average rate of one square meter a year since the early 1980s, when the figure was less than eight square meters," said Qi Ji, vice minister of construction. (http://www.chinadaily.com.cn/bizchina/2008-03/17/content_6542889.htm)



Who is living in compact homes in cities in China?

A big amount of people who live in cities especially in first line (Beijing, Shanghai, Guangzhou, Shenzhen), and second line (Hangzhou, Suzhou, Wuhan....) cities are middle class employees. 'McKinsey & Company' predicts that 76% families in cities will become middle class by 2022.

Living in the cities
Middle or high income
child >= 1
decorate homes

small space in cities
afford for better things
more space
presentation

China's Middle Class as Percent of Urban Households

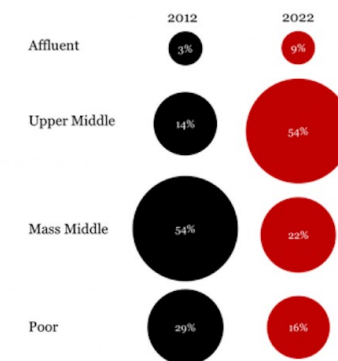

Source: McKinsey & Company
Household incomes:
Affluent: >\$34,000
Upper Middle: \$16,000 - \$34,000
Mass Middle: \$9,000 - \$16,000
Poor: <\$9,000

www.truewealthpublishing.asia

picture and information from McKinsey & Company

Normal living space and compact living space

When we describe home, we used to use bedrooms and living rooms to give basic dimensions of a home. Later we have added more detailed information such as studying room, kitchen and bathroom into the conversation. The function of 'normal' living are detailed and subdivided. People read and focus on work in studying rooms, preparing food in the kitchen, drinking in dining or sofa area. Lounge areas is also seperated from basic functions.

While in compact living, many areas serve not just one function. Simple spaces are merged. For example, living room combined with dining room is very common. In Japan, single space structures are very common and movable walls are added into the space. "One-space living offers the freedom to organise your home to suit the new informality in the way we live and spend time with families and friends, the diversity of modern lifestyles and demand for mutifunctional environment"(The special quality for compact living-By Luke Riggall)

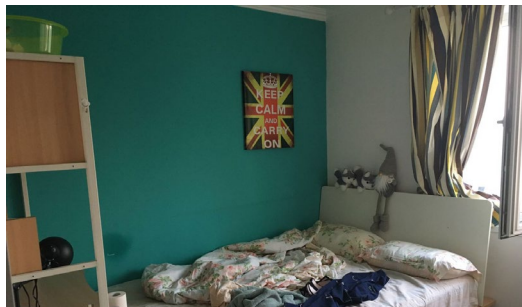

Home is a place where we spend most our time. It is a mixed place where people relax and focus, rest and work. Home evolves with people, starting from being primarily for food preparation and sleeping to now being subdivided with a dining room, reception room, living room and study room. There are many phrases that describe home, such as "There is no place like home" or "home sweet home". When we talk about home there are always different recalls from home: the noise from a window, the sunset coloured kitchen and the smell of the cooking.

When I moved to Denmark for exchange studying, I spent the first night in my new unfurnished empty student apartment. There was nothing in the room. When the pale moonlight came into my empty room, I felt this is not my place. Slowly, I got furniture for my empty room. When my second hand tree floor lamp lit up in the night, the light not only lit up for the room but also brought back memories of home. The moment when we feel we are home at night is not when we open the door with our keys, but when we switch on the light.

Methods

Field research

I went to Higzip's factory during the summer to see the real situation of the factory. I talked with their engineers and gained information about the factory and limits of manufacturing. I visited the product chain to know more about how the products are produced and talked with the head of the factory to discuss what kind of products are good for a factory to produce and sell.

Interviews

I interviewed people who live in compact spaces in big cities to gain knowledge about living conditions, preferences and needs. During the summer vacation I met people who are living in a compact home in Shenzhen, I visited their home where we talked and I observed their living environment.

Case study

As my concept and ideas are to reflect light, I did research about light control and a study of Louis Poulsen's lamp. 'Erco-handbook-of-lighting design' was also a good document for me to understand light control. It introduced basic knowledge of perception-oriented light design.

Mockups and sketches

I did 2D sketches to 3D models to mockup. Fast sketches and fast mockups aim to catch the sparkle of inspirations, and 3D-modelling can detail ideas and structures. 2D sketching is a starting point while 3D-mockups can provide new inspiration and then back to 2D sketches. They are like a circle. Mockups can help designers have a better picture of dimensions and materials.

Prototypes

Prototyping helped me realise the favourite concept and idea, with a prototype it is easy to discuss everything in detail and it helps everyone get into the project. Many modifications were done when I built the prototype. With changeable parts, it is easy and obvious to see modification each time.

Research

interviews, compact
products, activities
at home, partner
information, light
study, floor lamp study

Various compact spaces

extreme example students' dorm room, livingroom, bedroom, diningroom 3 in 1

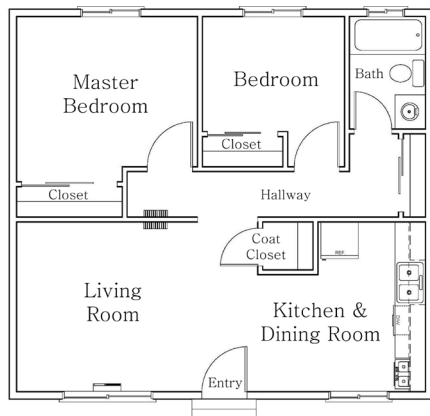

<http://surrpui.net/99996/interesting-2-bedroom-apartment-floor-plans-3d-images-design-inspiration/>

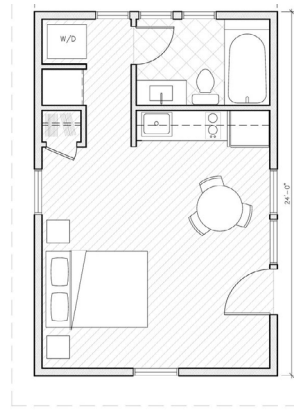

<https://www.supermodulor.com/1-room-house-plans/awesome-image-result-for-1-bedroom-700-sq-ft-house-plans-437-square-feet-1-room-house-plans-pics/>

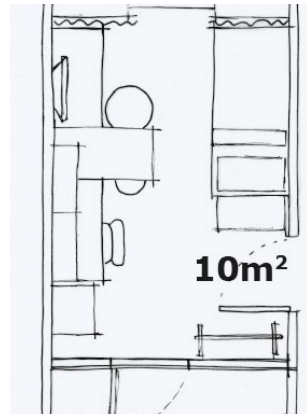

http://www.ikea.com/us/en/catalog/categories/departments/small_storage/roomset/20144_idli04a/

When talking about small compact housing it is important to remember that small housing can't necessarily all be put into the same box of definition or typology. Instead it should be considered that there are several different types of small compact housing, which all differ more or less from each other, either in size, shape, function or practical use etcetera. Which type people choose might depend on many things, and the reasons may also change depending on the user group in question. When one chooses to live in such a small space it is important that the space fits to the wants and needs of the user. **【Brown, 2005; Mitchell, 2014; Richardson, 2011; Kottas, 2014】** Same space could become compact with different numbers of family members.

Interviews



Name: Lei
Location: 1 apartment in Shenzhen
Number: Couple

Interview 1

Lei:

Lei: our apartment is quite dark in the night, we don't need too many light in the evening.

me: why?

Lei: we like the feeling of dim light, it's cozy and comfortable.

Lei: we had an arc lamp beside sofa, but it in the way to sofa, and we don't often reading books at sofa, so we disassembled it.

Lei: we move to this new home 3 years ago, before we live in the centre of Shenzhen. At that time we had a Artemide lamp, while a lot of glare from that lamp in the night, but with the dimmer, the light become comfortable.

Me: with dim light, how could you do table works?

Lei: then we bought the arc lamp which we mentioned before, it good for reading, but now we threw it. By the way, dim light is good for listening to the music.

What do you do at home?

we work at our own working space.

I watch pad at sofa, and dining table. I also watch pad or read book before I sleep.

what kind of lamp do you have for working?

I have a floor working lamp, the flexible structure fits to my table quite well.

my husband has a desk lamp for computer.



Interviews



Name: Bei
Location: 1 apartment in middle of Shenzhen
1 apartment in suburb of Shenzhen(40km)
Number: 2people (Bei and her roommate)

Interview 2

Bei:

What do you do at home in different places?

I do some reading and sleeping at bed room, Ironing clothes at study room, and watching TV, dining, doing sport and casual reading at living room.

Are you satisfying about your lamps at home?

I don't have much to complain about the lamps in my apartment, they are working well, maybe the manufacturing is not so good, some of them already rusted now.

Do you need any new lamps at the moment?

I probably need a floor lamp beside my sofa and the light must be yellow, the ceiling light is too bright for film.

what about your new home?

I think, I also need a floor lamp for my study room in my new home, I just do casual reading there, no desk in the study room.

How about the light in your apartment?

there is not so much difference between daytime and night in my apartment, the natural light here is not very good. I only have 2 hours sunshine just before the sunset.

When you going to buy new things, are you consider different things for different apartment?

the priority of buying things for her small home:

1. Size
- 2.function
- 3.decoration
- 4.others e.g. price

Interviews



Name: Cong
Location: 1 apartment in Beijing
Number: Couple

interview Cong:

What do you do at home in different places?

We watch Tv at living room. We have X-box and some time we play video games on Tv.

What about light in your apartment?

we don't have too many windows, and biggest one is in the bed room. My cousin give me a rocking chair when I married. In the day time I sit close to the window and read papers.

What do you think about lamps in your apartment?

They are bright, everything is clear in my apartment.

Do you need to do focus job at home?

Not really, we did it in the lab, when I back home, we just want to relax.

Random interviews

What kind of activities do you have in your student dorm?

I use my computer alot, and I am drawing illustrations when I am free, I love watching movies, I even have a small projector for film at home.

How would you change your light at home for these activities?

I have ceiling lamp, but I love my working lamp, it is good for table and computer works, when I want to watch films I just turn the light to the wall, the dimmed light is really good for film and also bright enough for funding the way to toilet.

What about sleeping time?

Well first, turn of the ceiling light, second dim my bedside light, third throw my phone to the bedside table.

Hey I saw you doing paper works at dining table, can you talk about it?

well, I am tired of doing things in my room, and the light here is good both for reading and computer works, and the table is huge

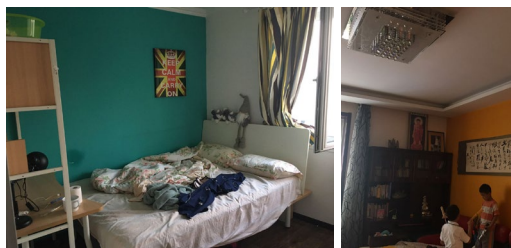
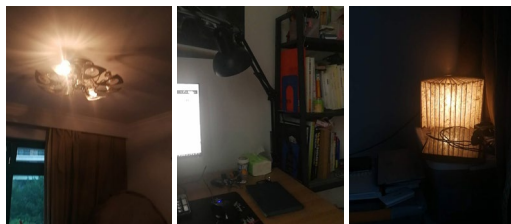

Observations and Insight

Kitchen & Dining Room Lighting Plan

Symbol	Luminaire Type	Lamp	Qty	Watt	Total Watt	Efficient (lm/W)
⊕	Linear suspended pendant	Integrated LED	2	26	52	91
⊖	Recessed downlight	GU-24 base LED	2	16	32	67
⊖	Undercabinet	Integrated LED	11	8.5	93.5	91
⊖	Ceiling fan with light kit	Integrated LED	1	20	20	75
⊖	Wall sconce	GU-24 base LED	5	9.7	48.5	93

CONTROLS: Dimmer switch, Dimmer switch with vacancy sensor

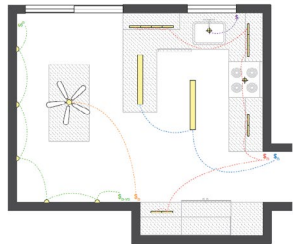

RESIDENTIAL LIGHTING 2013 TITLE 24, PART 6
A guide to meeting, or exceeding,
California's 2013 Building Energy Efficiency Standards DEVELOPED BY THE CALIFORNIA LIGHTING
TECHNOLOGY CENTER, UC DAVIS

Large Kitchen Lighting Plan

Symbol	Luminaire Type	Lamp	Qty	Watt	Total Watt	Efficient (lm/W)
⊖	Recessed downlight	GU-24 base LED	3	12	36	67
⊖	Pendant	Integrated LED	2	16	32	60
⊖	Undercabinet	Integrated LED	11	8.5	93.5	91

CONTROLS: Dimmer switch with vacancy sensor

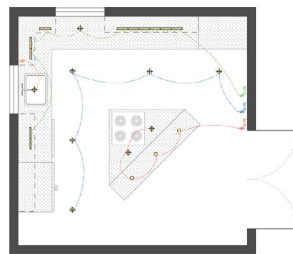

From research, in many homes, there is just one ambient ceiling light for all the activities beneath it, such as living room, and dining room. People don't complain much about light. When you keep asking the question about what do you need? Some talk about that they miss a light for reading around sofa, or for film. For many people, basic light is enough for basic life, good light is not very necessary for home. While light do act a very important role in people's life. People working and living in different spaces with various light. Light impact people's emotions, and it changes the feeling of surroundings.

Many recommendations about interior light at home recommend use different light for different activities, the plan from the paper use spotlight to support focus task at home. Ambient-task light system is needed at home.

Bad light condition is an unconscious problem in a compact home. Light system at home is complex. A good living place have different types of light to create an environment for different purpose and activities.

How does everything happen in compact room?

After the interview I wondered what kind of activities happen and how do they happen at home. When talking with people and checking documentations and later analysis I got some insight. Compact spaces are highly multifunctional, customized, and combined spaces.

Everyday activities happen in the same space but supported by different products instead of taking place in specific areas with specific products. So the function of the room is defined by the product, used at the moment and the more compact the space is, the more obvious this characteristic.

Japanese is really good at living in compact spaces, *When it comes to compact living, two approaches are fundamental to the success of the space; it should be predominantly a 'single space' and it must work effectively for 'multiple uses'. Compact living has since shown it is capable of dealing with these issues using other, secondary approaches such as 'zoning and division', a 'variation in spacial sensations', a 'reduction to essentials', 'integration and storage' as well as 'lightning' techniques. (the spacial quality for compact place p38)*

Spaces of multiple functions, or multifunctional, allow for many different uses to work together within the same, shared room. This enables each use to be defined by the softer elements such as furniture, elements which can be changed and adapted by the occupant much easier and efficiently. The space becomes more flexible; being able to change as and when required, as well as being more versatile; remaining relevant when requirements shift. Multi-functionality allows the maximum space to be used at all times to make the most of what is available. a 'variation in spacial sensations', a 'reduction to essentials', 'integration and storage' as well as 'lightning' techniques. (the spacial quality for compact place p38)

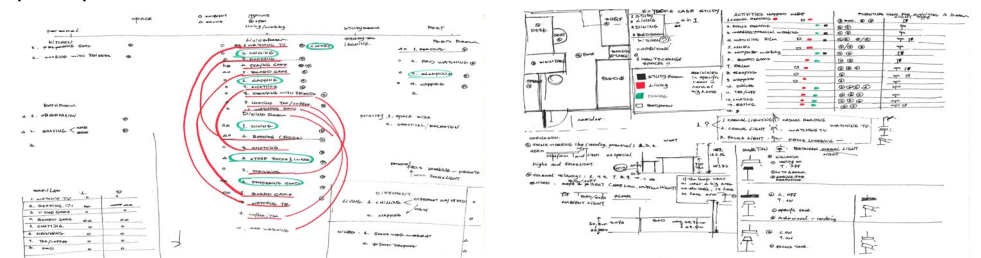

Different activities in two main areas at home -dining and Living

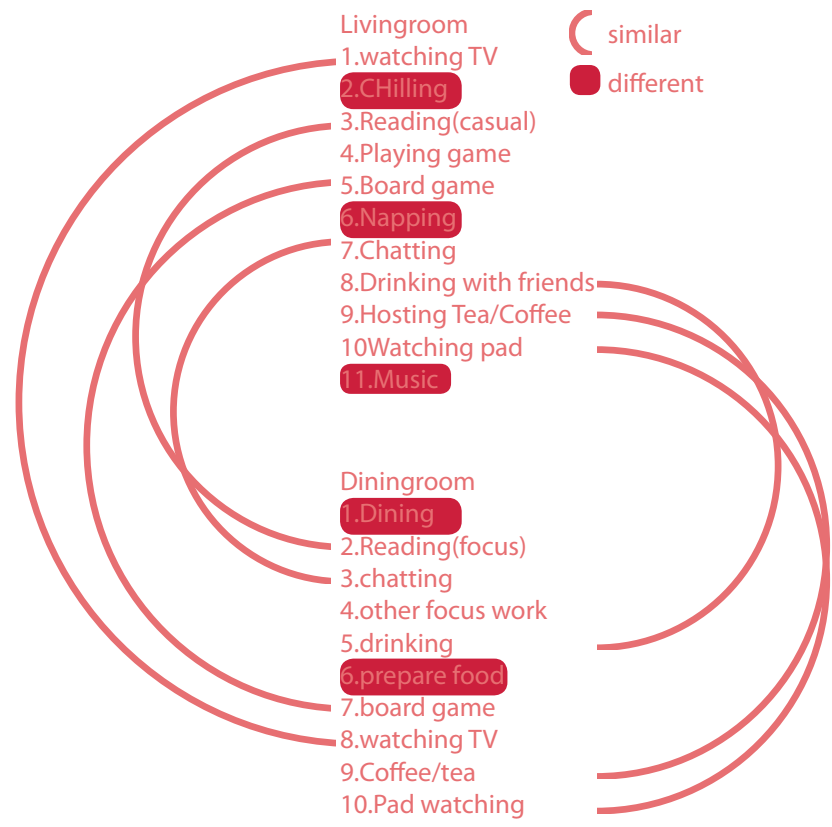
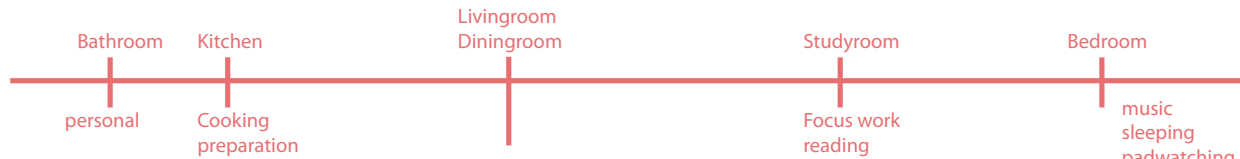

activities	surroundings	light	light how
1 watching TV	sofa, chair, tea/coffee table, Tv	soft	wall lamp, ceiling lamp, floor lamp, table mood light
2 rest/chill	sofa, daybed, loungechair, tea/coffee table	soft	wall lamp, ceiling lamp, floor lamp, table mood light
3 chill reading	sofa, daybed, loungechair, chair	focus	floor lamp, table lamp on side table, focus from ceiling, wall lamp
4 focus reading	chair(bookshelf, table), dining table(chair, shelf), sofa, (coffee table, side table), desk(chair, window)	focus	ceiling lamp, dining lamp, floor lamp, table lamp on side table, wall lamp, table lamp
5 video game/film	sofa, Tv (sofa, coffee table, chair, shelf, wall, desk/computer/chair, window stool, book shelf), dining table, laptop(chair, shelf)	soft	floor lamp, table lamp, ceiling lamp
6 Board game	Tea/coffee table, tv, chair, shelf, Tv, stool, dining table(chair, shelf), floor	focus	table lamp, ceiling lamp, table lamp, ceiling lamp
7 napping	lounge chair, sofa, bed (bedside table, tea table)	soft	wall lamp, floor lamp, wall lamp, floor lamp, ceiling lamp, bedside, wait table lamp
8 chat(sofa)	sofa, coffee table, side table, sofa, chair, TV, shelf, wall		table lamp, floor lamp, wall lamp, ceiling lamp
9 chat (dining)	dining table, chair, shelf	soft	ceiling lamp, candle, table lamp
10 hosting coffee/tea (sofa)	coffee table, side table, sofa, chair, TV, shelf, wall	soft	table lamp, floor lamp, wall lamp, ceiling lamp
11 hosting coffee/tea (dining)	dining table, chair, shelf	soft	ceiling lamp, candle, table lamp
12 drinking with friends(sofa)	sofa, coffee table, side table, sofa, chair, TV, shelf, wall	soft	table lamp, floor lamp, wall lamp, ceiling lamp
13 drinking with friends(dining)	dining table, chair, shelf	soft	ceiling lamp, candle, table lamp
14 watching pad	sofa, dining table, bed, chair	soft	floor lamp, ceiling lamp, wall lamp, ceiling lamp, table, bedside
15 dining	dining table (chair, shelf, table), sofa/coffee table, sofa, chair	focus, soft	ceiling lamp, floor lamp, ceiling lamp, wall lamp
16 other focus work/craft	dining table, chair, table, shelf, study room(chair, table, shelf)	focus	ceiling lamp, table lamp
17 computer work	dining table, sofa, study room	focus(with paper work), soft(without paper work)	table floor, floor table, ceiling lamp
18 prepare food	dining table, kitchen	focus	ceiling lamp

light	surroundings	activities
floor lamp	focus light	reading/chill, focus, board games, computer works
		Tv watching, rest/chill, chill reading, video games, napping, chatting, pad watching, dining on sofa, computer work
	soft light	sofa, lounge chair, daybed, chair table, desk, dining table, sofa, study room
wall lamp	soft	watching TV, chill/rest, chill reading, video games, napping, chatting, drinking/host, pad, dining
	focus	Desk, spot light
table lamp	soft	watching TV, mood rest, chill(mood), video game(mood), chatting(mood), watching pad, dining(mood), computer work, reading, board game, computer work, craft work
	focus	sofa, side tv, sofa, lounge chair, daybed, chair, sofa, desk, dining table, sofa, side, Tv, side dining table, desk, sofa, coffee table, dining table, dining table, shelf, desk, dining table, bedside table, sofa, dining table, desk, working platform, floor tea table, dining table, desk dining table, sofa

An analysis of different activities, light condition, furnitures in the environment

Things in compact living

Products work in compact spaces, while products which are designed for compact living work better. Products and furniture in compact living are flexible. Utility is the most important consideration. Multifunctional and customized design are the base of compact living. While multifunctionality is not to combine many random functions. It is about maximizing utility based on the structures and needs such as shelf from MUJI.

Dimension is very important for compact living. Peek lamp by Jonas Wagell is considered the dimension in compact living. Flat or slim products are preferred, in many cases only two direction occupation have more tolerance in spaces. many design for compact living also focus on the corner and unused places.

Small space is about organize multifunctional, and relationship with surroundings.

Organize products from Muji shows great potential of organization. Geometric outlines make products get along with each other easier. Transformation give a single project potential to be used in different ways. Good relationship with other products is good for storing, fully use surroundings is main part for compact living.

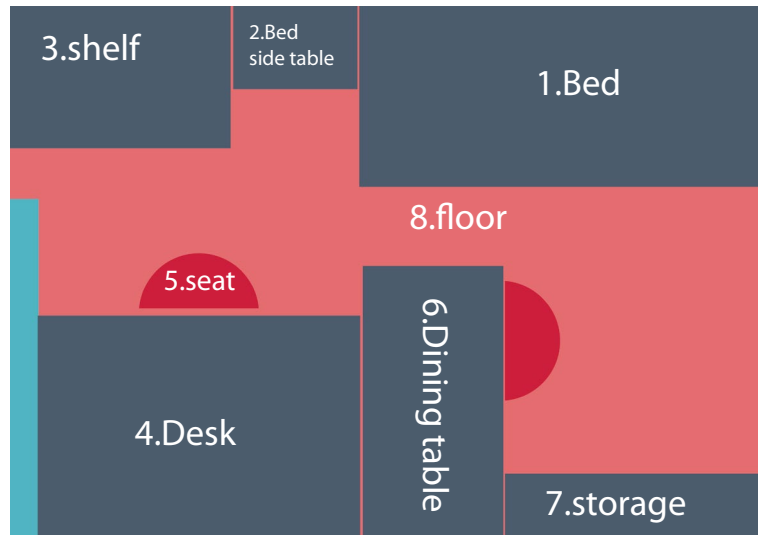

- Studyroom
- livingroom
- diningroom
- Bedroom
- casual task light
- focus light
- casual light

Conclusion:
Compact spaces are highly multifunctional, customized, and combined spaces. Function of the room is defined by the product, used at the moment.

Activities happen here

1.casual reading			1 4 5
2.focus reading			4 5
3.practical working			4 5
4.watching film			4 6 1 5
5.music			1 5 8
6.computer working			4 5
7.Board game			4 8
8.relax			1 4 8
9.sleeping			1
10.napping			1
11.drinking			1 4 5 6
12.Tea/Coffee			1 2 6
13.Chatting			1 5 6
14.eating			5 6

Furnitures and lights are used for activities in Dorm

- casual task light
- focus light
- focus light
- casual task light
- casual light
- casual light
- casual task light
- casual task light
- casual task light
- focus light
- casual light
- casual light
- casual light
- casual light
- casual light
- focus light
- casual light

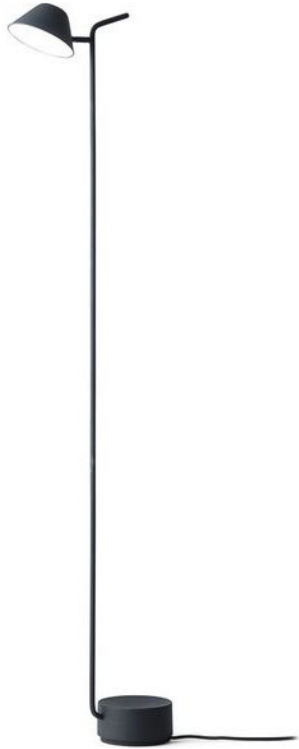

peek floor lamp by Jonas Wagell for Menu



shelf from MUJI



storage product from MUJI



<http://www.apartmenttherapy.com/our-favorite-multitasking-furniture-for-small-spaces-224215?crlf.pid=camp.g10DlzeTpEAz>

Partner information

Higzip is a Chinese hardware factory who manufacture metal and plastic. Their main manufacturing craft is punching, bending, trimming, CNC, tube bending, and plastic injection. During summer, I went to the factory talked and worked with engineers and workers to know the limits of manufacturing and also the possibilities about their product chain. At that moment, one of the product which they were producing HÅRTE LED work lamp for Ikea.

The factory changed their developing direction in the late of 2017. Funds was invested in Lithium battery developing. Battery office was set up. It is going to be a battery factory in the future. Although the factory changed their area, they still give precious feedback for my project.



HÅRTE lamp from Ikea

How would you sell product in the future?

we can sale everything on internet. It is very easy to launch a online shop to sell product. we prefer Amazon, the platform is good, we don't need to rent a real shop, and we can start the business really fast.

What kind of product do you prefer, the product are produced totally by the factory or the product which contains the parts which have to be bought from the product chain?

We can do many things, while we are also limited by our machines. If it is good concept and Idea, we can use our product chain to realize it, we don't need to be limited by our machines.

what is the advantage of online business.

- 1, Customize is presented very well by online shop. Customers can choose exactly what they need from online.
- 2, Less stakeholders, factories can also be the retailer to sell product to customers.
- 3, Fast, feedback can be receive direct and fast. Decisions from factories can be made fast.

Ideas

Modular design, system of products, for example storage system from STRING Furniture. The storage system is made by many small pieces, and each one is both easy to produce and sell.

Core products and accessories, for example Gopro. A core product which cost most of value of products, and many flexible choice and options which can help core products fits to different situations.

Flat package, it is easier to deliver and cost less with flat package



picture from <https://string.se/#>

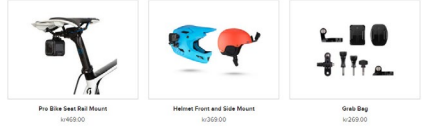

picture from <https://shop.gopro.com/EMEA/mounts+accessories/>

LED

The world is building on the classic and challenges. The incandescent lamp was invented 1879 by Thomas Edison, the shape stayed more or less the same until Halogen light came out with the smaller and more efficient Halogen light and later comes LED evolution. LED extend light source lifespan. Incandescent light bulb only has 1000 hours life, while 50000 hours for LED. This give opportunity to build LED in the structure, which can decrease the size of the lamp, and it can fits to more complicated situations. Now the LED gives more possibilities for the future light design, light bulb could look like the traditional Incandescent lamp or can be different from traditional lamps.

Materials and limits

Lamps are probably the products which are not limited by materials. Materials such as metal, clay, ceramics which are not transparent or translucent can become the reflector of the lamp. Materials like textile, glass, plastic which are translucent or even transparent, can become the diffuser of a lamp. All those materials can be part of a lamp in different design. My partner is mainly a hardware producer and plastic injection producer, so that the limit of the lamps design will mainly focus on these two materials.

Plastic reflectors are reasonably low-priced, but can only take a limited thermal load and are therefore not so robust as aluminium reflectors, whose highly resist antanodized coating provides mechanical protection and can be subjected to high temperatures. In the case of spherical reflectors the light emitted by a lamp located at the focal point of the sphere is reflected to this focal point. . (Handbook of Lighting Design By Rüdiger Ganslandt Harald Hofmann)

Important Insight from early research

Light condition

Compact spaces in cities often don't have good natural light in the daytime, furnished interior sometime don't have good light conditions at night.

Second light

People need different light for activities at home, while there is just one light for all the events.

Dimension

When people consider products for their compact home, size is the most important thing.

Product for compact living

product which is good for compact living, should be well organized itself. It should easy to get along with and utilize surroundings. Geometric shape is simple and easy to be organized.

Customized

Each compact space has its own task, customize is the good strategy for users to solve their own task. Simple and flexible is good for manufacture to enrich product line based on exist products.

Materials and limits

My partner is mainly a hardware producer and plastic injection producer, so that the limit of the lamps design will mainly focus on these two materials.

Flexible

System or modular products are easier for product developing and selling

light research, indirect
and direct light, floor
lamps, access to space,
light control

Light research

Impression with perception-oriented design. Three basic lights are ambient light task light and accent lighting which was described as ambient light, focal glow and play of brilliance by Richard Kelly. All three-light act specific role in our living surrounding. A good environment should have different layers of light which offers different information. Ambient light is the first light for basic lighting, it offers enough light for moving in the space, the standards light level for the space like living room is 50 lux in the night . Task light is for specific task which is happening in the space, it can offer different support for different task, and different task have different light level preference. such as casual reading is 150 lux, dining room is 300 lux. The third type of light is accent light, it is often for aesthetics purpose such as present art works, texture.

Illuminance (lux)	Surfaces illuminated by
0.0001	Moonless, overcast night sky (starlight) ^[3]
0.002	Moonless clear night sky with airglow ^[3]
0.05–0.36	Full moon on a clear night ^[4]
3.4	Dark limit of civil twilight under a clear sky ^[5]
20–50	Public areas with dark surroundings ^[6]
50	Family living room lights (Australia, 1998) ^[7]
80	Office building hallway/toilet lighting ^{[8][9]}
100	Very dark overcast day ^[3]
320–500	Office lighting ^{[7][10][11][12]}
400	Sunrise or sunset on a clear day.
1000	Overcast day; ^[3] typical TV studio lighting
10,000–25,000	Full daylight (not direct sun) ^[3]
32,000–100,000	Direct sunlight

from wikipedia <https://en.wikipedia.org/wiki/Lux>

For comfort and ease of adaptation, make the ambient illuminance at least 33 percent of the task illuminance.

Indirect and direct light

The natural light has two different ways to light up our surroundings, direct and indirect. Direct light like sunny day light, the light is strong, passionate, leaving clear shadows and borderlines. When the light beam hit on a stone wall, the detail of surface will be well presented and you can see every detail of the material. In contrast, indirect light like the light in cloudy day, every place will be lighted with a same amount of light, everywhere looks the same, potholes on surface will disappear, even the shadows will disappear.

Direct light from the sun and detailed surfaces



<http://onekindesign.com/2011/08/03/luxurious-andalucian-villa-with-impressive-views/>

indirect natural light

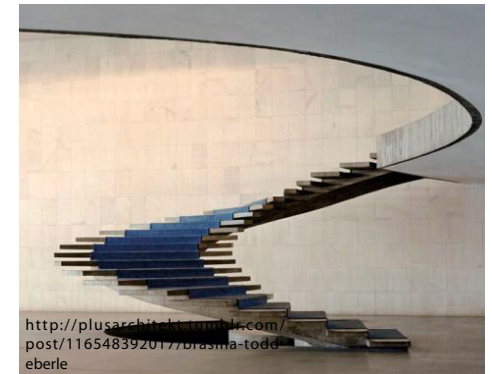

<http://plusarchitect.tumblr.com/post/116548392017/brasma-todd-berle>

Reflect light

When people start to light up the space, direct and indirect light are two basic light for people. Reflectors, diffusers, lens, and prism are tools for people to control the light. The most common way to create reflect light is use reflector or diffuser. Translucent textiles glass are used for shade to mimic indirect light in nature. Reflectors and lens are used to redirect the light to create direct light to specific task.

Louis Poulsen is the most famous company which design and making reflect lamps. PH lamp which is designed by Poul Henningsen is the most famous lamp for reflect lamp. Reflect structure hide light source cleverly to avoid glaring. "Inspired by our urge to

carry the soft luminescence of the Scandinavian summer into the dense darkness of the Scandinavian winter, Louis Poulsen has always sought, not to design lamps, but to shape light (Louis Poulsen website)", lamp is the carrier which carries need and passion from light.

The lamps which are not from architecture light system will be a part of home space. Reflector give a lamp opportunity to be a decoration in space, SERENA from Flos shows very elegant curve and jewellery looking reflector.

Reflection can also be a part of the space, such as UP lamp from Arpel lighting, a wall become a big reflector of the lamp system. Reflected light is good to present portraits and hide the detail of a surface.



SERENA from Flos



UP lamp from Arpel

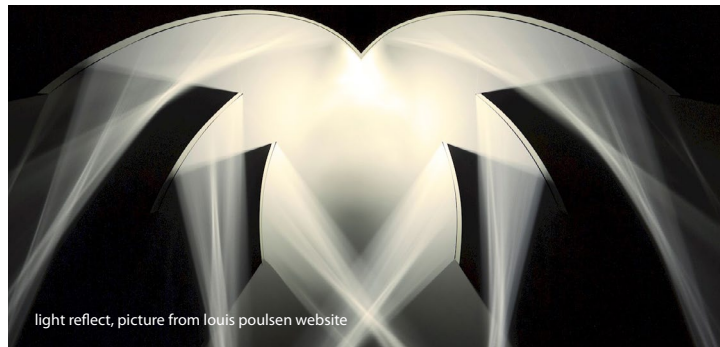

light reflect, picture from louis poulsen website



Ph lamp from louis poulsen Picture from louis poulsen official website

Task light

When people focus on detailed work at night, task light is very necessary. With adjustable structures task light can reach very big areas and directions to support people work. Later with more precise manufacturing and stronger materials, structures can be hidden under the cover, in this situation lamps become clean and less structural looking. Task light not only stays on your desk dimension, it can go in big areas, like open space and factories, in this situation, a high position is needed and ceiling is the best place for this. LP Charisma King from Louis Poulsen can prove proper task light for a big area. combination of these two different lights can give us a proper living and working environment.



work lamp from IKEA



PC lamp from HAY



LP Charisma King

Combination

There is also light which combines two different lights.

In some cases, people change light unconsciously for example when people don't need task light on the table we move it facing to the wall or ceiling to provide better indirect light to light up the surroundings.

Eclisse lamp by Vico Magistretti from Artemide has a movable inner shade which can be rotated to cover the light and reflect to outside shade. The lamp can dim the light by rotating the inner shade and create different light. While at incandescent light bulb age, the temperature of the cover will increase incredibly high, and user cannot touch it.



Eclisse lamp by Vico Magistretti

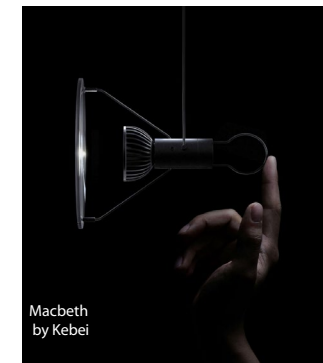

Macbeth by Kebei

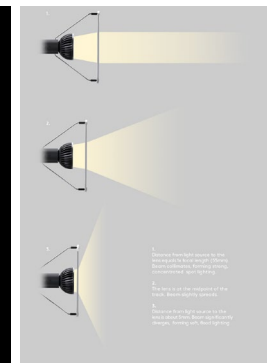

Macbeth designed by Kebei team
Macbeth is design to switch into different light, with lens.

Light control

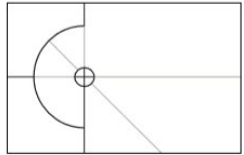

Light can be controlled in many ways. The most common way is to use reflectors and lens.

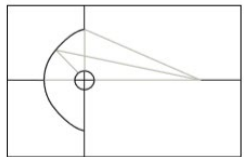

Both reflectors and lens can change light. The same light source can be present in task light or ambient light with different reflectors or lens.

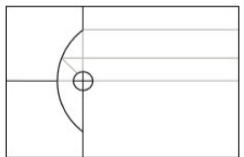

Ray tracing from a point light source when reflecting on circle, ellipse, parabola and hyperbola (from top to bottom).

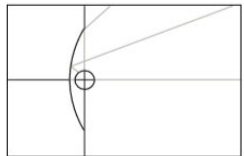

(P92 Handbook of Lighting Design By Edition Rüdiger and Ganslandt Harald Hofmann)

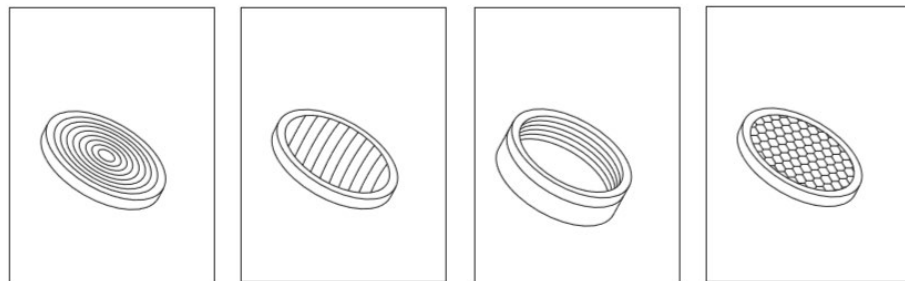

(P92 Handbook of Lighting Design By Edition Rüdiger and Ganslandt Harald Hofmann)

Spherical reflectors

In the case of spherical reflectors the light emitted by a lamp located at the focal point of the sphere is reflected to this focal point.

Parabolic reflectors The most widely used reflectors are parabolic reflectors. They allow light to be controlled in a variety of ways – narrow beam, wide-beam or asymmetrical distribution, and provide for specific glare limitation characteristics.

Involute reflectors Here the light that is emitted by the lamp is not reflected back to the light source, as is the case with spherical reflectors, but reflected past the lamp. Involute reflectors are mainly used with discharge lamps to avoid the lamps over-heating due to the retro-reflected light, which would result in a decrease in performance.

Elliptical reflectors In the case of elliptical reflectors the light radiated by a lamp located at the first focal point of the ellipse is reflected to the second focal point. The second focal point of the ellipse can be used as an imaginary, secondary light source. (P85 Handbook of Lighting Design By Edition Rüdiger and Ganslandt Harald Hofmann)

Wider and softer light distribution can be achieved using flood lenses, whereas sculptural reliefs produce an elliptical light cone. Additional glare shields or honeycomb anti-dazzle screens can be used to improve glare limitation. In the case of increased risk of mechanical damage, above all in sports facilities and in areas prone to vandalism, additional protective shields can be fitted (P92 Handbook of Lighting Design By Edition Rüdiger and Ganslandt Harald Hofmann)

How does lamps access spaces?

A lamp is a physical product and it always relate with the space around it. The most common way to access a furnished space is a free standing structure such as ORCHID by Rainer Mustsc. Pendant light is very common for the ambient light, ceiling is free for big lamps. Higher place offers a better position for lighting up everything beneath it.

Clamp is a solution for reducing table spaces, it is also stable. Fixed lamps such as wall lamps or ceiling lamps are often for beginning of the plan of a unfurnished space.



Pablo Designs Link Clamp Mount Table Lamp



ORCHID from rainer mustsc

Types of floor lamps

Freestanding structure gives floor lamp free access to spaces. It is the easiest lamp to enter the space without refurnish or destroy surroundings. It is also a good second light choice at home.

There are 10 basic floor lamp types, swing arm lamp, torch lamp, tower lamp, table lamp, multiway/tree lamp, club lamp, downbridge lamp, arcing floor lamp, chandelier, tripod lamp.

Tree lamp is common to use in a small space like student dorm, as it can provide different light and direction at same time, Ikea lamp can provide reading light for sofa, light up corner and also for surroundings. arcing lamp is good for small space in some cases, the long arm allows the use put the lamp into the corner, while in some cases the long arm will block the walking path at home. Torchiere is a good second light at home, it pointed toward the ceiling and provide reflect light for the whole space.

Most of the floor lamp is task light, especially torchiere, tree lamp downbridge lamp. while lamp like tower lamp, club lamp and chandelier can be in textile, glass or crystal.

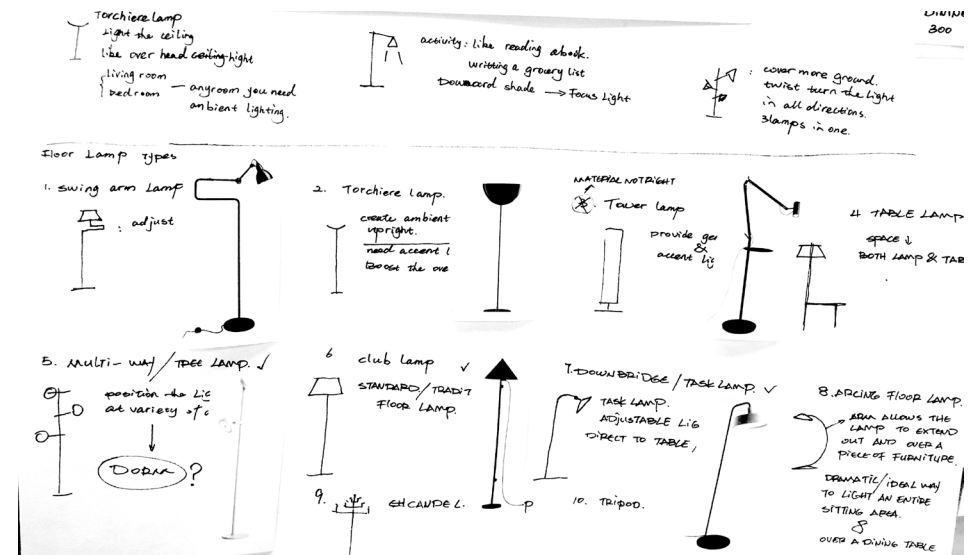

Design intention

Light which can support people's need for sufficient light in compact living, at the same time make a design that avoid complicated structures that get in the way in the crowded surroundings of compact spaces.

Criteria



PH Louvre from Louis Poulsen



copenhagen stool from HAY



Der Kleine Lehner from moormann

Eriz from swissdesignawards

aesthetics (personal)

Design is "a full expression of what a thing is or does"-----george nelson

In furniture design, as in architecture, the intelligent solution of practical problems can combine with an expressive development of form to produce a useful and visually meaningful result.

"furniture modern + postmodern + design + technology'

" If we take a spoon to represent form, I would say the spoon is a container and an arm, both of which are inseparable to spoon. If I were to design a spoon, I would make it out of silver or wood, shallow or deep. That's where the design comes in: it's measuring it, it's putting it into being. But what most characterises spoon from other instrument is form what it is."-Louis Kahn

Mandatory

Modular

Products should be easy to be developed for enriching product line.

Access to space

The design should offer easier access to compact space, such as minimize occupied space.

structure,physical relationship with surroundings

Part of the space

Products should look like a part of the space instead of enrich complicated surroundings.

Aesthetics relationship with surroundings

Market segment

Price should be controlled in middle or lower price.

Recommended

Customize

Each compact space has its own quest, customization is the good strategy for users to design their own living space. Simplicity and flexibility is good for manufacture to develop new product which based on exist product line, to rich their product line.

Organized

product which is good for compact living, should be well organized itself, it should also be easy to get along with and utilize surroundings. Geometric shape is simple way to relate to environment.

Multifunctional

Multifuntion can give more possibilities for one product and save spaces.

Optional

Why not?

Colours

More colour options for various room conditions.



Camera by Jony Ive and Marc Newson for Leica



Link from pablo design studio



designed by Miguel Milá for Santa & Cole



<https://lemanooosh.com/publication/62635/>



Peek lamp from Menu



ZEN Tube. Design Rubén Saldaña



REO by Delta Light



KUULA for THONET & OLIGO

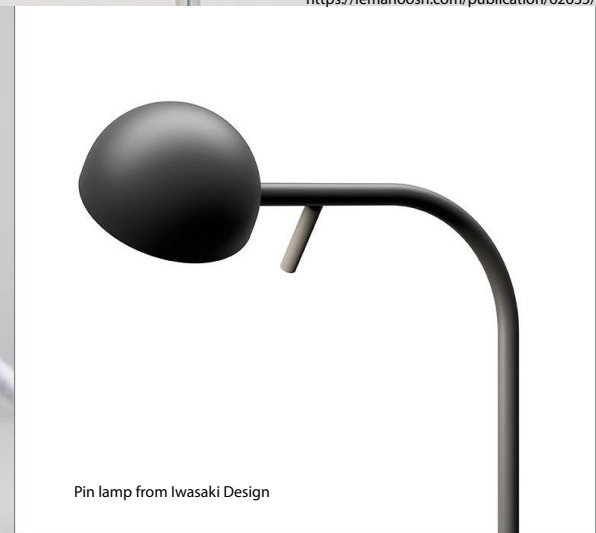

Pin lamp from Iwasaki Design



Kizuku from Wästberg

Concept

The concept is a lamp which can provide both direct and indirect light, and with different accessories, it can adapt to different basic living situations.

Idea development
&
Experiment
sketches, 3D models,
mockups,

Very early sketches

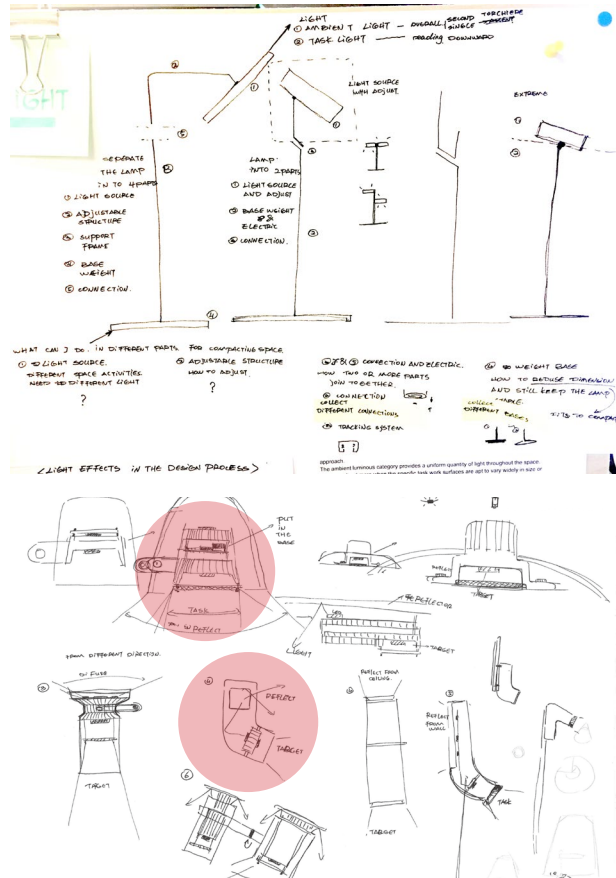

I sketched this basic system as the first sketch, light source would be a main part of the lamp, with easy connection and accessories this main part can approach to different places.

I did fast sketches to realize my concept which a lamp can provide both direct light and indirect light. With drawings I did paper models later.

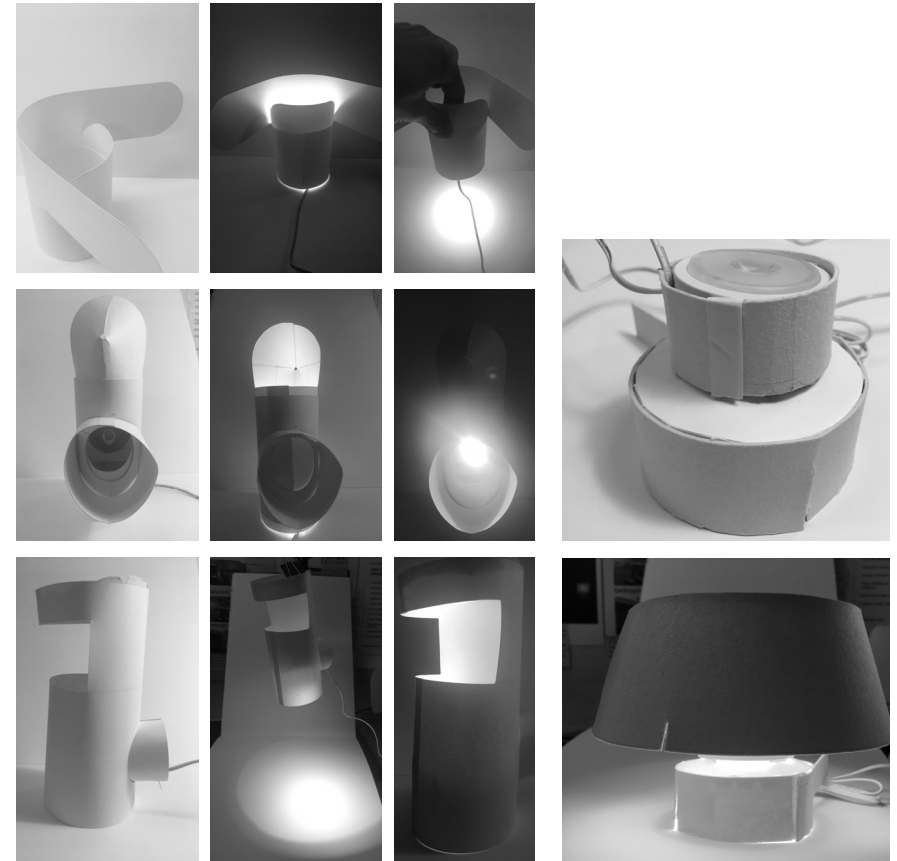

I started with paper models to test a lamp with both direct and indirect light. After several experiments, I organized experiment into two basic ideas. First, a lamp with a rotating movement can switch task light into reflect light. Second, a lamp with two light resource which can provide both light at same time. I printed 3D model and tested.

Fast 3D printed model



No: Rotation

From paper model which the light can be changed with single rotation, I made this model to test light. This idea can provide good task light, while without big reflect area, reflected light is not good.

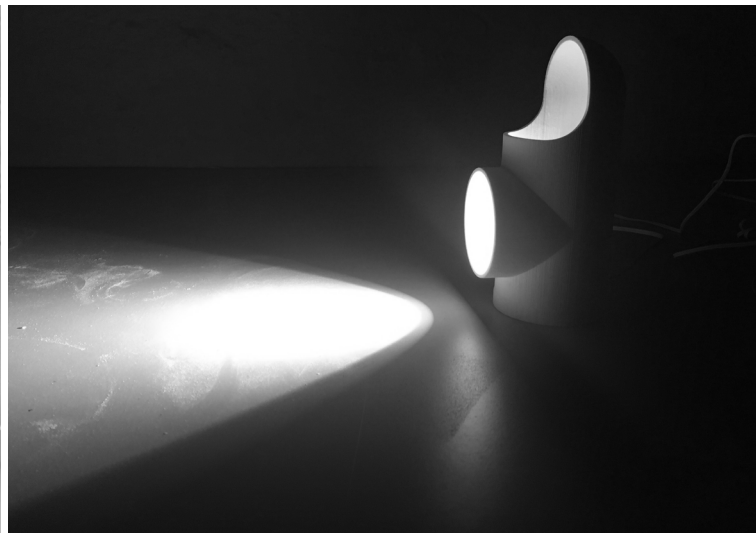

Shape test

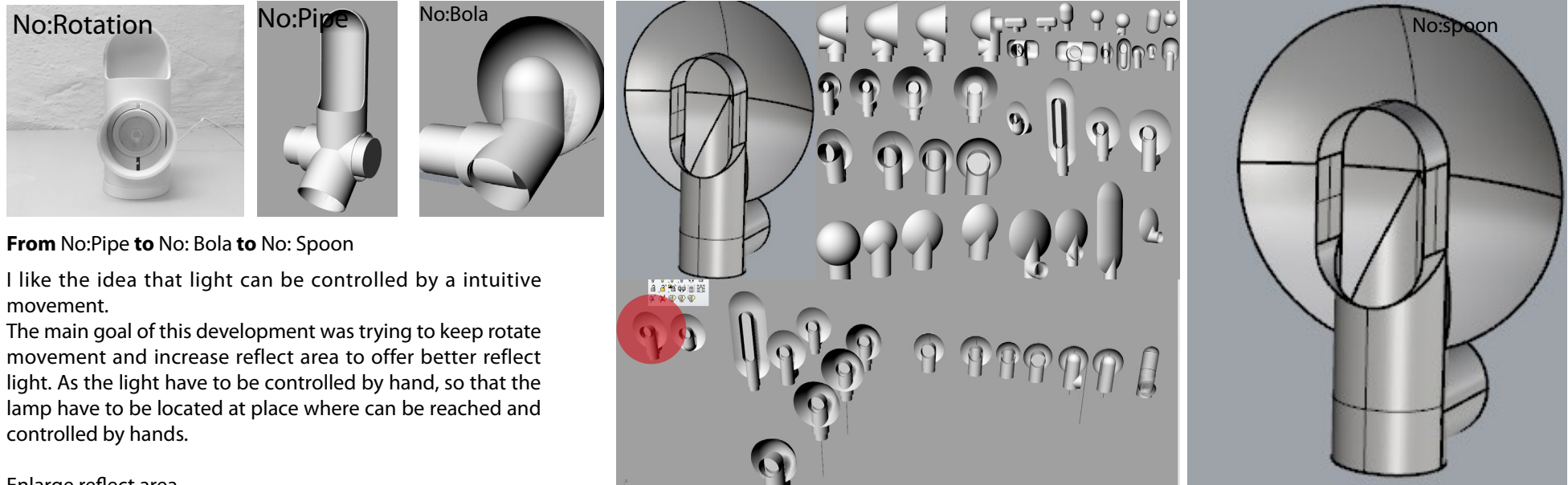

From No:Pipe to No: Bola to No: Spoon

I like the idea that light can be controlled by a intuitive movement.

The main goal of this development was trying to keep rotate movement and increase reflect area to offer better reflect light. As the light have to be controlled by hand, so that the lamp have to be located at place where can be reached and controlled by hands.

Enlarge reflect area.

Several shapes were tried. It was started with simple idea of enlarging reflect surface. I made No:Pipe. I extended opening on the top, and task light is tilt with 45degrees to let more light hit on reflect surface when the light change to reflect light. But the reflect surface is still not big enough to provide good light.

Based on No: Pipe, I enlarged reflect area in 3 dimensionsNo:BOLA, theoretically this shape can provide better reflect light. While the shape need to be improved, as it is not simple. In the end I made a sphere reflector shade No:Spoon. As this shape can light up bigger area and softer light than task light. It is also flat and simple.



Light test



Later a light test model was built, at this stage it has the characteristic with circle and square in side. It is real size model. The diameter of reflector is 180mm and I used two task led light (each one can produce 240Lum light) to mimic the light source which can equals 40wat incandescent light bulb which is often used for floor lamp.

Light test, from the pictures you can see difference between task light and reflect light. 1, Lighted area is different. 2, Direct light can show more detail of the wall surface than reflected light. Reflect light can hide details which can smooth the surface.

As the lamp is half open design, when user rotate the light, at specific angle, light source can be seen and it could cause glare. This position is also not good for neither direct or reflect light, so that I decide to develop position as a switch off position. This would be test later with prototype.

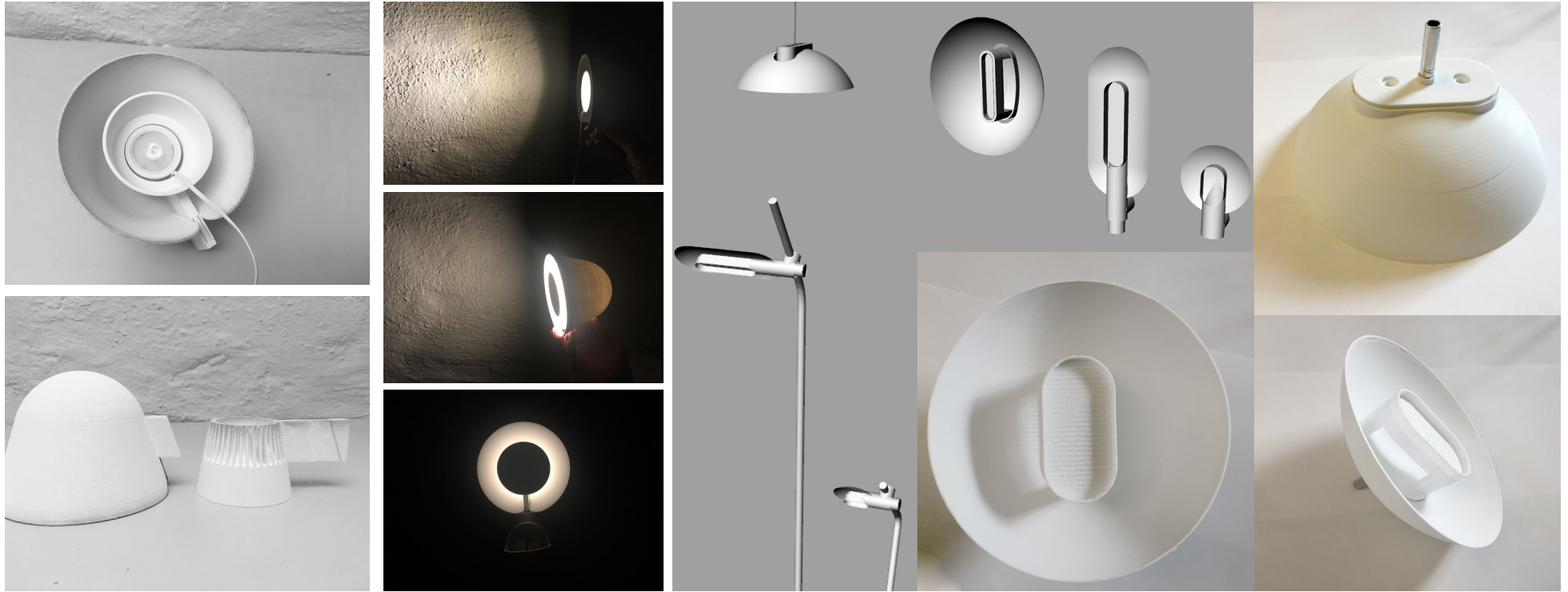

An abandoned idea

This is a parallel work with rotation idea. It is the development of paper model which can provide both light at same time with two light LED chips. This idea went really far with rotation idea, as I cannot make a decision. Before second midterm I made a series lamp which combined both rotate idea and this idea. But in the end I abandoned this idea, as I prefer rotate movement more.



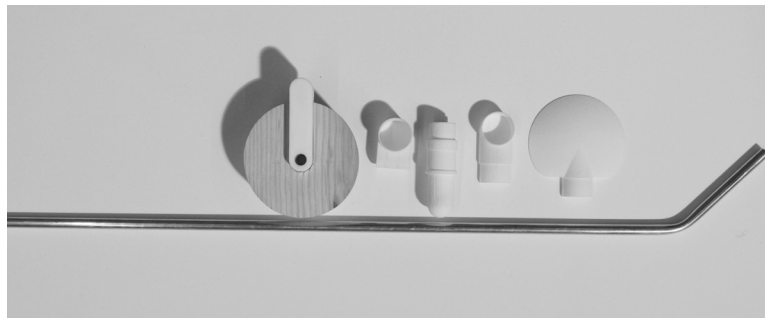
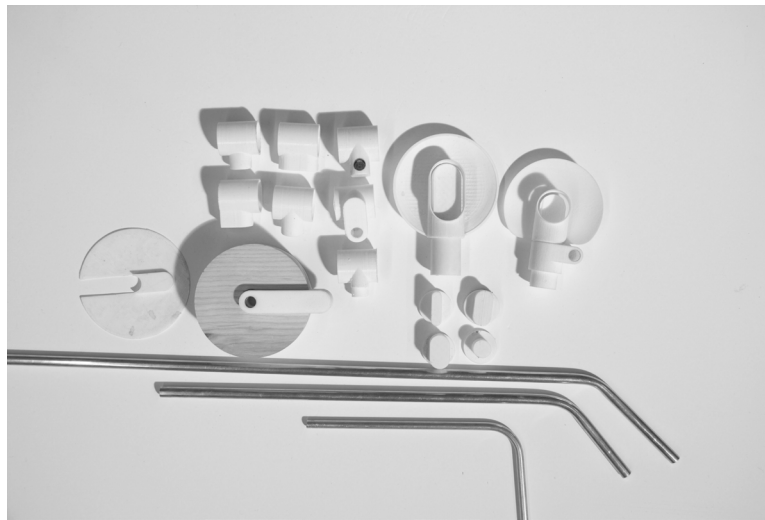
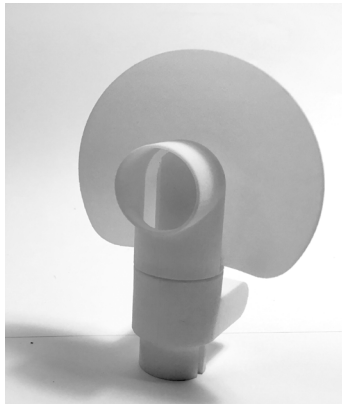

Overall shape is changed to a more compact shape. Now the lamp is divided into two parts, shade and rotate parts.



In the end I decided to use a shape which contains a big and a small cylinder for the connection. Circle implies rotation. Rotation always happens with circle or cylinder. Furthermore, the small cylinder merged into bigger one without create any extra surface or shape.

Shade controller

First modification is to add a shade controller, as there is no place for hand to control the shade. Because two shades are tightened by the red part(from the picture), so the extension of shade is the perfect area for controlling. The shade controller can lock the shade.

Shape of the shade controller

The space started with a ring which is cutted on oneside, as the ring itself doesn't show directions. While the direction of the shade need to be showed, so that I made a cut on the ring and the edge of the cutting edge can show the direction. Later I soften the edges and reduce the cutting edge of the ring to make it home feeling.

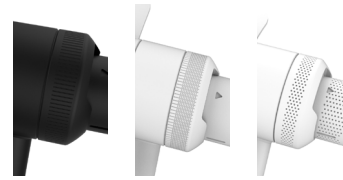
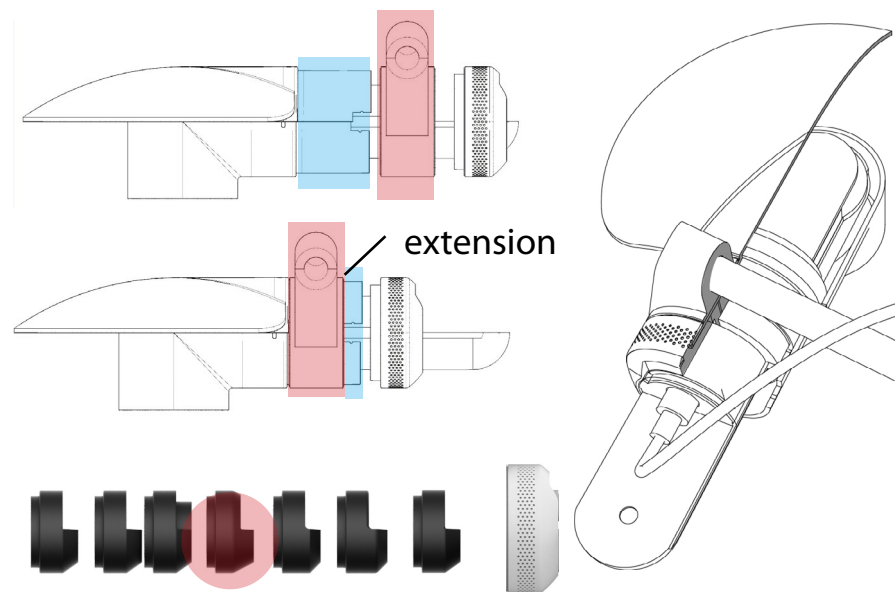

Grip:

Several texture for griping were tried, during the test, stripe texture works well as functional part, while it looks too different with overall shape. Later I tried with dot shaped grip, it looks better and fits to overall shape.



Rotate switch

It was started with ideas that if I can smooth the shape of shade controller, as from first printed 3d small scaled mode, the shape is rough and hard. The change is to have a chamfer on sharp edges. With black color it looks technical and industrial. Later I tried to make it even more round, so big rounded corner is added on the lamp, with white color it looks more friendly and soft. Both changes works.

In the end, I wish I can not only make it works well, but also make it more intuitive. As the rotate controller is the extension from heat sink, I wish the rotate controller can implies the rotation movement of heat sink. Furthermore, the heatsink part is shaped half cylinder, so that the rotate part should follow the shape of half cylinder. With flat surface, it is easier for user to grip it.



Rotate controller

When the cover rotate, the light and light controller should follow the rotation while the light controller shouldn't affect cover control.

friction: shade direction control > light mode control

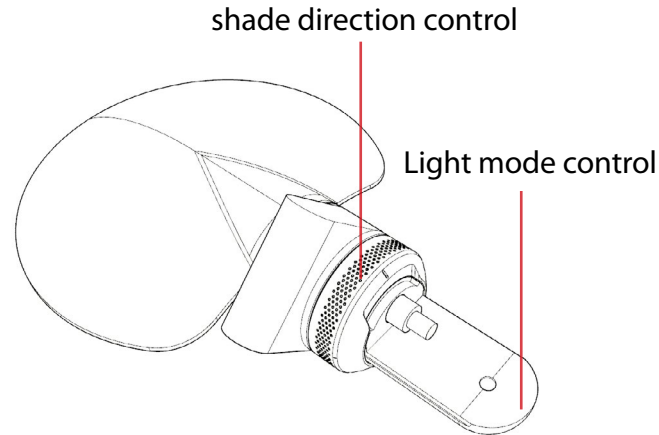

○ reflect light

△ task light

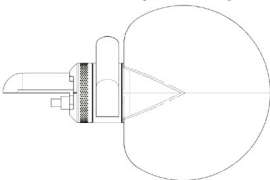
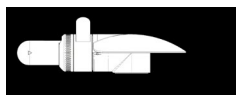
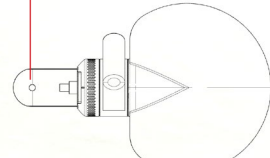
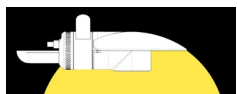
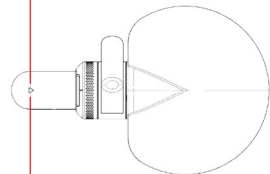
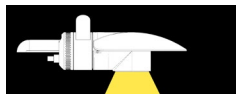

light on/off area:
when the sign is rotated to this area,
the light could be lighted up.

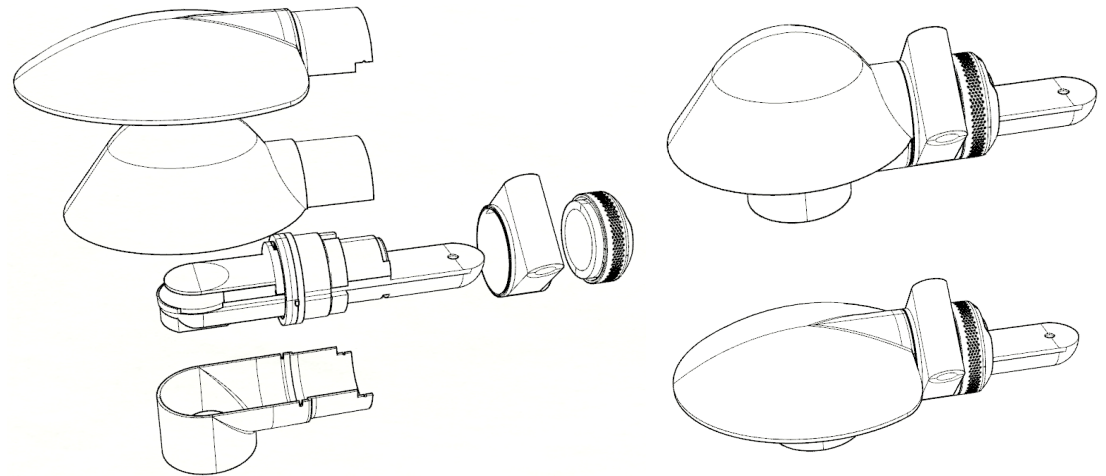

Light source is designed to have several modular parts. There is no cables or screws on the shade. All the parts are attached to the core which contains electric and LED. Modular parts are fixed by the part which connect to frame, and shade controller. Shade can be changed independently, in the future different shade can be developed to adapt to different need. At this moment I just tried another shade which is parabola shape and it can provide more focused reflect light than sphere shaped shade.

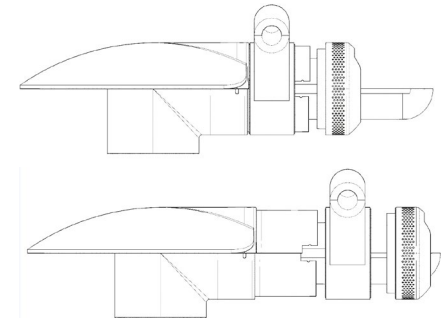

Connection with different part



This idea was to hide cable inside frame, while as the cable goes in the lamp from side, it cause many troubles. I wish I can offer believable solutions to the problem. A slip ring was tested. It works well in this context, While cost will be increasing by more complicated structure and parts. So this idea was abandoned later. But a rotating switch was developed base on this slip ring, which is used on the prototype, to provide both switch between task and reflect light, and main switch on/off. In the end , the cable connect with the lamp at the end of the lamp.

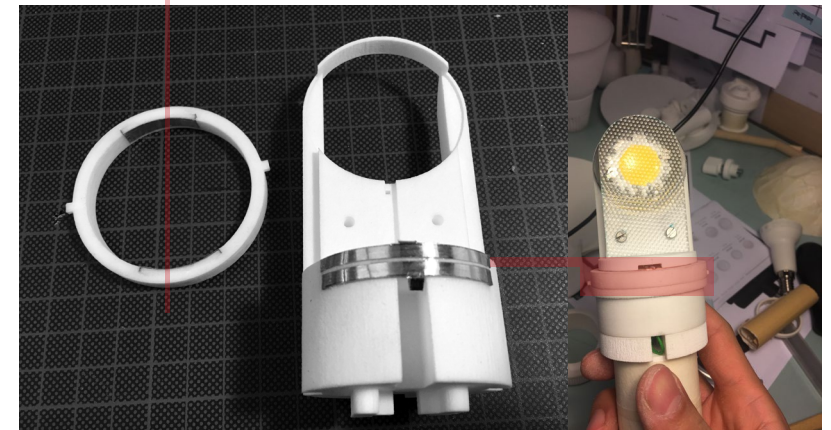
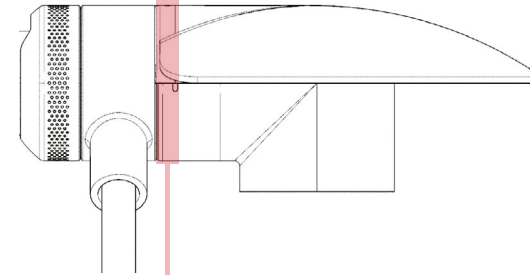
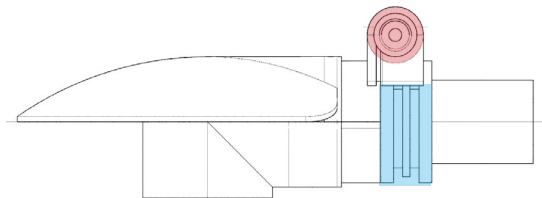

A rotate switch, this mechanism provide solution of switching between task and reflect light and switch on/off with single rotate movement. Electric circuit can be connected when the metal sheet on the ring touch both metal parts. In the future with co-operate with engineer, the mechanism can be improved for mess product. At this moment this is just a idea testing.

Access to space



This part is structure design, it started with freestanding structure. As free-standing structure is easy to go into a space without fix structure. It is very common solution to add an extra light into a place with already furnished surroundings or a space without good lighting conditions, and it is a very good second light source in the environment.

But one thing cannot be ignored when floor lamp approach into small spaces--the base. Enlarge base can provide stable standing, while enlarge in compact space is not the first choice. In many cases floor lamps are situated in the corner or behind sofa, so the base can be hidden.

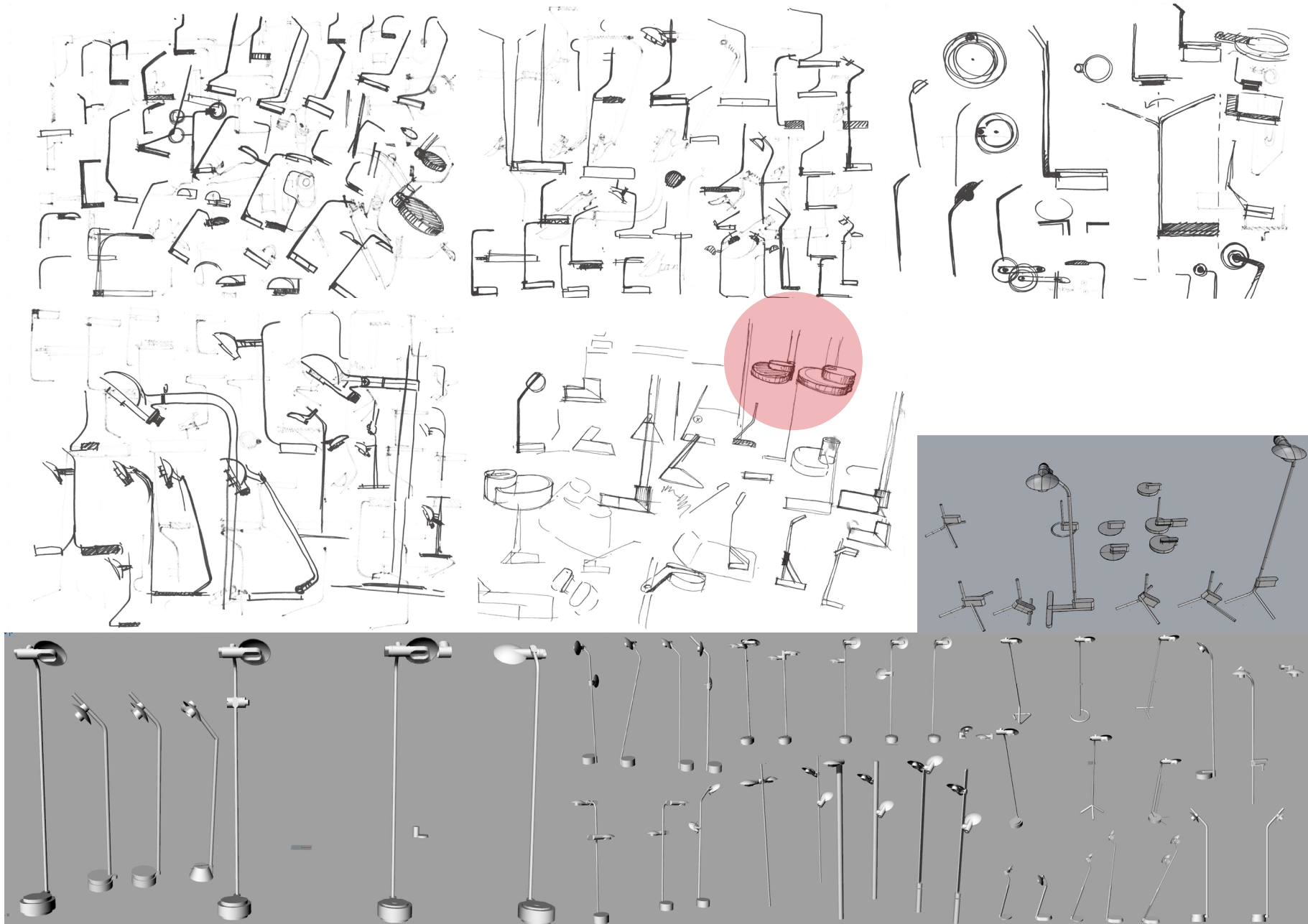

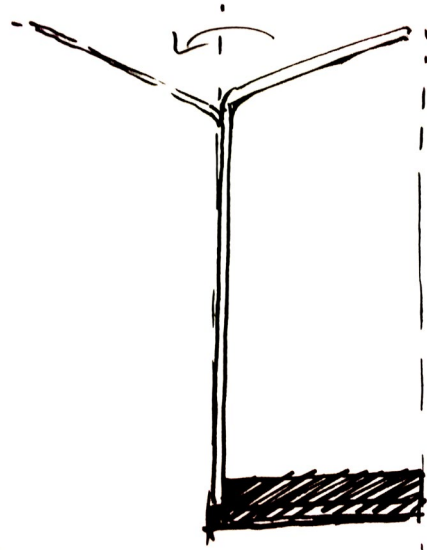

This idea is to extend reaching area of lamp. As the reach area is not increased a lot but add an off center rotation which could cause tilt. So that I abandond this base, but keep bended shape of the frame.





This basic structure bring a simple frame and a small base to space, there is also a place where the adapter can be hidden inside.



New clamp system

Any space in compact living is precious, so that could I offer a better solution instead of only a freestanding structure? Furthermore, accessory is very important from research. Accessories give lamp more opportunities and possibilities.

Later I have an idea of clamp, as clamp can provide very stable frame, it also occupy little space. As in compact living place, everything is closer than normal living place. Fully use of surroundings are the spirit for compact living.

Completely utilize different parts of products.

There will be three basic accessories for this lamp at the moment, a clamp, a simple frame which are bended pipes with two different length, base. With these three basic accessories, the lamp can fits to many situations. It can be used as a freestanding floor lamp, freestanding table lamp, it also can be used as a floor lamp with tables which can be clamped on.

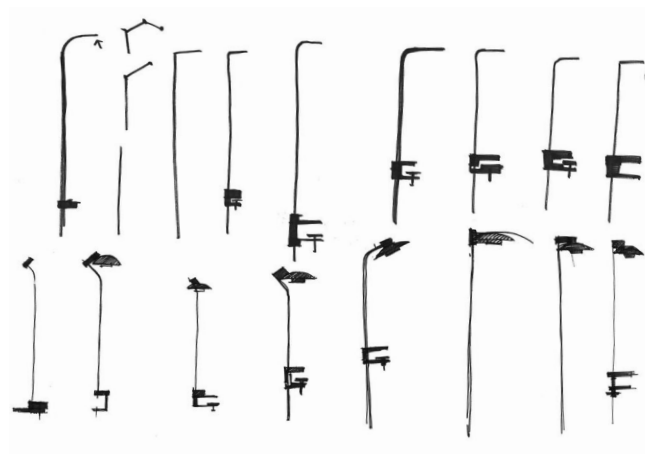
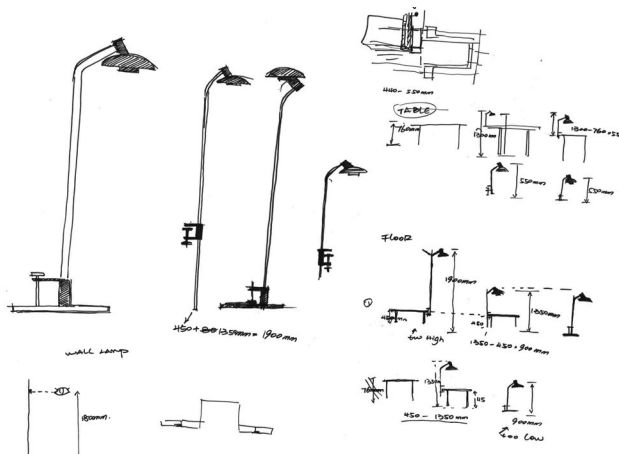
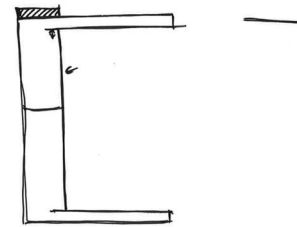
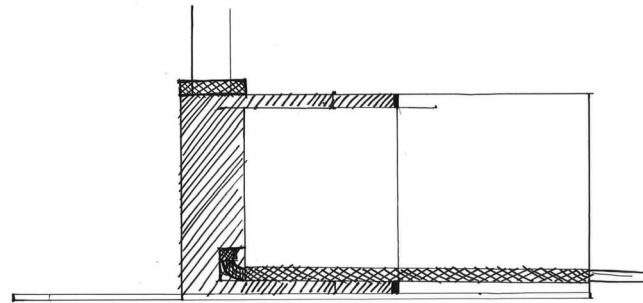

Clamp and frame sketches

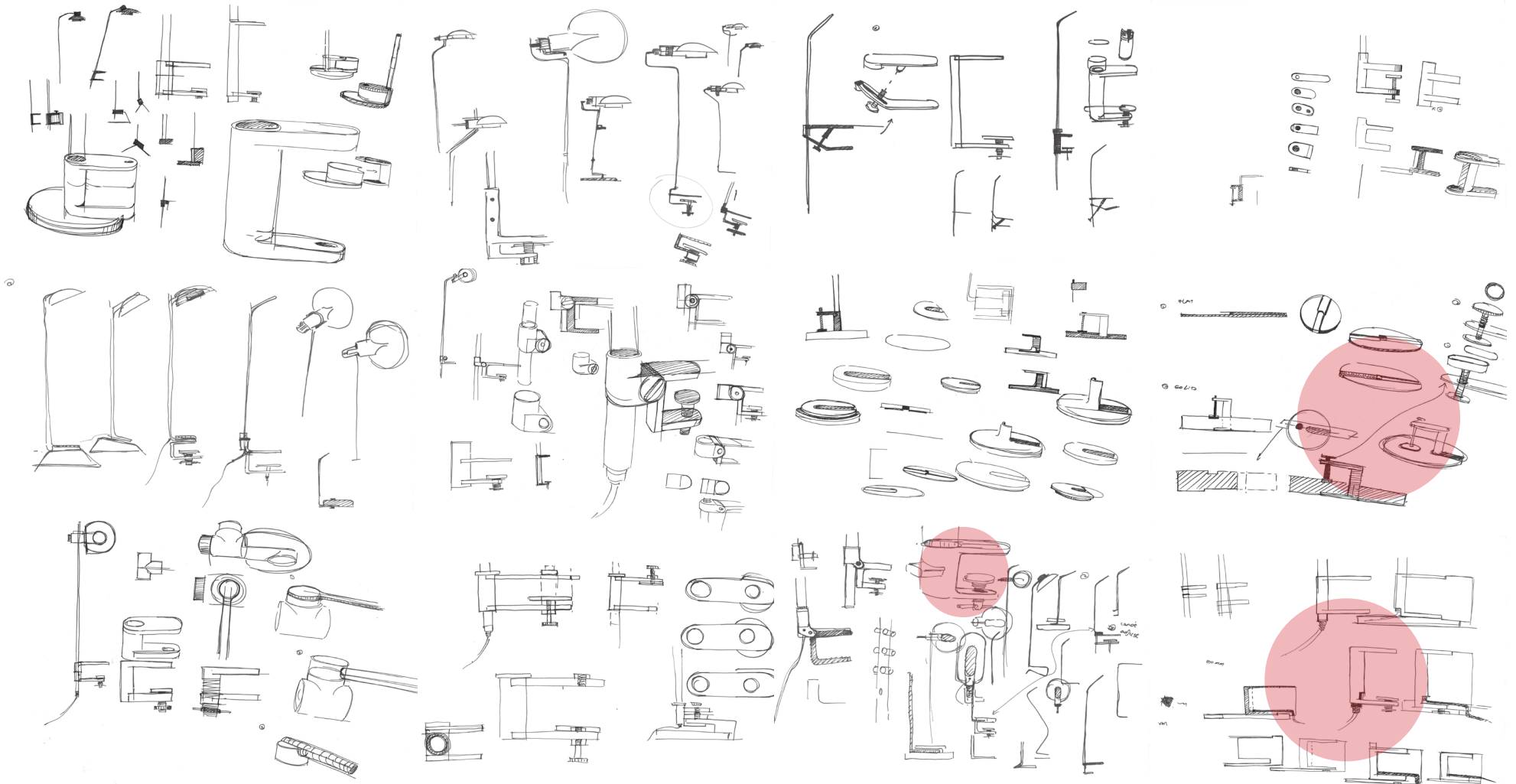

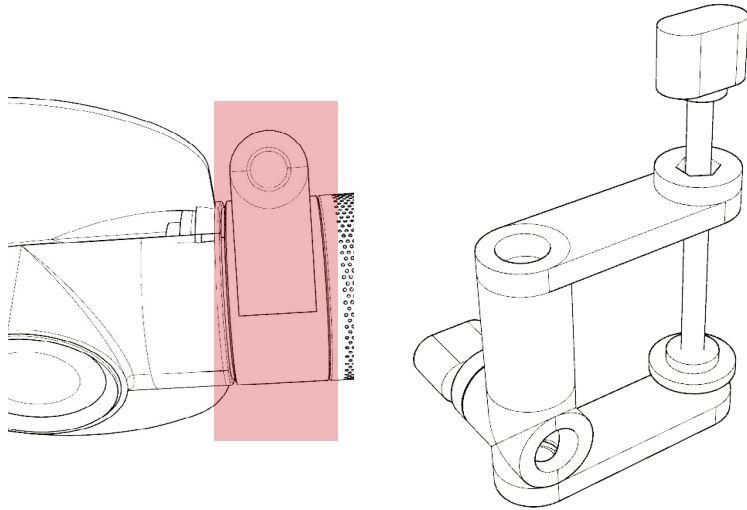

The shape of clamp follow the shape of connect part. The shape is square with circle in the end. The clamp also follow the rules which circle implies rotating movements.

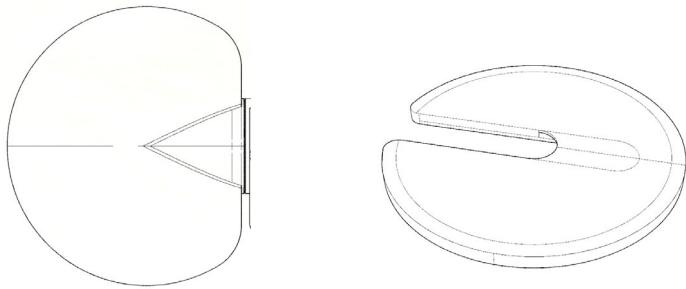

Base is a simple part. Connection between base and lamp head is built on the overall shape. The base is designed to be similar with lamp. A big round corner is added to soften the sharp corner.

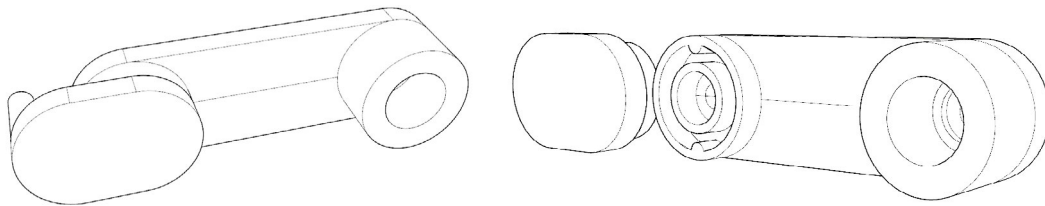

Share the same characteristic with clamp ----square with circle in the end. The fixing screw can be hidden in the frame

Small scaled models



Small scaled model are made for shape testing, the proportion is 0.4:1

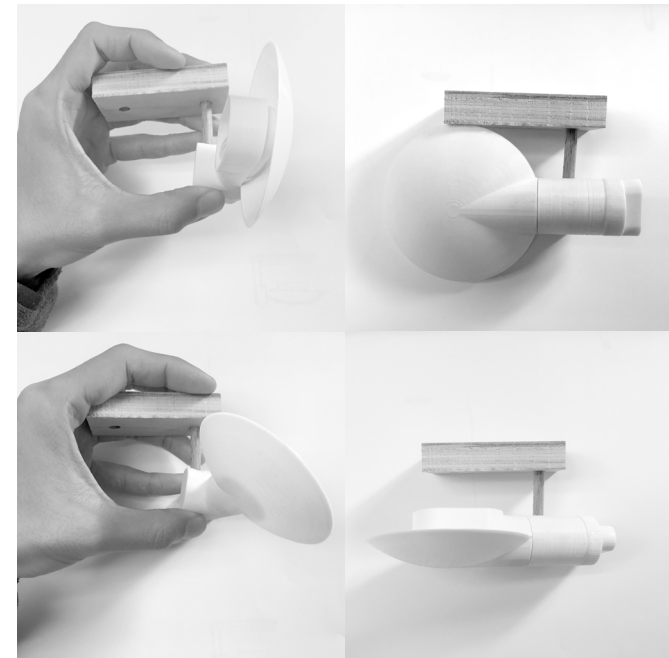

idea of lamps systems and wall mounted accessories

Dimension



Dimension discussion happened through all the design process. Freestanding floor lamp dimension is discussed first. With study of exist lamps, I gain the basic height knowledge of freestanding lamps, with furthure study of ergonomics, I know the eye height level, sitting height. Then is the reaching area study, to discover which hight is the best hight for adjustments. as surroundings are very important for compact living, so that I also studied basic height of common furnitures at home.

Figure 3.3.3.1.1 of 10 Anthropometric (Dimensional) Data for American Female
Body Size of the 40-Year-Old Japanese Female for Year 2000 in One-Gravity Conditions

Microgravity value	No.	Dimension	5th percentile	50th percentile	95th percentile
2.1	716	Sitting height	79.3 (28.8)	84.4 (30.4)	91.2 (33.5)
2.1	330	Eye height, sitting	68.1 (25.6)	73.6 (26.1)	79.9 (21.4)
4	529	Knee height, sitting	41.6 (15.4)	45.1 (17.5)	49.5 (19.5)
676	676	Popliteal height	34.7 (13.0)	38.3 (15.1)	41.9 (16.0)
751	751	Shoulder-elbow length	27.2 (10.7)	29.8 (11.7)	32.4 (12.8)
194	194	Buttock-knee length	48.9 (18.2)	53.3 (21.5)	57.8 (22.7)
405	405	Hand length	18.6 (6.2)	17.2 (6.6)	18.7 (7.3)
411	411	Hand breadth	8.9 (2.7)	7.6 (3.1)	8.6 (3.4)
416	416	Hand circumference	18.5 (5.5)	17.5 (7.0)	19.3 (7.8)

Figure 3.3.3.1.1 of 10 Anthropometric (Dimensional) Data for American Male
Body Size of the 40-Year-Old American Male for Year 2000 in One-Gravity Conditions

Microgravity value	No.	Dimension	5th percentile	50th percentile	95th percentile
2.1	716	Sitting height	88.4 (31.0)	94.2 (37.1)	99.6 (38.2)
2.1	330	Eye height, sitting	75.1 (30.3)	81.9 (32.2)	86.9 (34.2)
4	529	Knee height, sitting	52.4 (20.7)	56.7 (22.3)	60.9 (24.0)
676	676	Popliteal height	40.4 (16.0)	44.4 (17.1)	48.1 (18.0)
751	751	Shoulder-elbow length	33.7 (13.3)	36.5 (14.4)	39.4 (15.5)
194	194	Buttock-knee length	56.8 (22.4)	61.3 (24.1)	65.8 (25.5)
405	405	Hand length	17.8 (7.0)	19.3 (7.6)	20.8 (8.1)
411	411	Hand breadth	8.2 (3.2)	8.9 (3.5)	9.6 (3.9)
416	416	Hand circumference	20.9 (6.0)	21.8 (6.4)	23.4 (8.2)

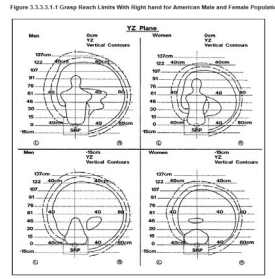

<https://msis.jsc.nasa.gov/sections/section03.htm>
 Female: $84.8 + 38.3 = 123.1\text{cm}$ reach: 161.1cm
 male: $94.2 + 44.4 = 136.6\text{cm}$ reach: 179cm

difference
 America Male: 175.7 F: 162.9
 China Male 167.1 F: 155.8
 Document from Wikipedia

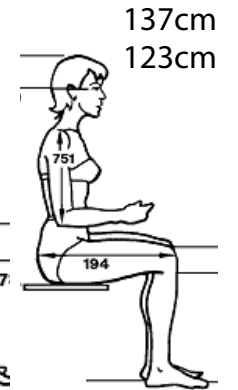
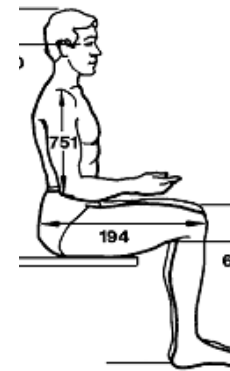
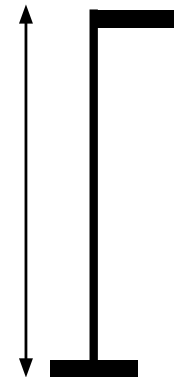
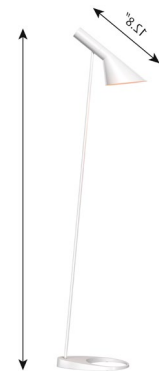
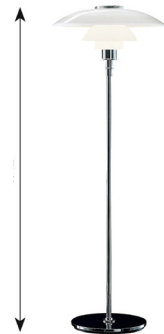
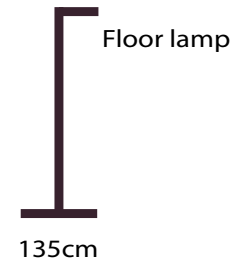
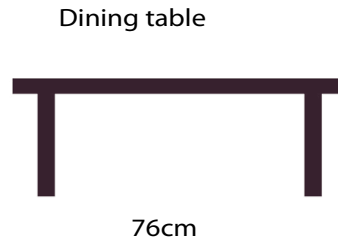

different hight of floor lamps

Height test



Normal sitting height is 137cm for 50th percentile for man, and 123cm for woman. Height of floor lamp on the market is from 120cm to 135cm, around sitting eye height. Later I made a adjustable box for testing the height for my lamp. The range is from 125cm to 150cm. The range is in people's reaching area. while during the test with users, 150cm -140 is in the reaching range but people have to stretch uncomfortable to get it. I wish people can stay under the reflected light furthermore, normally floor lamp are put behind people close to the wall, so that the lamp could slightly above people's head. If the lamp is just at eye level, then it could cause glare. So that I choose 135cm for the lamp which is can be controlled well and also avoid glare.

Interview 1:
 120-130 Comfortable for adjusting height
 140cm stretch too much
 It is good to have dimmer in the middle of the pole.
 Heigher can ligh up more spaces.

interview 2:
 140cm stretch too much
 130cm is comfortable height for control, while the lamp around eye level, the reflect light will blind people. If the light is heigher then it would be fine.

Interview3:
 130cm comfortable for controlling height,
 140cm good height for light. (I like the light a bit heigher)

Interview4;
 140cm stretch too much
 135cm is a good place

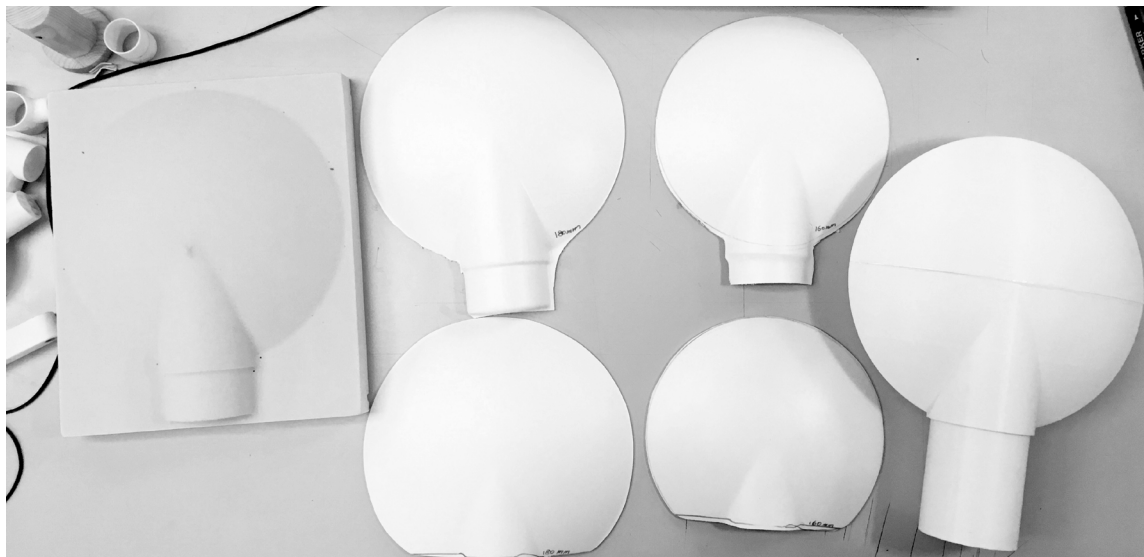

dimension of the shade

The diameter of the shade from 12cm to 20 cm, as the shade here is for reflect light only, the bigger the better of the light, so that I choose 18cm for my lamp, with the cutting shape, the shade looks smaller, and the compact shape is good for compact living.

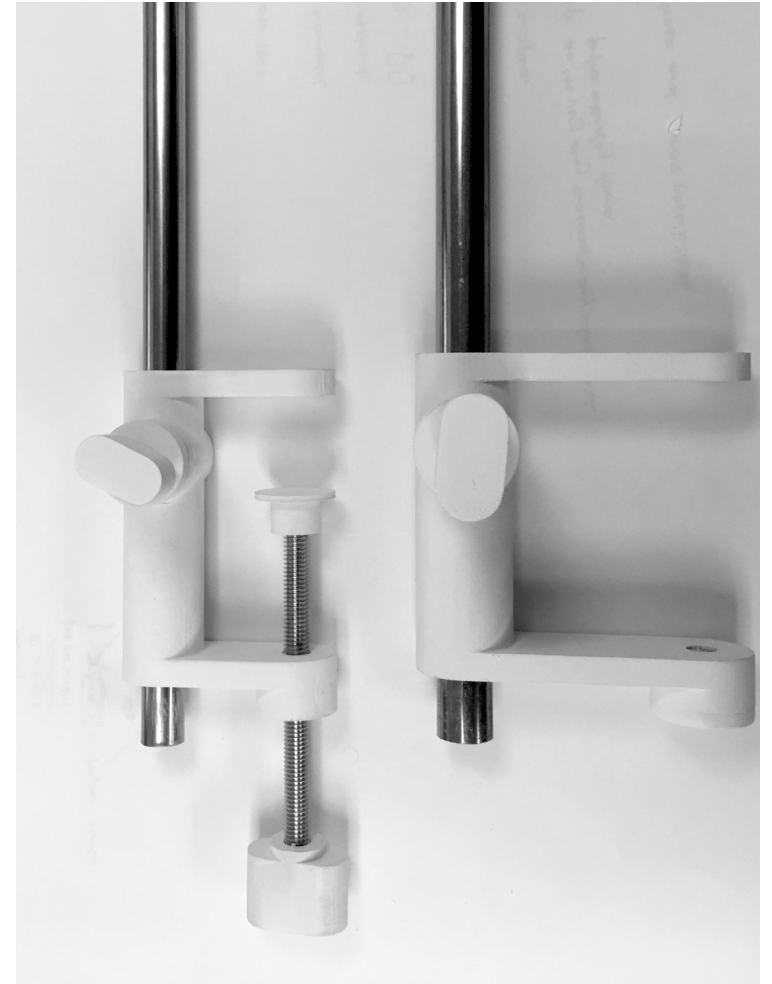

I tried 3 dimension of steel pipe. The pipe reduced from 20mm to 16 and finally to 13mm, as 20mm and 16mm is too bulky for the lamp. Dimension of the clamp also reduced a lot, small size can fit to compact living better.

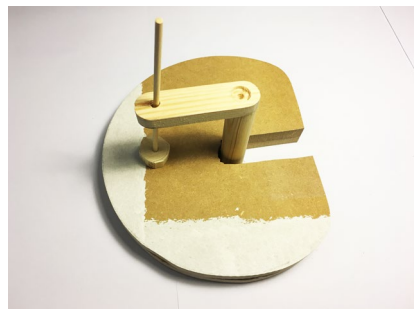
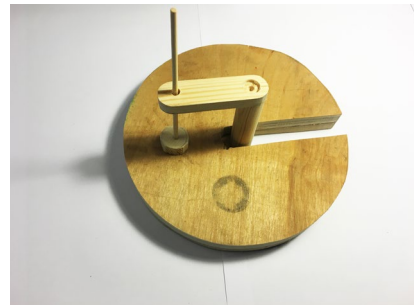
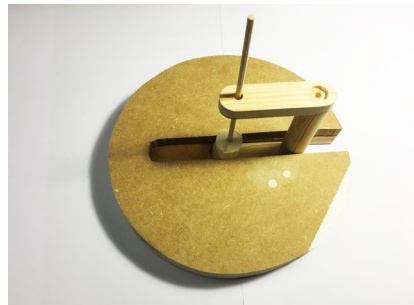
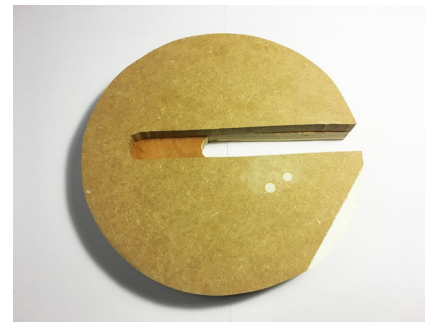
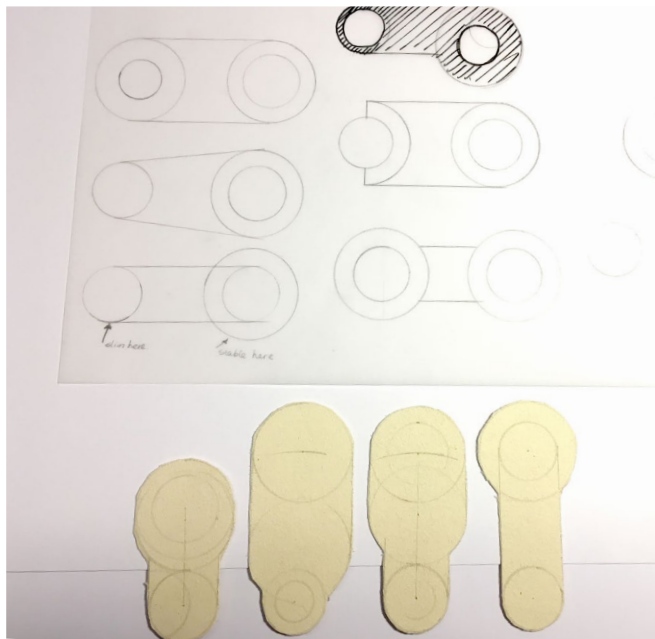

The size of the base is 200mm diameter, I tried 300 diameter as the floor lamp version. The base is too big, too dominant, so that in the end the dimension of the base is 200mm*20mm, if it made in steel it can offer more than 5kg weight, which is enough for the floor lamp.

Floor lamp

With clamp and base, the lamp can access to the empty space.

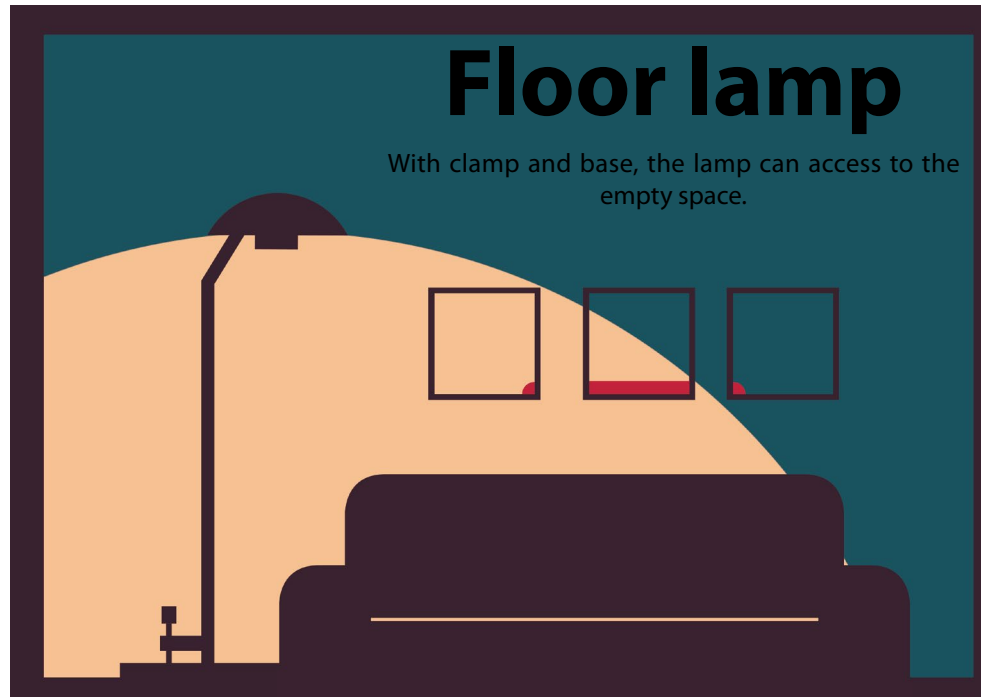

Clamp lamp

With clamp, the lamp can work in livingroom or dining room.

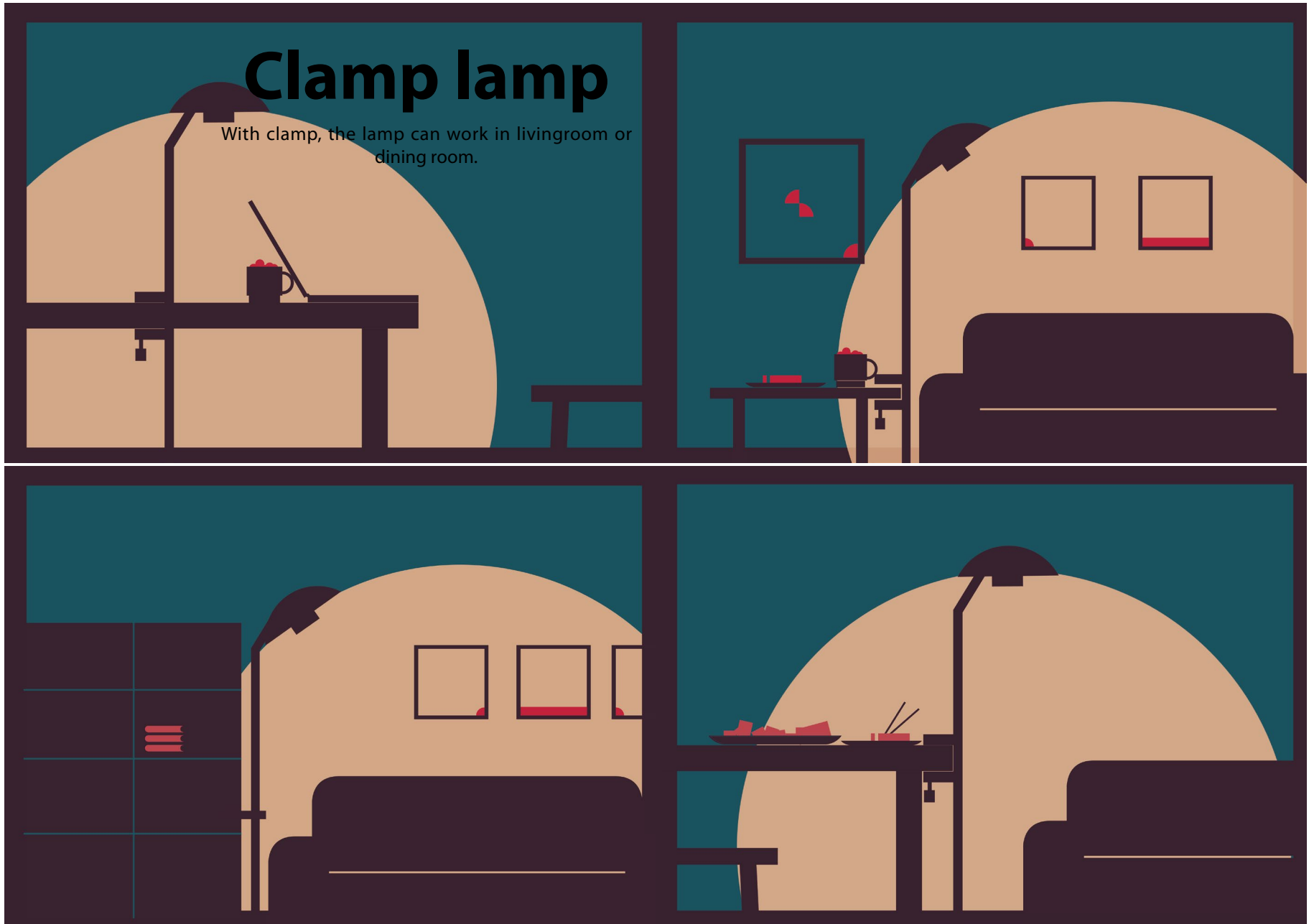

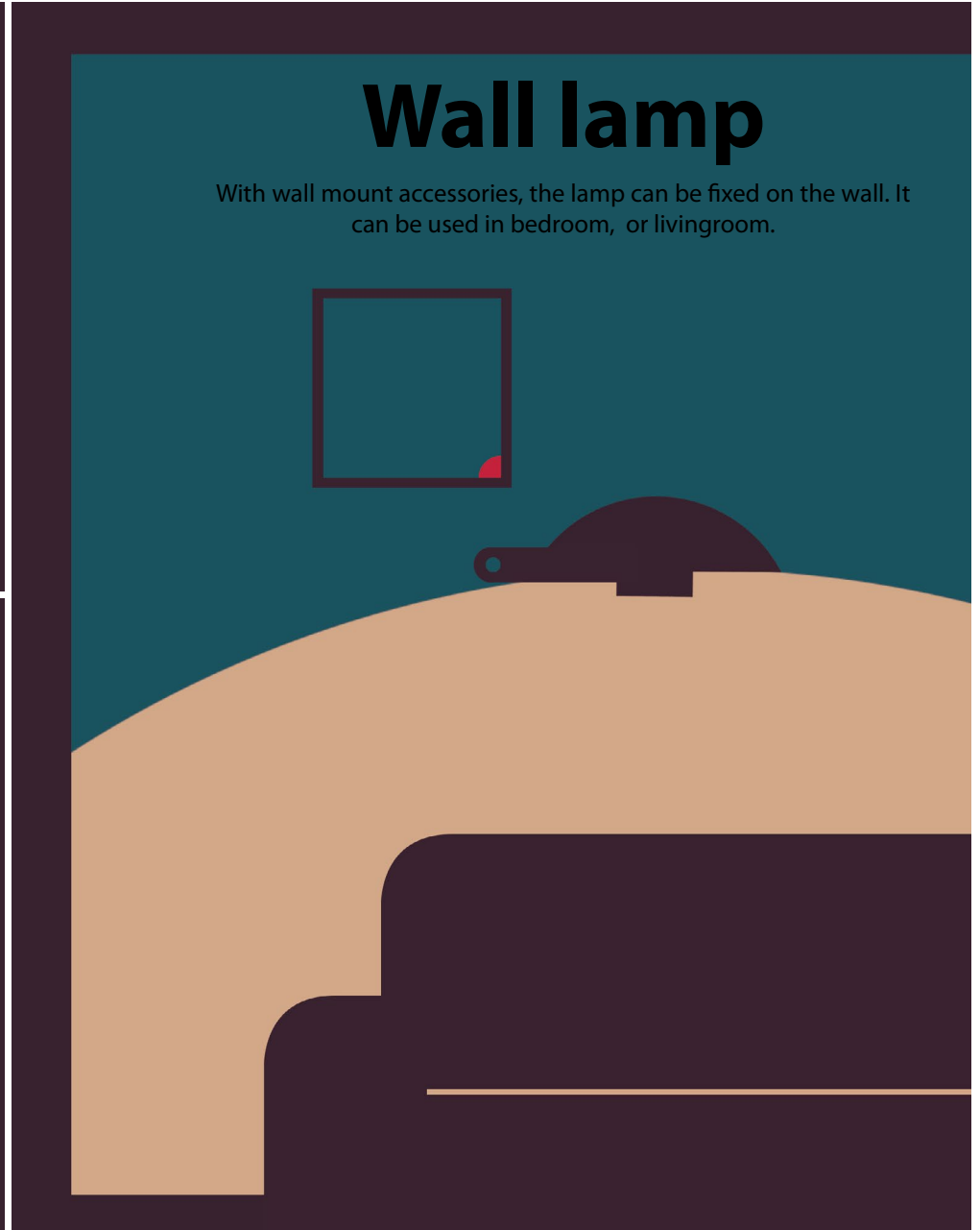
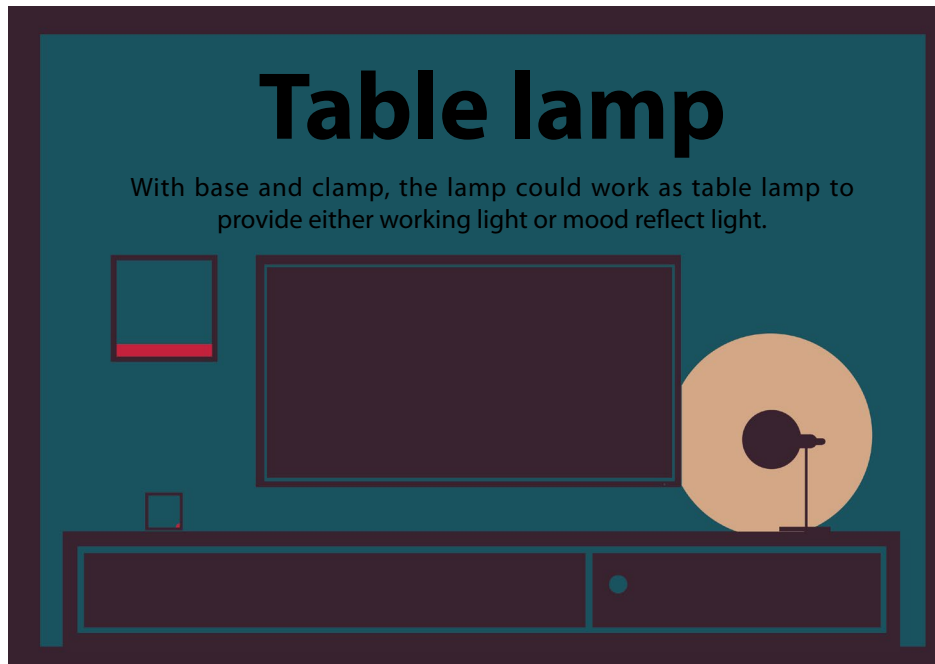
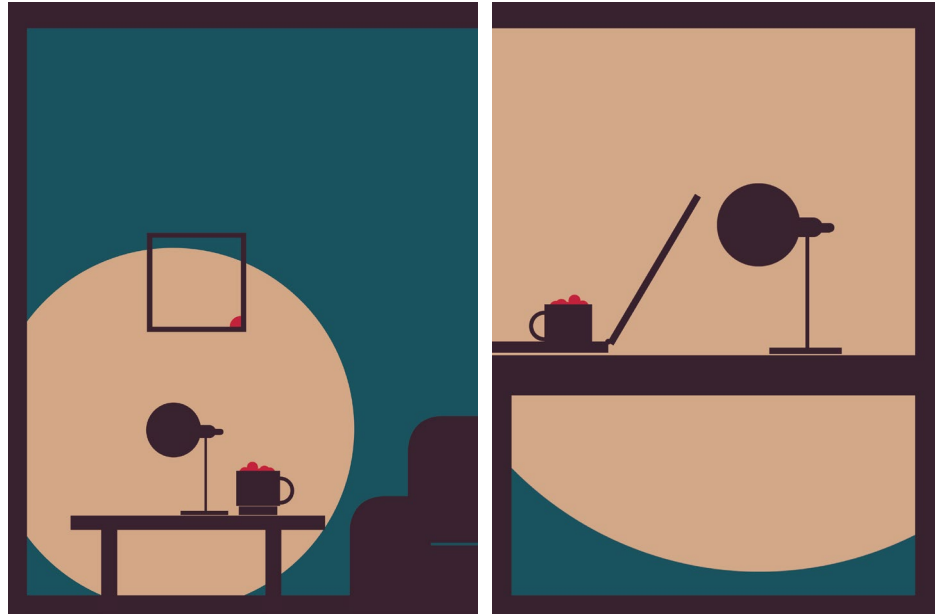



Proposal

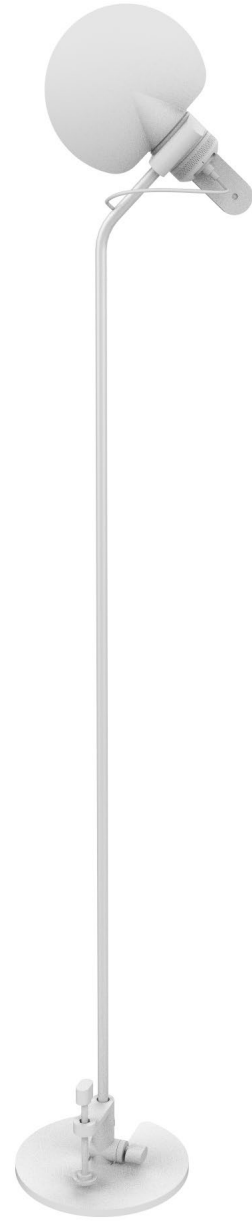



Accessories

Accessories include 4 parts, base for freestanding, clamp, wall fix, and frame.
With these accessories, the lamp can reach to many spaces.

Accessories for wall lamp.
Screws for mounting on the wall
can be hidden in the structure.

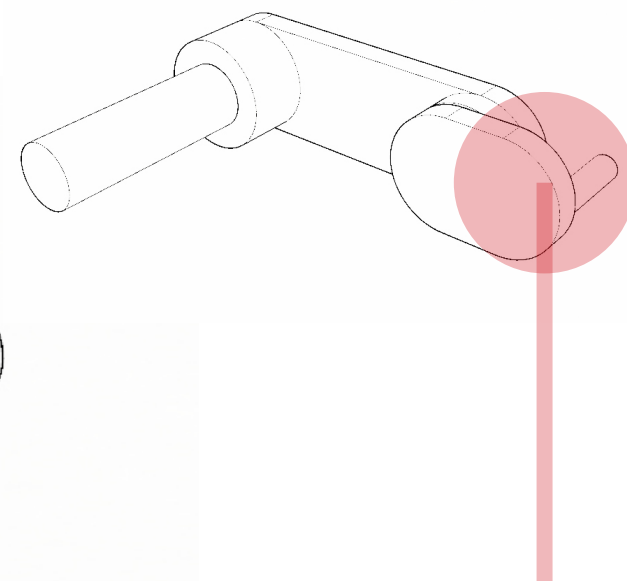
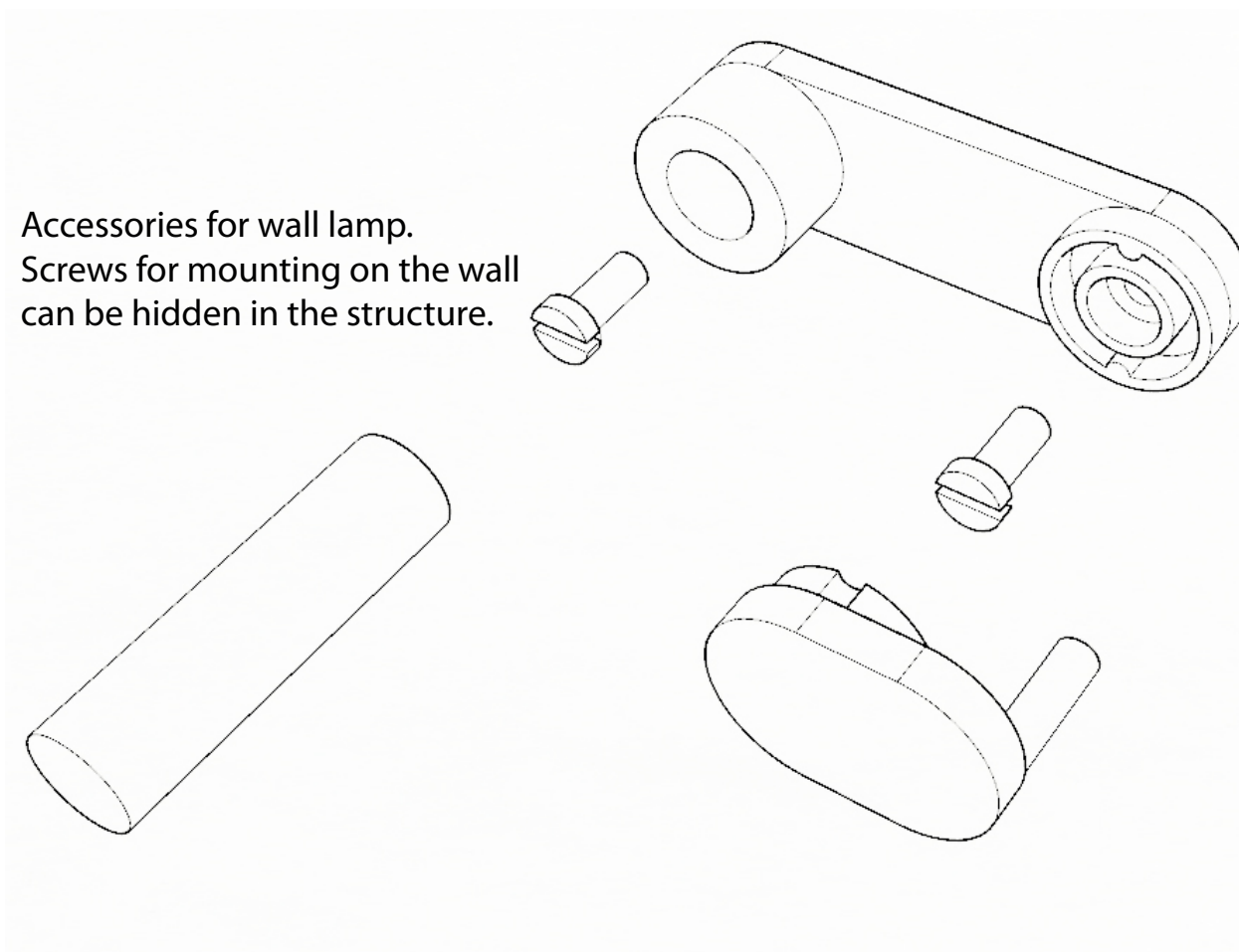

Electric cable can be organized here.



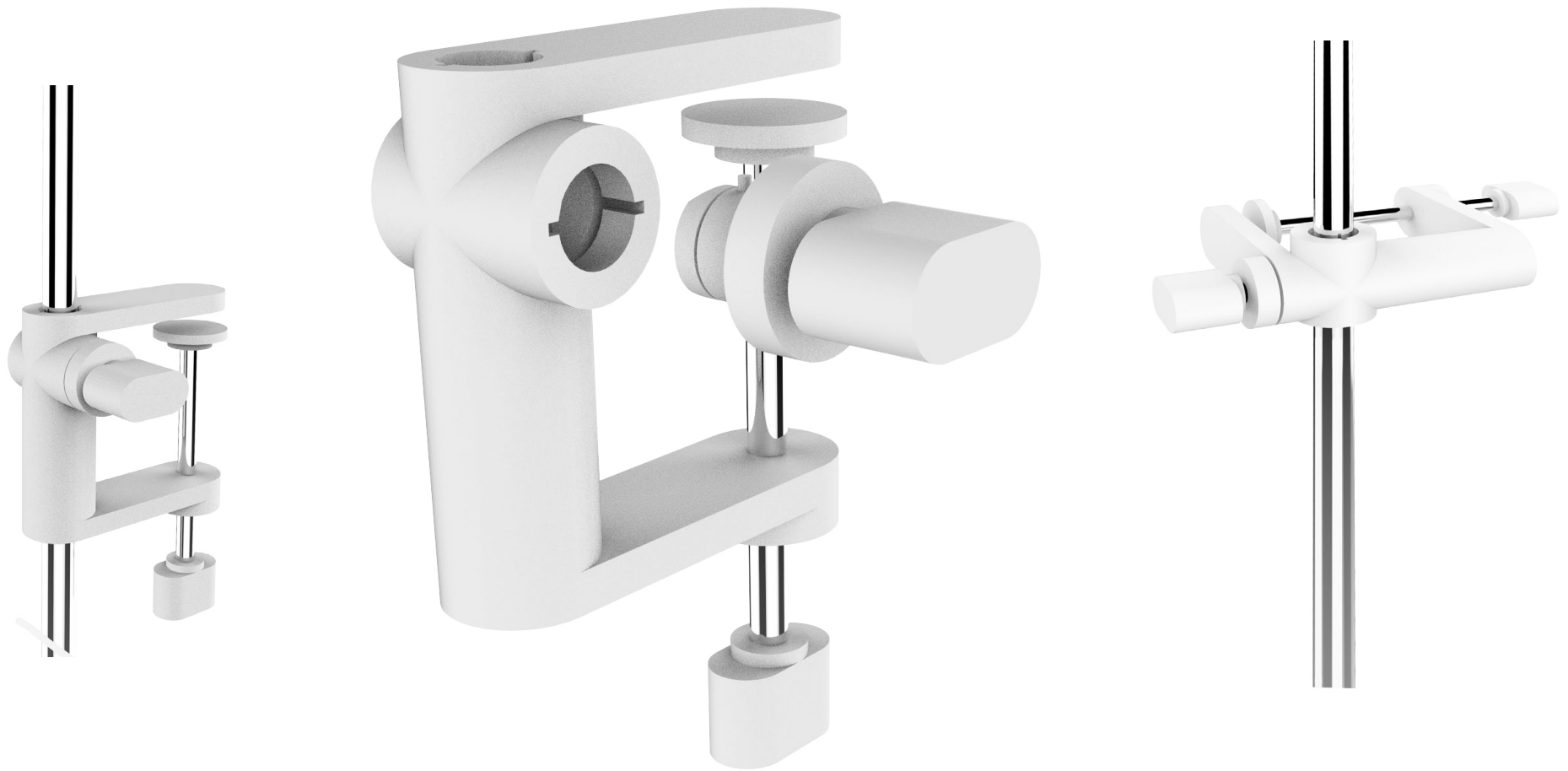

Clamp:

Fully utilize the structure, the clamp can be used in two directions. Vertical directions: clamp can be attached on horizontal platform such as table, windowsil. Horizontal directions: clamp can be attach on vertical platform, such as shelf, frame. As the frame of the lamp have to be tight and rotate, the hole which are not be used by frame, can be attach a fastener, frame can be adjusted.



500m

1350m

Base

base can be used with clamp.

frame

Frame including 2 dimensions
1350mm and 500mm

1350mm is the length for floor lamp or clamped lamp
with same height of floor lamp.

500mm is height for table lamp, as the table height
is 760mm and table lamp would be 1260mm height
from floor. it will a little lower than sitting eye level, so
that the light source cannot be seen.



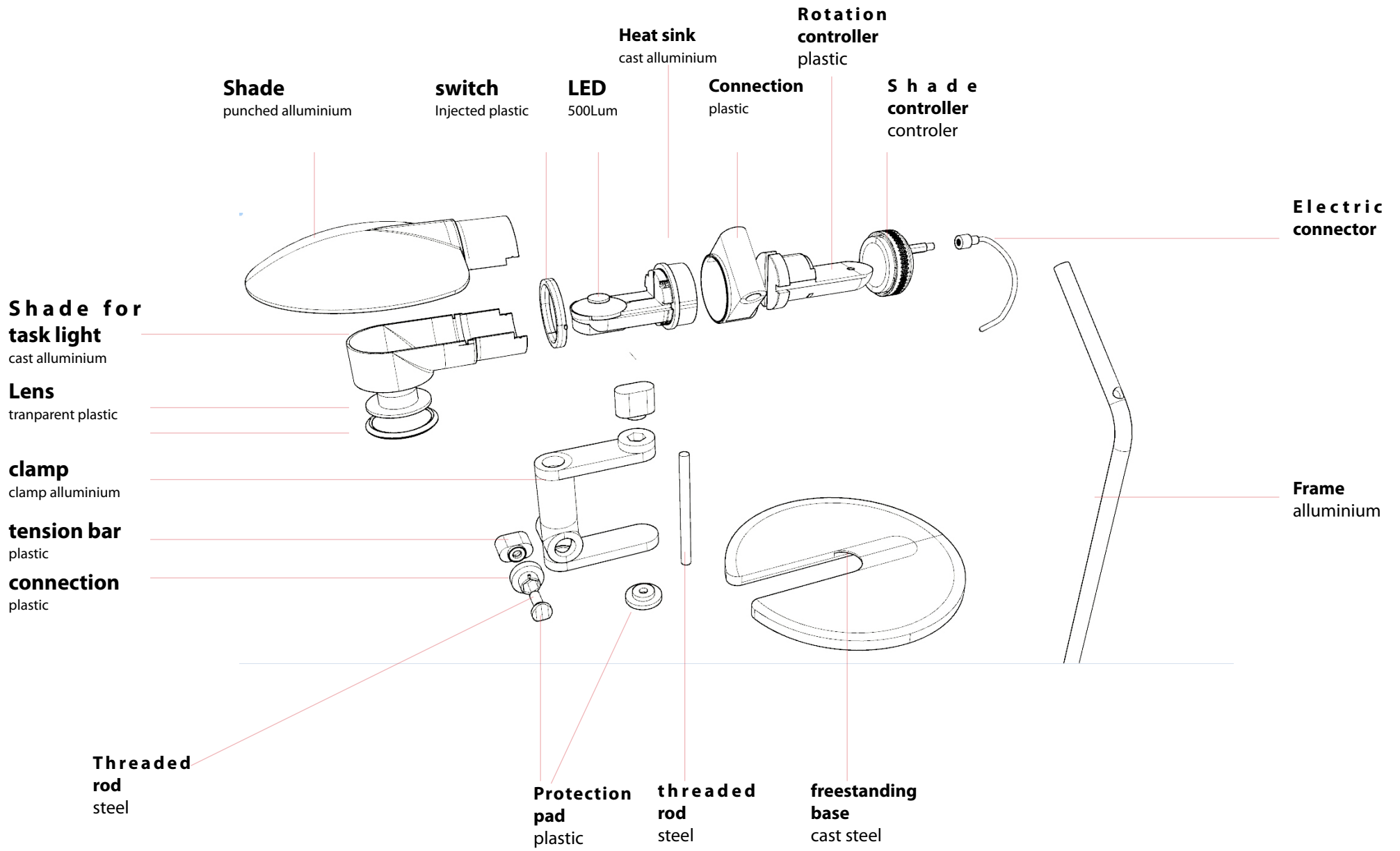

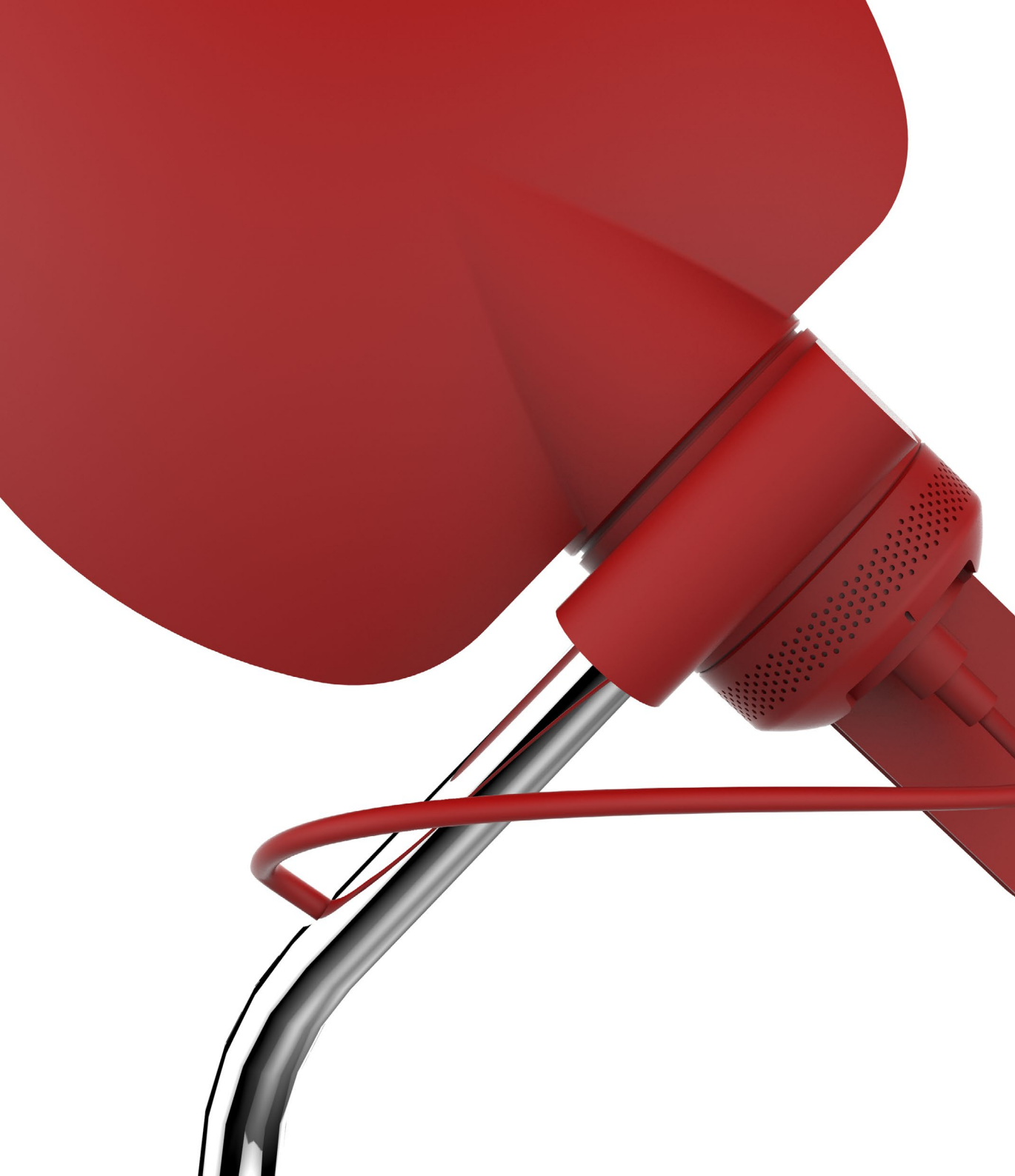

Colour

White is neat and neutral to get along with surroundings. Black and white are very basic for the lamp to be apart of the space. While the lamp can be more positive accessing spaces with different passionate colors. It also can be eye catching point in a space.



Prototype





different parts of lamps before be assembled.



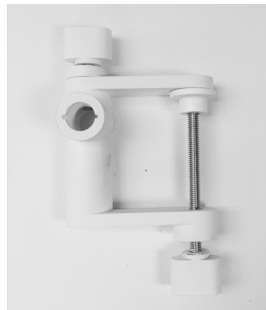
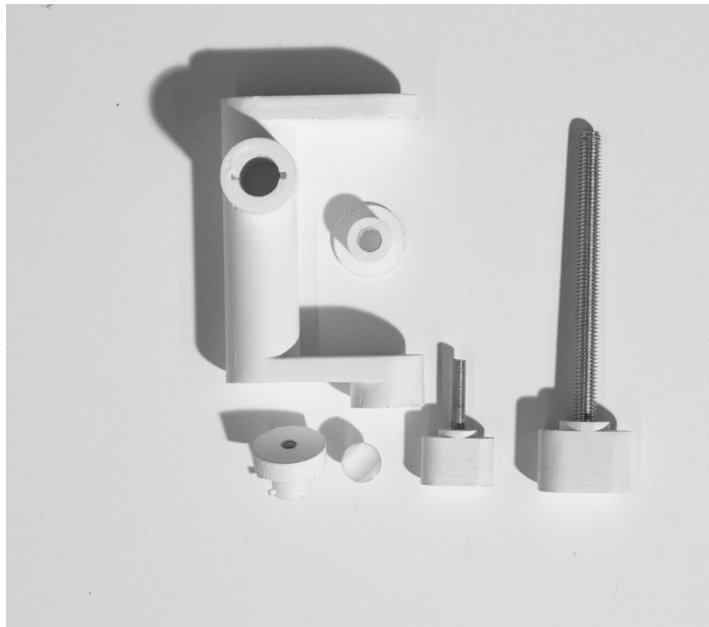



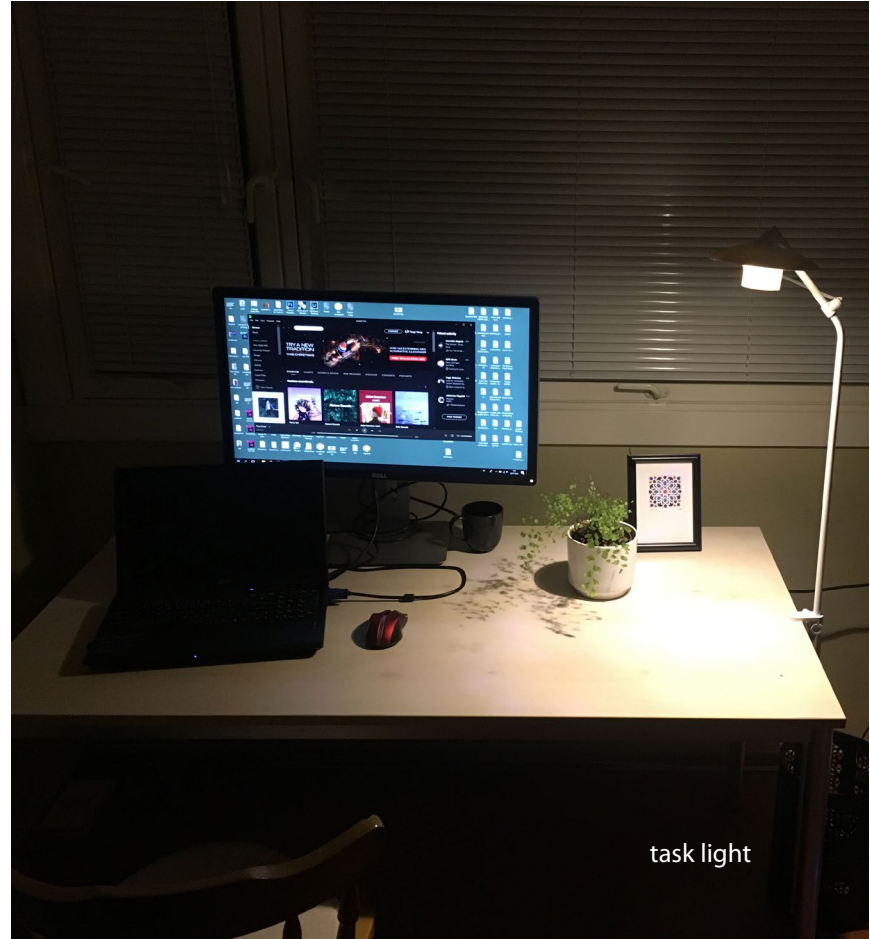
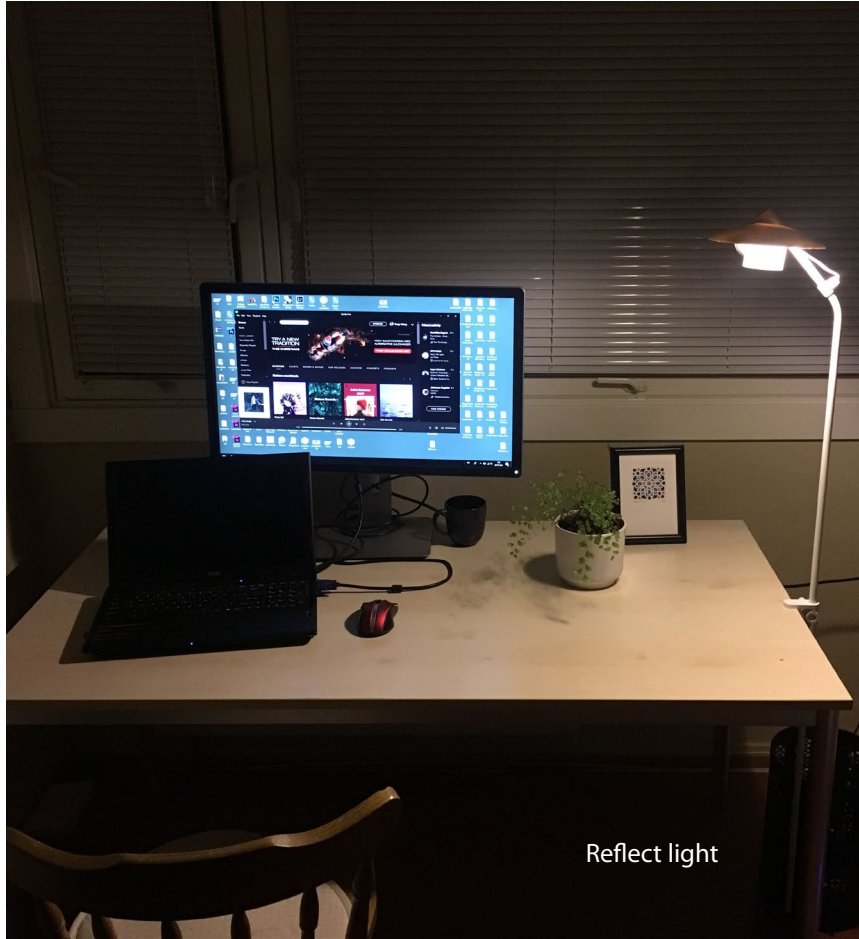

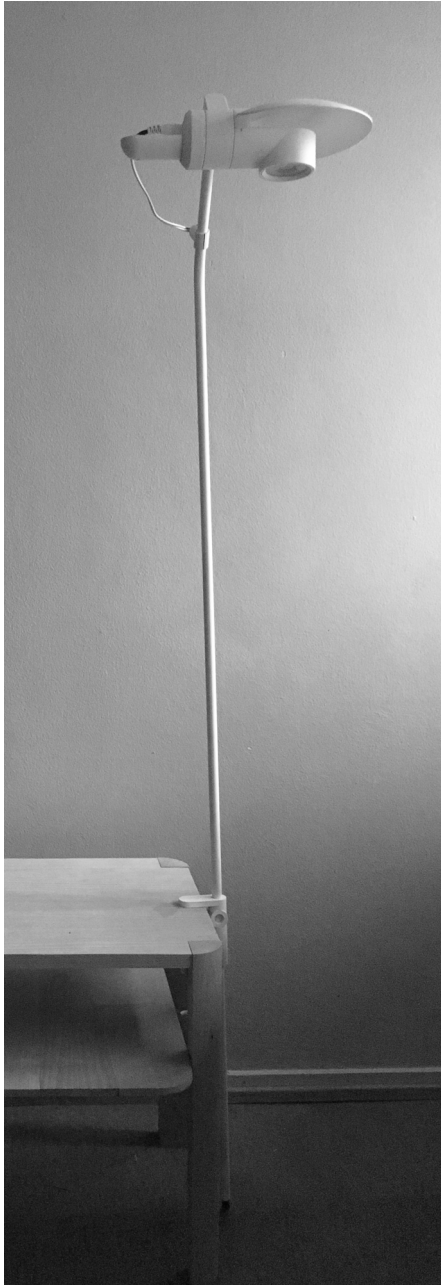



Light switch test.

Name:

Choice is the core concept in this design. With choice, the light can be changed between task light and reflect light. With choice, the lamp can access space in different ways.

OIC is the name of lamp.

It doesn't mean anything by it own, While it is the part of the word "Choice". It hint "choice" and it implies the lamp has choices and possibilities.

CH **OIC** E



Testing and feedback

from testing

Positive:

Task light can provide bright and sharp light. The clamp and slim frame works well in small spaces even with 3D printed parts. It is easy to fix or attach to environment.

Need to be modified:

There is light leak from side of the lamp, as the LED chip located on the surface of the heat. LED chip should stay below the edge of reflectors.

Led now is exposed in environment.

As the cable connector on prototype is outside too much so it occupied a lot of space, there is not so many room for finger to grip the shade controller.

It is good light for stable occasions which you don't move the lamp such as floor lamp on the corner or behind sofa. While in occasion which need to adjust light often, the structure shows the limit.

Feed back from factory

Although the factory is becoming a better factory, they still give precious feedbacks.

Shade can be produced by plastic or alluminium, while the shape of shade is deep, they cannot promise that it can be produced by punching. While it could be casted by alluminium. They are concerned that with casted aluminium the weight is too heavy. So that the shade can be made of plastic instead of alluminium.

If the lamp contains less parts that would be easier for producing.

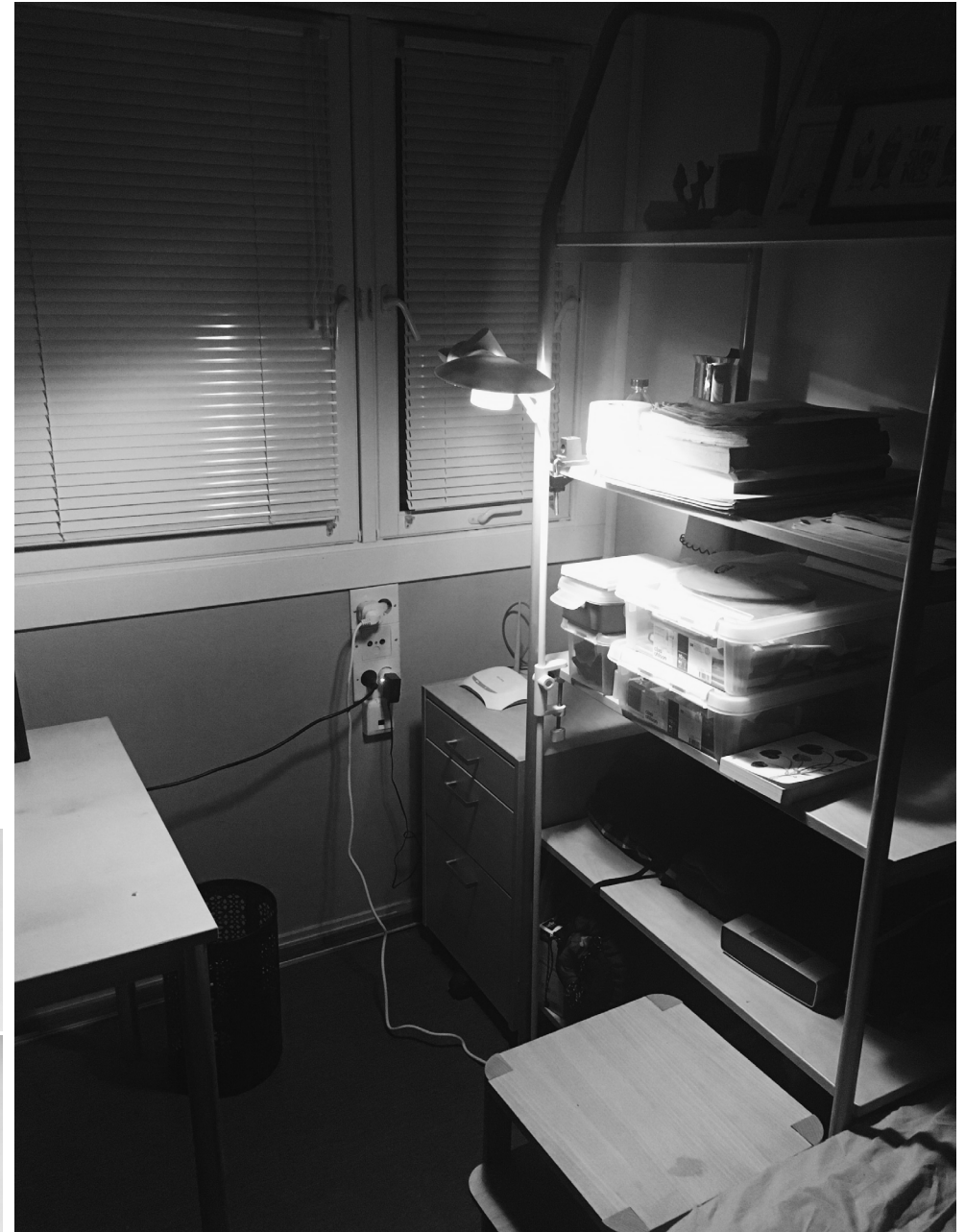
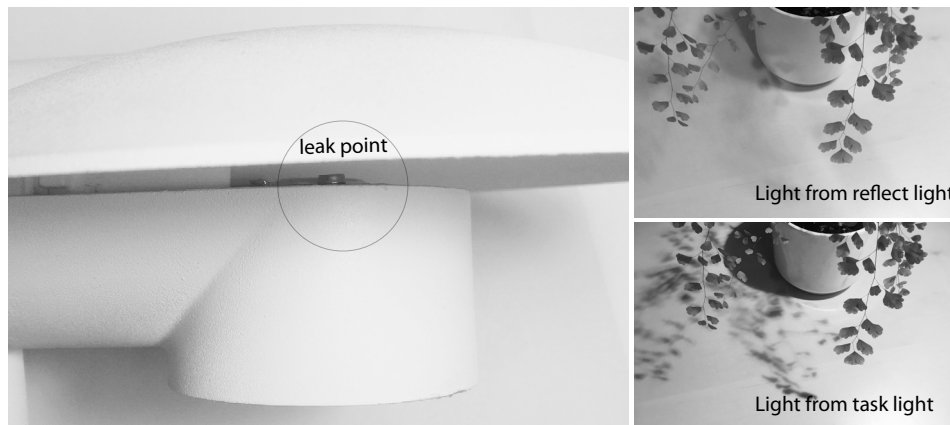

Next prototype

From initial idea, heat sink and light mod switch should be one. As I have no time to make and test heat sink in the shape which I need, so that I am using a separate heat sink for LED chip, next prototype I will bring the initial idea back to the prototype.

A step would be built on the heat sink to avoid light leak from aside, and also make a cover to isolate LED from dirt and humidity

Try to reduce the diameter of core which contains with LED, switch and cable, simple the structure.

As in this project I designed light source and fixing structure and frame for stationary occasions. It could be a good combination with working lamp frame which can provide easier free angle adjustment.



References

http://www.chinadaily.com.cn/bizchina/2008-03/17/content_6542889.htm

Compact Living Choosing to Live Small Katja Risager M.Sc. 04 ARC15 February 2015

Interior Lighting for Designers FOURTH EDITION Gary Gordon FIES, FIALD, LC 2003

Handbook of Lighting Design by Rüdiger Ganslandt Harald Hofmann

RESIDENTIAL LIGHTING 2013 TITLE 24, PART 6 A guide to meeting, or exceeding, California's 2013 Building Energy Efficiency Standards

An Introduction to The IES Lighting Handbook 10th Edition by David L. DiLaura

UK Residential Buildings; The Spatial Quality of Compact Living By Luke Riggall.

Electrolux-Report-Compact-Living-Quality-capital space 2016

Acknowledgements

Carsten Oeding Loly, Geir Øxseth, Harald Skulberg for supervising this project.

William Li from Higzip, for offering summer job opportunity and introducing factory

Shouxin Lin for introducing plastic injection knowledge

Jianye Wu for metal manufacture introduction

All technicians at the school workshops for their help

And my parents and friends who helped out whenever needed

