

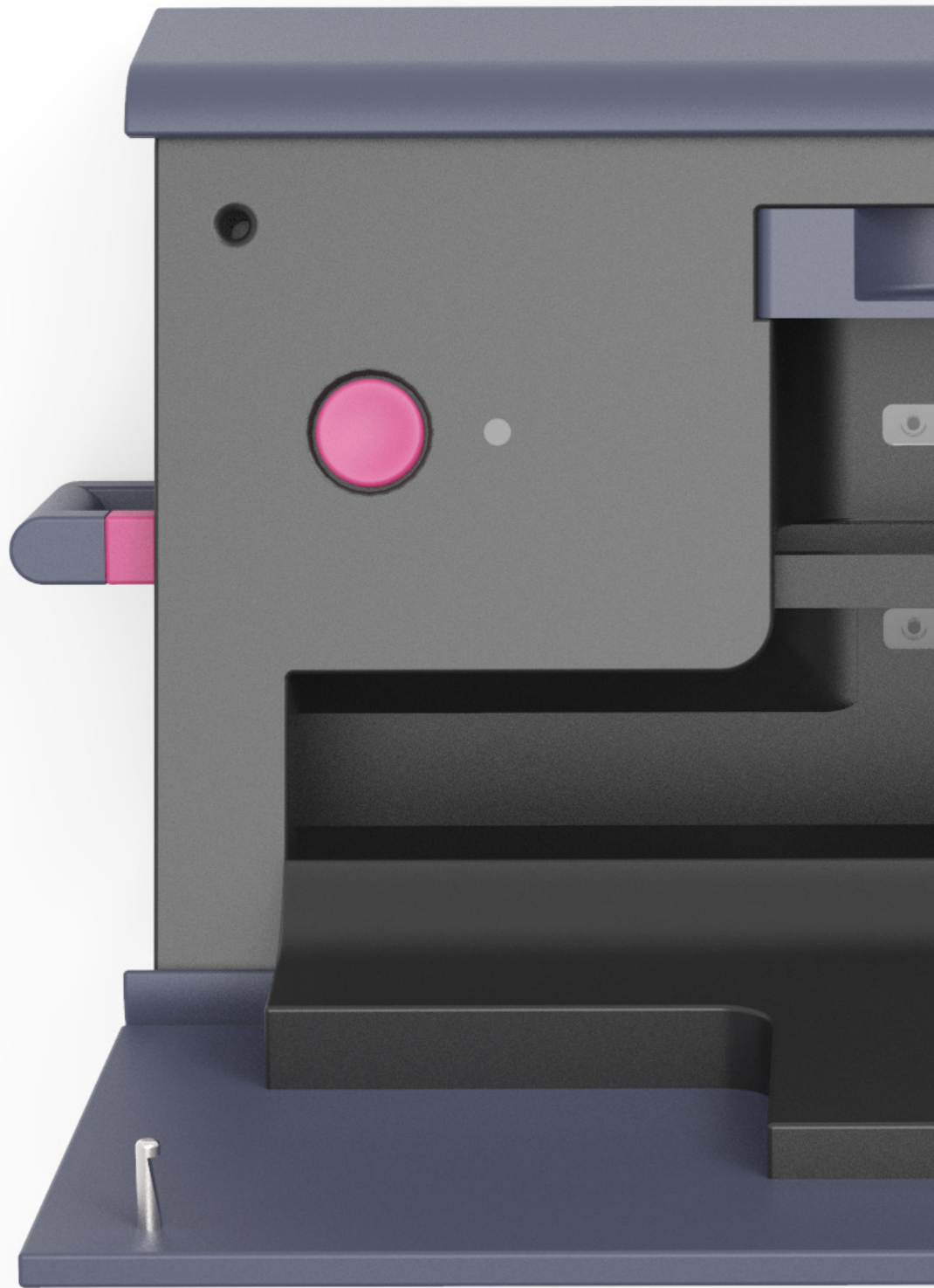

Arkitektur- og designhøgskolen i Oslo  
The Oslo School of Architecture and Design



# DESIGNING A MODERN RAT TRAP - PROJECT REPORT

KLAS HARRIS

DIPLOMA - FALL SEMESTER 2017

THE OSLO SCHOOL OF ARCHITECTURE AND DESIGN

INSTITUTE OF DESIGN



---

**PROJECT BY**

Klas Harris  
klas.harris@gmail.com  
+ 47 45 22 45 10

**MAIN SUPERVISOR**

Nicholas Stevens

**SECONDARY SUPERVISOR**

Mosse Sjaastad

# ABSTRACT

The aim of this project was to create a product or solution to combat rodents for the private market. The product has the ability to connect to a network or smart home solution so that it can notify the user when there is activity, ensuring swift removal of the rodent and more efficient pest control.

The research for this project includes looking at and analysing what traps are currently on the market, interviews with experts within the field, field work together with pest control technicians. In addition I have looked at research conducted on the humane execution of rodents.

The end result is a mechanical rat trap for outdoors and indoors use which ensures swift execution with as little suffering as possible. All the mechanics are enclosed to make it easier to handle and at the same time making the trap safe to use around pets and kids.



# TABLE OF CONTENT

3 - ABSTRACT

## **BACKGROUND**

7 - INTRODUCTION AND BRIEF

8 - PESTICIDES

9 - HUMANE EXTERMINATION

## **RESEARCH AND EXPLORATION**

12 - A DAY IN THE LIFE OF A PEST CONTROL TECH.

16 - COMPARATIVE STUDY

19 - ELECTROCUTION TRAPS

21 - INTERVIEW WITH FHI

23 - THE CONNECTED HOME

25 - WHO IS THE PRODUCT FOR

## **DESIGN PROCESS**

27 - RAT BEHAVIOUR

29 - USER SCENARIOS

31 - LAYOUT OF THE TRAP

33 - FOAMCORE MODELS

34 - MECHANICAL MODEL

36 - HANDLING OF THE TRAP

37 - SKETCHES

40 - MODEL WORK

## **FINAL PROPOSAL**

43 - 3D MODEL

45 - PHYSICAL MODEL

46 - MATERIALS AND PRODUCTION

47 - SPRINGING THE TRAP

48 - THE TRAP IN USE

## **APPENDIX**

52 - FURTHER DEVELOPMENT

53 - REFLECTIONS ON THE PROJECT

54 - REFERENCES AND SOURCES



Human attitudes to pests are often different from attitudes to other species but if we interact with these animals we have moral obligations towards them and we should consider their welfare in every management operation.

Broom DM, **The welfare of vertebrate pests in relation to their management**  
In *Advances in Vertebrate Pest management*, ed. by Cowan DP and Feare CJ.  
Filander Verlag, Fürth, Germany, pp.302-329 (1999).

# BACKGROUND

# INTRODUCTION AND BRIEF

Where there are humans there will be pests. One of the most common pests, the brown rat is not a malicious creature by definition but the fact that its habitat sometimes encroaches on the space occupied by humans makes it a pest and nuisance. Rats can cause a lot of destruction on property, they can also spread disease, this in combination with an extremely high rate of reproduction makes it necessary for us to consider it a pest, try to control the population and prevent them from entering our buildings. The way humans have dealt with pests has varied over time. Different traps and pesticides have been the weapon of choice in this situation for a long time, not just for rats but for a wide range of pests.

The problem with poison and pesticides are the effects they have on nature, we just have to look at the widespread usage of DDT in agriculture to see what catastrophic consequences they can have. DDT has been documented to cause cancer and had a devastating effect on the wildlife and was therefore banned for agricultural use in most countries in the 70's. We can see that there has been a drive for some time to regulate and minimize the usage of poison in pest control and it will probably grow even stronger in the years to come.

I feel the search for greener, safer and smarter solutions in pest control is of importance and I think that as a designer I can hopefully see things from a different perspective and help in pushing the industry in the right direction.

## PROJECT BRIEF:

Design a system, product or a range of products for rodent pest control which is a superior alternative to the use of poison and has improved usability over what is currently on the market.

The end result should provide the user with greater control over the pest control situation in their home.

# PESTICIDES AND THE PROBLEMS WITH USING RAT POISON

As mentioned in the introduction the use of poison has been a common way of combating rodents since they first appeared on the market in the 1940's. And it is still to this day a common method both among the professionals as well as in agriculture and in the private market.

The most popular types of poison is anticoagulants. The way that they work is that they stop the blood from coagulating and after a sufficient amount have been digested the poison will cause internal bleeding in the animal. The poison usually comes in the shape of a wax block to dilute the chemicals and make it easier to handle.

It is not hard to see why it is popular, compared to setting traps you can more or less forget about it and refill the poison every once in a while. In addition to being convenient the cost is quite low.

But there is a different price to pay. Studies have shown that the poison finds its way into the ecosystem. Since rat poison normally takes some time to accumulate in the body of the rodents they can become the prey of birds, cats and other animals that often hunt rats and mice.

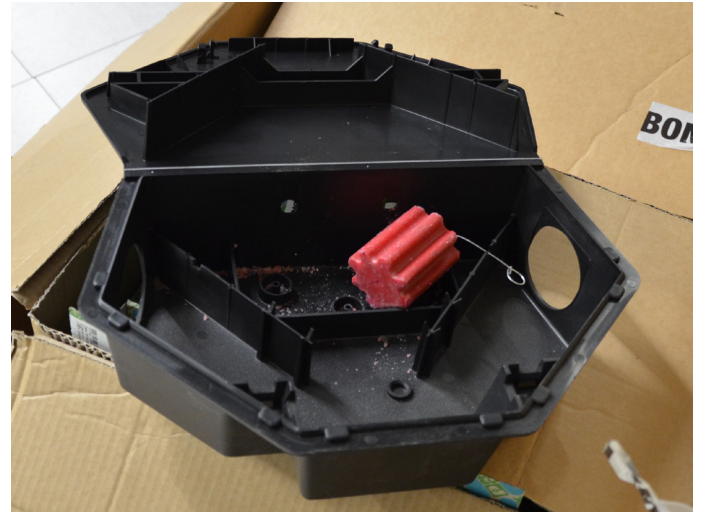

A standard rodent bait box with its lid open, inside we see a wax block containing Bromadiolon, a common type of rat poison.

Another issue that comes with the slow working poison is that when the rat eventually becomes ill it will seek out the safety of its nest which in urban areas often is within our buildings. This is a big problem for homeowners since a dead rat inside the wall can create an unbearable stench. It's usually hard to pin point exactly where in the wall that the decaying rodent is so in many cases you have to open up a whole wall just to get rid of the body and in some cases also replace soiled insulation materials.



It is mandatory for the pest control companies to post warning labels whenever poison is used in the extermination process.

## SOURCES:

Katherine H. Langford, mfl: **The occurrence of second generation anticoagulant rodenticides in non-target raptor species in Norway**, Science of The Total Environment, Volumes 450–451, 15 April 2013

**Så farlig er musegift for andre dyr** - <https://forskning.no/husdyr-miljogifter-rovdyr/2016/11/musegift-farligere-enn-tidligere-antatt>

# HUMANE EXTERMINATION OF RODENTS & REGULATING THE USE OF POISON

## What the laws says about the humane treatment of rodents.

There are laws in place in Norway, as in many other countries, that ensures fair and humane treatment of animals. They are called dyrevelferdsloven (the animal welfare law) and viltloven (the wildlife law). These are laws that you must follow if you are a professional farmer wanting to kill and butcher a pig or if you as a private citizen are out in the forest hunting deer. Even though rats and mice in principle fall under these laws they also seem to exempt.

You are allowed to use traps which causes a lot of distress and suffering in the animals such as drowning traps and glue traps, these are traps that are banned in Sweden. There also seems to be a lack of regulation on other traps that we find on the market. Some mechanical traps don't generate enough force to consistently kill its victims, instead they often end up wounding the rodent or causing a prolonged and painful death.

Then there is also the extensive use of poison in combating rats and mice. Killing any other animal with the use of poison and chemicals is strictly forbidden. The most common forms of rat poison are anticoagulants which over time causes internal bleeding.

There is no definitive answer as to why rats and mice are exempt. It could be that since they are considered vermin their well being is not really considered. Perhaps it is a lack of attention from animal welfare groups. Or it could be that the damage these creatures cause to property and infrastructure justifies the use of not so humane methods.

The Veterinary Institute does advocate the banning of certain types of traps and a better control over what traps gets sold here in Norway. They conducted a study in 2010 looking at different types of mouse traps and the use of poison in combating rodents. They also recommend a re-



The law governing the use of correct methods in pest control in Norway.

duction in the use of rat poison due to the pain and suffering it causes the rodents.

But of course we can't escape the fact that we

*When an animal dies, welfare ceases and if consciousness is lost instantly and not regained before death, there is no welfare problem. However, when an animal dies slowly after being shot, trapped or poisoned in a way which causes pain, fear or distress, its welfare is very poor*

Broom DM, *The welfare of vertebrate pests in relation to their management* In *Advances in Vertebrate Pest management*, ed. by Cowan DP and Feare CJ. Filander Verlag, Fürth, Germany, pp.302-329 (1999).

must deal with rats and mice somehow. So what is the most humane way of extermination? For an answer we can look at a study from 1999 called *The welfare of vertebrate pests in relation to their management* which goes into detail of different extermination methods from an animal welfare perspective. The conclusion being that if the method causes instantaneous loss of consciousness we can assume that we are not

inflicting any suffering in the animal. In practice this requires a mechanical trap to provide a swift blow to the head or neck of the animal of sufficient force to cause instant death. In an electrocution trap we need to provide a large enough electro shock through the vital parts of the animal (brain or heart) to cause instant loss of consciousness

## THE PRINCIPLE OF SUBSTITUTION

The person undertaking pest control is obliged to use the means and method that does the least amount of harm to health and environment and which leads to the desired result.

Forskrift om skadedyrbejempelse (2001) - Helse- og omsorgsdepartementet

### About the laws and regulations in Norway surrounding pesticides.

There is a distinction between products for private and professional users. Products for private use are products that you can buy and use for example at home or in the cabin without having any education or special qualifications in pest control. Products for professional users are products that you can buy and use only if you have a pest control certificate issued by Folkehelseinstituttet.

Since 2014 private individuals can no longer buy the more potent second generation rat poison, only mouse poison that must come pre-packaged in small bait stations. Pest control technicians can still handle the more potent chemicals but the use is regulated. They must for example always use lockable bait boxes when placing poison indoors or in a public space.

When you talk to people in the field of pest control they tell you that there has been a shift. Before the use and handling of rat poison and other pesticides were rather haphazardly treated. Where as today there is a more responsible approach among the technicians as to when and how you use poison in the pest control process. This comes from stricter regulations (like the principle of substitution) and better training of new technicians.

### SOURCES:

Engeland S, Kjæstad HP, Grøndahl AM, Karlsson AC, Mejdell CM. **Dyrevernmessige konsekvenser ved bekjempelse av rotter og mus.** Veterinærinstituttets rapportserie 12-2010. Oslo: Veterinærinstituttet; 2010.

Broom DM, **The welfare of vertebrate pests in relation to their management.** In Advances in Vertebrate Pest management, ed. by Cowan DP and Feare CJ. Filander Verlag, Fürth, Germany, pp.302-329 (1999).

**Salg og bruk av muse- og rottegift** - Miljødirektoratet, faktaark M-619, 2016

# RESEARCH & EXPLORATION





## A DAY IN THE LIFE OF A PEST CONTROL TECHNICIAN

To get a feel for how the professionals handle pest control I decided to tag along with two pest control technicians for a day. I met up with Jørgen and Stian, two friendly guys working at the Anticimex East office (Oslo, Akershus and Østfold). Jørgen has been in the field for twelve years and goes by the title of service technician. He has a lot of contact with some of the larger customers in addition to coordinating work with his fellow pest control technicians, such as Stian, who has been working as a pest control technician for the last three years. The plan for today is the installation of two smart systems in two very different locations in Oslo.



Preparing the I-traps for installation.

The smart systems that Anticimex use are for exterminating rats and mice, they are battery operated units which can remotely report activity over the common cellphone network. Depending on the size of the infestation and if its indoors or outdoors they use two different systems. For indoor location they usually install the smaller I-Trap produced by a company called Wisecon which kills the rodents via a spring loaded mechanical arm activated when two

IR sensors detects motion. It lures its victim with replaceable scent pods. Each I-Trap has to be connected wirelessly to a master unit placed nearby which contains the SIM card, the master unit also has a control panel for when the technician is on site and need to diagnose the system. Outdoors they use the larger Smart Box unit which can operate without the need of a central master unit since each box has its own SIM card. As opposed to the I-Trap the Smart Box



A technician putting batteries into a new I-trap



Installing the I-traps among the wiring beneath the floor





Master unit up and running. Ready to report activity over the cellular network.

kills the rodents through electrocution. The first stop of the day is a large relay room belonging to a company in charge of maintaining the infrastructure of the Norwegian railway. The room is jam packed with switches and other electronic equipment controlling the railway network of the whole country and there is a constant humming, clicking and whirring going on in the background. If there is one place you do not want a rat to chew over a cable this is it. I am told to not touch anything while the guys get to work opening up floor panels finding



Installed Smart box with wall mount.



Before leaving the location the technicians make sure that all units have connected to the system.

## PEST CONTROL IN NORWAY

To become a pest control technician you must complete a course held by Folkehelseinstituttet. The course contains both theory and practical field work. Every technician will have to take a renewal course after 10 years.

Only approved technicians can use the title and are allowed to handle certain pesticides. A list over who is approved are listed openly to the public.

Pest control companies offer their services for both private and corporate customers. A corporate customer usually signs a yearly contract which includes a set number of visits and in addition the technician will be available on call.

Most private customers comes into contact with a pest control company through their home insurance.

A normal home insurance will cover the extermination once the rodents are inside the building but they must cover the cost of preventative measures themselves.

suitable placements for around 10 traps, replacing the old bait boxes containing rat poison with a more high tech solution fitting of the location.

The techs tell me that they have noticed a significant upswing in the last year of customers opting to go for these smarter products instead of the normal boxes with rat poison. The fact that the smart traps are poison free is a big selling point but Jørgen tells me that the feedback he gets from customers is that they like how the rodent problem gets much more tangible. They can get exact reports of when and where there



Unloading the Smart boxes at the second location. A special key is required to open the traps.



is activity and the extent of the infestation, sometimes the actual numbers surprise the customers he tells me.

After lunch we head over to our second location for the day. This time a private customer living in one of the wealthier neighbourhoods of Oslo. They had observed rats in the garden and wanted the best solution on the market, price was clearly not an issue. After surveying the property they decide where to mount the boxes, seven in total. The traps are usually placed along a wall and they have a tunnel along the bottom which exploits rodents natural attraction to small confined places. Once inside the tunnel the victim gets electrocuted and dumped into a small bucket inside the box. The technician gets alerted

and comes and empties the trap when one or more rodents have been dealt with.

The contracts are usually the same for both private and industry customers. They pay an annual fee and they have a set number of visit from the technician throughout the year plus any additional visit prompted by either the customer or the smart system notifying about activity. Private customers opting for a smart solution is a rarity though. Having one Smart Box, let alone seven, is a lot more expensive than going for the traditional bait boxes filled with rat poison. But the technicians are convinced we will see a lot more smart solutions installed in the future, perhaps spurred on by stricter environmental regulations.

### LOCATION 1 CORPORATE CUSTOMER

- Technological building
- Rat droppings found under the floor
- Indoors
- Wisecon Smart I-Trap system for indoors
- 10 Units + 1 Master unit



Wisecon Wise-I trap and Wise-I Master



### LOCATION 2 PRIVATE CUSTOMER

- Residential area
- Rats observed in the garden
- Outdoors
- WiseBox for outdoors use
- 7 Units



Wisecon Wisebox 1

# FINDINGS FROM FIELD STUDY

After visiting two locations, conducting quick interviews and observing how the technicians work I was also able to make the following observations:

- Using modern technology provides a higher degree of control for the end user. “the rodent infestation became more tangible and easier to track with precise numbers”.
- The Smart boxes which can store several dead rodents are a bit overkill for a small residential customer. They are big and bulky and because of the smell the collection several rodents isn't necessary since you want to empty it as soon as one rat is caught.
- The technician tried hiding the traps, afraid they would be an eyesore for the customer. I see an opportunity to create better looking traps.



## EXISTING TRAPS ON THE MARKET

An important part of my research was to look at what type of solutions that currently exist on the market.

We can categorize the traps into the following groups:

**Catch and release.** These are non lethal traps where the rodent is captured in a cage or bucket and the user must then transport the living animal to a suitable location and release it into the wild again.

**Mechanical execution.** These traps are often spring loaded and are designed to kill the rodent. They can for example work by giving a killing blow to the neck or head, or by choking the rodent to death.

**Electrocution.** These traps use electric current to kill the rodents.

**Glue traps.** A flat surface of glue with bait in the middle. Killing trough asphyxiation or starvation.

**Drowning traps.** A seesaw or cylinder with bait causes the rodent to fall into a bucket of water.

**Gas traps.** Killing the rodents trough asphyxiation with the use of CO2.

Glue and drowning traps are considered very inhumane in the way that they kill the rodents so I didn't look very closely at those. Catch and release while being the most humane way of dealing with rodents is often not a viable option if you live in an urban environment. Killing through the use of gas is considered humane but is very rarely used, in fact I have only come across one trap that uses this method. Perhaps

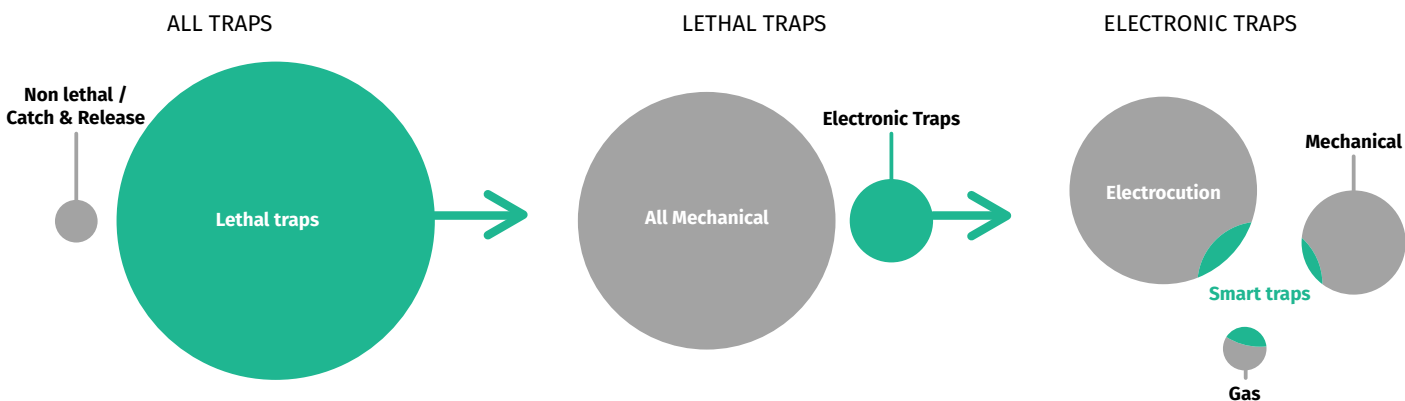

Sorting and categorising the traps on the market: The majority of all traps are intended to kill its victim. Out of these lethal traps most are mechanical but some use electronics in various ways. Out of the electronic traps only a handful are what we can categorise as Smart traps.

this is due to technical constraints or it can also be because of the connotations you get from a “rodent gas chamber”.

So the types of traps I looked closest at were the mechanical traps and the ones that uses electrocution. I looked at both rat and mice traps since they often work in similar manner just at different scales.

I paid closer attention to the traps that use electronics. These come in all shapes and sizes, from the small ones for the home owner with a mice in the attic to the large rat traps for industrial use with the capacity to kill several rats before you have to empty the trap.

There is a sub category of electronic traps which one could call smart traps. These are traps with connective capabilities. That could be either through radio, such as Bluetooth or Z-Wave or they connect to the cellular network through a SIM card. This gives them the ability to notify the user when there has been activity or the trap needs service or a change of batteries.

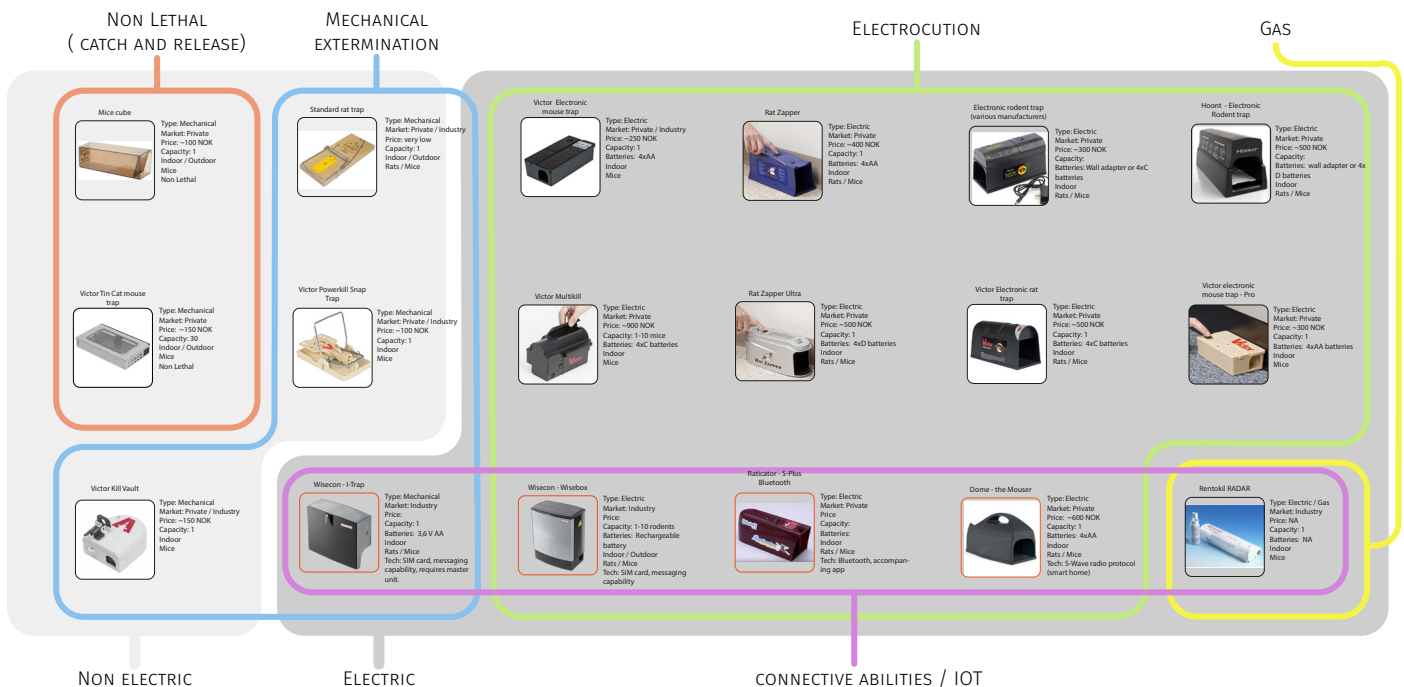

A small cross section of the traps currently on the market but with more focus on the electronic traps.

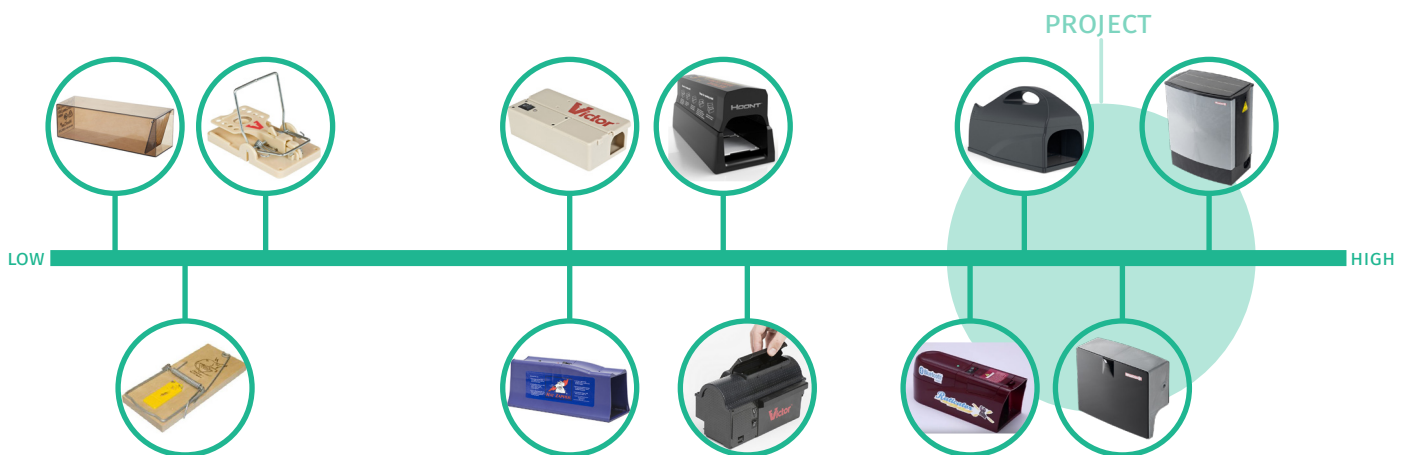

Sorting products already on the market in terms of complexity. Simple mechanical traps to the left, electronic traps in the middle and Smart traps to the right. My product will be in the smart trapcategory with quite a high level of complexity.



# FINDINGS FROM COMPARATIVE STUDY

By looking at what is already on the market I drew the following conclusions.

- A trap for rats will be able to kill mice as well. But mice traps are usually too small or not powerful enough to be able to properly kill rats.
- The traps that electrocute that use standard batteries (AA, D, C cell etc.) seem to use a lot of batteries. Looking at reviews you will have to change the batteries more often than the producers claim.
- Most traps are for indoor use only. By designing a trap that can be used both indoors and outdoors I can offer something others traps don't.
- I can only find a handful of "smart" traps on the market, that is traps which can connect to a system. I predict this will be a growing market in the time to come.

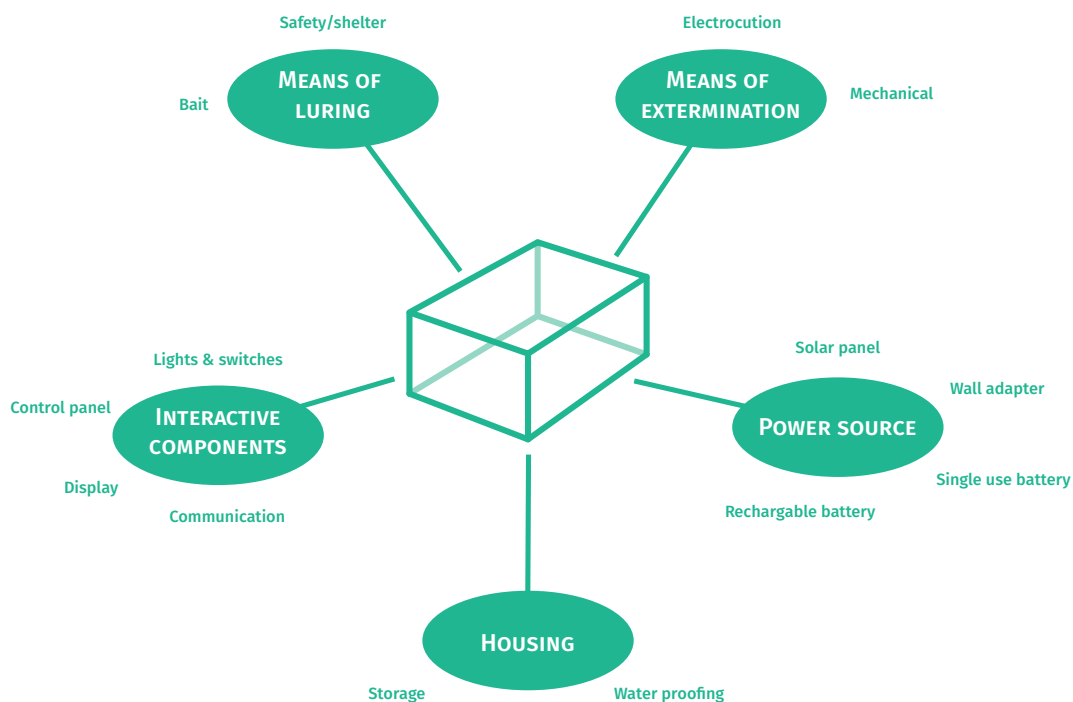

A breakdown of the components that makes up the modern rat/mice trap. These are all things that need consideration in my final design.

# THOUGHTS ON THE USE OF ELECTROCUTION IN A RODENT TRAP

At first I was intrigued by the use of electrocution as a method of extermination. A lot of newer traps on the market offer this solution and claim that it's quick and easy and requires less clean up compared to conventional traps. But after studying them a bit further I found out that a good electrocution trap both in terms of efficiency and humane killing have certain requirements that a lot of the traps lack. It boils down to two crucial points:

1. the layout of the electrocuting components
2. How much power the trap can deliver.

If we look at the first point, the layout of the trap. In order to provide a swift execution and to do so in a humane fashion the current needs to travel through either the heart or brain of the rodent. When this happens there is a quick loss of consciousness and the rodents will not suffer. But most of the traps on the market today are mostly just two metal plates on the floor of the trap, when the rodent steps on both plates it completes the circuit and receives an electric shock. Since the current takes the path of least resistance, in this case through the body of the rodent, and only the feet are touching the metal then the current will not pass through the heart or the brain. This will result in the rodent being conscious for longer and therefore the rodent is potentially in more pain



Here we see a rat trap called *Hoot* with the top lid removed. Inside we see two metal plates which will electrocute the rat when it steps on both at the same time



Advertisement for a generic electrocution trap. These are available through Amazon and go by a slew of different names.

before succumbing to the electricity.

The second part of the equation is how much power the trap can deliver. The traps work by charging a capacitor which when a circuit is completed releases a lethal electrical shock. The severity of the shock is dependant of both the voltage and current being delivered. Almost all the traps on the market are battery operated, often by normal household batteries like AA or D cell batteries. These batteries gets depleted fast when the need to charge a capacitor to a threshold of 6000 – 10000 Volts. Therefore it is questionable if they can provide a lethal shock after the first few kills. Meaning that the rodent instead of dying receives a painful paralysing shock for a few seconds.

A notable outlier among the traps that I looked at is the *Wisebox* produced by the Danish producer *Wisecan* which seems to check both boxes. It has a large battery and it is designed so that the current will go through both the head and the body of the rodent.

## Environmental concerns

There is also concerns regarding the use of batteries in most of these traps. Most of them run on normal household batteries and I guess the argument for that is ease of use. But looking through reviews on Amazon it becomes clear that they seldom deliver on the number of kills that they claim can be obtained before changing the batteries. Which means if you aren't using rechargeable batteries they are hardly environmentally friendly.

I will use batteries in my own trap but since they will only need to provide power to a couple of sensors and the electronics that connect to the network I hope to minimize the impact.

## Practical concerns

Since the aim was to design a trap for outdoors use I have to consider that the trap over time will be exposed to dirt and water. This also speaks against the use of electrocution since there is a chance of electrical malfunctions if the trap is not sufficiently secured against the elements.



The Smart box by Wisecon. The only reliable electrocution trap according to the experts at Folkehelseinstituttet.

1. The rodent enters the trap and is captured.

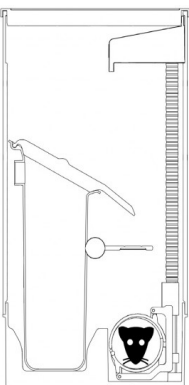

2. The rodent is quickly killed with an electric current.

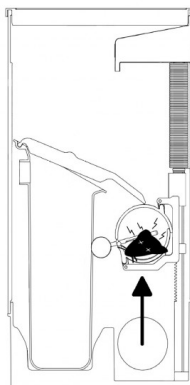

3. The dead rodent is dropped in the built-in waste bucket.

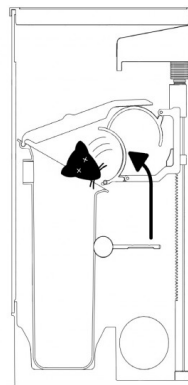

4. The trap is ready to capture the next rodent.

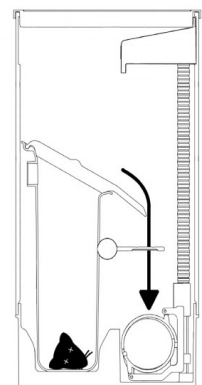

The inner workings of the Smart Box. The trap has prongs which the rat is hoisted up into ensuring that the electric current goes through the head causing swift loss of consciousness. The trap can hold 5-7 rats before it has to be emptied by a technician





# INTERVIEW WITH FOLKEHELSEINSTITUTTET

To get some more insight into rodent behaviour and pest control in general I decided to go to Folkehelseinstituttet and talk to an expert within the field.

Arnulf Soleng is a senior researcher at Folkehelseinstituttet and is among other things in charge of teaching aspiring pest control technicians about rodents and other vertebrates as they go through the process for getting their certification. These are some of the topics that we discussed.

## **About the laws and regulations governing rat poison in Norway.**

Norway more or less follows the EU directives and every five years every substance used in pest control goes up for review. It is not unthinkable that the use of rat poison will be banned completely in the future but for that to happen there must be better alternatives in place that does as good job as the poison at killing and controlling rodent populations and at an affordable price. This is in relation to the Principle of Substitution.

A major regulation in recent time in Norway was in 2014 where it was decided that private individuals weren't allowed to buy second gen rat poison in bulk. They are still allowed to purchase it if it's a set dose contained inside a bait box, to prevent over dosing and lose substances poisoning peoples and animals. FHI are among other things tracking the number of cases of poisoning among children to see if the new regulation will



## **WHAT IS FOLKEHELSEINSTITUTTET?**

Folkehelseinstituttet is a government agency under the Ministry of Health and Care.

They do research and provide their expertise in a number of fields such as

- Communicable Diseases
- Mental and physical health
- How environmental factors affect our health
- Health promoting and preventive measures in the population

They also supply the course that aspiring pest control technicians must attend to be able to use the title.

lead to a decrease of poisoning cases ( usually around 50-100 cases per year ). They have yet to reach a conclusion whether or not there have been a change.

## **About humane extermination.**

There are no direct regulation on rat traps in Norway in regards to safety and if the trap is able to exterminate in a humane fashion. Although pest control technicians under law have to make sure that they use the tools and techniques that ensure humane extermination.

### **Can traps that use electrocution kill the rodent in a humane way?**

Optimally electricity should go through the brain or the heart of the animal to ensure instant loss of consciousness. Some of the traps on the market might not have enough battery power in addition they often rely on two plates that the rodent stand on meaning the current might not pass through the heart or brain.

Mechanical traps that use force, by hitting the animal on a vital part (neck, head or upper body) is not without issues either since you must ensure that it provides enough force and won't hit the animal in parts of the body that only cripples them or inflict unnecessary suffering.

### **About the layout and choice of material.**

We also briefly discussed the shape of the trap if it would be beneficial to have it laid out as a tunnel with openings in both ends. Since the trap will be placed next to a wall where rodents travel it will probably make the rats more inclined to enter the trap if they can see the exit on the other side as opposed to a closed off trap with only one opening. Mice being more curious will enter just about any hole, so for them it won't matter much.

What material the trap is made out of could be of importance in whether the rodent chooses to enter or not. Arnulf had heard from technicians that rodents can be less willing to enter a metallic trap during cold weather. This could be because the rodents find the bare metal too cold but he couldn't say for sure. But I will need to take this into consideration when it comes to choosing materials. Using plastic or wood will potentially be more inviting for the rodent and in return lead to a higher kill rate.



Arnulf Soleng  
senior researcher at Folkehelseinstituttet

# THE CONNECTED HOME

The term Smart Home has become a lot more more ubiquitous in recent years. Smart Home Hubs like the SmartThings (now owned by Samsung) certainly broke the ground but a lot of the credit goes to the tech giants Amazon and Google which have seen great success with their voice controlled smart speakers Echo and Home. The popularity of the smart thermostat Nest (acquired by Google in 2014) also gets a notable mention.

Home automation, IoT and Smart Home products are on the rise. Business Insider predicts that the number of IoT devices in use will have almost quadrupled from 2016 to 2021 (from 6.6 billion to 22.5 billion devices) and they forecast a total investment in IoT technology of \$4.8 trillion in the same five year period. So when designing a product for the home it is hard to ignore the possibilities of making it a part of the Smart Home ecosystem.

But the ever increasing digitalization of our everyday lives isn't without its drawbacks. A main concern is that of online security. Anything connected to the internet is in risk of being compromised through hacking. Although luckily a rat trap malfunctioning isn't a life and death situation (at least not for us humans) as it could potentially be in an autonomous vehicle or industrial equipment. But still as long as we keep



Smart speakers on the rise. Amazon Echo, Google Home and the Amazon Echo Dot in front

it in mind and adhere to best practices in terms of security.

Another concern is that when you rely on a service there is a risk that support for that service gets discontinued. An example of this is the Revolve Hub, a smart home hub which got acquired by Nest. They later shut down the servers supporting their system basically rendering the hardware useless.

Relating to my own product if for example we are forced to discontinue support for the app then it could potentially cripple the product in terms of interaction. But on the bright side it would still be a fully functional mechanical rat trap, just not as smart.



Pest control as part of the Smart Home ecosystem together with security cameras, weather stations, light fixtures and a host of other products.



## Hardware and radio protocols

If the product is to go into production we must consider how it communicates with your home network, more specifically which radio protocol to utilize. There are a number of different options that will also affect how compatible the product becomes. Around a decade ago transmitting data over Wi-Fi and Bluetooth required a lot of power and many devices which relied on batteries would get drained too fast. With smart home hubs such as SmartThings the use of other protocols became the answer such as Z-Wave and ZigBee because they utilise low energy radio waves and will save on battery life. Both of those protocols are still in use today but pretty much exclusively within home automation.

Today the power consumption problems with Wi-Fi has been solved. For example the Nest thermostat operates over Wi-Fi and both Amazon and Google have opted to not include any other protocols apart from Wi-Fi and Bluetooth in the Echo and Home smart speakers. Bluetooth also received an update with Bluetooth LE (low energy) meaning wearables such as Fitbit can sync to your phone throughout the day and still go a week in between charges.

So why should we consider using Z-wave hardware if Wi-Fi and Bluetooth are just as energy efficient? The answer to that question is range. Z-wave is still superior to standard Wi-Fi in terms of range. Bluetooth LE claims it has a similar range capabilities as Z-wave around 100m. But it since the product is meant for outdoors use and signals will potentially have to travel through concrete, wood and other building materials determining the best solution will require testing.

Another potential hurdle is if Z-wave turns out to be the optimal choice in terms of range then we are dependant on using a smart home hub to relay the signals between the trap and the app. If the users have to own a hub it will limit the potential market compared to if the trap can connect directly to a router which is found in almost every home these days.



An example of a Smart Home Hub: Samsung SmartThings Hub with Accessories

### SOURCES:

[https://en.wikipedia.org/wiki/Home\\_automation](https://en.wikipedia.org/wiki/Home_automation)

The Internet of Things Report – Business Insider

<https://www.theguardian.com/technology/2014/mar/20/internet-of-things-security-dangers>

<http://www.businessinsider.com/googles-nest-closing-smart-home-company-revolv-bricking-devices-2016-4?r=UK&IR=T&IR=T>

<https://www.cnet.com/news/the-only-way-to-save-the-smart-home-hub-is-to-kill-it/>

# WHO IS THE PRODUCT FOR?

For this project I started out thinking quite broad both in terms of which design field to delve into (interaction, service or product design) and also as to who I was designing for. So I tried mapping the different stakeholders to try and see the bigger picture. Who would be the potential end users and how do they relate to the other stakeholders?

If I were to create a product for the pest control technician I would need to consider how it fits into their ecosystem of services and products. And if the product were to be a part of a service then it could be a service provided by the pest control company or potentially the insurance company.

In the end after doing field research and looking at the traps currently on the market I felt there was great potential in designing a smart trap for the home market since there was a distinct lack of products that are both smart, made for outdoors use and aimed at the homeowners.

	Indoors	Outdoors
Professional user		
Private user / Home owner		

The product is aimed at the homeowner for outdoors use. But that is not to say that the product can't be used indoors and or by the professional exterminator as well.

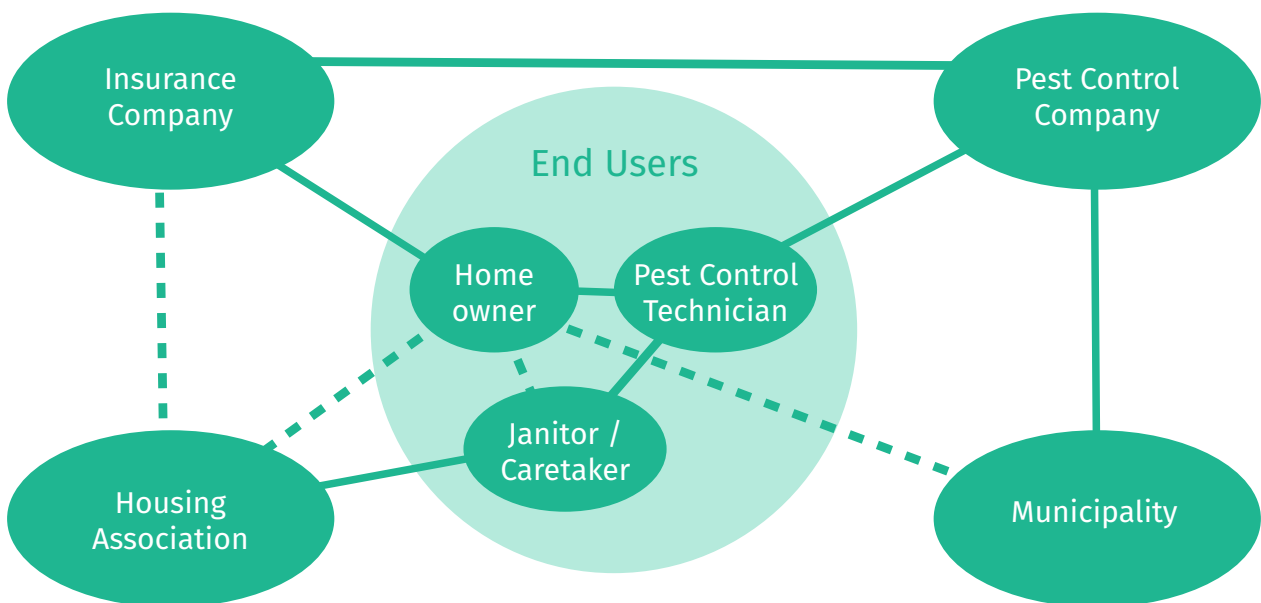

Mapping the different stakeholders with the potential end users in the middle

# DESIGN PROCESS

# ACCOUNTING FOR RAT BEHAVIOUR IN THE DESIGN

Rats can be tricky to get rid of once they have established themselves. They are much smarter than the common mouse and highly adaptable. Rats are also known for being neophobic, which means that they are inherently sceptical to changes in their environment or anything new, this poses a problem for anyone trying to exterminate them.

For instance if we introduce a new trap into the habitat of a rat we might not see initial success right away. The pest control technicians claim that they find the most success with the older traps that have been in use for a while. This includes if they move a used trap to a new location, they say it will perform better than a brand new one would. The dirtier the better. This has a lot to do with the smell, the old traps will smell of rat and that seems to reassure other rats. There has been some experimentation at Anticimex with sprinkling saw dust from the cage of domesticated rats in and around the traps. This of course is not a scientific study so we should not draw any conclusions from whether or not it leads to a better catch rate, but the technicians claim it works. Another theory regarding smell



## BROWN RAT (*RATTUS NORVEGICUS*)

- Weight: 200-500 grams
- Length without tail 18-25 cm
- Tail: 15-21 cm with dark upper side and light underside)
- Behavior: Shy, night-active and can show fear of new unknown food, new objects and strange smells in its environment.
- Features: Good to climb, swim and jump. They can jump 90 centimeters straight up, one meter horizontally and down from a height of 16 meters.
- Can fit in gaps as small as 1.2 cm in height due to a flexible rib cage.
- Lifetime: about one year, but longer under optimal conditions. Gets sexual mature after 2-3 months, and gets 8-12 pups (but sometimes 20) 4-7 times a year.

Source: FHI - <https://www.fhi.no/nettpub/skadedyrveilederen/gnagere/brunrotte/>

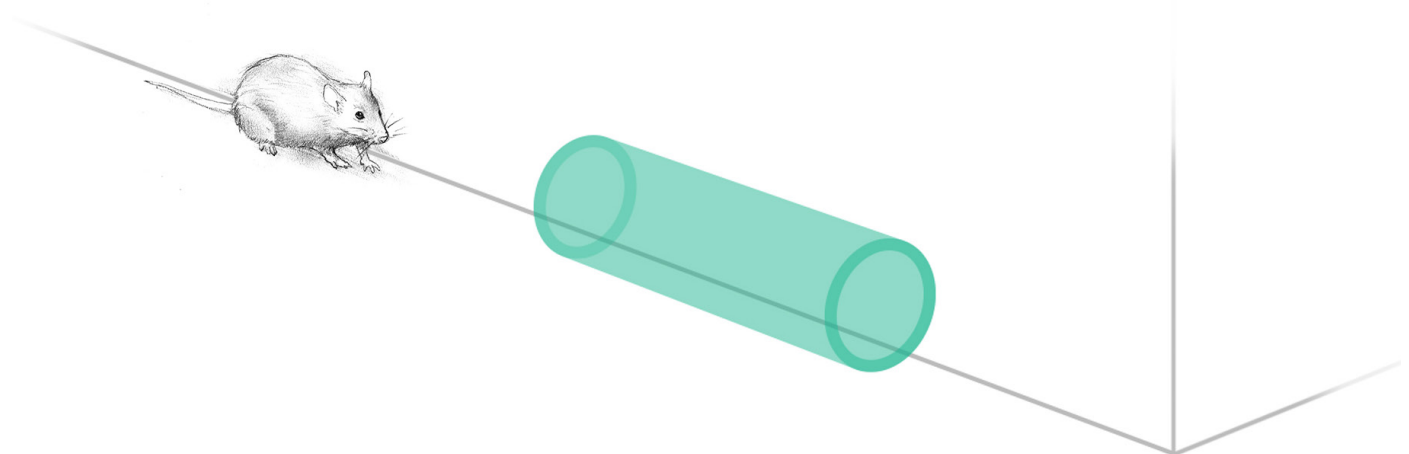

Ideally a rat trap should be positioned next to the wall since the rat has a fear of open spaces and will hug the wall to navigate. The opening should also be oriented so that the rat approaches it head on.

is that the new traps smell of fresh plastic and that might deter rats from approaching it.

I will take advantage of the rats keen sense of smell in my trap since it utilises bait. But making it smell less new or smell more of rat is a lot trickier to do on a large scale. So how can we convince the rat to trust our trap then? By looking at rat behaviour I hope to solve that in two ways.

1. Placement of the trap.
2. Layout of the trap.

Looking at the first point you want to place the trap along a wall where the rat have been spotted. This is because rats dislike open spaces and will often navigate by hugging a wall. So the opening of the trap should ideally be parallel to the wall. So I must design a trap that can easily be placed as flush as possible to a wall surface.

Regarding the second point I have chosen to design the trap which is shaped like a tunnel. The reason being that brown rats often make burrows and dig their own tunnels underground. Also since the rat will be able to see straight through the trap it will probably make it more inclined to enter as opposed to a trap with only one opening and exit. Lastly having a tunnel shape means that the trap will have two entrances so that the rat has access whichever way it approaches the trap.

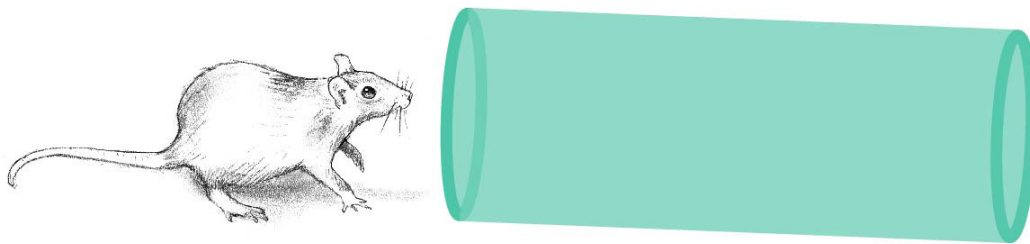

A rat might hesitate to enter a trap if it is perceived as a dead end. If we shape it like a tunnel the rat will probably feel more at ease and we will have greater success at luring the rat into the trap. The tunnel shape also means twice as many entrances.



# USER SCENARIOS

To get a better understanding over the user experience I mapped different user scenarios. Each scenario sparked a number of questions helping me see what I need to look closer at during the development.

## SETTING UP THE TRAP

### SET-UP

#### UNBOXING

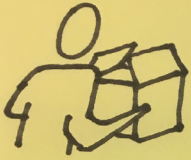

- WHAT IS INCLUDED?
  - TRAP
  - MASTER UNIT
  - WALL MOUNT
  - INSTRUCTIONS

### SET-UP

#### FINDING SUITABLE PLACEMENT



- SHOULD THERE BE AN INSTRUCTION BOOKLET?
- HOW DO YOU KNOW IT'S WITHIN RANGE OF CENTRAL UNIT / NETWORK

### SET-UP

#### PLACING THE TRAP / INSTALLATION

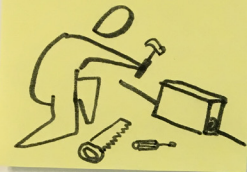

- DO YOU NEED WALL MOUNT / HOW TO DETERMINE?
- TOOL REQUIREMENTS

### SET-UP

#### PAIRING THE TRAP

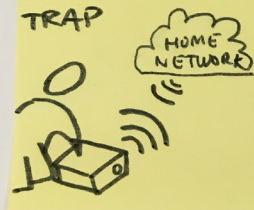

- PAIRING INSIDE BEFORE MOUNTING?
- QUICK PAIR OR OTHER METHOD?

# EVERYDAY USE

EVERYDAY USE

**BAITING THE TRAP**

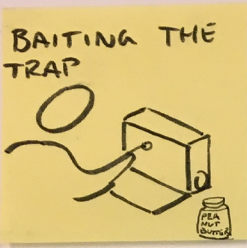

- BAIT TRAY
- EASY TO ACCESS
- EASY TO CLEAN

EVERYDAY USE

**ARMING THE TRAP**

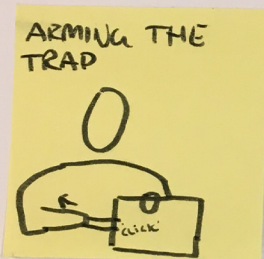

- HOW MUCH FORCE IS NEEDED
- TWO HANDED OPERATION ONE HANDED IF IT'S MOUNTED?
- HOW DOES THE TRAP SHOW HOW TO OPERATE IT? DESIGN SEMANTICS

EVERYDAY USE

**GETTING ALERTS FROM THE TRAP**

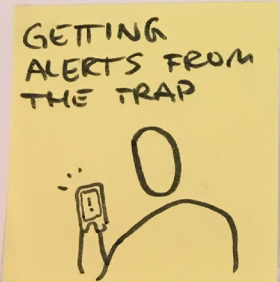

- ALERTS ON MOBILE ONLY OR ALSO ON MASTER UNIT
- TONE OF VOICE



EVERYDAY USE

**EMPTYING THE TRAP**

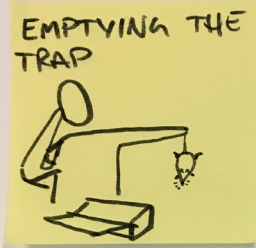

- DO YOU HAVE TO OPEN THE TRAP TO REMOVE RODENT?
- AS LITTLE PHYSICAL CONTACT AS POSSIBLE
- WILL IT FALL OUT IF YOU TILT THE TRAP?

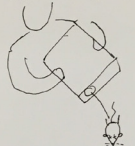

EVERYDAY USE

**RESETTING THE TRAP**



- SAME AS "ARMING"
- DO YOU NEED TO OPEN THE TRAP OR ONLY PULL THE LEVER?

# OCCASIONAL EVENTS

OCCASIONAL

**CHECKING STATUS**



OCCASIONAL

**MAINTENANCE & CLEANING**



- CHANGING BATTERY
- REPLACING COMPONENTS?
- SHOULD YOU CLEAN IT?

# LAYOUT OF THE TRAP

There were three major factors that played a role in shaping the layout of the trap.

1. The trap must ensure swift and humane extermination of the rat.
2. The trap should be easy to handle.
3. The trap should be safe to use, especially if you have curious pets and children around.

Looking at the first point as mentioned earlier about the humane extermination of rodents, if we are designing a mechanical trap it should provide a swift blow to the neck with sufficient force to cause instantaneous death of the rodent. So we need to make sure that the trap is correctly dimensioned so that it can provide enough force. In addition we need to make sure that it's consistent and only goes off when the rat is in the correct position exposing the neck. To ensure this we guide the rat into the right position by designing the trap like a tunnel and in the middle of the tunnel is the portion where the rat can poke its head up trying to get to the bait. Here I have taken inspiration from two traps by Wisecon, the I-Trap and and the SmartBox.

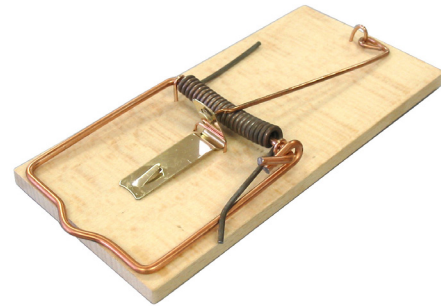

The classic wooden spring trap. It is cheap and often does the trick but it feels unsafe to handle and the open design means more cases of misfire causing a crippled rat instead of a dead one.



Mjölner rat trap. Compared to the classic trap this does a better job at guiding the rat into the correct position. The yellow hatch in the middle contains the bait. The rat will try to poke it open with its nose and springing the trap in doing so.

Electronics  
Battery & Antenna

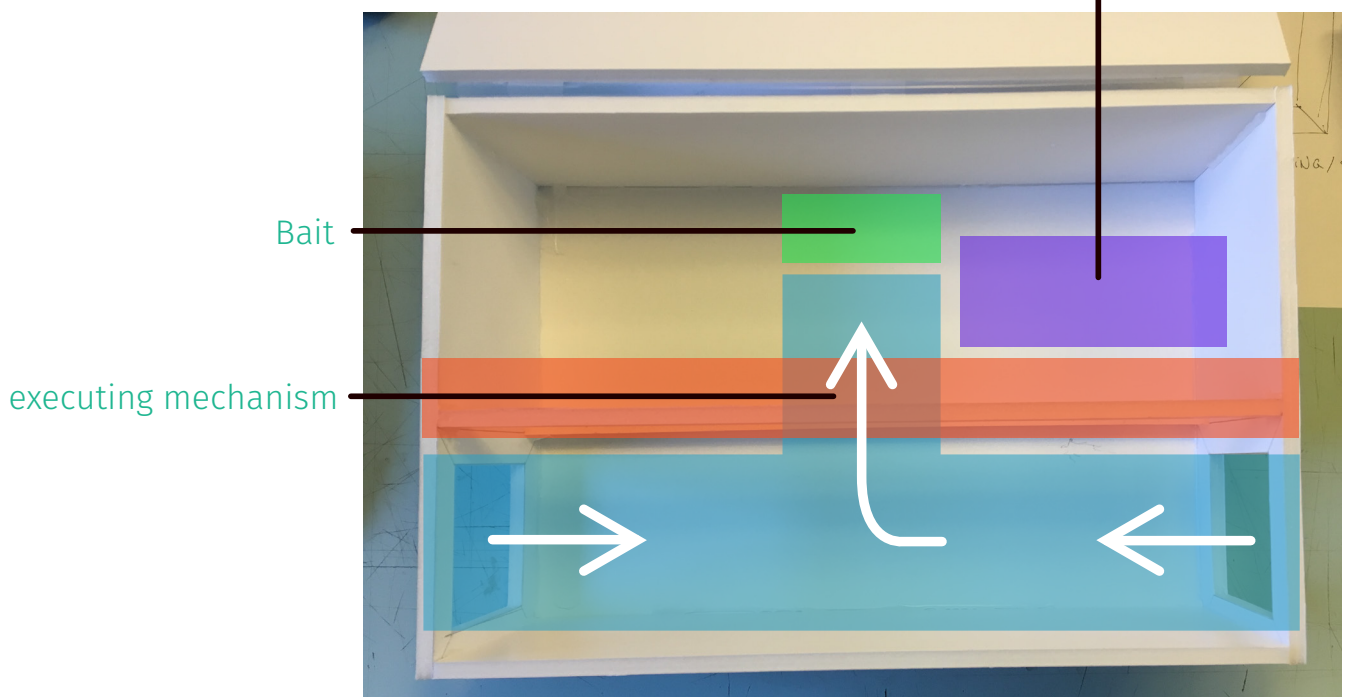

Basic schematics of the layout. The blue shows the t-shaped tunnel with two openings and the bait enclosed in the middle. The trap springs when the rat pokes its head up towards the bait.



Regarding handling of the trap we want a certain size so that when we hold and operate the trap we don't have to touch in the places that have been in contact with the rats. At the same time it shouldn't be too bulky so that it is hard to handle and move around.

About the safety of the trap it's important that when handling the trap you should never feel that it's unsafe, like it might suddenly snap shut on your finger (like the traditional wooden spring trap). Equally important we need to consider the more inquisitive of us, children and pets. Here the t-shaped tunnel helps prevent easy access to the mechanical parts. As an additional fail safe the trap won't fire when the front cover is open.



The Wisecon I-Trap. This trap utilises the same t-shaped layout, although with an open lower half instead of a tunnel.



The backside of the Wisecon I-trap. Here we can see a small tube which has bait at the top. The rat will poke its head in from below getting hit in the neck by the red spring loaded swing arm.

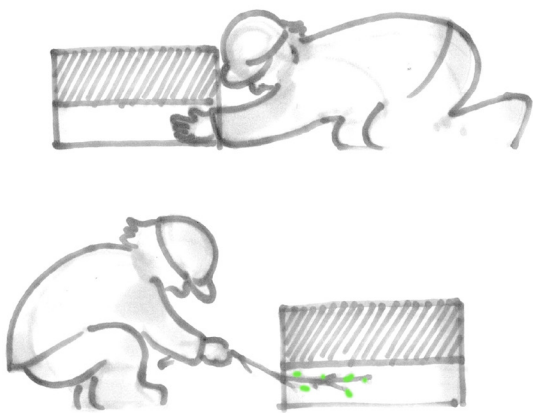

It is important that the layout of the trap prevents children and pets from accidentally triggering it and getting hurt.



Similar to the Wisecon SmartBox trap I have opted to go for a tunnel through the lower portion of the trap that runs parallel to the wall.

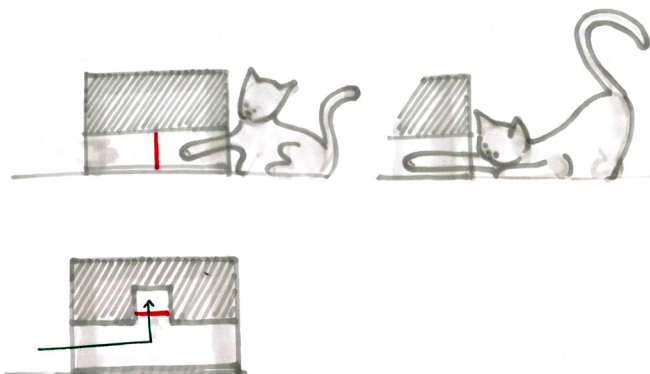

# FOAMCORE MODELS

I created a couple of foamcore models at an early stage after I completed the research phase. They are rough and simple models to get a feel for the possible size and shape of the final product.

They also proved useful when discussing the project with supervisors and external people since you had a physical reference you could hold in your hand or place next to a wall.

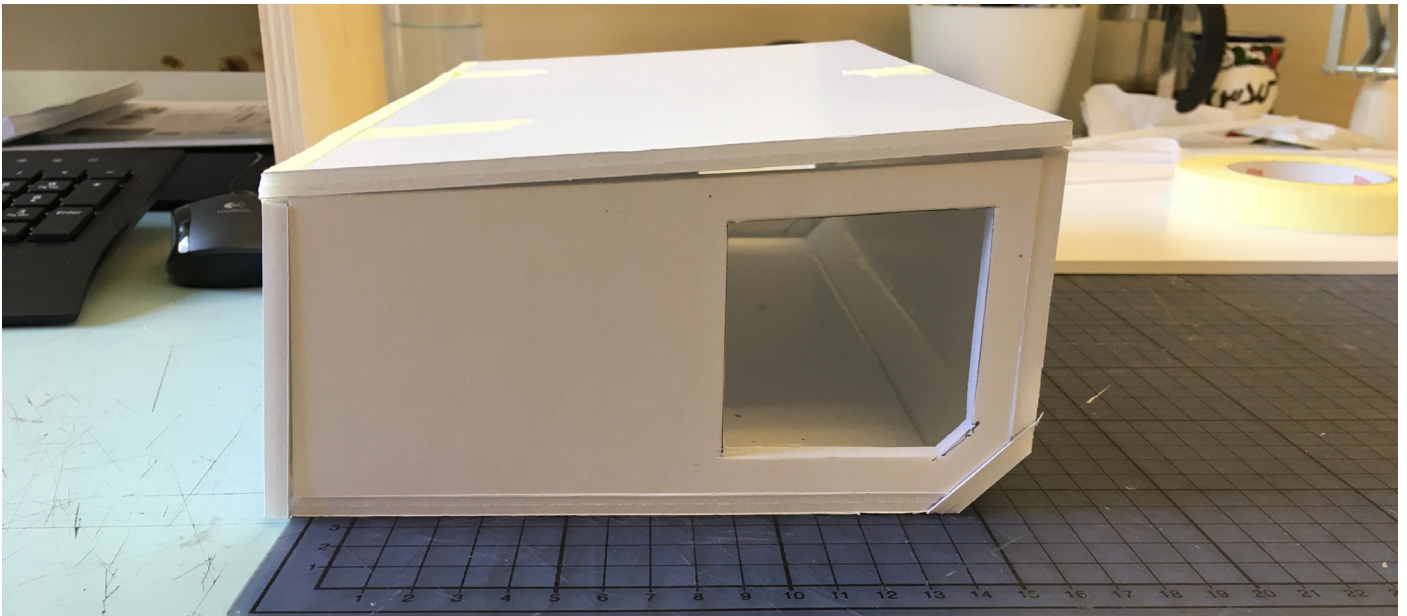
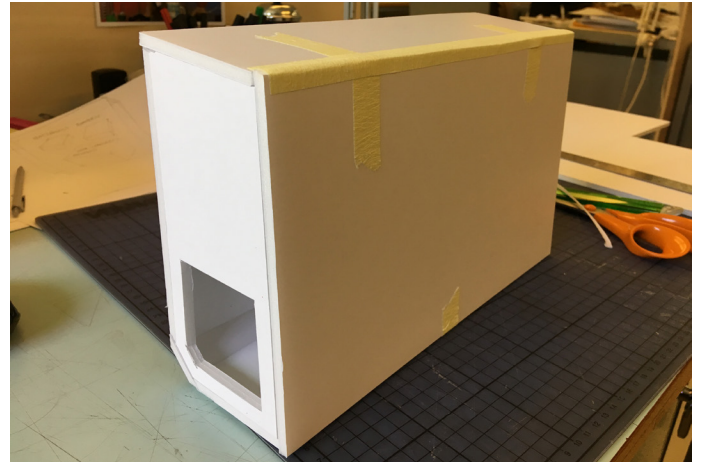



# MECHANICAL MODEL

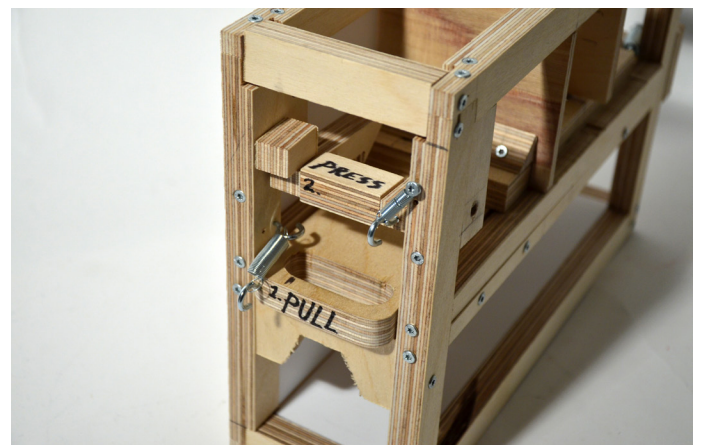
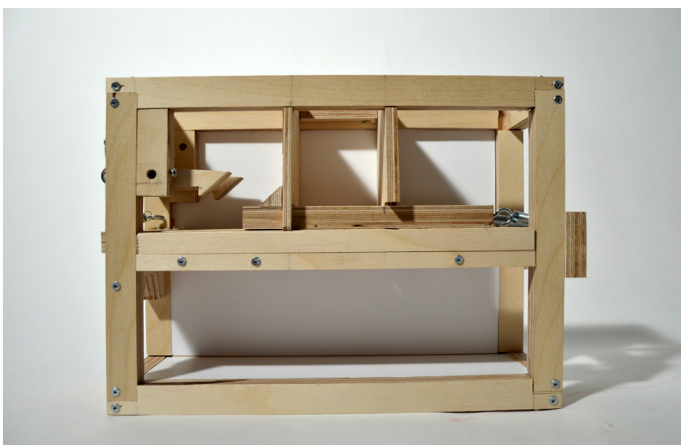
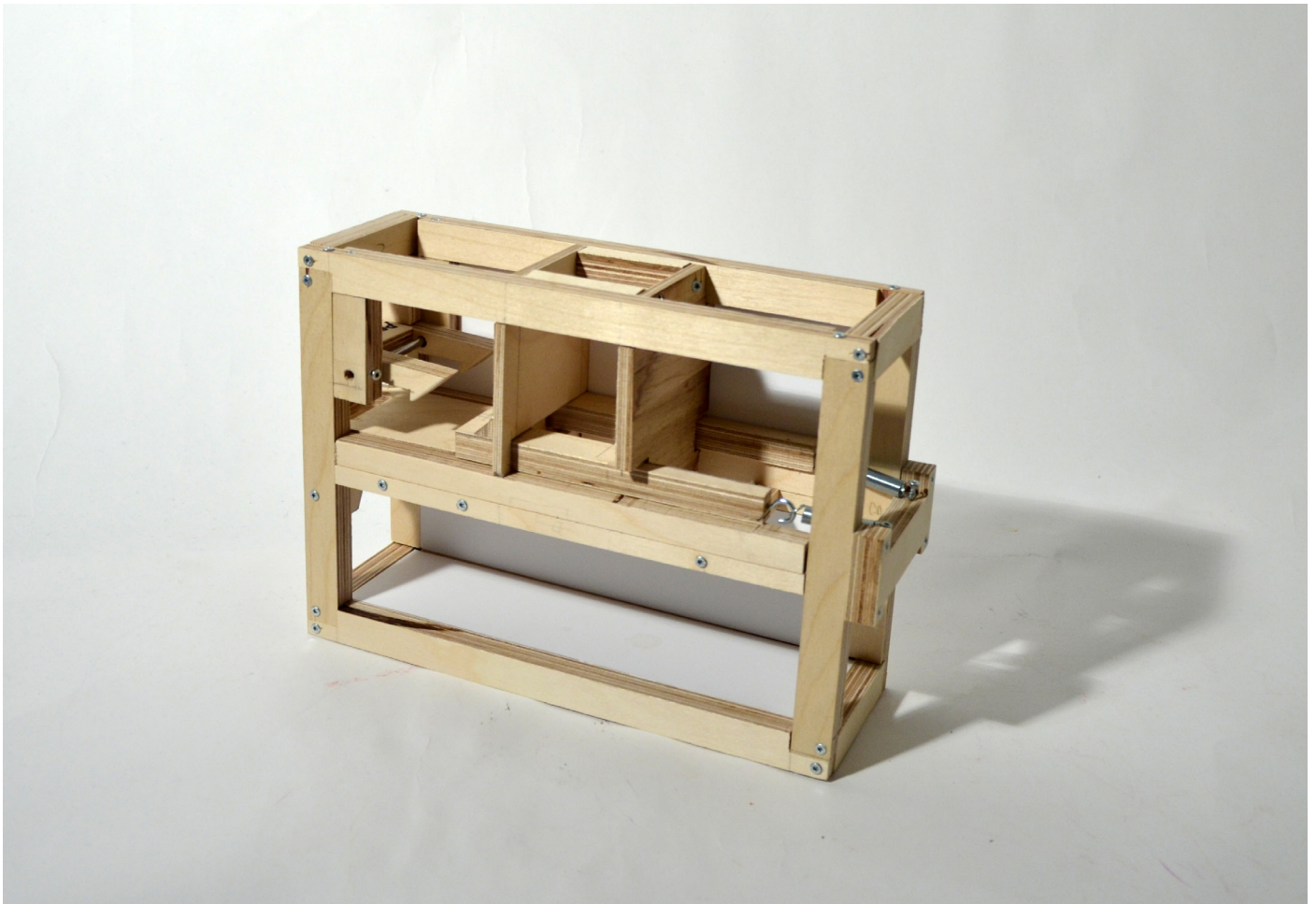

The mechanical model is a bit overengineered and bulky compared to the final product but it works well as proof of concept. It is made out of plywood, foamcore and a whole lot of screws.

To use it you pull back the handle until the bar locks in place and to activate you press down on the hooks.

The operation of pulling the handle to set the trap is similar to how it will work in the final product. But since the model lacks any of the electronics, triggering the trap is done manually.

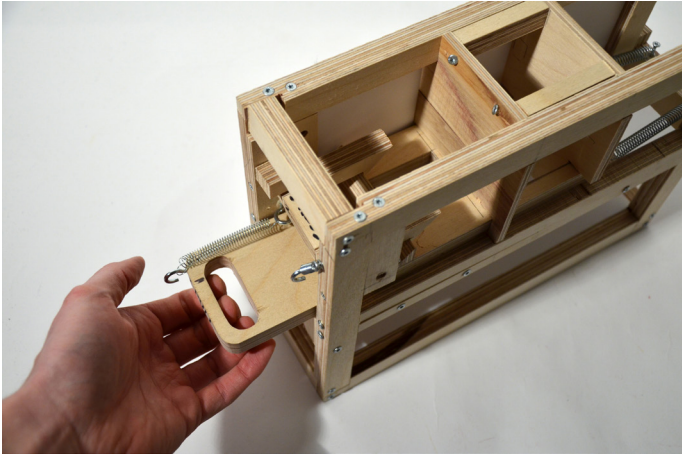

Pulling the handle to set the trap.

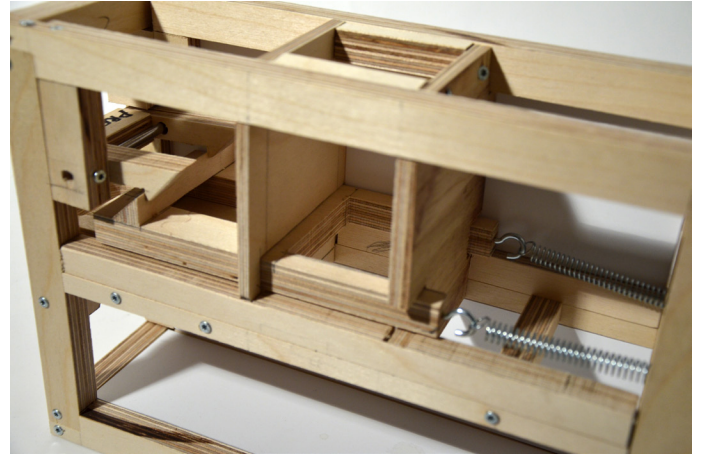

To the right we can see the springs which pulls the bar shut. They are attached in the opposite end from the handle.



Not armed.

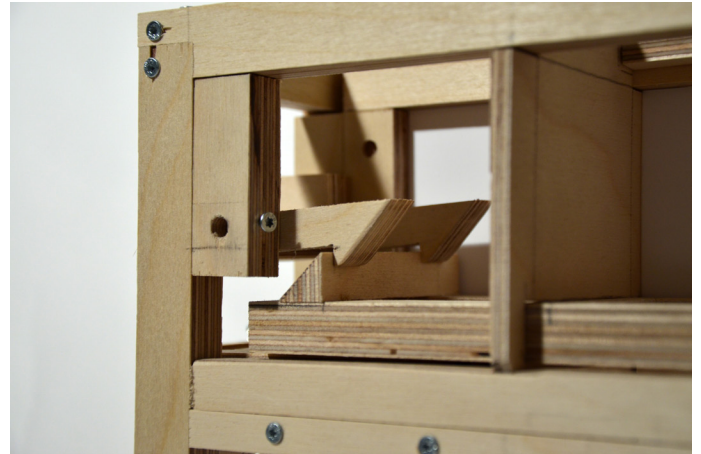

Armed.



# HANDLING OF THE TRAP

Handling the trap was important to look at. Especially the part that revolves around removing a dead animal. How do we ensure that we don't have to touch the trap in the same places that the rat has touched. And can we empty the trap without having to lift out the dead rat?

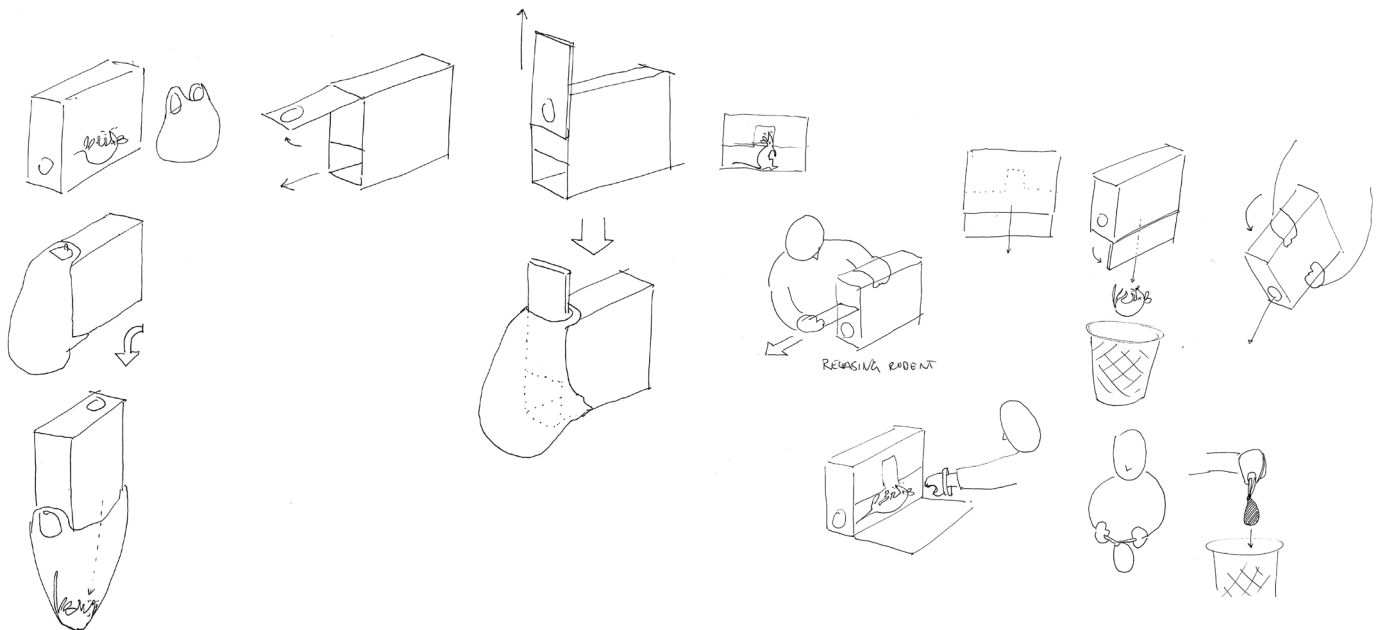



# SKETCHES

Below are some of the sketches from the project looking at both form and function.

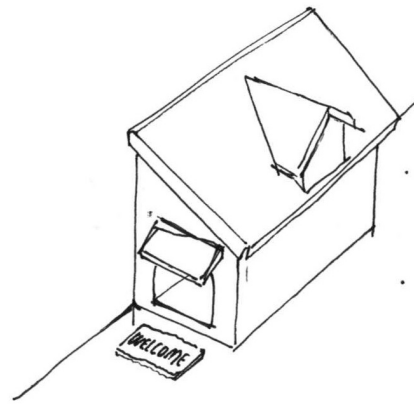

## EXPLORING SHAPES

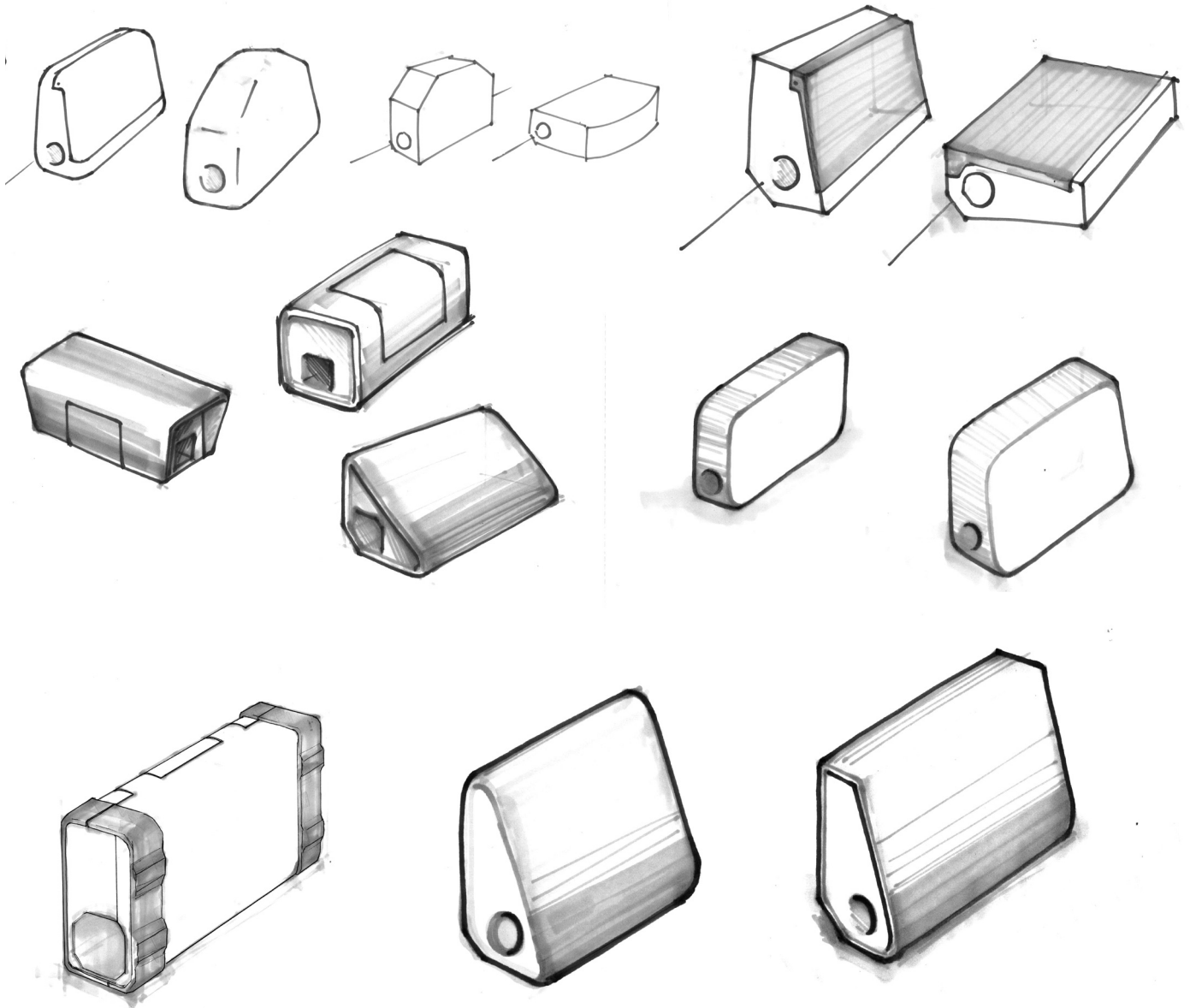

## LOOKING AT WAYS TO OPEN THE TRAP

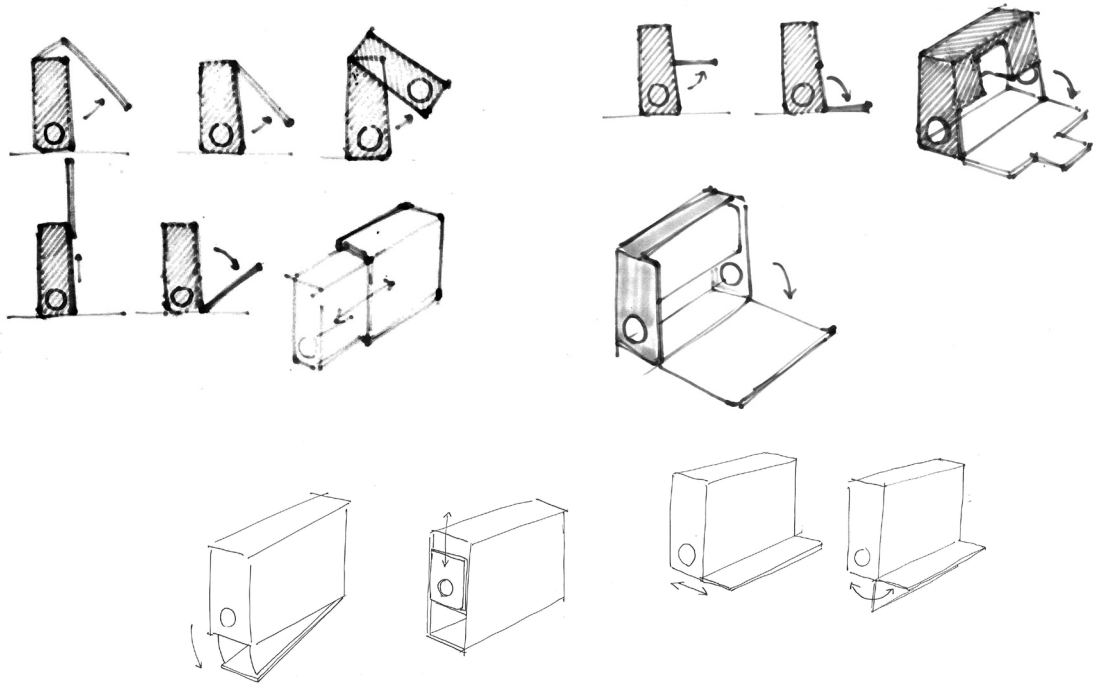

## POSSIBLE HANDLE FOR TRANSPORTATION

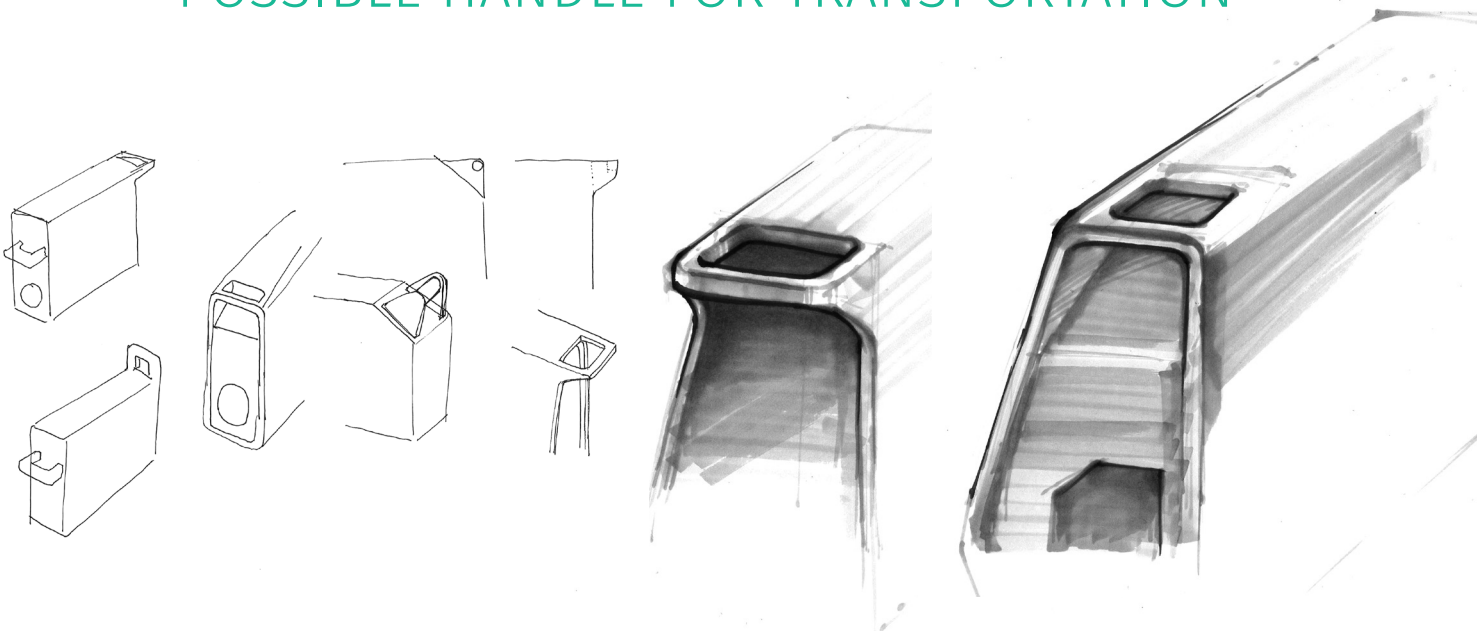

## USING THE ACTIVATING HANDLE AS AN INDICATOR

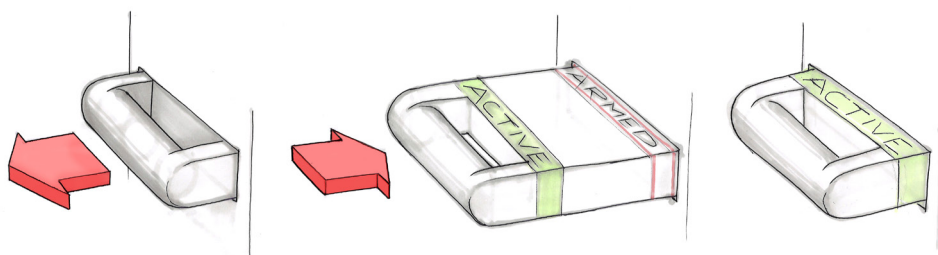

## EARLY CONCEPT

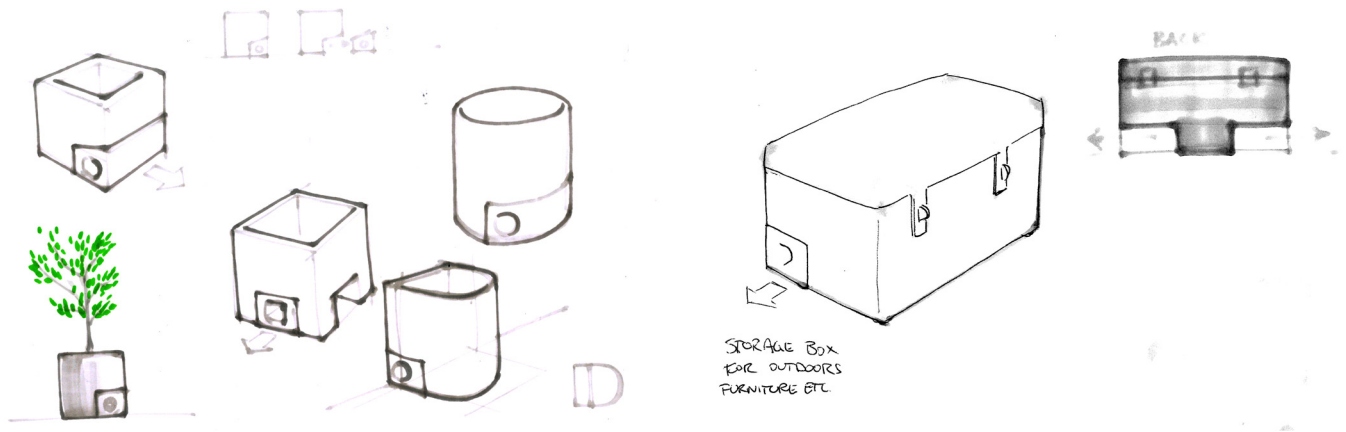

Early in the project there emerged a concept that was about concealing and camouflaging the trap in different objects such as an outdoors planter or an outdoors storage box. This concept had potential for a user desiring a more discreet trap.

But in the end I decided to focus on designing a more aesthetically pleasing trap so that perhaps the user wouldn't see the need for hiding the trap away.

## CONCEPT SKETCHES

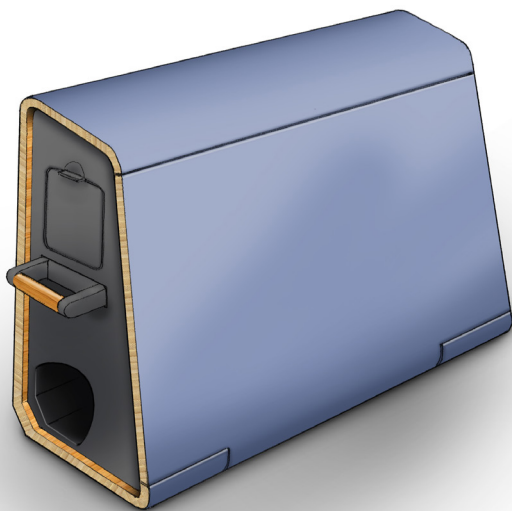

These concept drawing are quite close to what I ended up with in the end. Although at the time I was considering creating a core out of ABS and the outer shell in laminated wood.

ABS plastic in both the core as well as in the outer shell.

However since plastic will be more reliable and perhaps last longer outdoors I decided on using



# MODEL WORK

The model was created by CNC milling the main body out of brown model foam. Two end pieces were SLS printed along with the front cover. The end pieces were attached to the sides of the brown foam core.

I printed the smaller components in PLA plastic on a Ultimaker 3D printer. This proved useful since I could make corrections to parts as I went along. Like for example the handle which needed adjustments to the hole for the fingers.

1:1 MODEL

MATERIALS

BROWN MODEL FOAM

PLA PLASTICS

NYLON (SLS)

STEEL RODS

SPRAY PUTTY

WOOD FILLER

SPRAY PAINT

PLASTI DIP

## 3D PRINTING

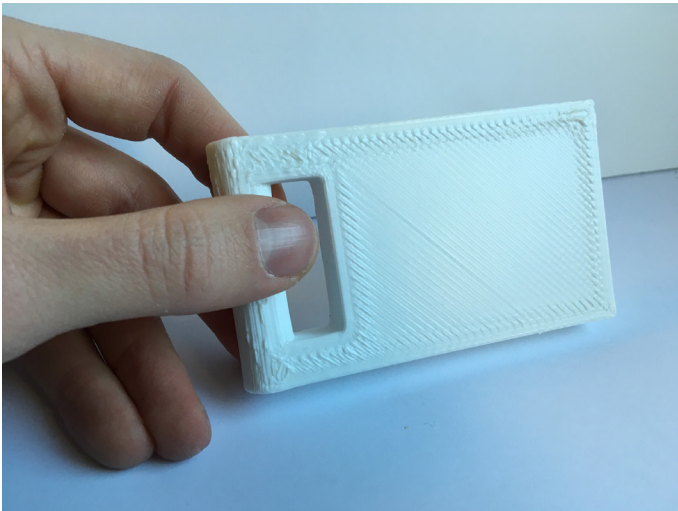

Rapid prototyping. I discovered that the lever needed adjustments and the part was printed again after making corrections in solidworks

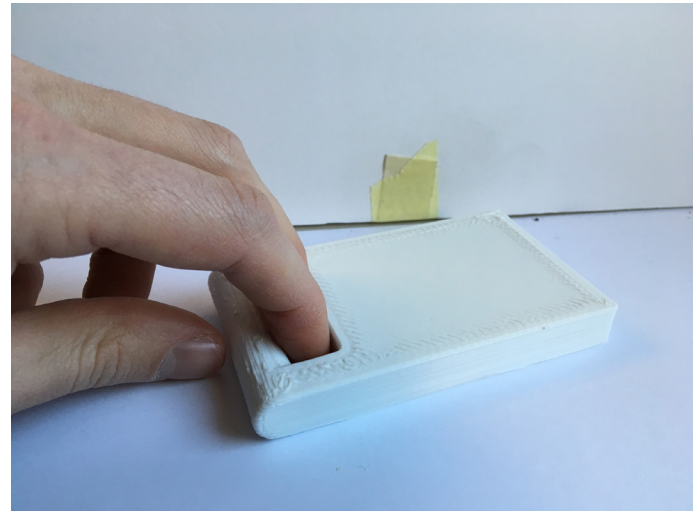

Bad fit. Hole needs to be bigger, especially if the user is wearing gloves.

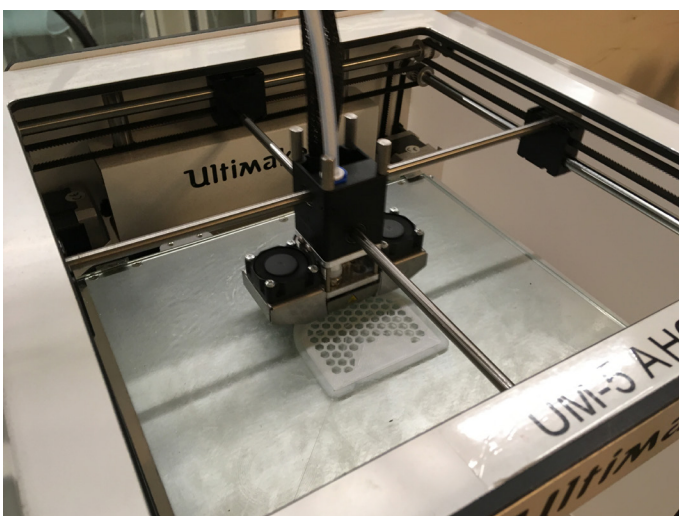

3D printing the bait drawer on the Ultimaker.

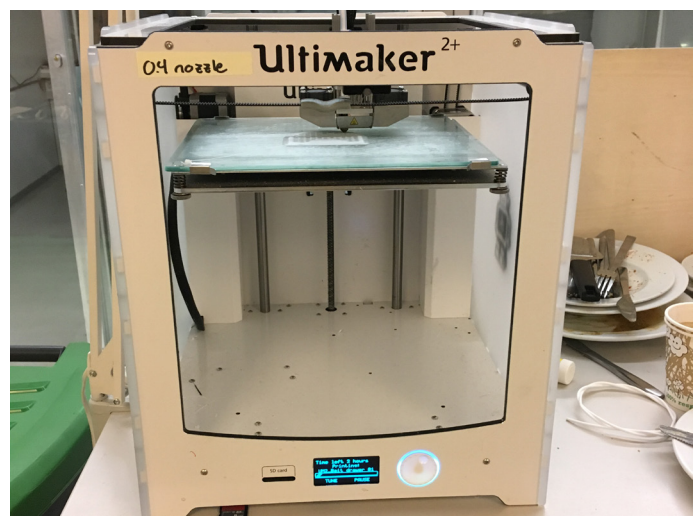



# WORKSHOP

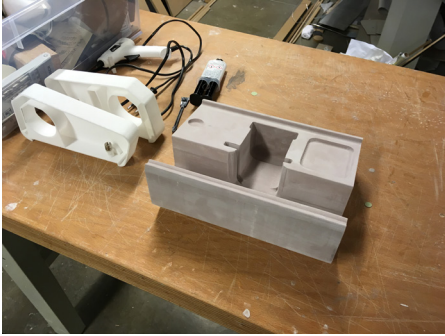

The model in various stages of assembly.

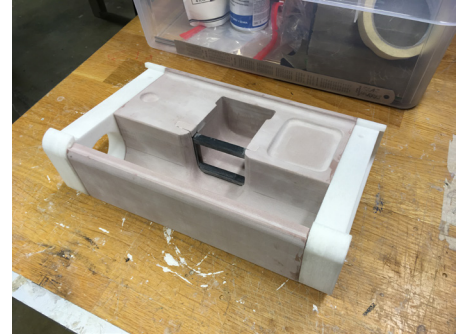

Fitting the front cover onto the rest of the model.



Masking of the model before applying the second color.

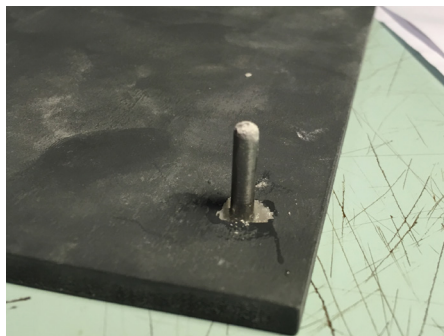

Steel pegs where attached to the front cover. These will lock into place by magnets inside the end peices.

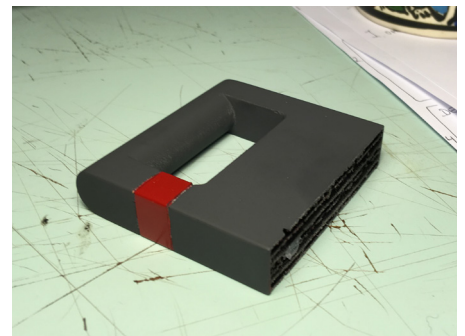

The handle painted and cut to size.



Smaller parts getting a coat of paint.



All parts ready for assembly



# FINAL PROPOSAL

# 3D MODEL

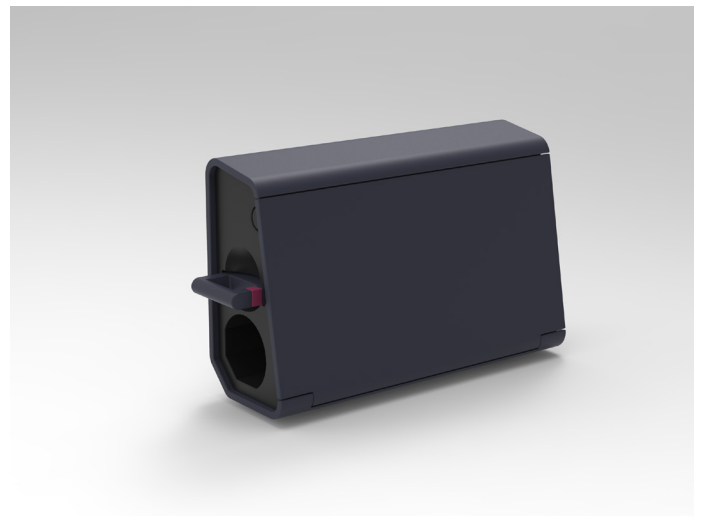
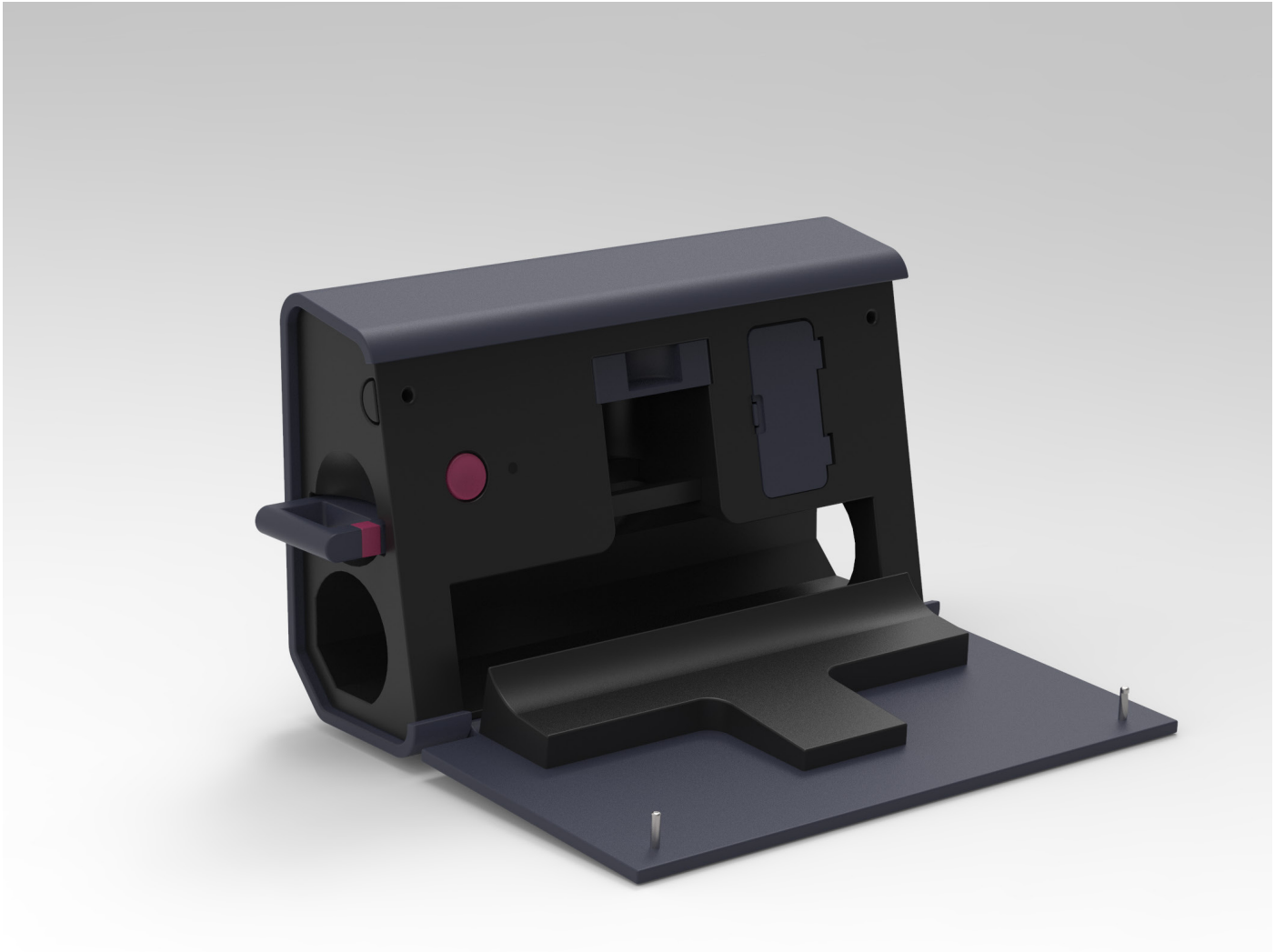

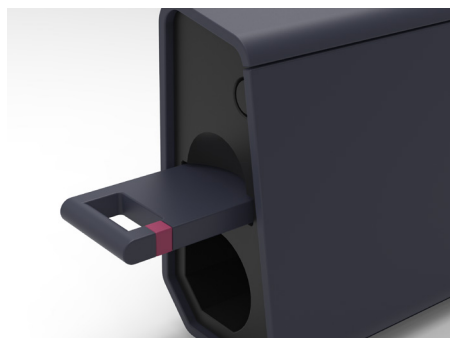
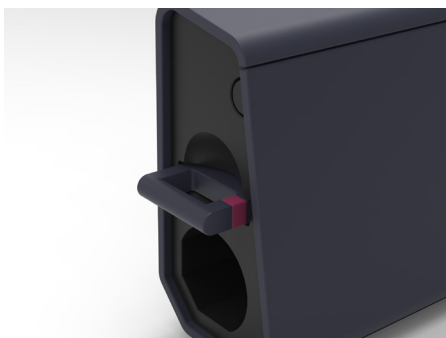
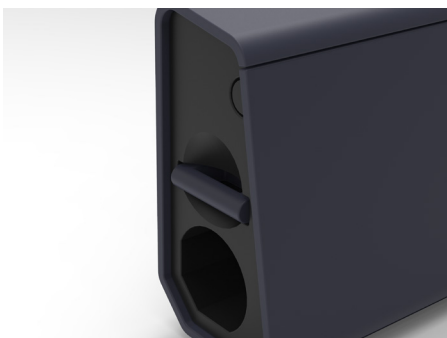
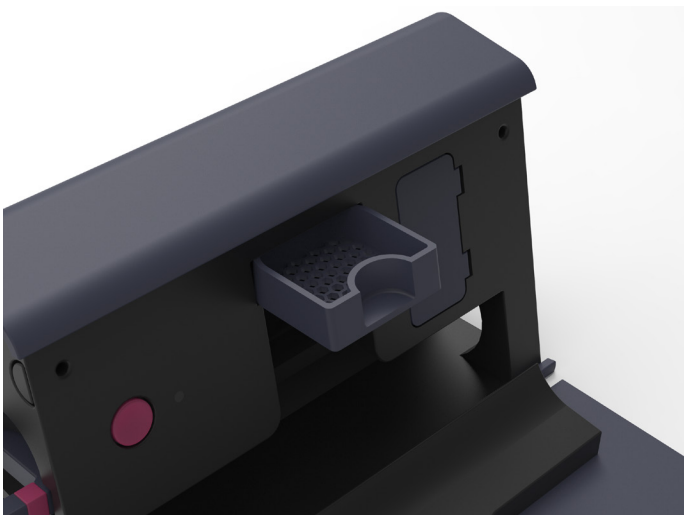
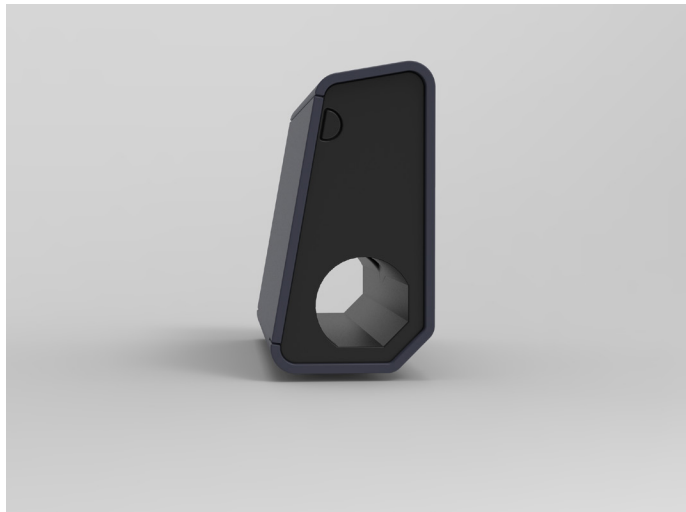
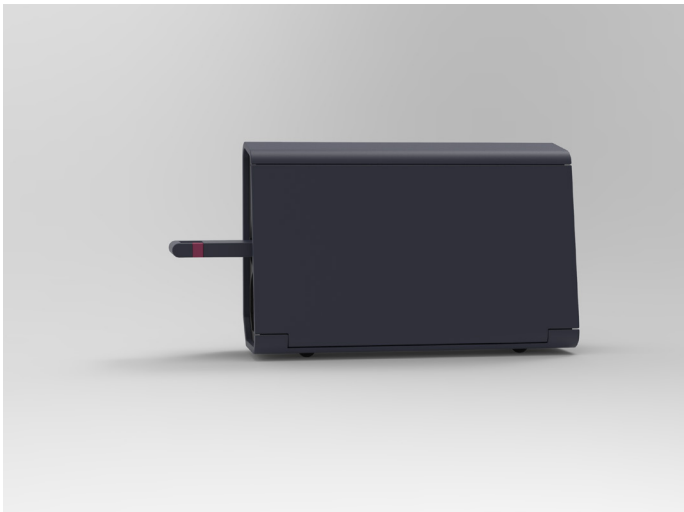



# 1:1 MODEL



# MATERIALS AND PRODUCTION

The case for the trap will be mostly produced through injection moulding.

Since the trap is for outdoors use it needs to be produced in materials that can withstand wind, rain, sunlight and changes in temperature. Therefore I have chosen ABS plastic which is already utilised in a wide range of products that is used outdoors.

For the model and renders I have chosen a neutral colour that perhaps will fit in with most households. But I think it would be a good idea to offer the trap in a wide variety of colours so that you for example can find a colour that matches your house.



# SPRINGING THE TRAP

The illustration shows how the tunnel with the t-shape will guide the rat into the correct position so we can assure humane killing.

1

Rat enters trap through one of the two entrances

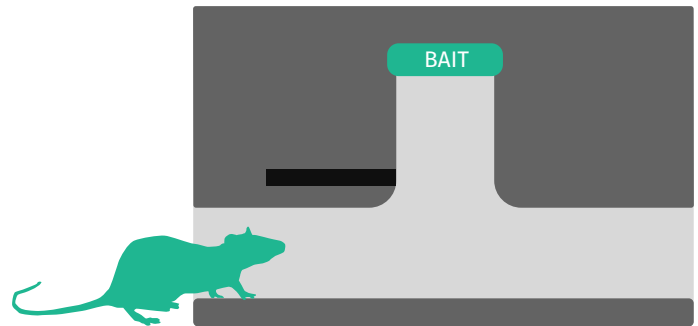

2

As it reaches towards the bait it trips the sensors

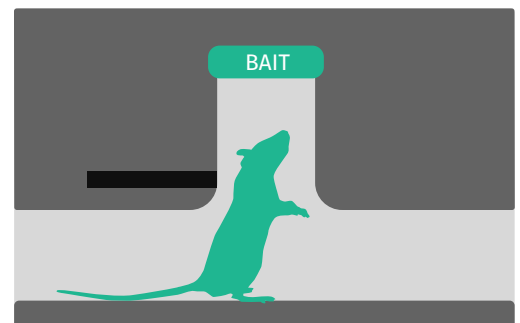

3

The rat receives a swift killing blow to the neck

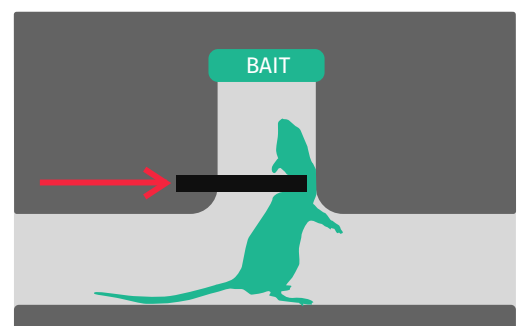

# THE TRAP IN USE

I created a set of illustrations showing how to set up and operate the trap. They could be part of an instruction manual.

## SETTING UP A NEW TRAP

1

Open the front cover by pressing the two side buttons

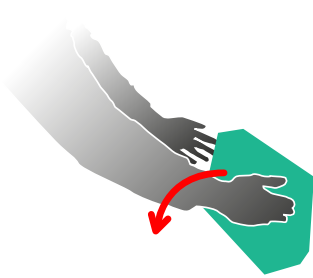

2

Open the battery hatch and insert new batteries

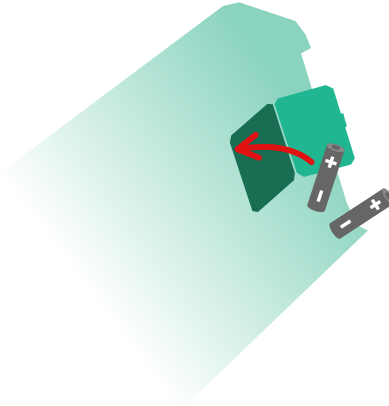

3

Press and hold the pairing button until the light starts to flash. The trap is now ready to connect.

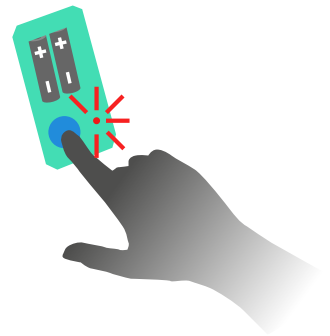

4

Pair trap with your router or Smart Home hub



5

The trap is now available in the app and is ready for baiting





# BAITING THE TRAP

1

Open the front cover by pressing the two side buttons

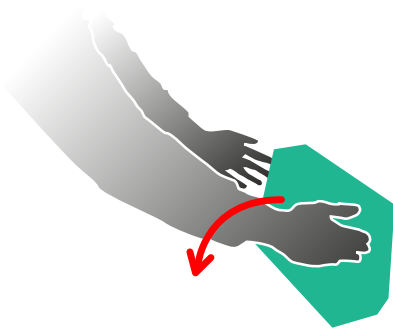

2

Slide out the bait drawer located at the top of the trap

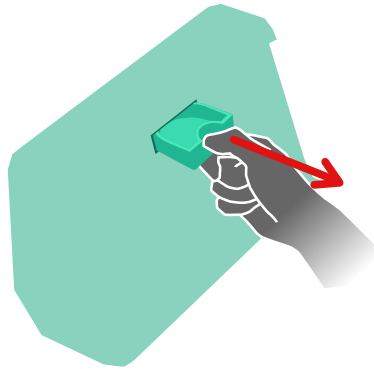

3

Add a bait pellet or a glob of peanut butter and replace the drawer

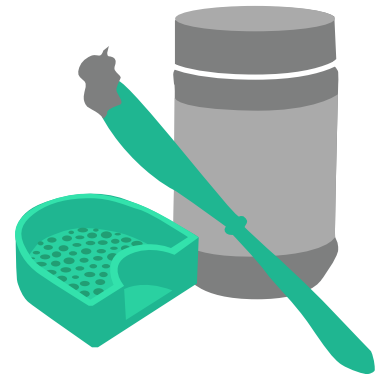

# ARMING THE TRAP

1

Open the front cover by pressing the two side buttons

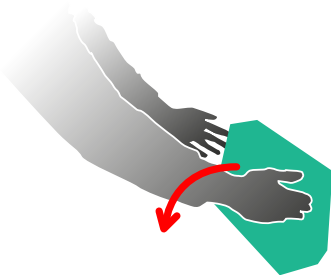

2

Make sure that nothing is obstructing the sensors

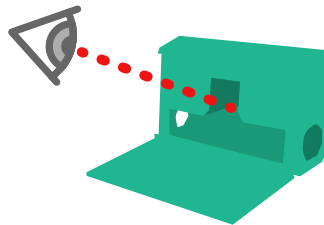

3

Press the reset switch to put the trap in active mode

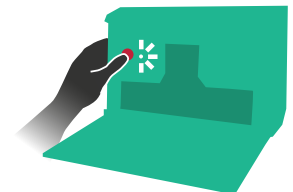

4

Close the front cover

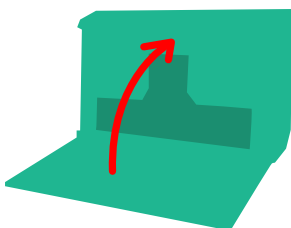

5

Pull back the lever until you hear it lock in place

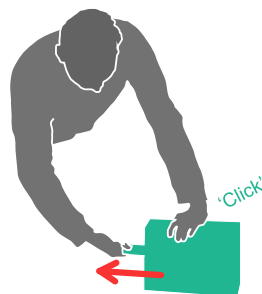

6

Trap is listed as active in the app



# EMPTYING THE TRAP

1

Pull back lever until you hear it lock in place

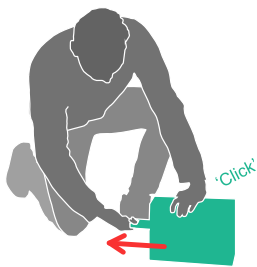

2

Lift up trap and move it over to a trash can

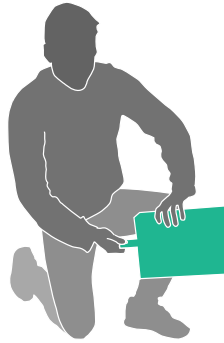

3

Tilt 90 degrees to empty the trap



# APPENDIX

# FURTHER DEVELOPMENT

For further development on this project I would really like to tackle the interaction. Designing the app and a user interface from simple wireframes to the whole UX. In addition I could go more into detail as how to solve the technical challenges when connecting the trap to the a smart home or home network.

I would also perform more user testing which I think would give me valuable insight. Both testing with homeowners that have had problems with rodents and together with professionals. The pest control technicians which encounter pests everyday sit on a vast amount of practical knowledge and I don't think further development of the product would be as good without the evolvment of them.

In addition I would try to develop a prototype, that incorporates both the mechanical parts with the electronics.

I was considering using wood for the casing of the trap but since plastic will hold up better against the elements I put that idea to the side. But I think it would be fun experimenting a bit with different materials to give the trap different expressions. In addition it could be that the rats prefer some materials over others.



# REFLECTIONS ON THE PROJECT

In this project I feel like there was no clear transition between the research phase and the design work. Instead the two phases were overlapping and I found myself going back and forth between the research and the shaping of the trap.

As written in the further developments there was a lot of things that I wish I could have delved into deeper but in the end I am glad that I choose to develop a product. Since I have been mostly studying interaction design during my master this has been a challenge and a great learning experience.

The product in itself I feel have a lot potential since it fills a gap in the market. And one could also develop it further. for example how would the product look and function if it was designed for the professional market, how would it look if it was only for indoor use or for a industrial setting? etc. Also it could potentially be a part of a larger system or service involving the insurance companies.

# REFERENCES & SOURCES

## BOOKS AND STUDIES

**Veien til godkjent skadedyrbekjemper** del 1 og 2, Published by Folkehelseinstituttet

Engeland S, Kjæstad HP, Grøndahl AM, Karlsson AC, Mejdell CM. **Dyrevernmessige konsekvenser ved bekjempelse av rotter og mus**. Veterinærinstituttets rapportserie 12-2010. Oslo: Veterinærinstituttet; 2010.

Broom DM, **The welfare of vertebrate pests in relation to their management**. In Advances in Vertebrate Pest management, ed. by Cowan DP and Feare CJ. Filander Verlag, Fürth, Germany, pp.302-329 (1999).

Katherine H. Langford, mfl: **The occurrence of second generation anticoagulant rodenticides in non-target raptor species in Norway**, Science of The Total Environment, Volumes 450–451, 15 April 2013

Thomas m.fl.: **Second generation anticoagulant rodenticides in predatory birds: Probabilistic characterisation of toxic liver concentrations and implications for predatory bird populations in Canada**, Environment International 2011, 37: 914-920.

Christensen TK, Lassen P, Elmeros M. **High exposure rates of anticoagulant rodenticides in predatory bird species in intensively managed landscapes in Denmark**. Arch Environ Contam Toxicol (2012) 63: 437.

Sharon A. Poessel, mfl: **Anticoagulant Rodenticide Exposure and Toxicosis in Coyotes (Canis latrans) in the Denver Metropolitan Area**, Journal of Wildlife Diseases, januar 2015

The Internet of Things Report – Business Insider

## ONLINE SOURCES

**Så farlig er musegift for andre dyr** - <https://forskning.no/husdyr-miljogifter-rovdyr/2016/11/musegift-farligere-enn-tidligere-antatt>

**Rottegift tar knekken på rovfugl** - <https://forskning.no/dyresykdommer-forurensning-fugler-okologi/2012/05/rottegift-tar-knekken-pa-rovfugl>

**Brown rat info** - <https://www.fhi.no/nettpub/skadedyrveilederen/gnagere/brunrotte/>

**Common house mouse** - info- <https://www.fhi.no/nettpub/skadedyrveilederen/gnagere/husmus/>

[https://en.wikipedia.org/wiki/Home\\_automation](https://en.wikipedia.org/wiki/Home_automation)

<https://www.theguardian.com/technology/2014/mar/20/internet-of-things-security-dangers>

<https://www.cnet.com/news/the-only-way-to-save-the-smart-home-hub-is-to-kill-it/>

<http://www.businessinsider.com/googles-nest-closing-smart-home-company-revolv-bricking-devices-2016-4?r=UK&IR=T&IR=T>

## OTHER

**Salg og bruk av muse- og rottegift** - Miljødirektoratet, faktaark M-619, 2016

Forskrift om skadedyrbekjempelse - <https://lovdata.no/dokument/SF/forskrift/2000-12-21-1406>

TO THE PEOPLE AT ANTICIMEX OSLO  
TO MY PATIENT SUPERVISORS NIC & MOSSE  
TO THE GANG THAT I SHARED THE DIPLOMA ROOM WITH  
A BIG

**THANK YOU!**