



# WHISPER

**PRESERVATION AND PROMOTION  
OF TRADITIONAL CRAFTSMANSHIP  
IN LINHAI**

XIA LI  
INTERACTION DESIGN DIPLOMA  
2017 AUTUMN

“记忆，应该是有一套算法的

和年龄有关，和所处的空间有关  
和每个人的认知和选择有关

它来源于文字、实物  
来源于口口相传。”

*A MEMORY ;  
A SET OF ALGORITHMS*

*RELATING TO THE TIME  
AND SPACE IN WHICH IT OCCURRED.  
IT ALSO RELATES TO PEOPLE'S COGNITION  
AND CHOICES.*

*IT IS CREATED FROM WORDS, PHYSICAL OBJECTS,  
AS WELL AS BEING HANDED DOWN BY  
WORD OF MOUTH.*

## Abstract

The rapid urbanisation has led to a gradual transformation of an “internationalised” style of living in Linhai. Traditional handicraft products are fading away from people’s daily lives, and young generation in the community seems to have lost many of those cultural memories.

The aim of this project has been to preserve and promote the local traditional craftsmanship via helping young people to build a closer relationship with traditional craftsmanship.

This project I have named WHISPER and it appears an exhibit. The whole structure of the exhibit attempts to bring young people a sense of heartwarming experience, evoke their memories of handicraft products and improve their appreciation of traditional craftsmanships.

The word-of-mouth has been the keyword in this project.

# Table of content:

<b>00 EXUCURATIVE SUMMARY</b>	<b>08</b>
<b>01 INTRUDUCTION</b>	<b>11</b>
CURRENT ISSUE	12
RELEVANCE	13
BACKGROUND	14
DESIGN CHALLENGE	17
<b>02 RESEARCH</b>	<b>19</b>
CASE STUDY	21
DESK RESEARCH	22
USER INTERVIEW	26
BRIEF	31
<b>03 CONCEPT AND PROTOTYPE</b>	<b>33</b>
INSPIRATIONS	34
SKETCH AND SCALED MODEL	36
CONCEPT DEVELOPMENT	40
CONCEPT OF THE AUDIO DEVICE	46
SIMULATION	52
<b>04 IMPLEMENT AND FEEDBACK</b>	<b>55</b>
OVERVIEW	56
AUDIO DEVICE PRODUCTION	58
STORY RECORDING AND EDITING	64
RESULT	66
FEEDBACK AND IMPACT	72
DESIGN POSSIBILITY	76
REFLECTION	78
<b>05 REFERANCE</b>	<b>80</b>

# Executive Summary

## CONTEXT AND GOAL

Nowadays, traditional handicraft products are fading away from people's daily lives. Traditional craft productions are declining or substituted by the mass productions, the young generation in Linhai have forgotten many of these traditional crafts.

The purpose of the project is to give young people a new kind of visiting experience and encourage them to dig out more beauty of traditional craftmanships.

## MOTIVATION

My partner MAY studio has a lot of similar events related to culture promotion, so I got help from them and learned from their previous projects.

In December, an exhibition called LOCAL CULTURE will be open in Linhai, this exhibition will last for three months. My project will participate in this exhibition and hopefully be able to make some positive influence on the topic cultural preservation.

## PROCESS & METHODS

The research process mainly focus on three parts: analysing and learning from existing cases; Desk research of bamboo craft, which was the selected craftsmanship for this project; Qualitative user interviews with young and senior citizens.

Based on findings of the researches, a concept of exhibit experience was developed. The process adopted Interaction design methods through the whole user journey.

## DESIGN PROPOSAL

Application of word-of-mouth was regarded as a core value of the whole structure of this bamboo craft exhibit. By collecting stories told by the local senior citizen, visitors can get knowledge of these bamboo articles as well as get to know how people use them in the old days.

## RESULT AND IMPACT

As a result, this exhibit called WHISPER was simulated implement. It will implement as a part of the exhibition LOCAL CULTURE at the local museum on the 26th December. I'm glad to have a simulation exhibit before the opening day, because then I can continue having some slight changes after getting feedbacks from visitors, One possibility after this project could be a website which is used to collect stories from local citizens.



# CHAPTER 01

## INTRODUCTION

01 INTRUCTION	11
CURRENT ISSUE	12
RELEVANCE	13
BACKGROUND	14
DESIGN CHALLENGE	17

# Current issue

THE DECLINE IS NOT ONLY THE CRAFTSMANSHIP,  
BUT ALSO THE MEMORIES OF THE LAST GENERATION.



## DEFINITION OF CRAFTSMANSHIP

A craftsmanship is a pastime or a profession that requires particular skills and knowledge of skilled work.

---- wikipedia

## TRADITIONAL CRAFTSMANSHIP IS FADING AWAY

As we all know the globalisation is a big issue all around the world, 30 years of rapid urbanisation in China has led to the gradual transformation of an 'internationalised' style of living in China and numerous traditional production techniques – such as textiles, ceramics, wood, bamboo craft and stone carving are declining or being substituted by mass production [1].

The young generation in the community seems to lose many of the cultural memory.



INTERNATIONLISE



[https://encrypted-tbn0.gstatic.com/images?q=tbn:ANd9GcTfYxwmVYo2l6VvCR7Tio4RfmxLvo6l8fYRexS0b492\\_vh7Z](https://encrypted-tbn0.gstatic.com/images?q=tbn:ANd9GcTfYxwmVYo2l6VvCR7Tio4RfmxLvo6l8fYRexS0b492_vh7Z) [https://encrypted-tbn0.gstatic.com/images?q=tbn:ANd9GcRM\\_LUanbCagZACYP93ym7\\_SXj5CaEz\\_CNG9-K36oSRQ](https://encrypted-tbn0.gstatic.com/images?q=tbn:ANd9GcRM_LUanbCagZACYP93ym7_SXj5CaEz_CNG9-K36oSRQ)

## THE DIFFICULTY OF TRADITIONAL CRAFTS' TRANSMITTING

Young people find traditional craft too demanding and instead seek work in factories or service industry where the work is less exacting and the pay often better. [2]

# Relevance

IF THE DECLINE OF THE TRADITION CRAFTS IS INEVITABLE,  
WHY SHALL WE PROTECT THEM ?

## THE TRADITIONAL CRAFTSMANSHIP IS REGARDED AS ONE OF THE INTANGIBLE CULTURAL HERITAGE

" Intangible Cultural Heritage means the practices, representations, expressions, knowledge, skills – as well as the instruments, objects, artifacts and cultural spaces associated therewith – that communities, groups and, in some cases, individuals recognize as part of their cultural heritage.

This intangible cultural heritage, transmitted from generation to generation, is constantly recreated by communities and groups in response to their environment, their interaction with nature and their history, and provides them with a sense of identity and continuity, thus promoting respect for cultural diversity and human creativity. "

---- Convention for the Safeguarding of the Intangible Cultural Heritage [3]

## DISSEMINATION AND PEOPLE REACTION

"We want to let more citizens realize the cultural heritage in Linhai" From the Director of Intangible Cultural Heritage Protection Center in Linhai. On the first Cultural Day Festival, the local government distributes the booklets introducing the traditional dancing, craftsmanships, poetries, which attracts a lot of people and get the positive responses.[4]

"I did not know we have so many cultural heritage in Linhai, I am very proud of it."  
---- from a pupil

There are a lot od similarities objects from the assembly line. However, the product by handcraft is full of heartwarming and emotion."

-----from a local citizen

# Bckground



## VENUE

My hometown----Linhai, like other hundreds of cities in China, has passions in preserving its own local culture.

## TARGET GROUP

My target group of this project is young citizen whose age from 20-30.

They are the generation who witnessed the decline of these traditional crafts —these objects they were familiar with during their childhood were almost disappeared when they grow up.

## COLLABORATOR

### MAY STUDIO



MAY studio is a creative platform based in Linhai. It aims to dig out the beauty of the city and reserve the old memories of this city from the local people.

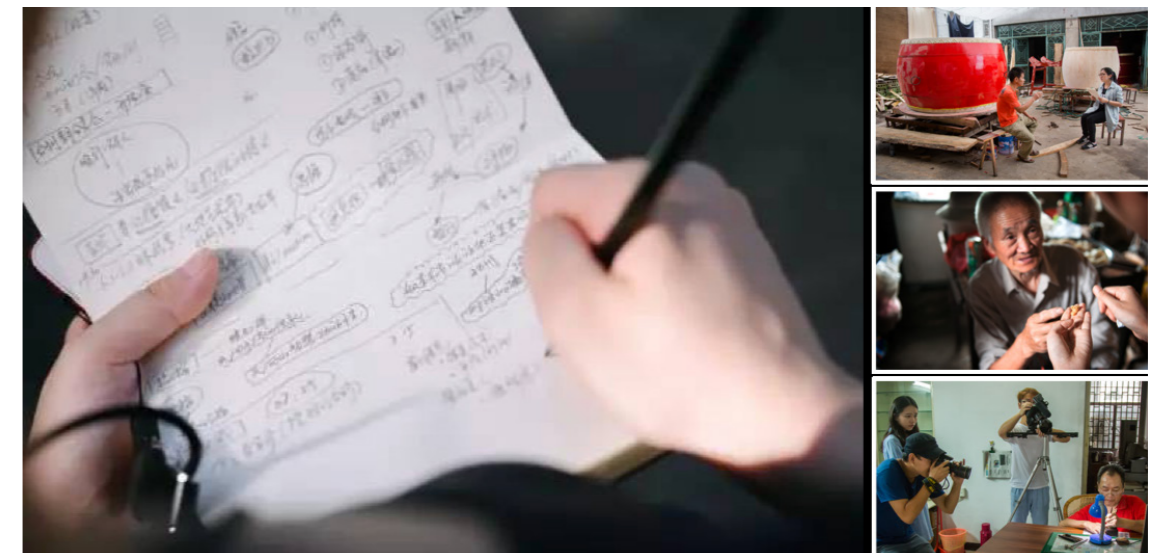

From the spring, May studio started to seek for artisans in my hometown, they have made a lot of efforts to preserve local traditional craftsmanship, They used photos and videos to document knowledge of craftsmanship and current situation of artisans. encourage more people to pay attention to the local craftsmanship.

I joined them in this summer and we have collected 20 crafts.



EXHIBITION ORGANIZER



LINHAI MUSEUM

LINHAI museum is a place for this traditional crasftsmanship exhibition.

Content: 20 types of craftsmanship

Opening time: 1st JAN ---- 31st March

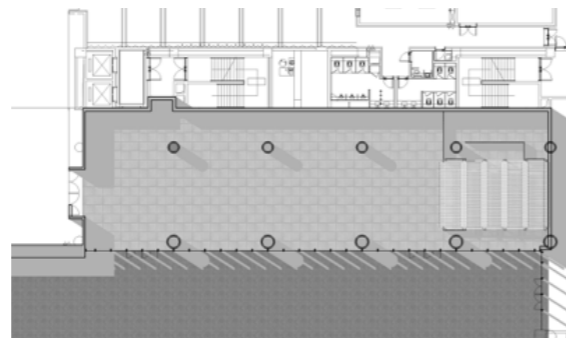

The name of the exhibition called LOCAL CULTURE.

20 types of local craftsmanship will be showing in this exhibition.

# Desgin challenge

The goal of my exhibit is not just to present stuff in front of visitors, but to use the interaction design as an approach to strike a chord, evoke visitors memories and have a longer impact on them.

## 1. HOW TO MAKE THE EXHIBIT DIFFERENT?

There are two types of exhibitions on the promotion of traditional craftsmanship, one is mainly showing handcrafted tools and products, and the other is showing videos of craft making process.

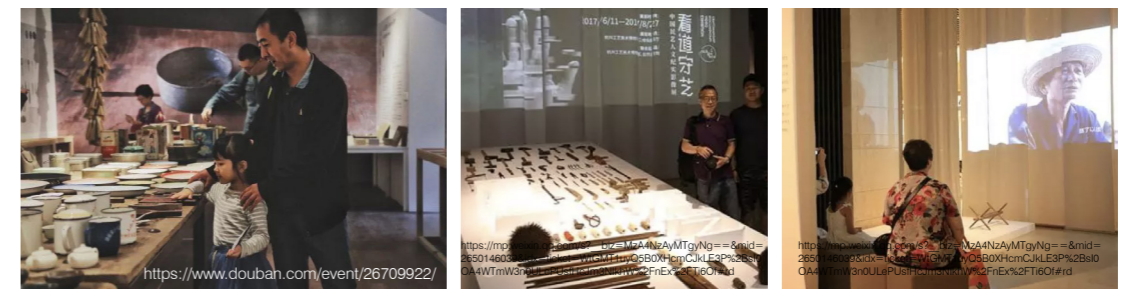

## 2. STRIKE A CHORD

The emotion is abstract and invisible, How can I make the exhibit have a sense of heartwarming feeling?



https://www.google.no/search?q=hand+fog&source=Inms&tbn=isch&sa=X&ved=0ahUKEwjXtrzfYbYAhUB-6QKHct6BUjQ\_AUICigB&biw=1680&bih=932#imgrc=I9EjXIX2\_7T vzM:



# CHAPTER02 RESEARCH

<b>02 RESEARCH</b>	_____	<b>19</b>
CASE STUDY	_____	<b>21</b>
DESK RESEARCH	_____	<b>22</b>
USER INTERVIEW	_____	<b>26</b>
BRIEF	_____	<b>31</b>

The research mainly focuses on three parts: existing cases analysis, desk research of selected craftsmanship and user interview.

The process of these three parts of research is overlapping.

After having overview understanding of research, I got some findings and the brief of this project.

# Case study

I did case studies to get to know what is the most important part in terms of traditional craftsmanship preservation and promotion.

The conclusion is: traditional craftsmanship calls for attention.

"There are so many things, people only know the name, they do not know what exactly it is."

"很多东西，大部分人只是听过，根本不了解具体怎么回事"



Shiwei Cai, dedicate himself making a book of recording all the process and details of the Wooden Movable type printing in Zhejiang Ruian Dongyuan village.[5]



"The first thing we do is to bring people to see the crafts making in person."

"我们首先做的一件事情，就是带人们去接触民艺。"

From children to elderlies, from scientist to Civil servants, Willa bring different kinds of people to see artisans, seeing how the beautiful craft works being produced.[6]

# Desk research

I chose bamboo craft as the selected craftsmanship for this project. I focus on bamboo articles to show how traditional craftsmanship have the influence in people's daily life.

I selected three representative craftsmanships out of 20 crafts: bamboo craft, cattail waving and Chinese steelyard making. I choose these three base on different features they have respectively.

The feature of bamboo craft focuses on the bamboo, the material itself, while cattail leaf waving is more about the way of procedure and the Chinese steelyard making is about its history and culture element. so in a way, these three crafts are representative regard to the rest of crafts.

1. bamboo is a kind of economically sustainable material, after a series of process, like splitting, bending, using the tenon mortise structure to joint each part, one bamboo is able to be a piece of furniture.

2. The delicacy and beauty of a pure handmade cattail leaf objects lean on the weaving. the artisan uses the different way of waving to make a handful of grass into a fan, a lamp and so forth with different patterns and shapes

3. Chinese steelyard is a type of portable scale, with the long using history in China. the story behind the invention expresses a good wish for the people who use it to keep fair.

In order to have more knowledge and a solid understanding of these crafts. I started to do more research, mainly focus on three parts: techniques, history, and people around them. I had the desk research and consulted the experts to get to know techniques, history, and culture. my partner helped me to contact the artisan to get their personal stories and the current situations.

Finally, I chose bamboo craft as the focus. I collected the material and knowledge about from the raw material the bamboo itself. To the production technique, the culture element, finished product, artisans story and impressions from users.

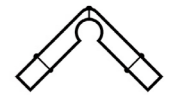
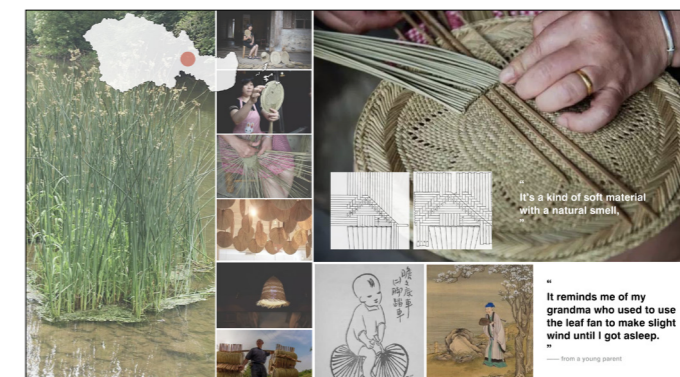
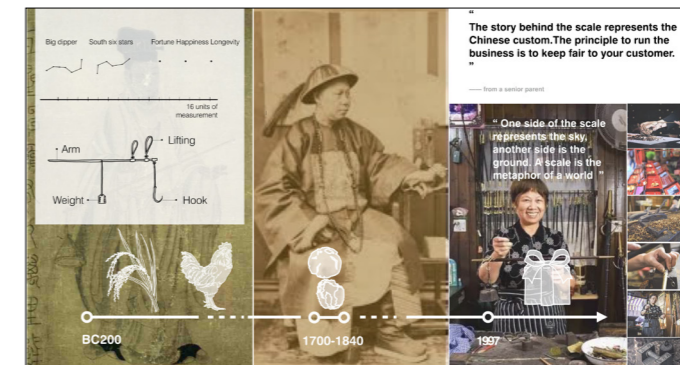

竹椅  
岁月老

竹匠人 彭加宇



象法天地  
一杆秤

衡天 衡地 衡人



蒲扇  
岁月长

蒲扇匠人 彭加宇



<http://kai ping.89ys.com/predetail/60176>

SPRIT SYMPOLE  
FEATURE  
HISTORY

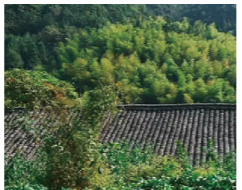

ARTISAN  
PRODUCTION

EMPAZISE  
BAMBOO ARTICLES

There are different aspects of bamboo crafts could be further explored, I chose traditional bamboo articles to emphasize due to the reason that bamboo articles are close to people's lives and have an influence on people's live behavior.

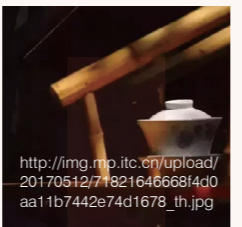
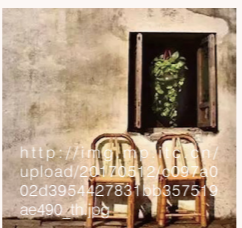

[http://img.mp.itc.cn/upload/20170512/7182164666814d0aa11b7442e74d1678\\_th.jpg](http://img.mp.itc.cn/upload/20170512/7182164666814d0aa11b7442e74d1678_th.jpg)

USAGE  
LOCAL CUSTOME

DAILY LIFE



" Handicrafts had been around and have an influence on people's daily life."

Monk Lu, a Cultural scholar in Linhai



" The best way to protect the traditional craft is to integrate it into daily life. "

Soetsu, the leader of the craft revolution in Japan. [7]



BAMBOO ARTICLES

There are five pieces of representative bamboo articles I collected.



竹箩

BAMBOO BASKETS



刷帚

BAMBOO BRUSH



竹储蓄罐

BAMBOO MONEY-BOX



竹根烟斗

BAMBOROOT PIPE



木勺

BAMBOO SCOOP

# User interview

Word-of-mouth was founded as a way to present young people the knowledge of handicraft.



## INTERVIEW CONTENT

Interviewees:  
4 young citizens, 4 senior citizens  
Duration: 40 mins/each  
Type: Semi-structured interviews  
Method: remote interview

With help of my partners, I had remote interviews with my target group, local young citizens whose age from 20 to 30. In order to fully understand knowledge gap between different generations. I also interviewed four senior adults.

Then I had some findings from interviews.

## PERSONA

I got two personas after analyzing interview results. Wang Chen, a 28-year-old young citizen, and a 57 year old senior citizen Zhang Yansong.

The bar chart shows how familiar level of the knowledge to the corresponding issue related to bamboo craft.

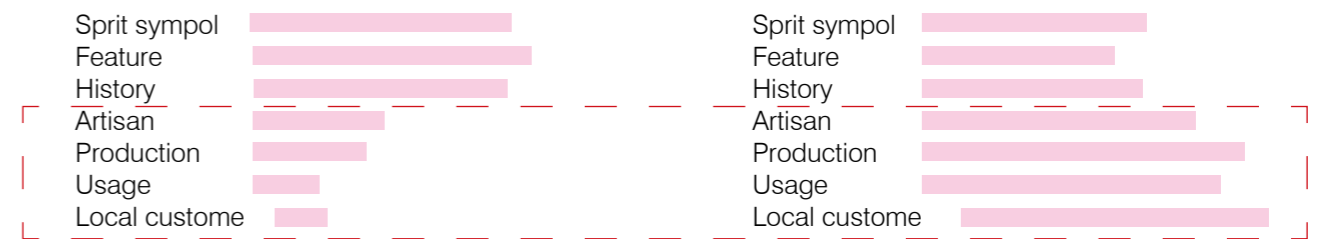

## RESULT AFTER COMPARISON

Young people lack the knowledge on the ground.

Comparing their knowledge structure of the bamboo craft, both young people and senior people have the same level of general knowledge of the bamboo crafts. However, senior people are more knowledgeable about local and traditional customs. Knowledge of crafts related to local and traditional customs is shared by word of mouth, not through books or media. For the parts of knowledge, they lack, young people, show a strong interested in learning more about them.

Young people have three common feature when they talked about the traditional crafts:  
CHILDHOOD MEMORY, HEARTWARMING FEELING,  
AND GRANDPARENTS

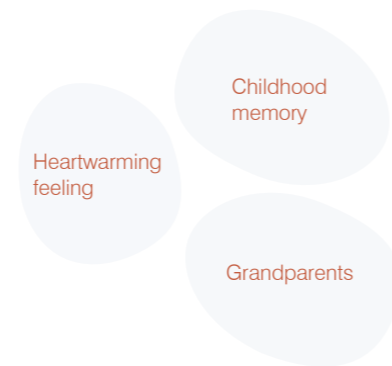

### COMMON FEATURES

Young people's memory of handcrafts focuses on their childhood period.

These memories always relate to warm and happy feelings and especially memories with their grandparents or other senior people.

**"I remember when I was a child  
I always listened to my grandma  
telling stories"**

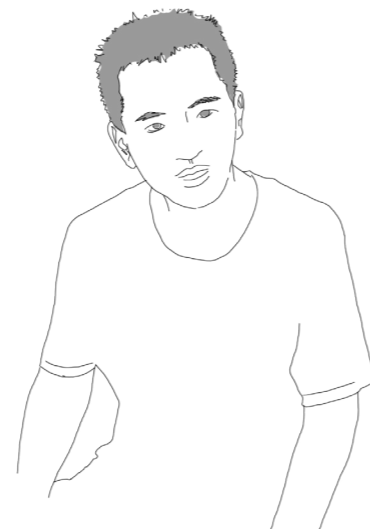

Young adult appreciates the memories of the time they spend together with their grandparents. listening to the story told by the elders is an original way to learn new knowledge.

So I decide to use the **word of mouth** as a key element of my project, make it as a medium for the visitors to get to know the knowledge of the bamboo craft.

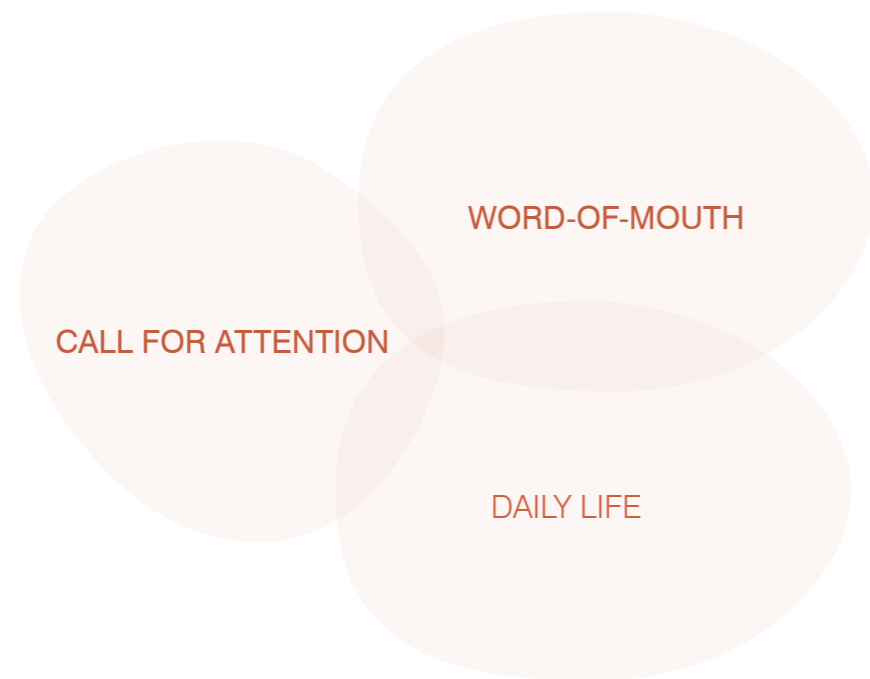

## Brief

To use word of mouth as a key element in my project, show young people knowledge of traditional bamboo articles.

Combining with interaction design method through the exhibit, bring young people a sense of heartwarming experience, thus to build a closer relationship with the bamboo craft.





# CHAPTER 03 CONCEPT AND PROTOTYPE

<b>03 CONCEPT AND PROTOTYPE</b>	_____	<b>33</b>
INSPIRATIONS	_____	34
SKETCH AND SCALED MODEL	_____	36
CONCEPT DEVELOPMENT	_____	40
CONCEPT OF THE AUDIO DEVICE	_____	46
SIMULATION	_____	52

# Inspirations

For the design part, I start from collecting some inspirations. Learning to see how do people interact with the sound devices, how do they receive the information related to the content or device at the exhibit.



SOUND DEVICE AND PEOPLE'S ACTION

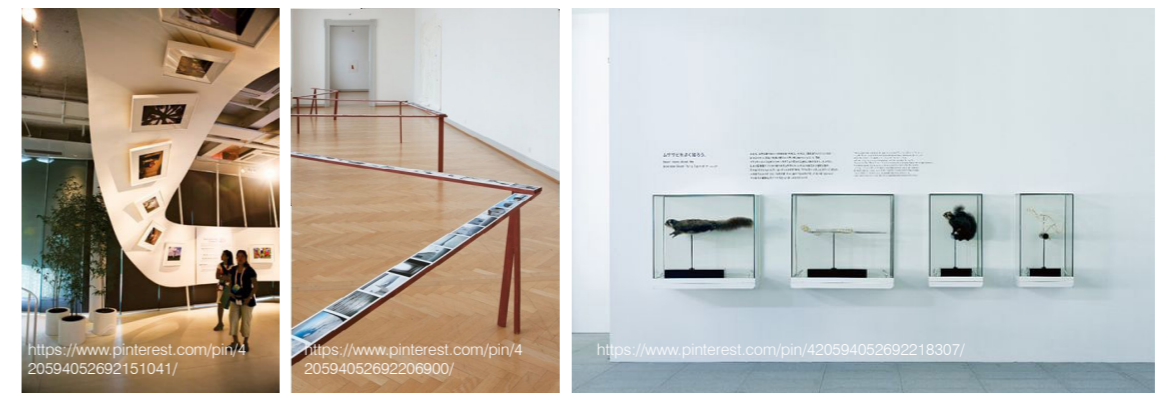

STRUCTURE OF AN EXHIBIT: CONTENT AND VISUAL FLOW

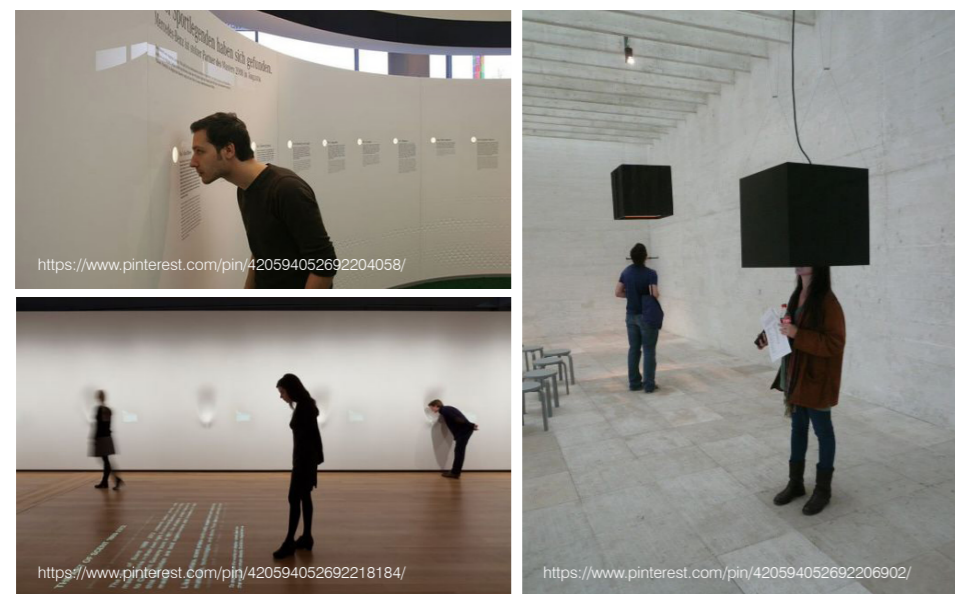

PEOPLE'S BODY LANGUAGE WHEN THEY RECEIVE THE INFORMATION



TANGIBLE INTERACTION AND PEOPLE'S RESPONSE.



## THREE SELECTED CONCEPTS

There are several concepts I came up, consider the practical issue, e.g, cost, time and implement, I chose the third concept and start to consider more details.

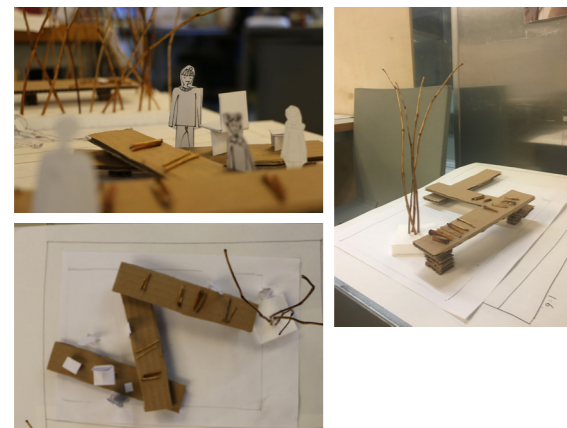
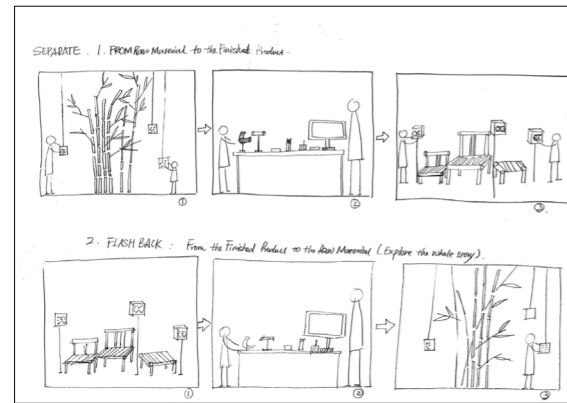

### 01 GUIDED TOUR

The first concept is *guided tour*, the exhibit structure is set into three parts. Visitors can go from the raw material to the production process and then is the finished objects. If they go the opposite way they can start with the finished objects and end up with the raw materials. Each part has the corresponding audio device.

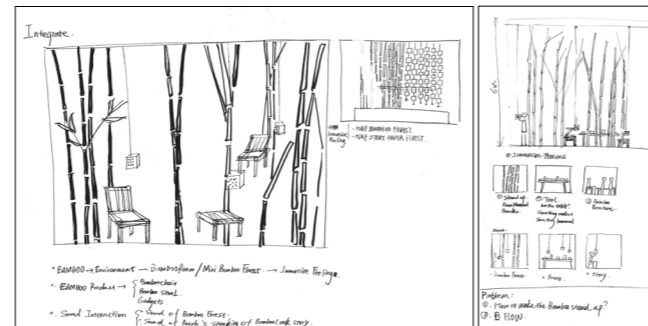

### 02 NATURE SOUND

The second concept gives visitors immersive feeling, help visitors fully involve themselves in the environment. use a lot of bamboos to make the bamboo forest, put a big worktable in the middle to simulate artisans' workshop. with a lot of finished bamboo product set in the different corner. Visitors can sit down and listen to the story.

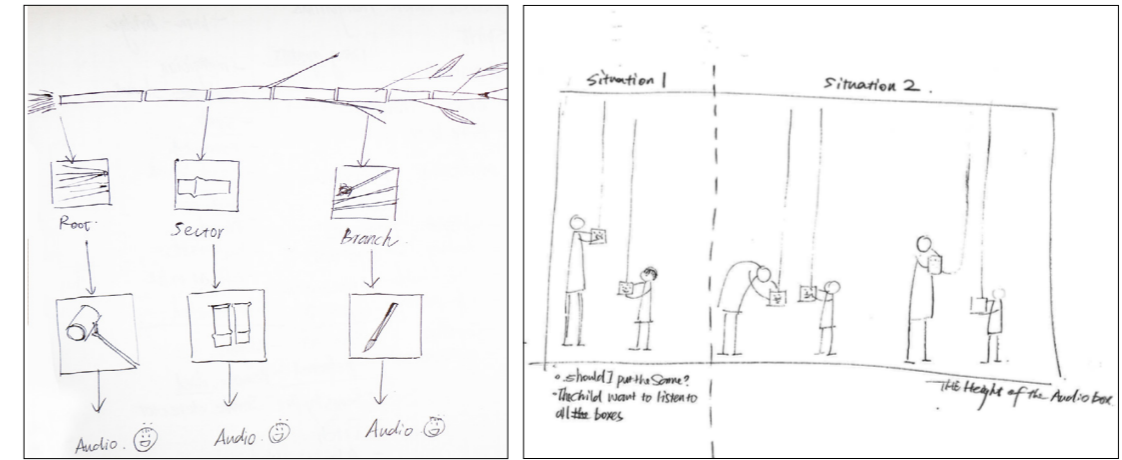

### 03 WHISPER

Different section of a bamboo can be made of different bamboo product, so the exhibit structure starts from one bamboo, different pieces of the bamboo, the corresponding objects and stories.

Everything is hanging up, bamboo objects with story boxes are hanging on both sides of the bamboo visitors can stand around and pick the one they like to hear the story.

Finally, I selected the third concept and start to get more details.

# Concept development

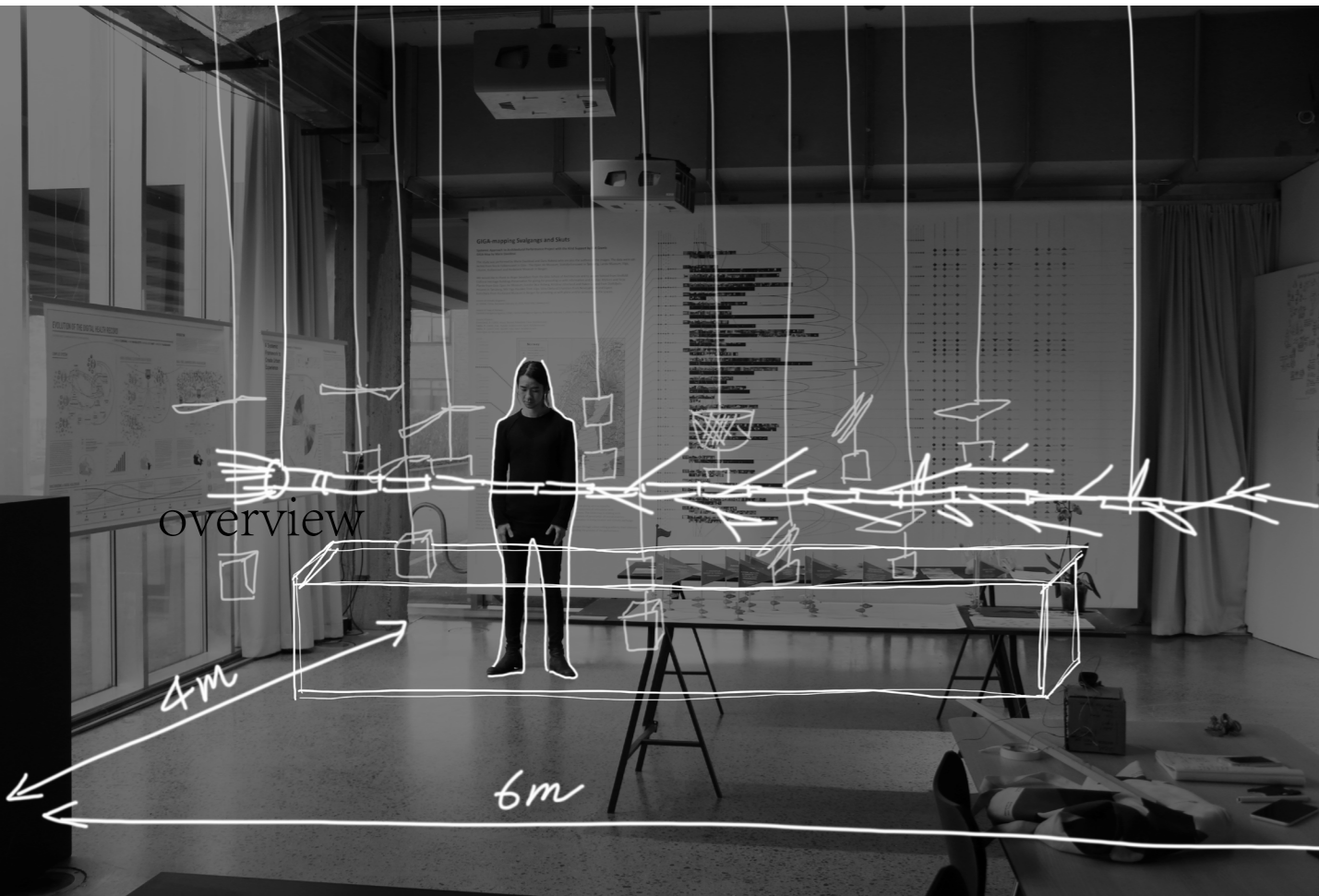

## SPACE FEELING

I found a space the size is same as my exhibit area which is 6m\*4m, so I can have a sense of space feeling.

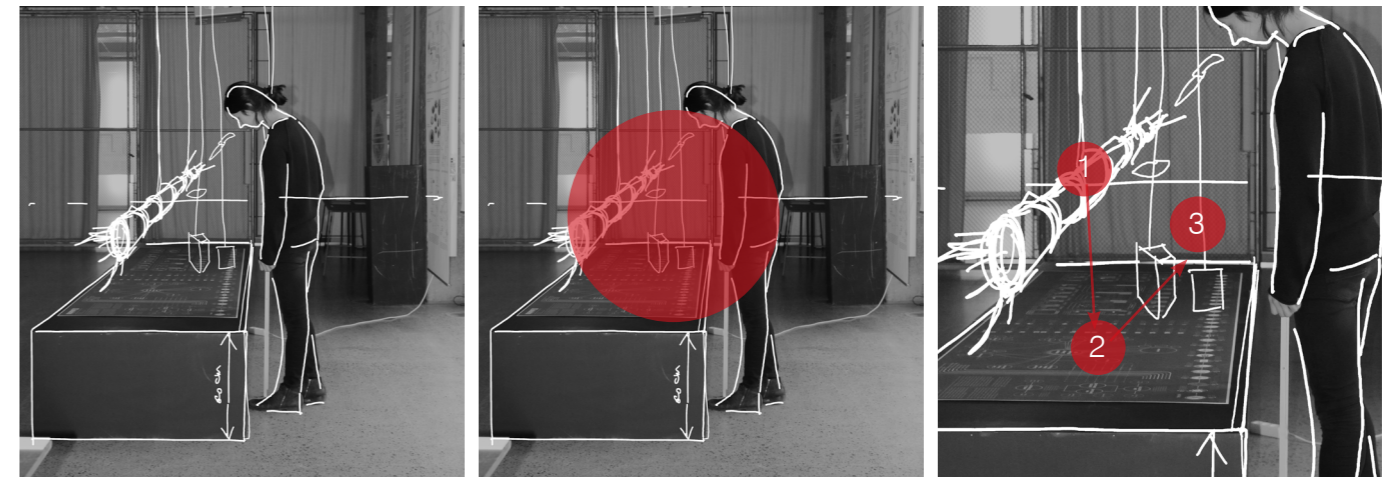

## CONTENT

### 1 BAMBOO

Length: 4 meter  
Feature: whole piece of bamboo with root and branch

### 2 A LONG TABLE AND BAMBOO ARTICLES

Table: height 0.6 meter, length: 4.8 meter width 0.8 meter.  
Bamboo articles: should be representative and made out of different part of a bamboo.

### 3 AUDIO DEVICE

Content: story  
Positive response:  
When visitors close to the audio box, it will have positive response encourage visitors to listen.

## VISUAL FLOW

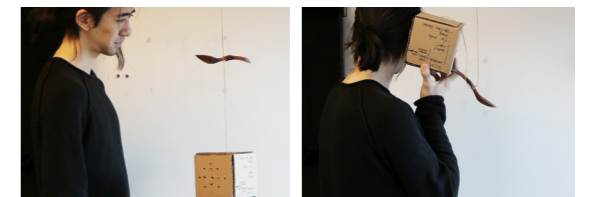

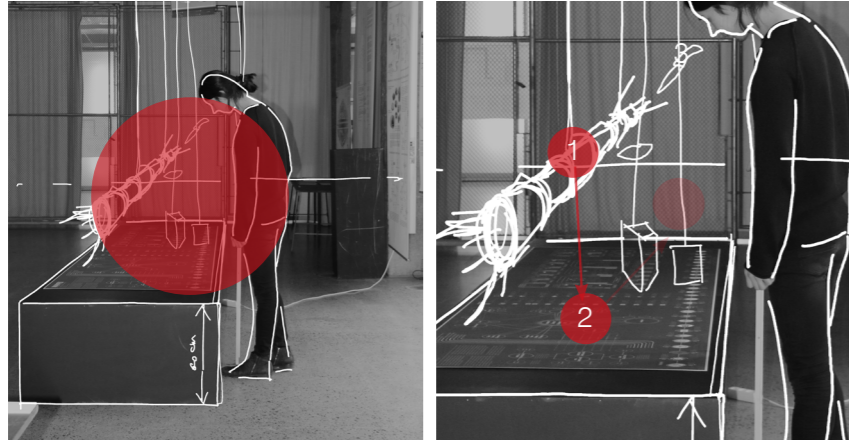

SEQUENCE

Different bamboo articles are made of different part of a bamboo,  
 In this case, the layout of the bamboo articles on the table is according to the corresponding part of the bamboo.



竹箩

BAMBOO BASKETS



刷帚

BAMBOO BRUSH



竹储蓄罐

BAMBOO MONEY-BOX



竹根烟斗

BAMBOOROOT PIPE



木勺

BAMBOO SCOOP

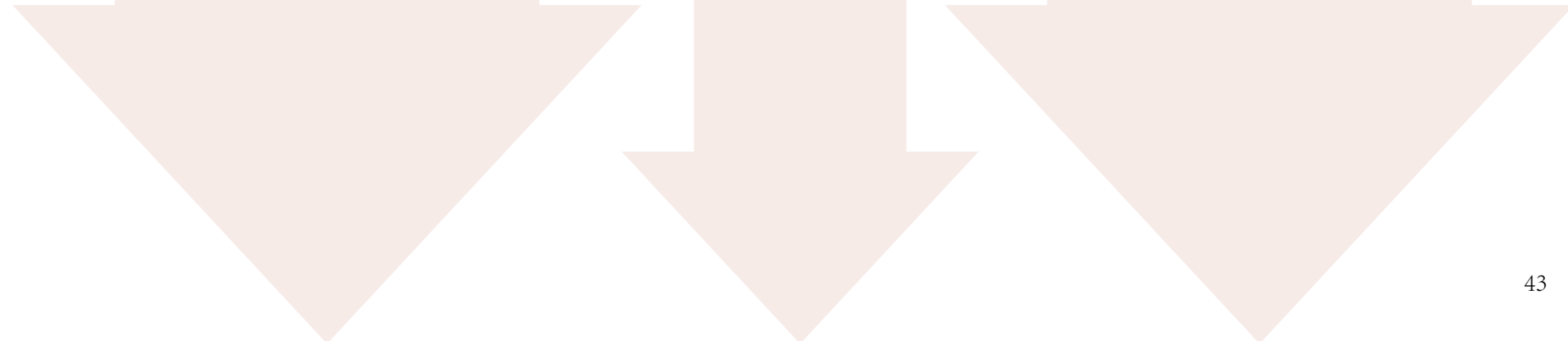

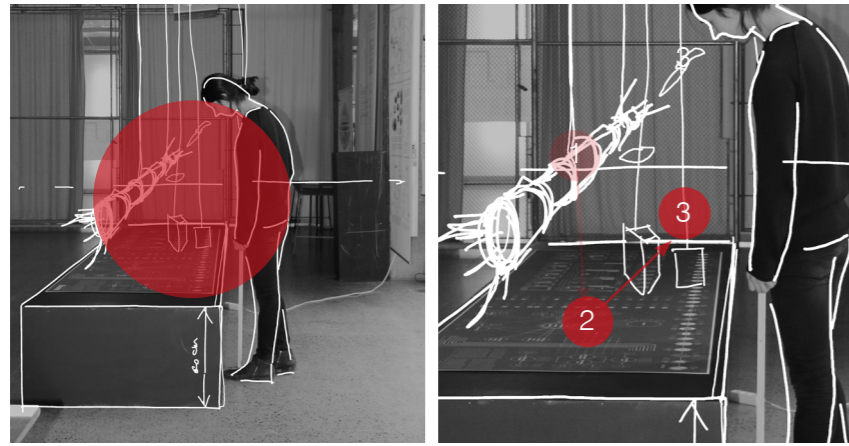

### CONNECTION

The content of the table is bamboo articles with a corresponding quote, which extract from the story told by a senior citizen.

这个，我们临海人叫饭箩，其他地方的人叫这个是灶篱。  
饭箩呢，我们主要是用来洗米用的，放米饭用。用这个来洗米的话，水可以渗漏下去，这样就可以把米洗得很干净。这个饭箩是镂空通风的，要是用来盛米饭，放在这里不会坏掉。有时候米饭做多了吃不完就先放着，明天再吃。  
我们把饭箩挂在厨房的梁上，我们用一个小架子，用细竹条做的三角形的架子，挂在厨房的梁上，挂得高高的。饭箩放在三角架子上面，用纱布盖住，透气又通风，又容易干燥，苍蝇蚊子也进不去，很卫生。  
有时候这个饭箩闲置空着，我们就把蔬菜放在里面。

——毛阿婆

我们把饭箩挂在厨房的梁上

### EXTRACT FROM A STORY

For each piece of bamboo article, I extracted one representative sentence from the corresponding story, made it as a hint to inspire visitor's curiosity.



饭箩

.....我们把饭箩挂在厨房的梁上....."  
——毛阿婆

The single sentence looks odd. However, it makes sense after visitor r listening to the whole story.

# Concept of the audio device



## THE SHAPE AND APPEARANCE OF THE AUDIO DEVICE

The audio box was decided to use bamboo sector directly.

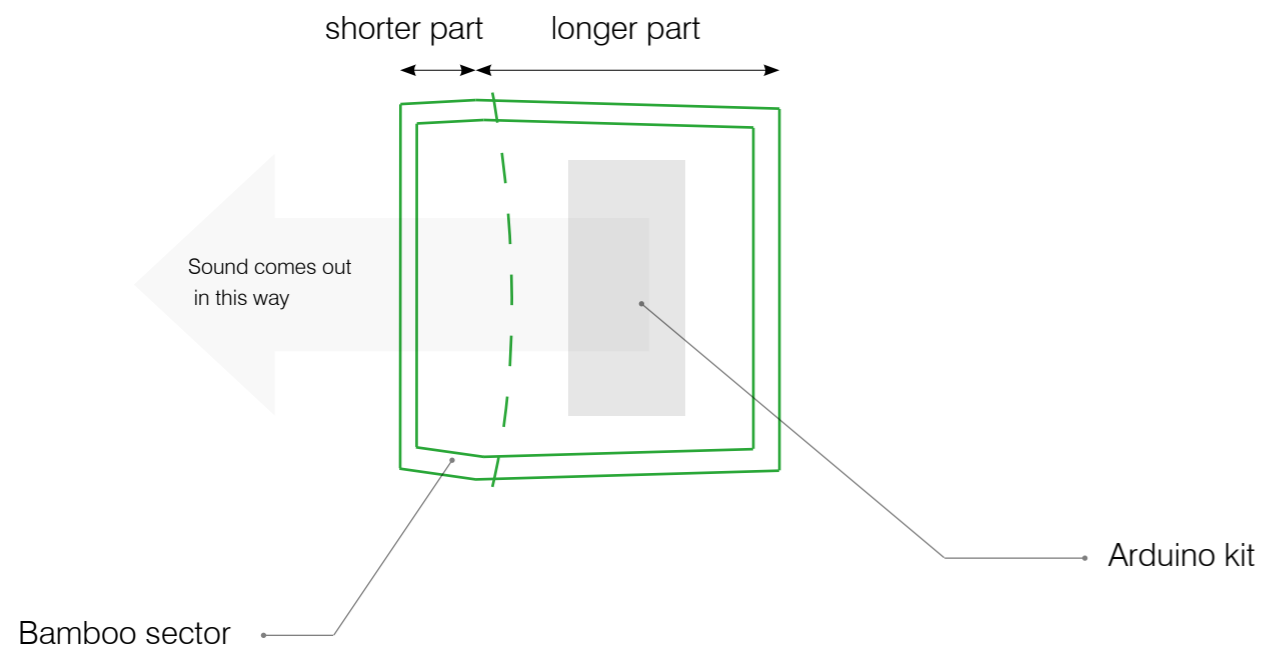

## RAPID MODELING

Since I can't get bamboo as material to test, I used cupboard paper to build quick models, to define the appropriate size, assemble and use scenario of the concept.



## COMPARE TWO WAYS OF HANGING UP

After a quick test, I chose the hanging 01.



Hanging 01:  
hanging the audio device on the side.

Feedback: With visible holes on the side, It looks like a speaker.

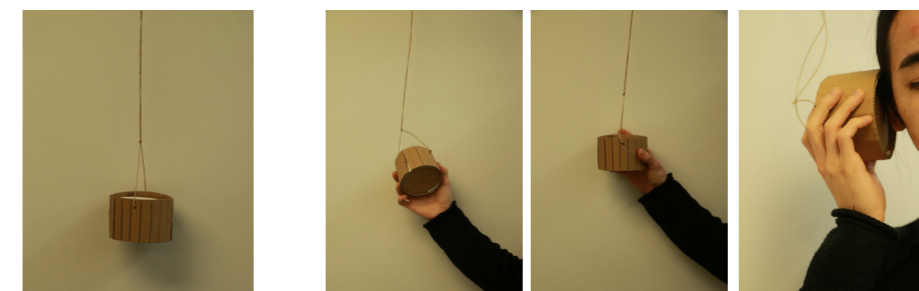

Hanging 02:  
hanging the audio device on the bottom.

Feedback: It appears to a lamp. And it needs to be flipped before listening, more than one step compared to the hanging01.



## ARDUINO KIT

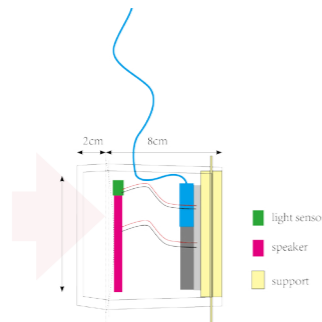
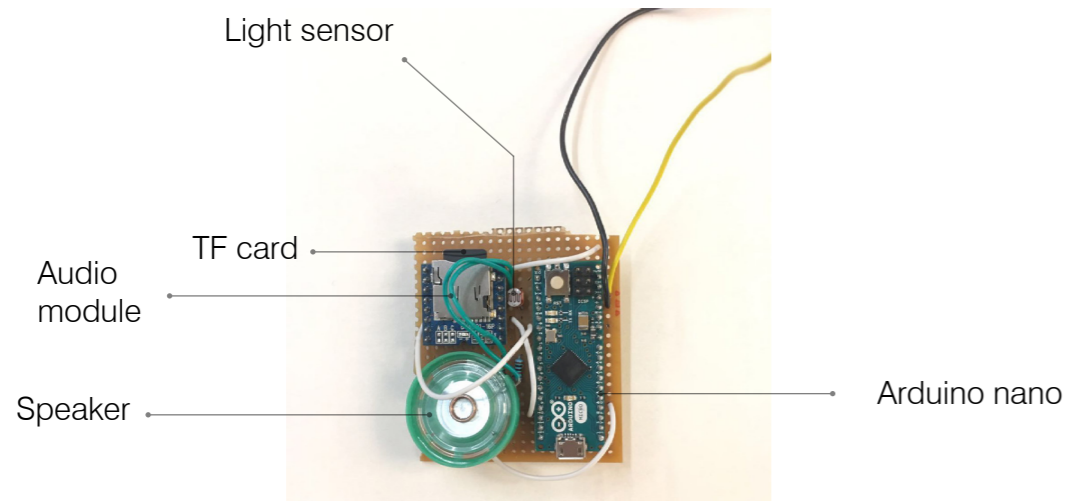

## AUDIO DEVICE LAYOUT

The light sensor can detect the change of the brightness, and it trigger the arduino nano board to have the change of the sound.

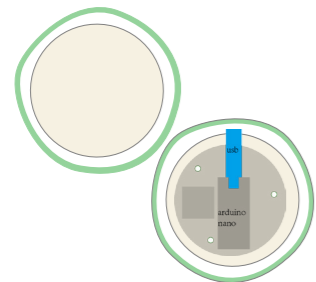

## ASSEMBLE THE ARDUINO KIT AND THE BAMBOO SECTOR.

The size of each bamboo sector is slightly different. So I think it's better to have a module which the size is smaller than the bamboo sector, so it turns to find a way to combine the module and bamboo sector.

## DIFFERENT RESPONSE TESTING

Click to watch video



```

speak_1.0
//
#include <SoftwareSerial.h>
#include <Arduino.h>
// function prototype
bool checkForMp3FileOpen();
SoftwareSerial mp3Serial(18, 9); // RX, TX
BYRON1 mp3; // creating an instance of class BYRON1 and call it 'mp3'

int LightSensor = 0;
int threshold = 250; // change this value down to increase sensitivity
long currentFlow; // time between readings
long currentFlow; // time between readings
int byRON1_VolumeSetting = 4; // Set volume to 15 (0-30 range) if not already set

void setup() {
  Serial.begin(9600); // set serial monitor baud rate to Arduino IDE
  mp3Serial.begin(9600); // BYRON1 set to 9600 baud (required)
  mp3.setBaudRate(9600); // tell BYRON1 library which serial port to use.
  delay(200); // allow time for BYRON1 cold boot; may adjust depending on flash storage size
  char * folderName = mp3.getFolderName();
  Serial.println(folderName);
  Serial.println("BYRON1 module firmware version: ");
  Serial.println(mp3.getFirmwareVersion());
  //set byRON1_VolumeSetting = 4; // Set volume to 15 (0-30 range) if not already set
  if ((int)mp3.getVolumeSetting() != byRON1_VolumeSetting) mp3.setVolume(byRON1_VolumeSetting);
  mp3.setBaudRate(9600);
  int volume = mp3.getVolumeSetting(); // just verifying has been set before serial print to console
  Serial.println("speaker volume setting: ");
  Serial.println(volume);
  mp3.stopPlayback();
  mp3.playTrack(1);
  Serial.println("number of files on micro SD-card: ");
  Serial.println(mp3.getTrackCount());
  mp3.stopPlayback();
}

void loop() {
  if (mp3.isPlaying()) {
    if (currentFlow > 1000) {
      if (currentFlow > 1000) {
        mp3.setVolume(1);
        mp3.setVolume(1);
      }
    }
  }
}

```

SILENT ---- SPEAK

```

speak_1.0
//
#include <SoftwareSerial.h>
#include <Arduino.h>
// function prototype
bool checkForMp3FileOpen();
SoftwareSerial mp3Serial(18, 9); // RX, TX
BYRON1 mp3; // creating an instance of class BYRON1 and call it 'mp3'

int LightSensor = 0;
int threshold = 250; // change this value down to increase sensitivity
long currentFlow; // time between readings
long currentFlow; // time between readings
int byRON1_VolumeSetting = 4; // Set volume to 15 (0-30 range) if not already set

void setup() {
  Serial.begin(9600); // set serial monitor baud rate to Arduino IDE
  mp3Serial.begin(9600); // BYRON1 set to 9600 baud (required)
  mp3.setBaudRate(9600); // tell BYRON1 library which serial port to use.
  delay(200); // allow time for BYRON1 cold boot; may adjust depending on flash storage size
  char * folderName = mp3.getFolderName();
  Serial.println(folderName);
  Serial.println("BYRON1 module firmware version: ");
  Serial.println(mp3.getFirmwareVersion());
  //set byRON1_VolumeSetting = 4; // Set volume to 15 (0-30 range) if not already set
  if ((int)mp3.getVolumeSetting() != byRON1_VolumeSetting) mp3.setVolume(byRON1_VolumeSetting);
  mp3.setBaudRate(9600);
  int volume = mp3.getVolumeSetting(); // just verifying has been set before serial print to console
  Serial.println("speaker volume setting: ");
  Serial.println(volume);
  mp3.stopPlayback();
  mp3.playTrack(1);
  Serial.println("number of files on micro SD-card: ");
  Serial.println(mp3.getTrackCount());
  mp3.stopPlayback();
}

void loop() {
  if (mp3.isPlaying()) {
    if (currentFlow > 1000) {
      if (currentFlow > 1000) {
        mp3.setVolume(1);
        mp3.setVolume(1);
      }
    }
  }
}

```

AUDIO VOLUMN RAISING

```

buzz-clear.0
//
#include <SoftwareSerial.h>
#include <Arduino.h>
// function prototype
bool checkForMp3FileOpen();
SoftwareSerial mp3Serial(18, 9); // RX, TX
BYRON1 mp3; // creating an instance of class BYRON1 and call it 'mp3'

int LightSensor = 0;
int threshold = 250; // change this value down to increase sensitivity
long currentFlow; // time between readings
long currentFlow; // time between readings
int byRON1_VolumeSetting = 4; // Set volume to 15 (0-30 range) if not already set

void setup() {
  Serial.begin(9600); // set serial monitor baud rate to Arduino IDE
  mp3Serial.begin(9600); // BYRON1 set to 9600 baud (required)
  mp3.setBaudRate(9600); // tell BYRON1 library which serial port to use.
  delay(200); // allow time for BYRON1 cold boot; may adjust depending on flash storage size
  char * folderName = mp3.getFolderName();
  Serial.println(folderName);
  Serial.println("BYRON1 module firmware version: ");
  Serial.println(mp3.getFirmwareVersion());
  //set byRON1_VolumeSetting = 4; // Set volume to 15 (0-30 range) if not already set
  if ((int)mp3.getVolumeSetting() != byRON1_VolumeSetting) mp3.setVolume(byRON1_VolumeSetting);
  mp3.setBaudRate(9600);
  int volume = mp3.getVolumeSetting(); // just verifying has been set before serial print to console
  Serial.println("speaker volume setting: ");
  Serial.println(volume);
  mp3.stopPlayback();
  mp3.playTrack(1);
  Serial.println("number of files on micro SD-card: ");
  Serial.println(mp3.getTrackCount());
  mp3.stopPlayback();
}

void loop() {
  if (mp3.isPlaying()) {
    if (currentFlow > 1000) {
      if (currentFlow > 1000) {
        mp3.setVolume(1);
        mp3.setVolume(1);
      }
    }
  }
}

```

BUZZ ---- CLEAR

## SIMULATION SCENARIO

In this part, I have made three scenarios of the interaction effect between people and audio device.  
After compare three scenario, I chose the second one in the end.

### SILENT --- SPEAK



[Click to watch video](#)

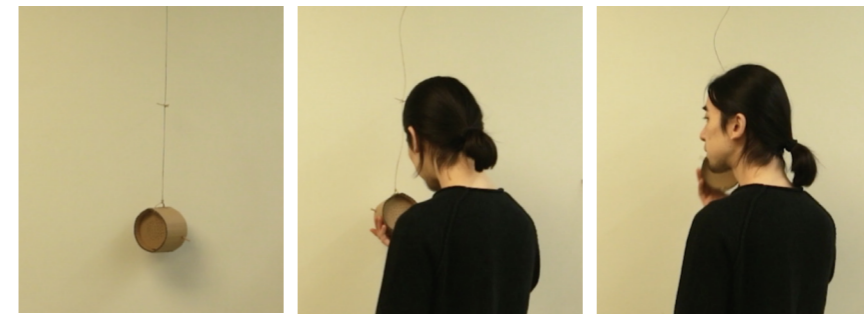

1,

The audio box keep silent at first.

2,

When people get closer.

3,

The audio box starts to have sound

Feedback:

There is no clue for visitors to know the audio device makes a sound.

### AUDIO VOLUME RAISING

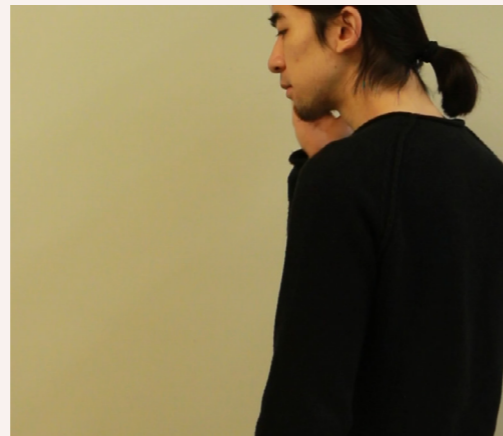

[Click to watch video](#)



1,

The audio box keep making sound in a low voice.

2,

The volumn of the voice get increasing when people get closer.

Feedback:

When people listen to the story, they start from the middle of the story which makes them confused.

### BUZZ --- CLEAR

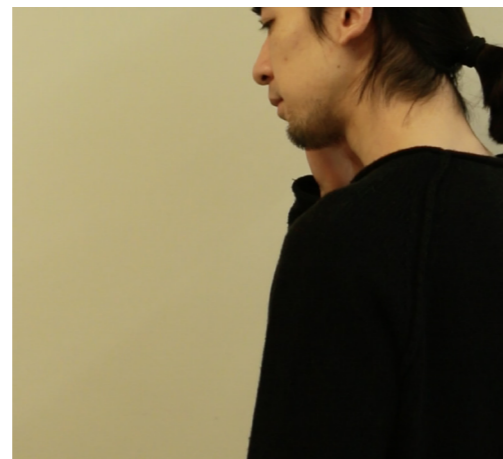

[Click to watch video](#)



1,

The audio box keep making low quality sound

2,

When people put it close to ear, the sound turn to be clear.

Feedback:

f the audio device starts by making noisy, People won't put it close to their ears.

# Simulation

I simulated an exhibit, trying to have a sense feeling of space, to know the position of people and objects.

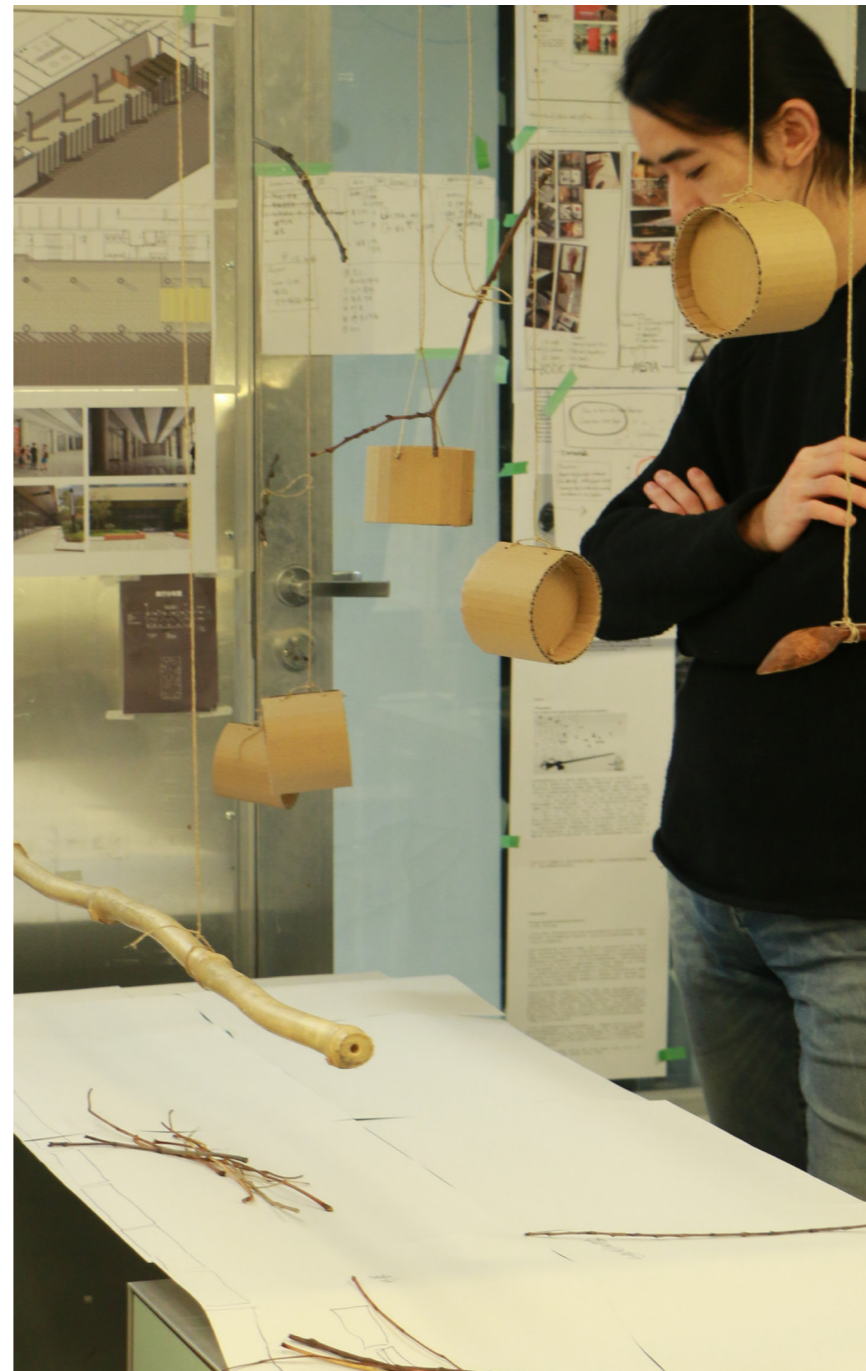
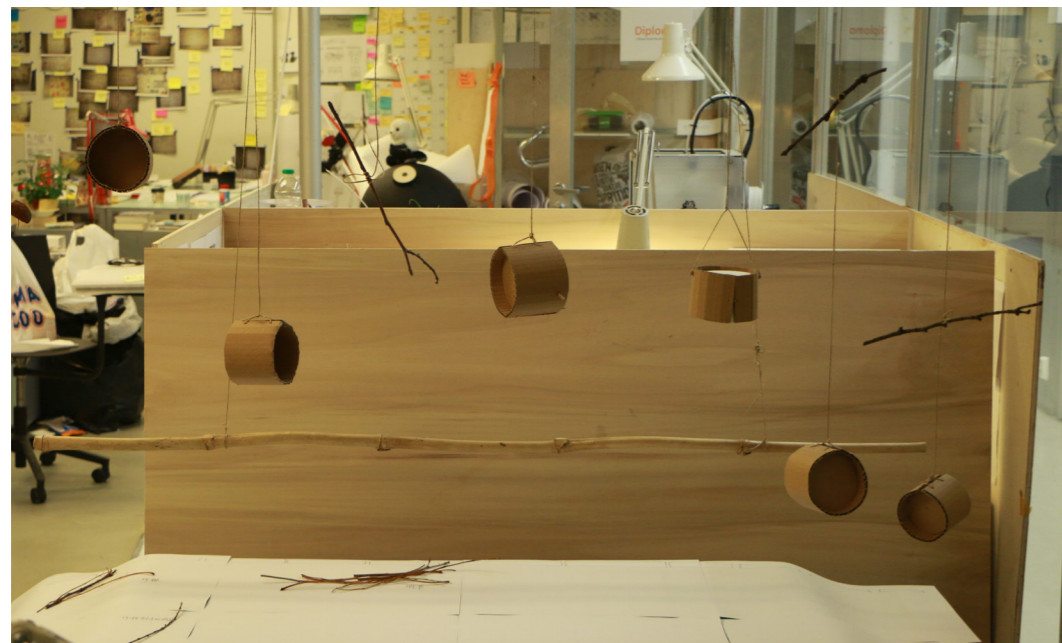

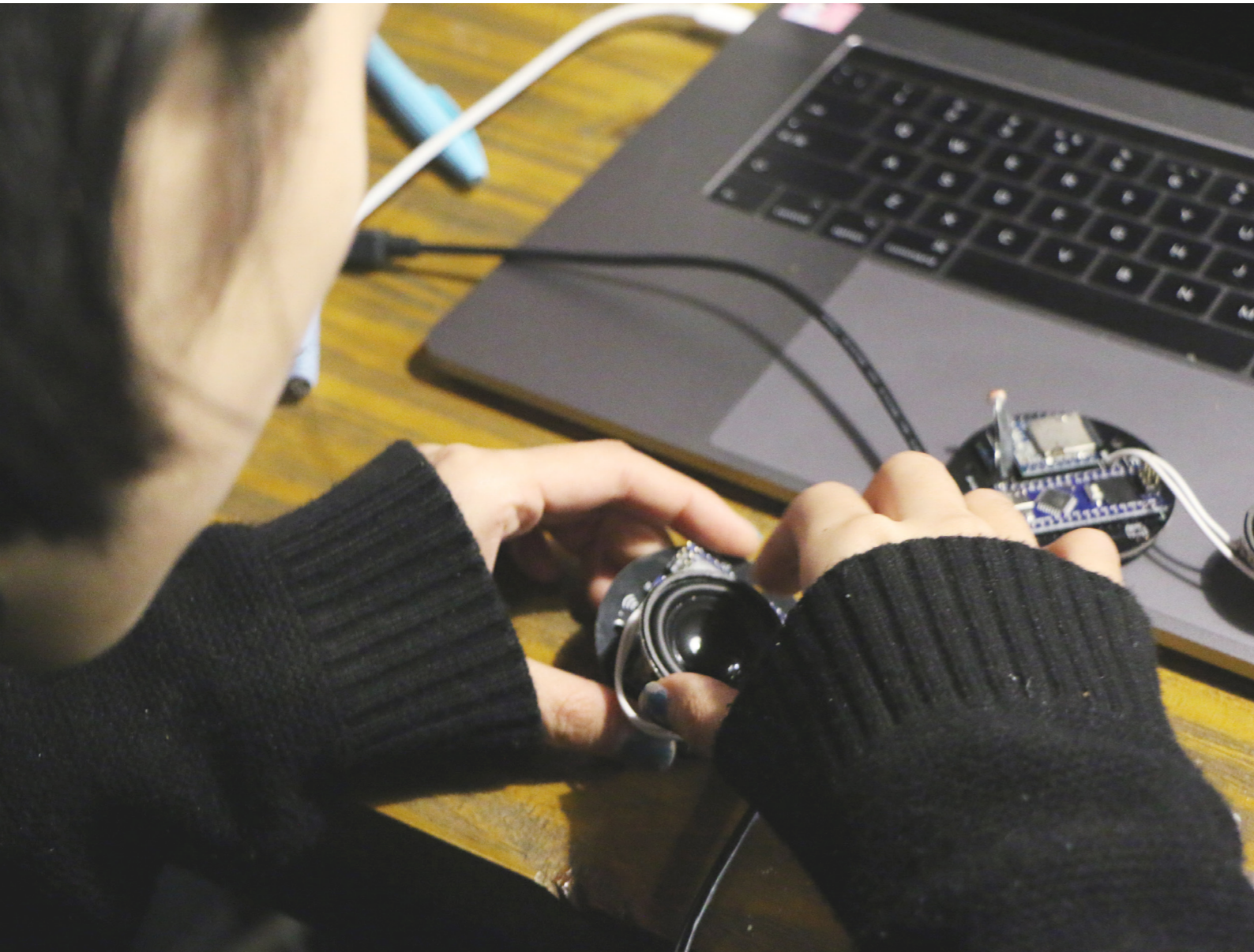

## CHAPTER 04 IMPLEMENT AND FEEDBACK:

04 IMPLEMENT AND FEEDBACK	55
OVERVIEW	56
AUDIO DEVICE PRODUCTION	58
STORY RECORDING AND EDITING	64
RESULT	66
FEEDBACK AND IMPACT	72
DESIGN POSSIBILITY	76
REFLECTION	78

This chapter shows the implement process of the final result of this project -- an exhibit named WHISPER and some feedbacks from visitors.

# Overview

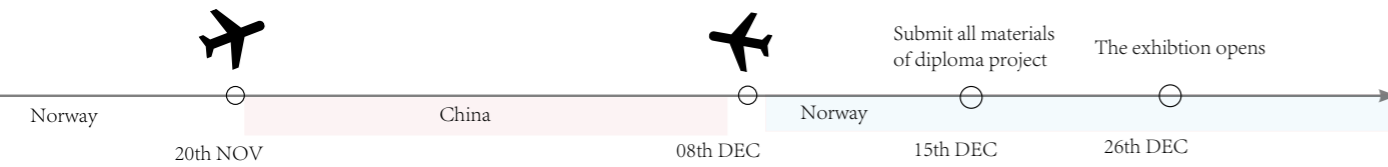

I flew to China on 20th November and stayed there for three weeks. I had implement my bamboo craft exhibit in a small sclaed. Besides, I assited to help other craft exhibits.

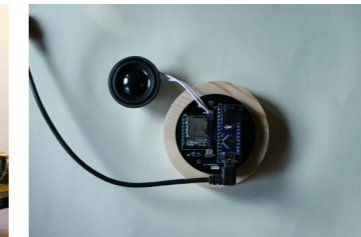

I had made plenty of audio devices, which took me a lot of time.



I met bamboo craft artisan PENG JIAXUE on XIN TAN mountain, he helped me process bamboo for making audio devices and give me all bamboo materials I need .



The exhibition will be open on 26th DEC. I was not allowed to implement stuff until 15th Dec. So I sought for an appropriate place to have my exhibit implement on a small scale.

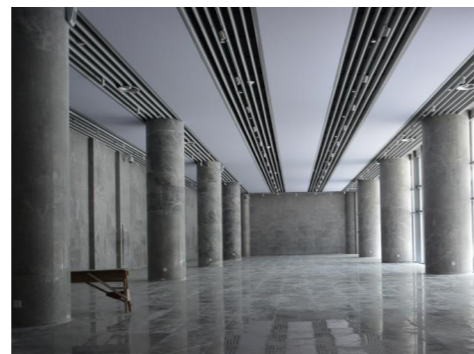

I went to the LINHAI museum to check the exhibit area of my BAMBOO craft.



The temporary exhibit lasted for one day, I documented feedbacks from visitors and then tore everything down. I organized them in order so my partner could help me to implement them in the museum afterwards.

# Audio device production



An appropriate size of Bamboo was selected. It was produced as the "shell" of the audio box. The diameter of the "shell" is around 32cm and the length is around 10 cm.



The edge of the bamboo was sharp after cutting, so it was polished avoiding hurting users.



Holes were drilled by Hand drill. For each hole, the shape and the size of holes is slightly different, which makes every single bamboo audio device unique.

## REFLECTION:

The bamboo's layer is thicker than I thought, which cause the whole size of the audio device bigger than I thought. On the other hand, the weight of one bamboo sector is also heavier than I thought.

As a result, I realize it's necessary to get the real material on hand and test it as soon as possible during the design process.



The surface of bamboo layer is not flat, so the drill should drill it with different angles.

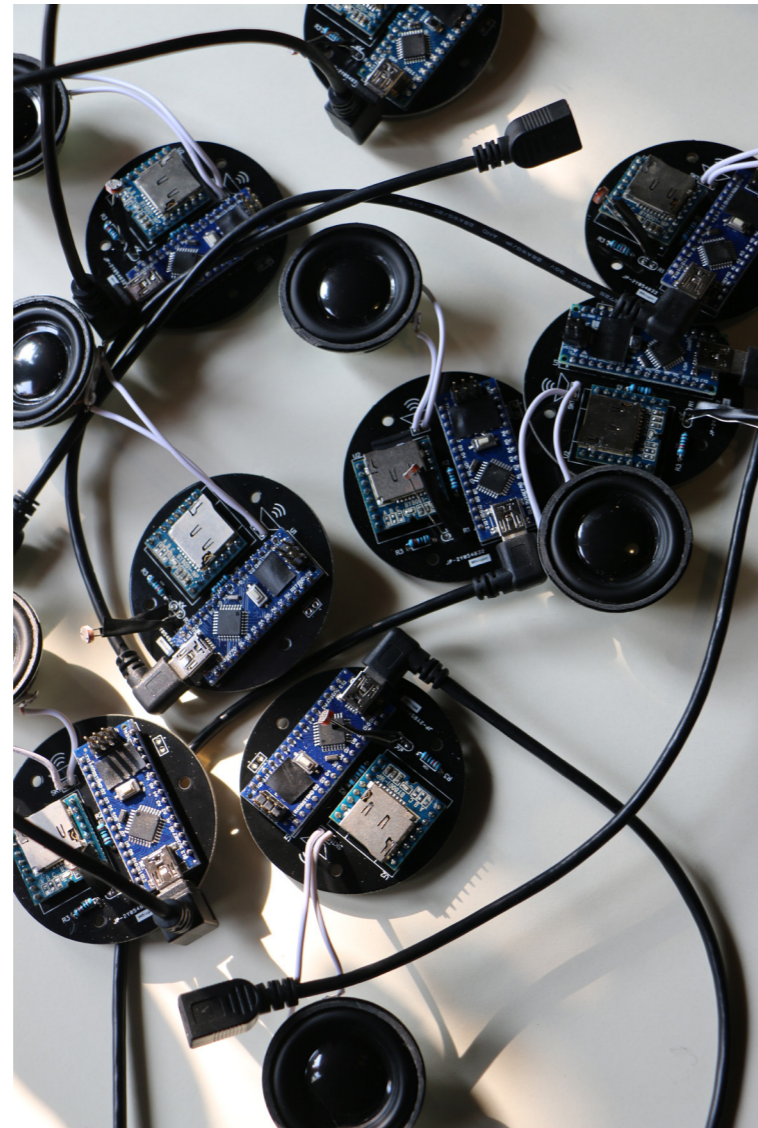
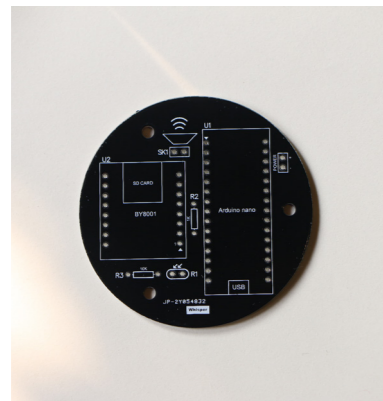
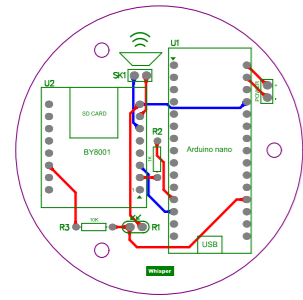
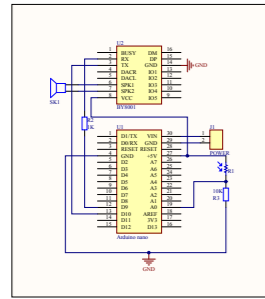

### PCB BOARD MAKING

The circuit diagram of the Arduino kit was redesigned to be able to produce as a PCB board. So it's easier to be assembled.



### ASSEMBLE

The Arduino kit was fixed on a piece of wood. Then it was connected with the "shell" s by two bamboo sticks.



#### QUICK TEST

A bamboo audio device had finished. Then I made a quick test to get to know if it's workable.



# Story recording and editing

## SOUND FILE

I had collected five stories of five bamboo articles. Stories were told by senior people, each story was edited around 30-40 seconds.

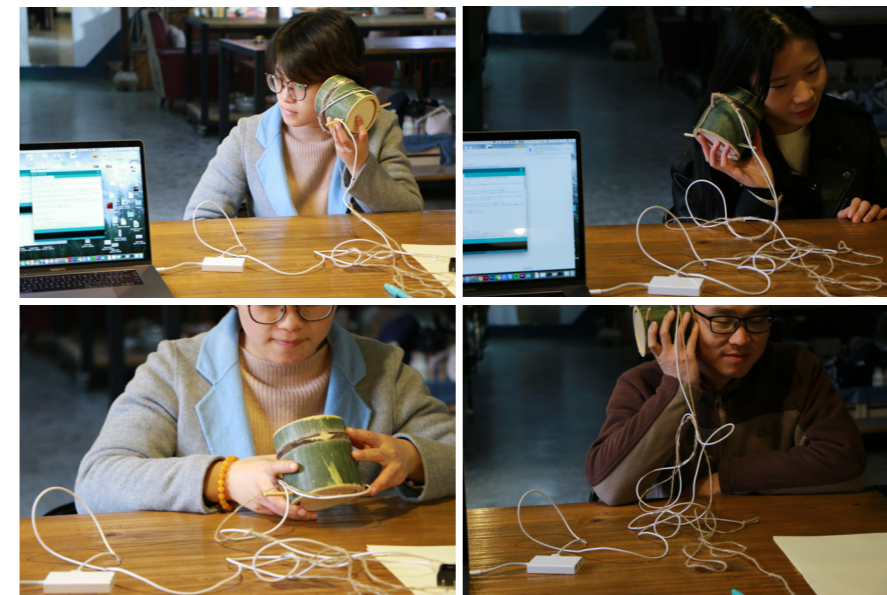

## TUNE

I had a quick test to get to know the appropriate audio volume for users.

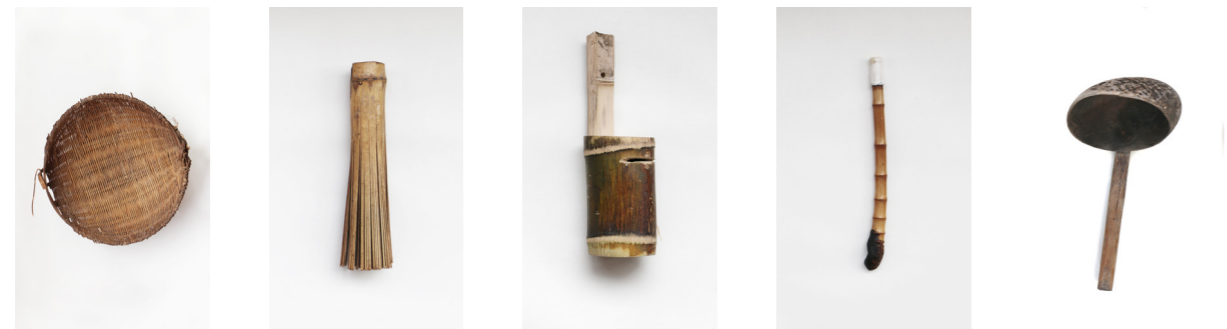

竹箩

刷帚

竹储蓄罐

竹根烟斗

木勺

BAMBOO BASKETS

BAMBOO BRUSH

BAMBOO MONEY-BOX

BAMBOROOT PIPE

BAMBOO SCOOP



## EXTRACT

For each piece of bamboo article, I extracted one representative sentence from the corresponding story, made it as a hint to inspire visitor's curiosity.

# Result

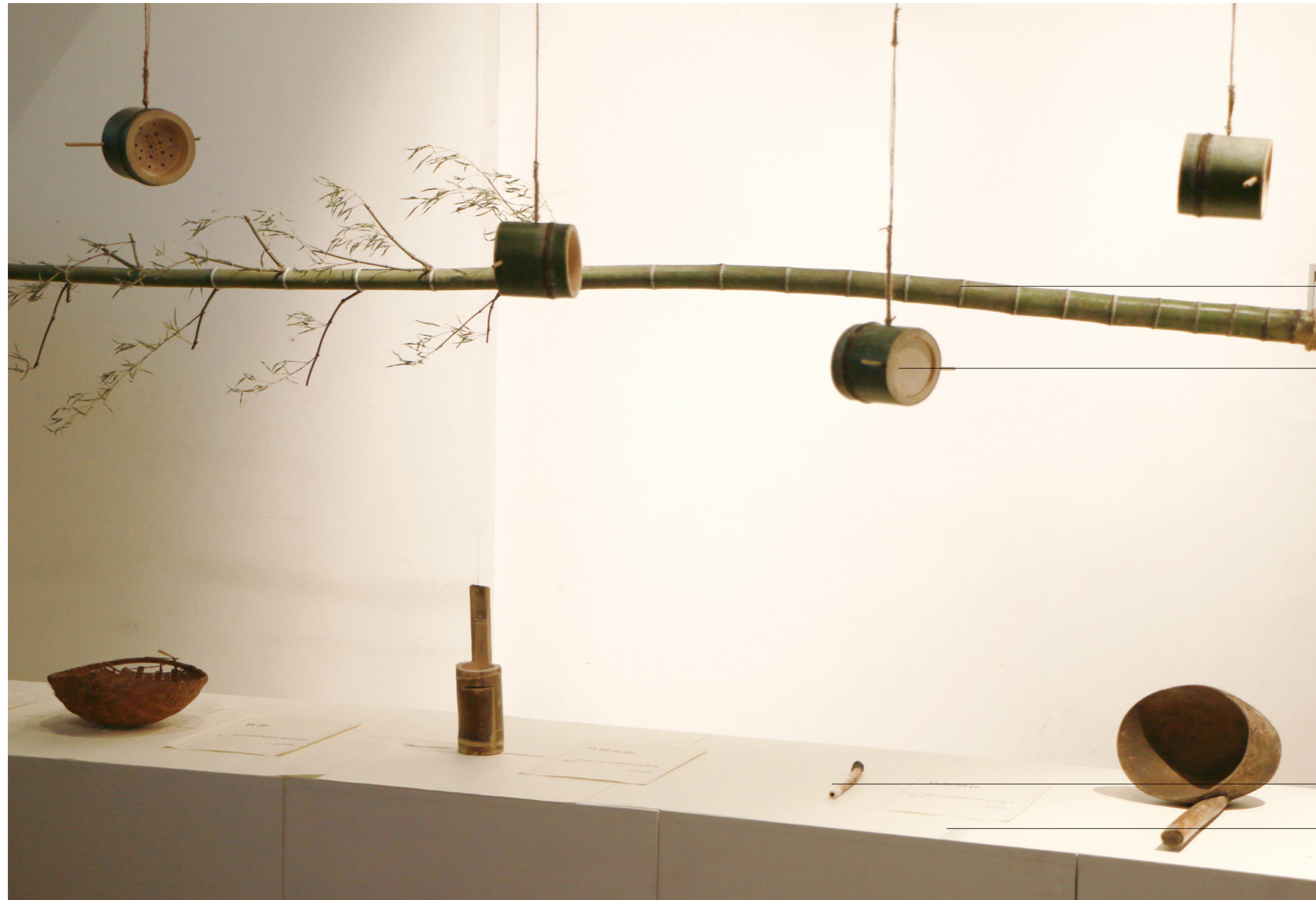

RAW BAMBOO

BAMBOO AUDIO DEVICE

THE BAMBOO ARTICLE

"HINT"

POSTER



TABLE LAYOUT





## WHISPER

The final result of this project -- an exhibit named WHISPER, it gives visitors a new kind of visiting experience.

Visitors get to know the knowledge of the bamboo article by listening the story told by a local senior citizen.

Five pieces of bamboo audio devices keep making buzz ---- low audio volume of people speaking, which draw visitors' attention. When visitors get closer and thus they get clear and louder volume to listen to the story.

# Feedback & Impact



TEXT READING



FACIAL RESPONSE



INTERACTION WITH BAMBOO ARTICLES OR TEXT WHILE LISTENING THE STORY



## MEMORIES EVOKING

Some visitors started to talk to each other.  
The memories about the bamboo articles when they were children, living together with their grandparents.



## POSITIVE FEEDBACKS

Nearly every visitor likes this exhibit and they are looking forward to seeing it in the museum.

" This exhibit is different from other exhibitions."

"Some of the bamboo articles I have never seen before, it's lovely to know what it is by hearing a story. The experience is very heartwarming."

"The exhibit is too small, I want to see more."

## NAGITIVE FEEDBACKS

The audio interaction part of this exhibit are obvious only when there are very few visitors,

The effect of audio interaction is decreasing when people get more, people focus on hearing the stories.

People's attention was attracted by stories soon.

"I notice the audio interaction, it's lovely and sensitive, but what attracted me most is the story itself. "

# Design possibility

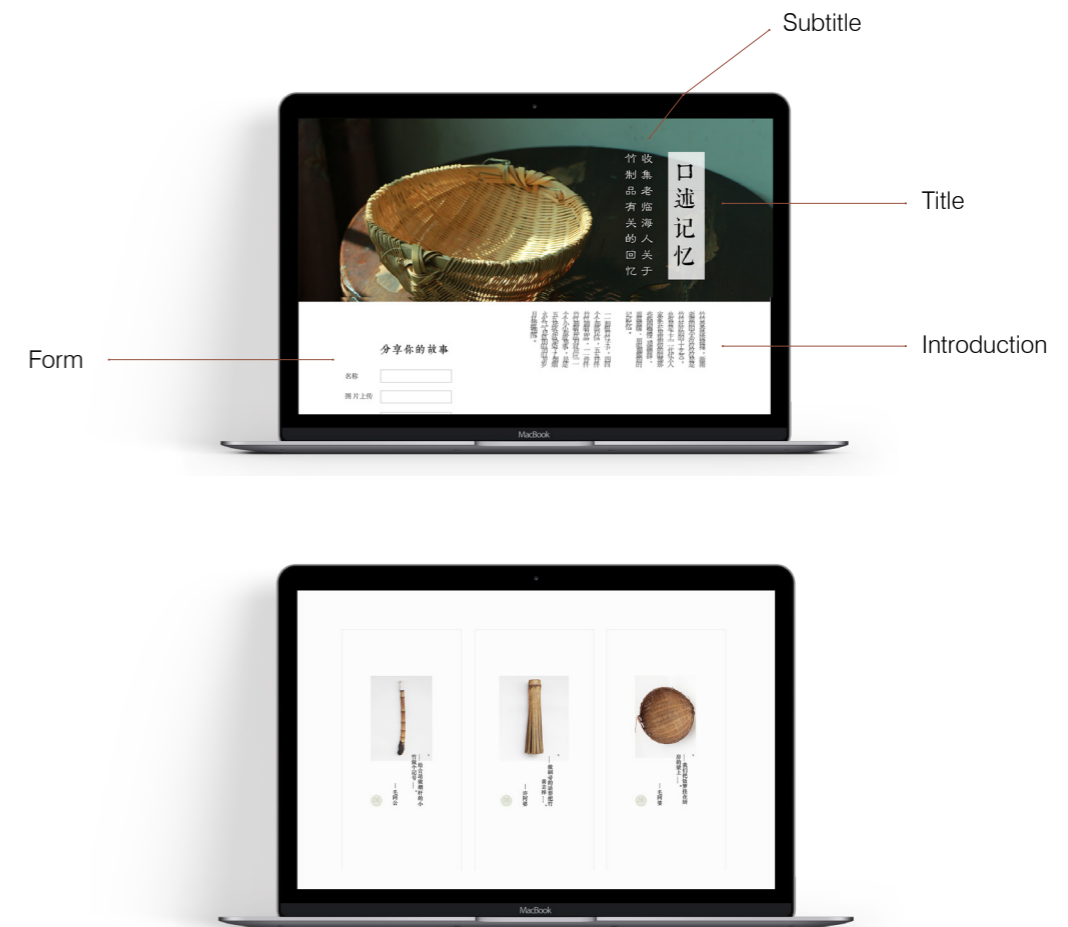

Open on  
26th DEC

End on  
31st MARCH

## LONG IMPACT

People get a touch after visiting the exhibit, however, the exhibition will last for three months, how to make the impact longer?

A concept of memory collection website appears It's an online platform, for the people to preserve and share their memories and personal story there.

# Reflection

Through the collaboration with MAY Studio for the exhibition of LOCAL CULTURE, I'm responsible to organize the bamboo craft exhibit, meanwhile, I assisted to arrange other types of craft exhibits. and make a part of graphic design work.

It's a meaningful experience of collaboration, I have my project tested in a real situation and get feedback instantly to know the shortcoming soon.

## NEXT.....

My collaborator MAY STUDIO is interested in the concept of reserve and transmit the local culture to young people by the way of word of mouth. Base on this idea, we plan to build an online story museum, by collecting the sound we hear in different situations in this city, to reserve the beauty of this city.





# Reference

[1] Understanding traditional Chinese arts to preserve them for the future[2016]  
Available from: <http://www.neehao.co.uk/2016/08/understanding-traditional-chinese-arts-to-preserve-them-for-the-future-1/>

[2] Traditional craftsmanship  
Available from: <https://ich.unesco.org/en/traditional-craftsmanship-00057>

[3] Convention for the Safeguarding of the Intangible Cultural Heritage  
Available from: <https://ich.unesco.org/en/convention>

[4] Let more citizens realize the culture and natural heritage in Linhai  
让更多市民了解临海的文化与自然遗产  
Available from: [http://www.linhai.gov.cn/art/2017/6/12/art\\_3\\_191614.html](http://www.linhai.gov.cn/art/2017/6/12/art_3_191614.html)

[5] Be patient, listen to the traditional handcraft  
急不得，聆听民艺的声音  
Available from: [http://www.360doc.com/content/15/1203/15/2369606\\_517652965.shtml](http://www.360doc.com/content/15/1203/15/2369606_517652965.shtml)

[6] Why do we choose to do the traditional craftsmanship  
为什么要做民艺这件很难的事情  
Available from: <http://www.yogeev.com/article/71598.html>

[7] 「日本民艺之父」柳宗悦  
Available from: <https://site.douban.com/113806/widget/notes/14811508/note/340703778/>

[img] <https://www.douban.com/event/26709922/>

[img] [https://mp.weixin.qq.com/s?\\_\\_biz=MzA4NzAyMTgyNg==&mid=2650146039&idx=ticket=WtGMT1uyQ5B0XHcmCjKLE3P%2BsI0OA4WtmW3n0ULePUsfHcj3NikhW%2FnEx%2FTi6Of#rd](https://mp.weixin.qq.com/s?__biz=MzA4NzAyMTgyNg==&mid=2650146039&idx=ticket=WtGMT1uyQ5B0XHcmCjKLE3P%2BsI0OA4WtmW3n0ULePUsfHcj3NikhW%2FnEx%2FTi6Of#rd)

[img] [https://www.google.no/search?q=hand+fog&source=lnms&tbm=isch&sa=X&ved=0ahUKEwjXtrzfxYbYAhUB-6QKHct6BU\\_sQ\\_AUICigB&biw=1680&bih=932#imgrc=t9EjXIX2\\_7TvzM](https://www.google.no/search?q=hand+fog&source=lnms&tbm=isch&sa=X&ved=0ahUKEwjXtrzfxYbYAhUB-6QKHct6BU_sQ_AUICigB&biw=1680&bih=932#imgrc=t9EjXIX2_7TvzM)

[img] <https://www.pinterest.com/pin/420594052692249930/>

[img] <https://www.pinterest.com/pin/420594052692249917/>

[img] <https://www.pinterest.com/pin/4>

[img] <https://www.pinterest.com/pin/420594052692218307/>

[img] <https://www.pinterest.com/pin/420594052692218307/20594052691967501/>

[img] <https://www.pinterest.com/pin/420594052692206900/>

[img] <http://kaiping.69ys.com/predetail/60176>

[img] <https://radiopaedia.org/images/25829>

[img] [http://img.mp.itc.cn/upload/20170512/c097a002d3954427831bb357519ae490\\_th.jpg](http://img.mp.itc.cn/upload/20170512/c097a002d3954427831bb357519ae490_th.jpg)

[img] [http://img.mp.itc.cn/upload/20170512/71821646668f4d0aa11b7442e74d1678\\_th.jpg](http://img.mp.itc.cn/upload/20170512/71821646668f4d0aa11b7442e74d1678_th.jpg)

[img] <http://www.chinadaily.com.cn/dfpd/jingji/attachement/>

[jpg/site1/20131206/eca86bda384c140b77c105.jpg](http://www.chinadaily.com.cn/dfpd/jingji/attachement/jpg/site1/20131206/eca86bda384c140b77c105.jpg)

[img] <https://encrypted-tbn0.gstatic.com/images?q=tbn:ANd9GcSiHaqiOks3QmfvulAS-Fr96gImNBg9dY2kaOTd-LNpHhf-5pqejg>

[img] [https://encrypted-tbn0.gstatic.com/images?q=tbn:ANd9GcTdYxwmVYo2I6VvCR7Tio4RfamxLvoJ6IhfYR6xSN0b492\\_vhJZ](https://encrypted-tbn0.gstatic.com/images?q=tbn:ANd9GcTdYxwmVYo2I6VvCR7Tio4RfamxLvoJ6IhfYR6xSN0b492_vhJZ)

[img] <http://static.chinacaipu.com/d/file/menu/>

[jiankangyinshi/2017-03-28/39e94a0bffb4fa4d8f4f0616ce6b87ce.jpg](http://static.chinacaipu.com/d/file/menu/jiankangyinshi/2017-03-28/39e94a0bffb4fa4d8f4f0616ce6b87ce.jpg)

jpg