

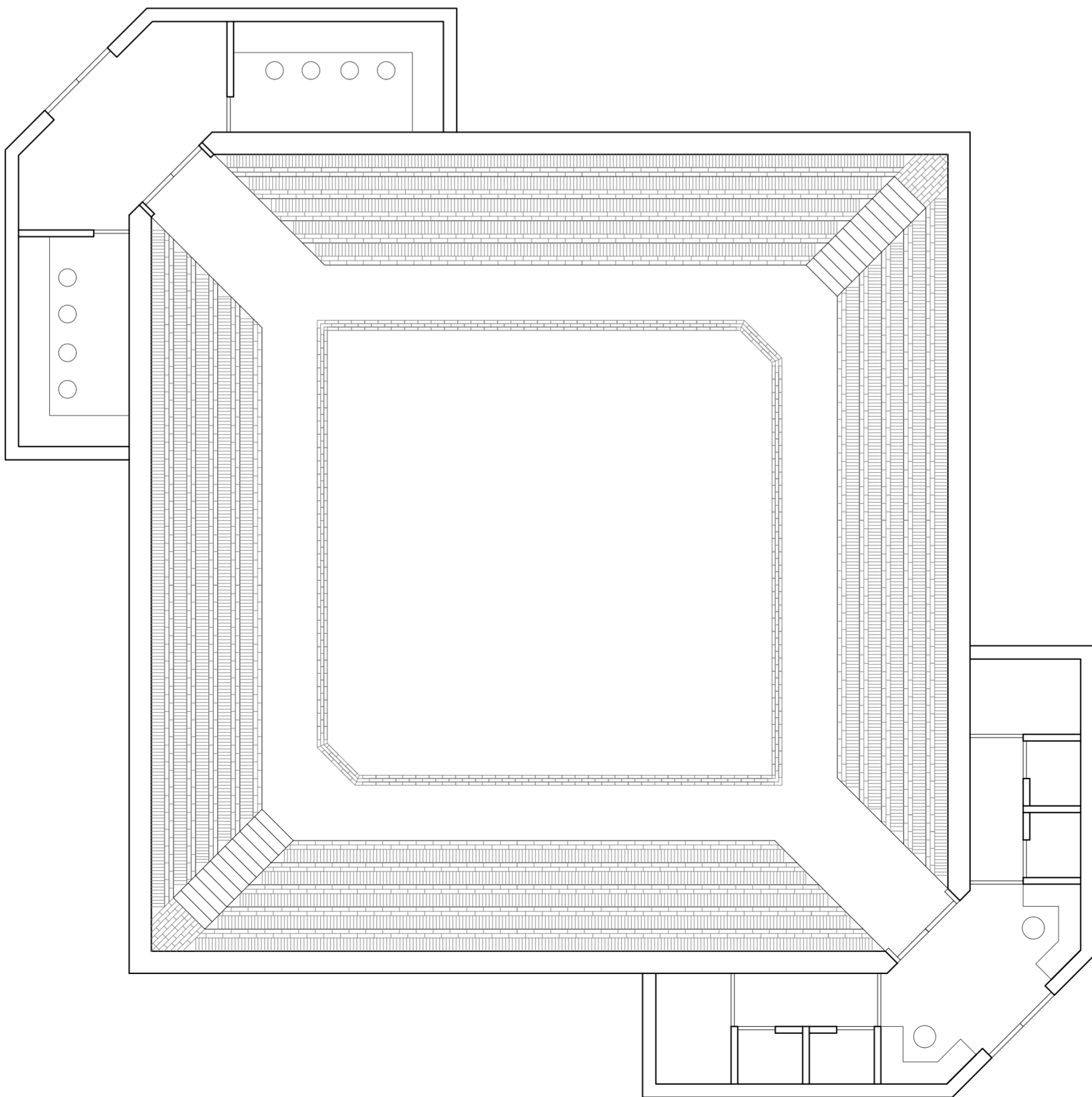

 Theatre plan 1
Scale 1:100



 Theatre plan 2
Scale 1:100

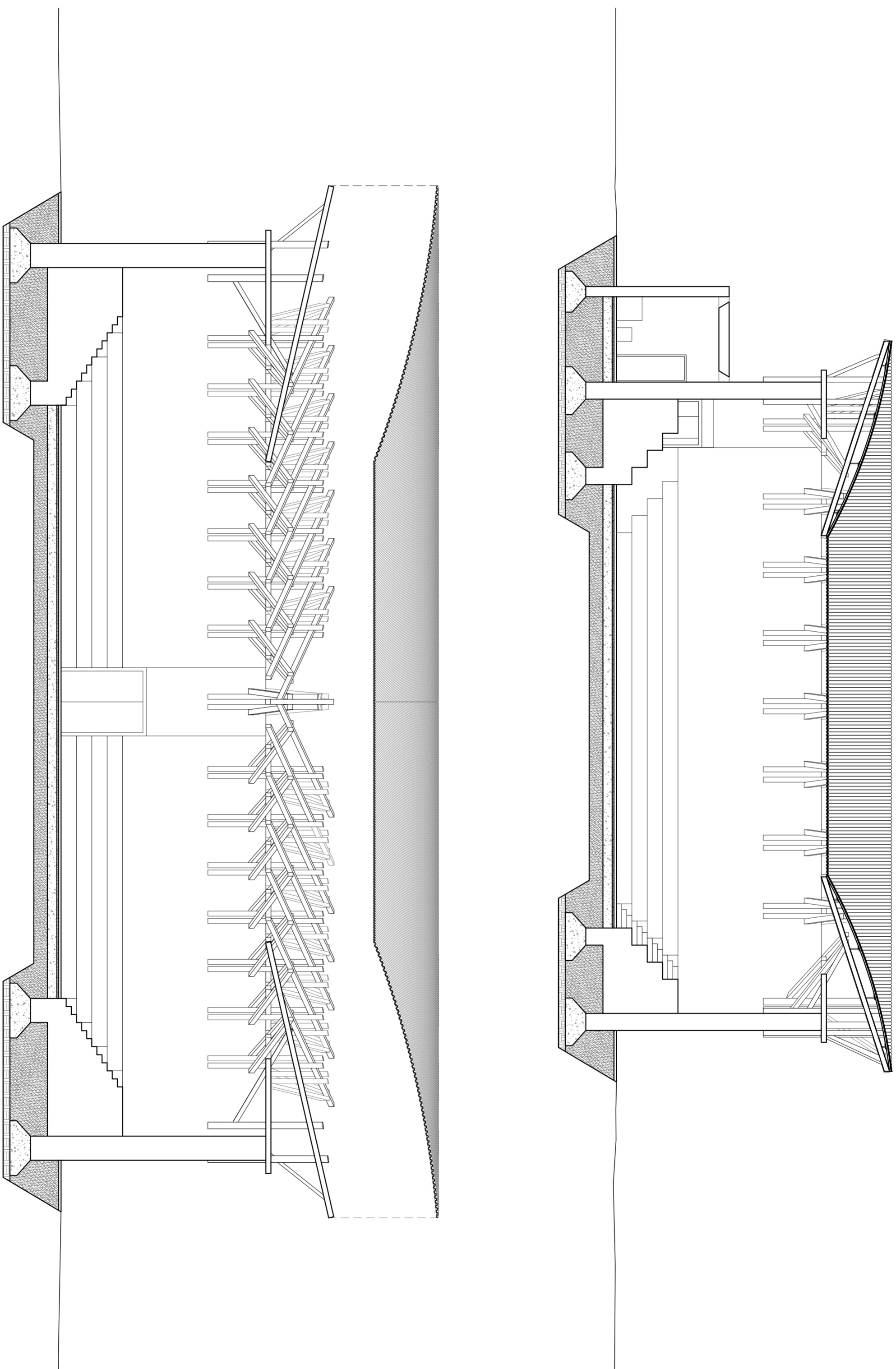

Theatre section
Scale 1:100

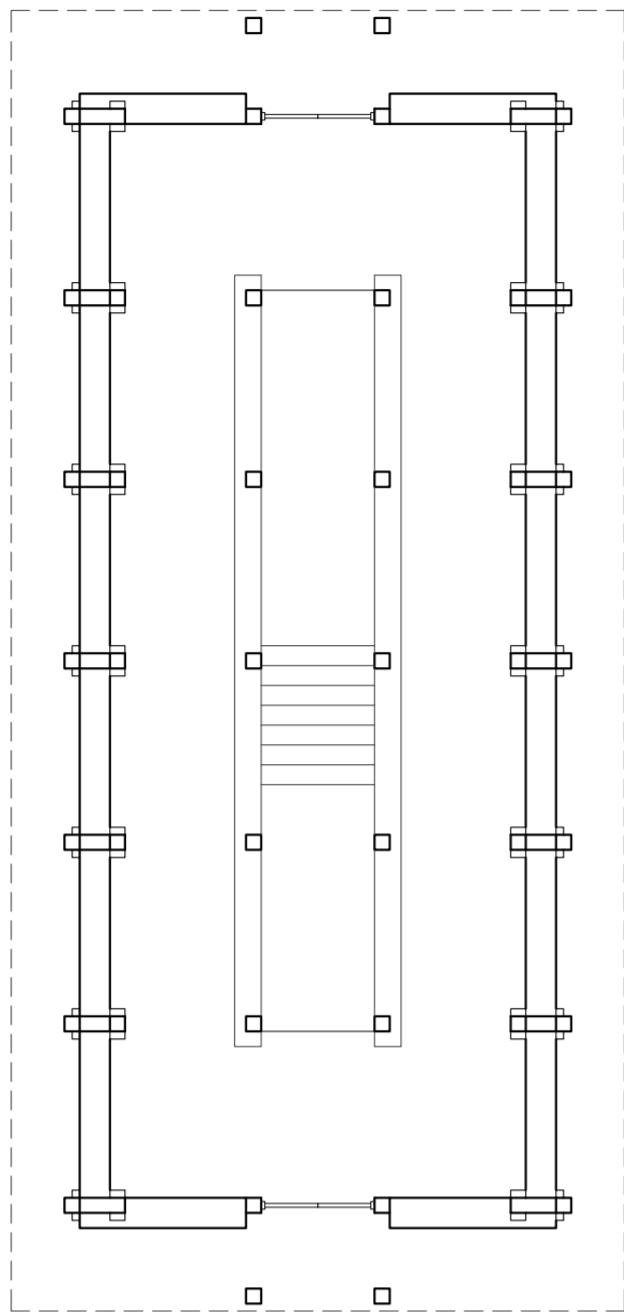

1F

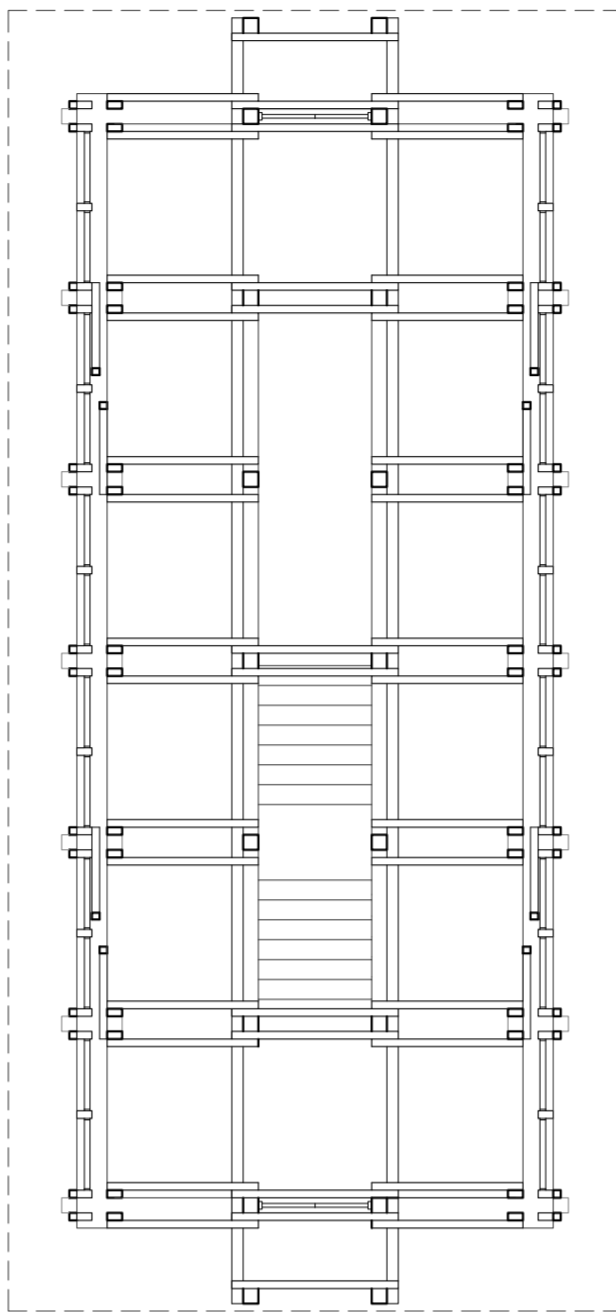

1F Beam

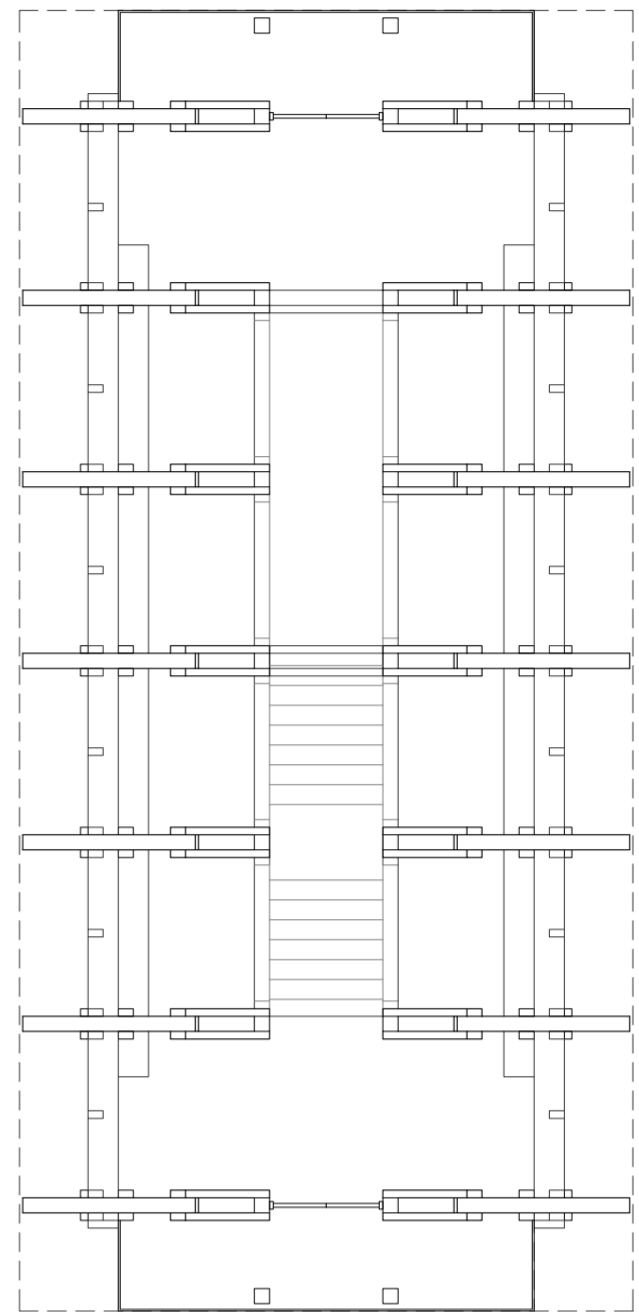

2F Beam



Library plans
Scale 1:100

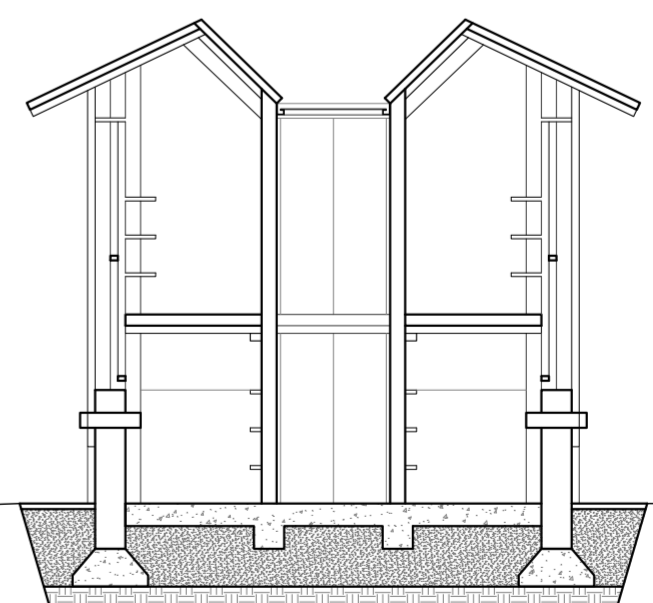
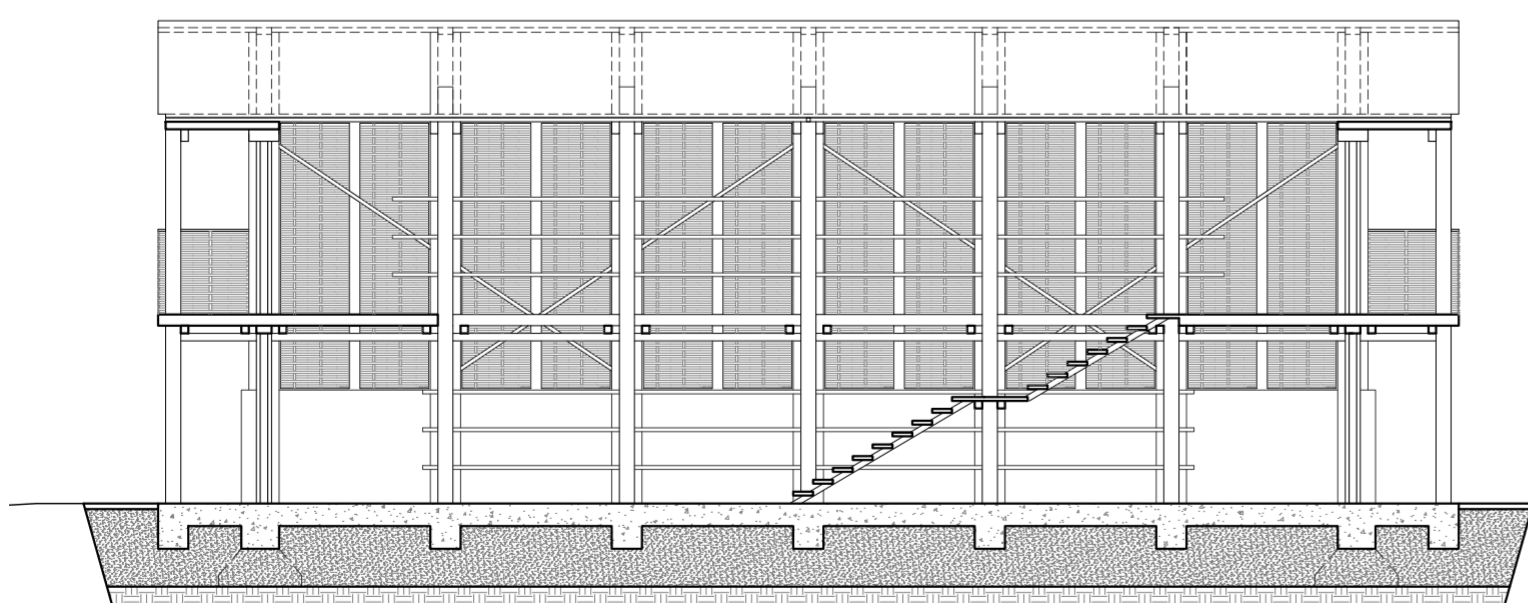

Library section
Scale 1:100

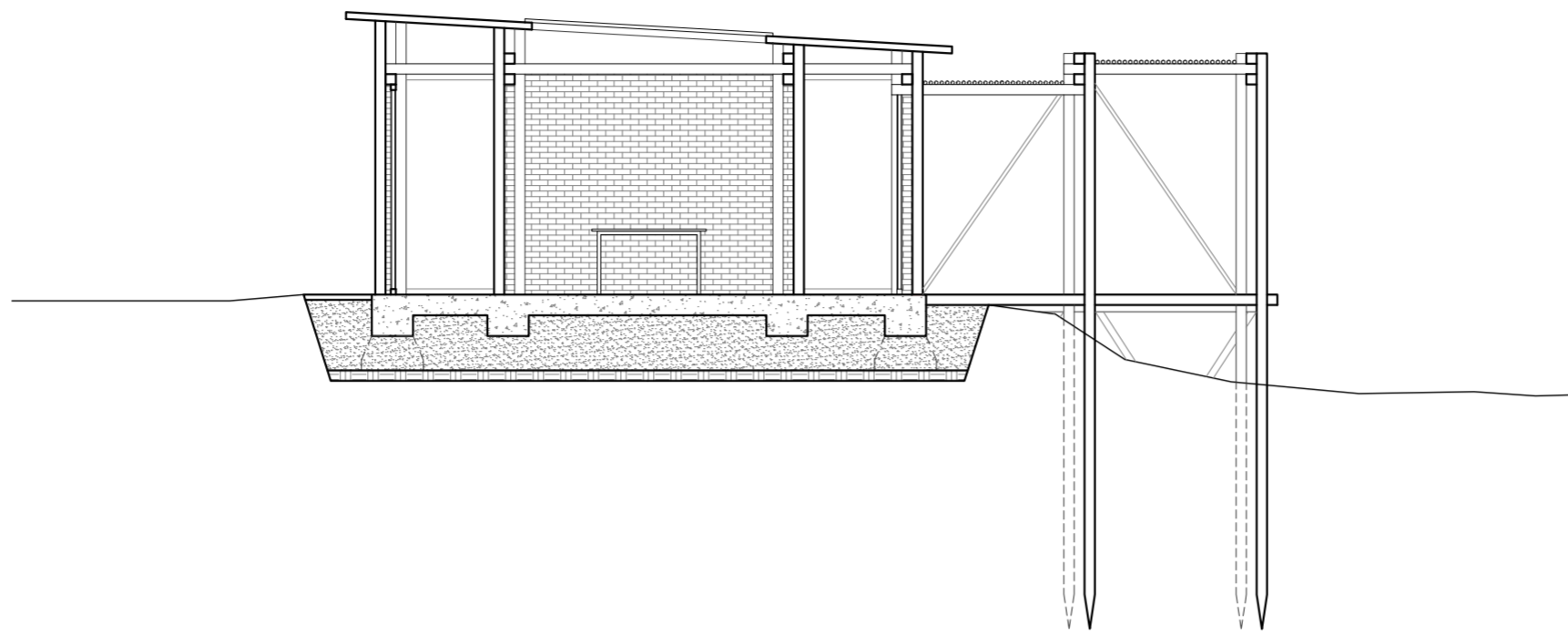

Office and Info centre section
Scale 1:100

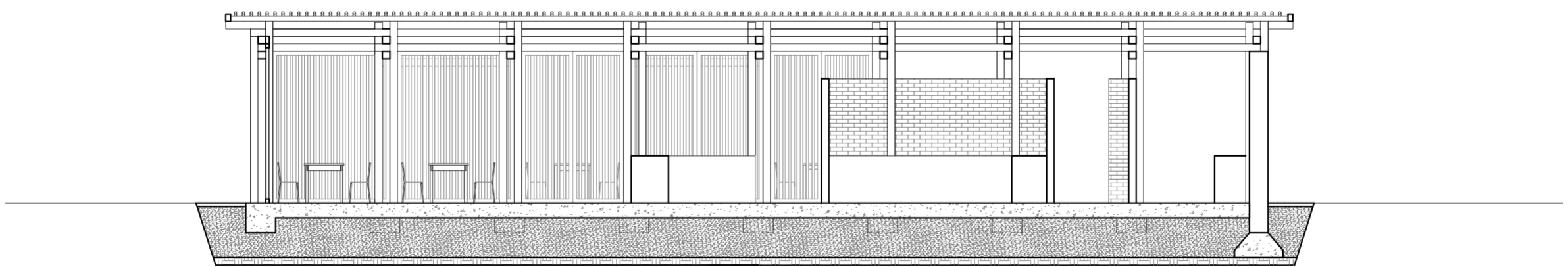
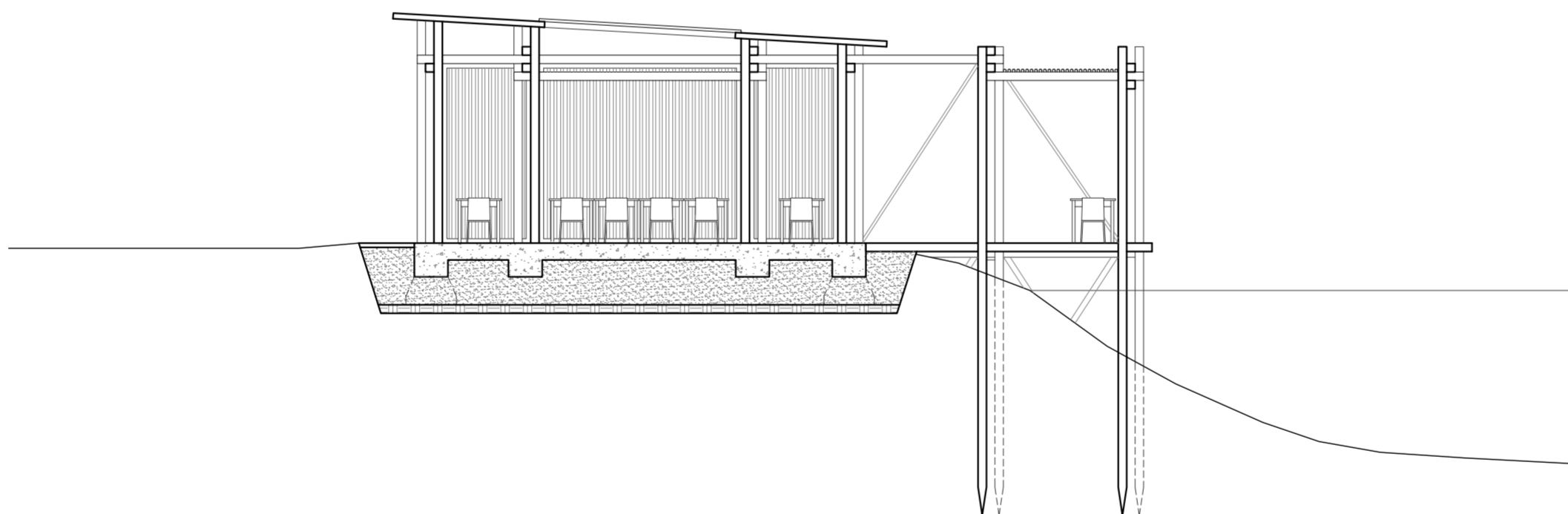
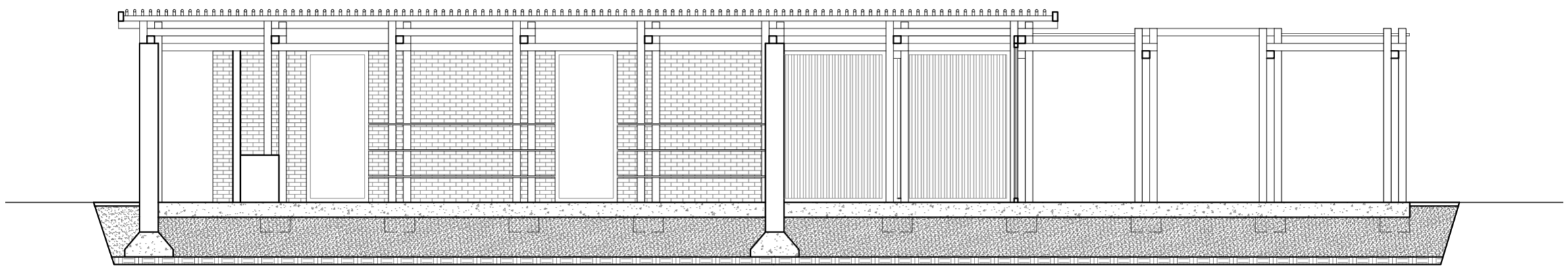

Cafe section
Scale 1:100

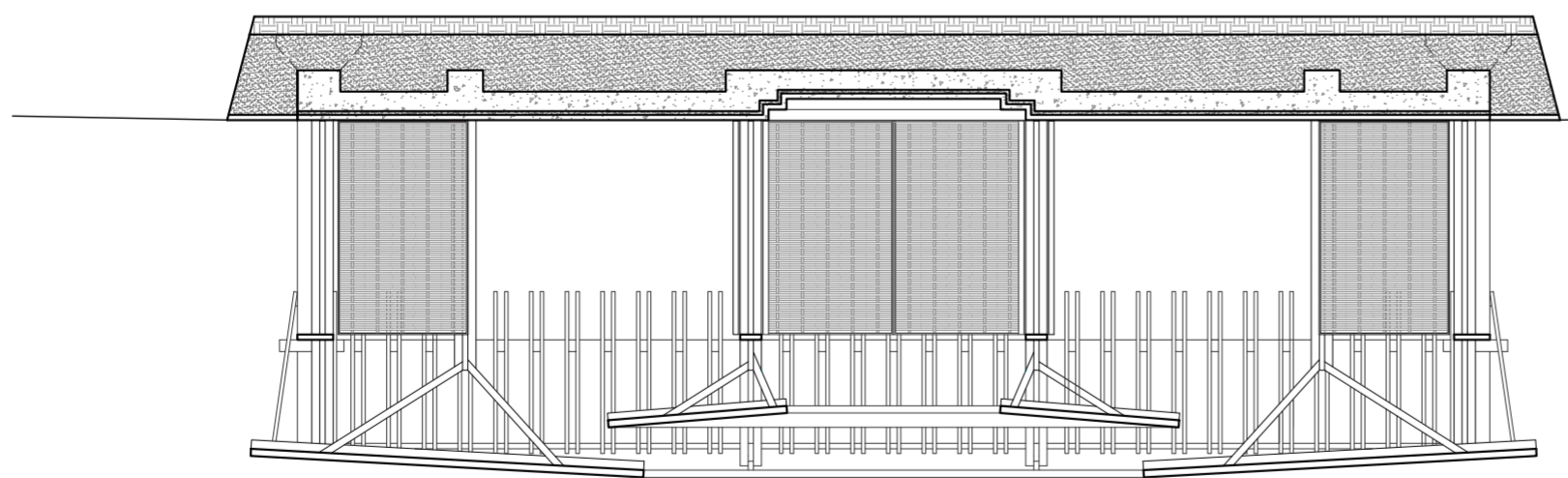
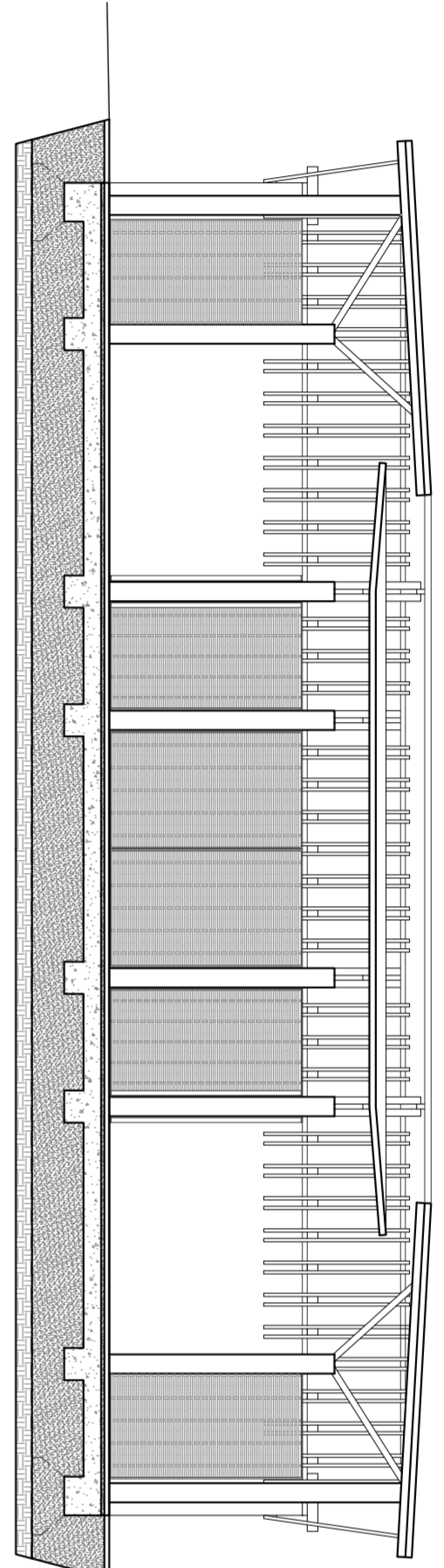
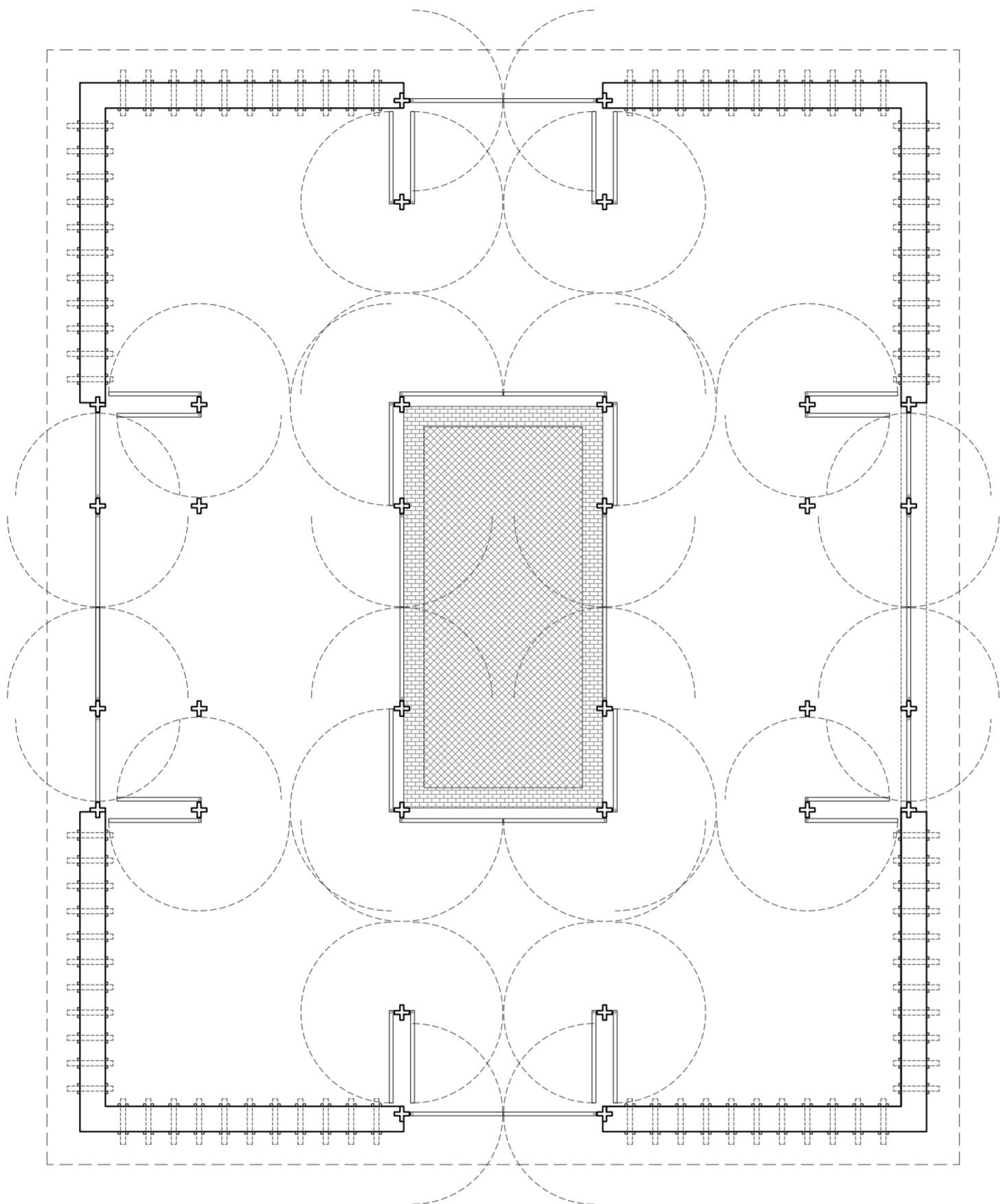

Multi-purpose hall
Scale 1:100

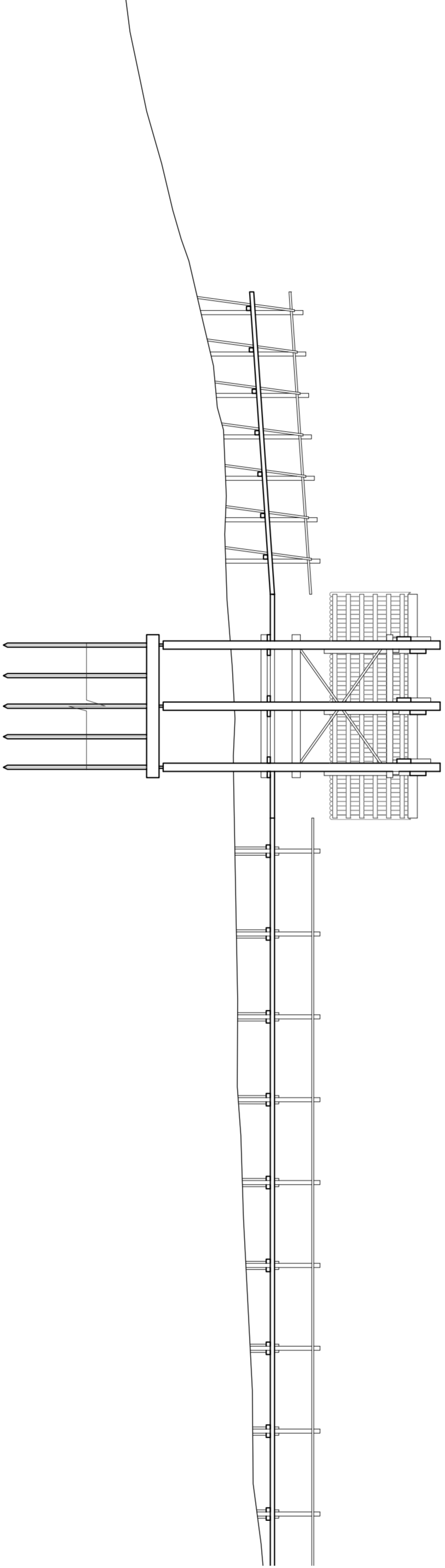

Cover
Scale 1:100

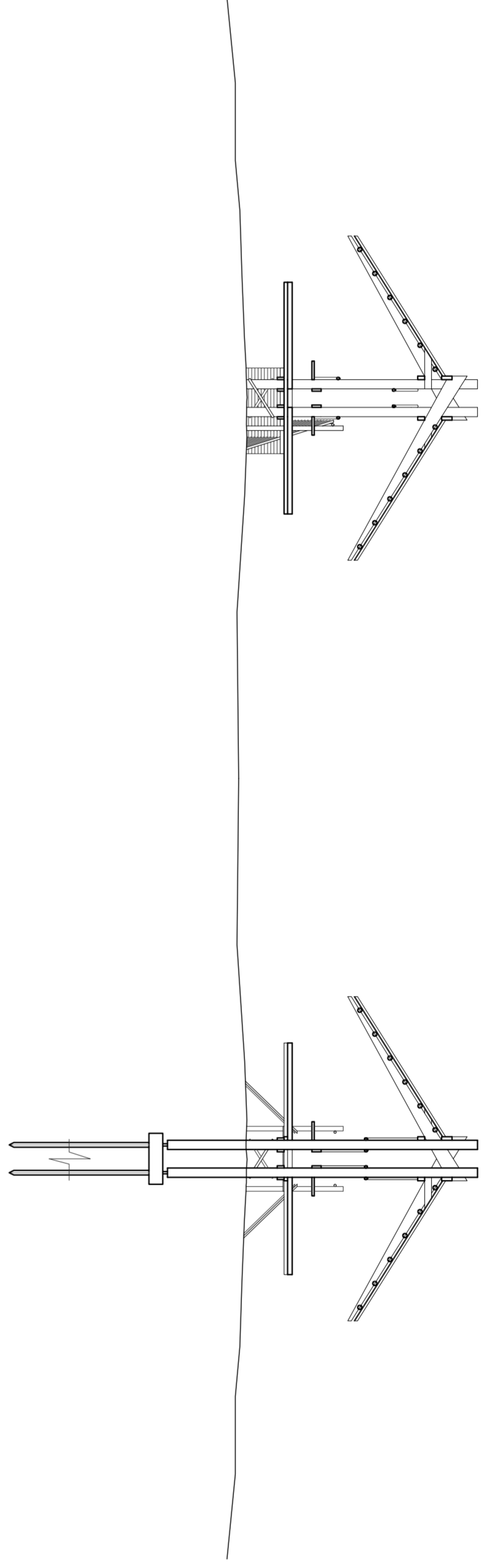

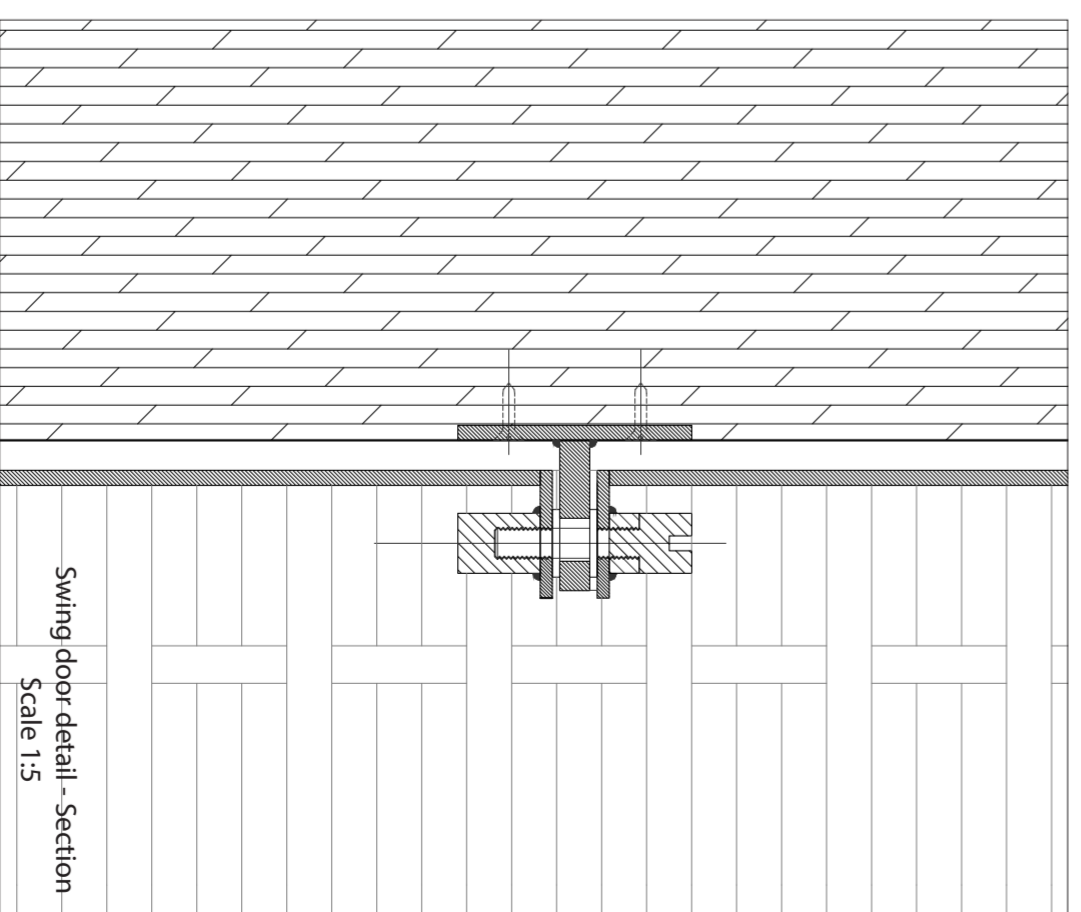
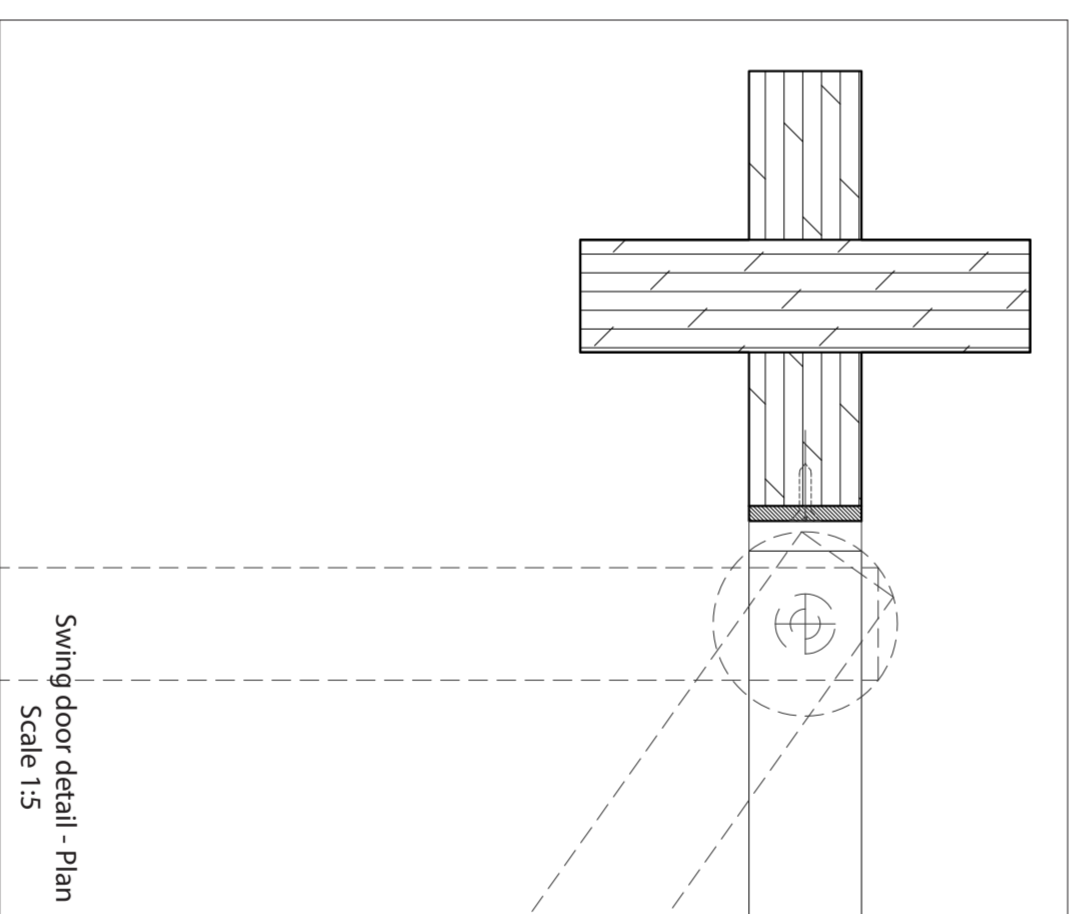
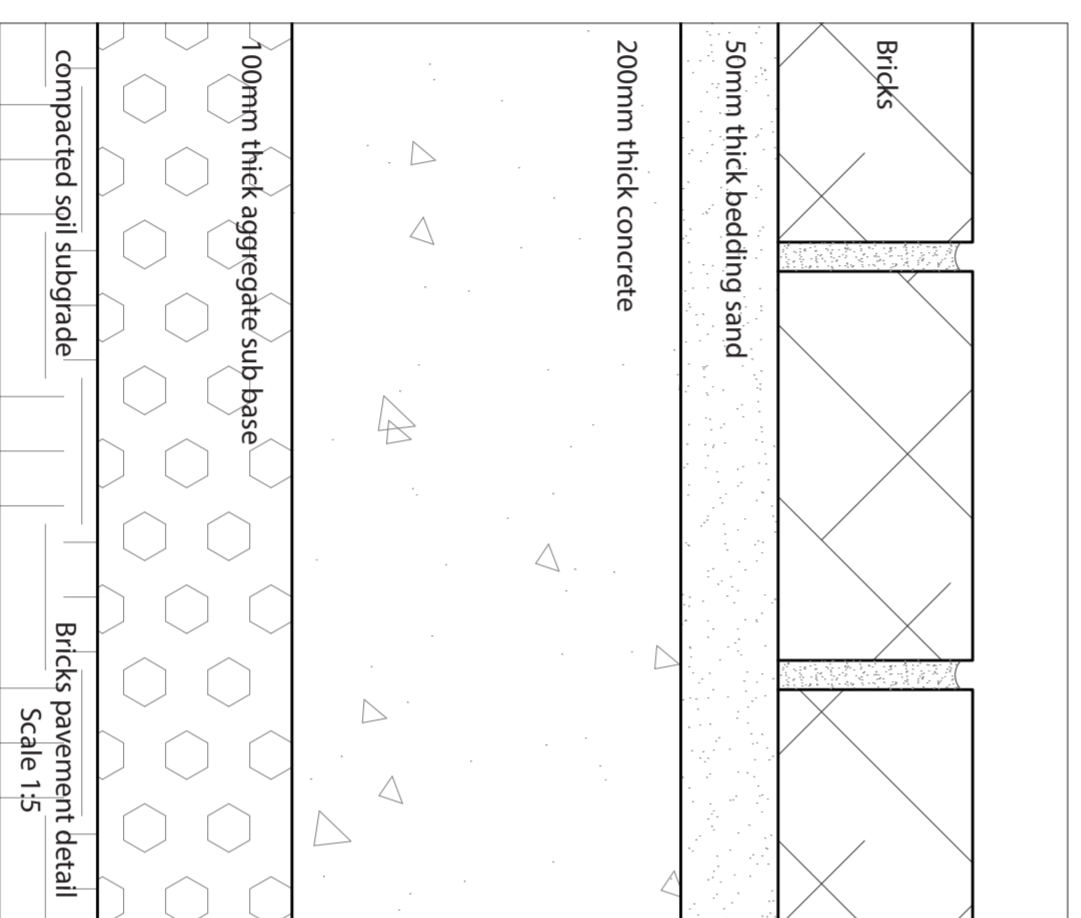
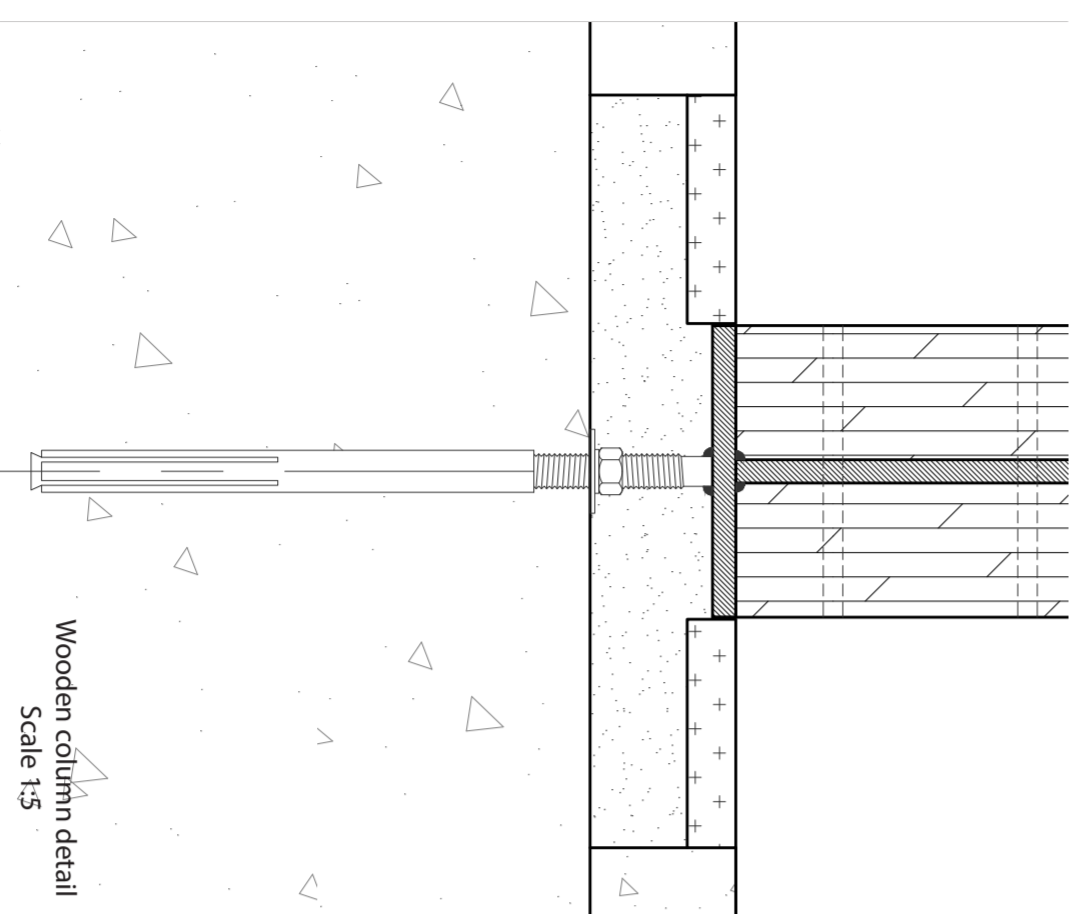
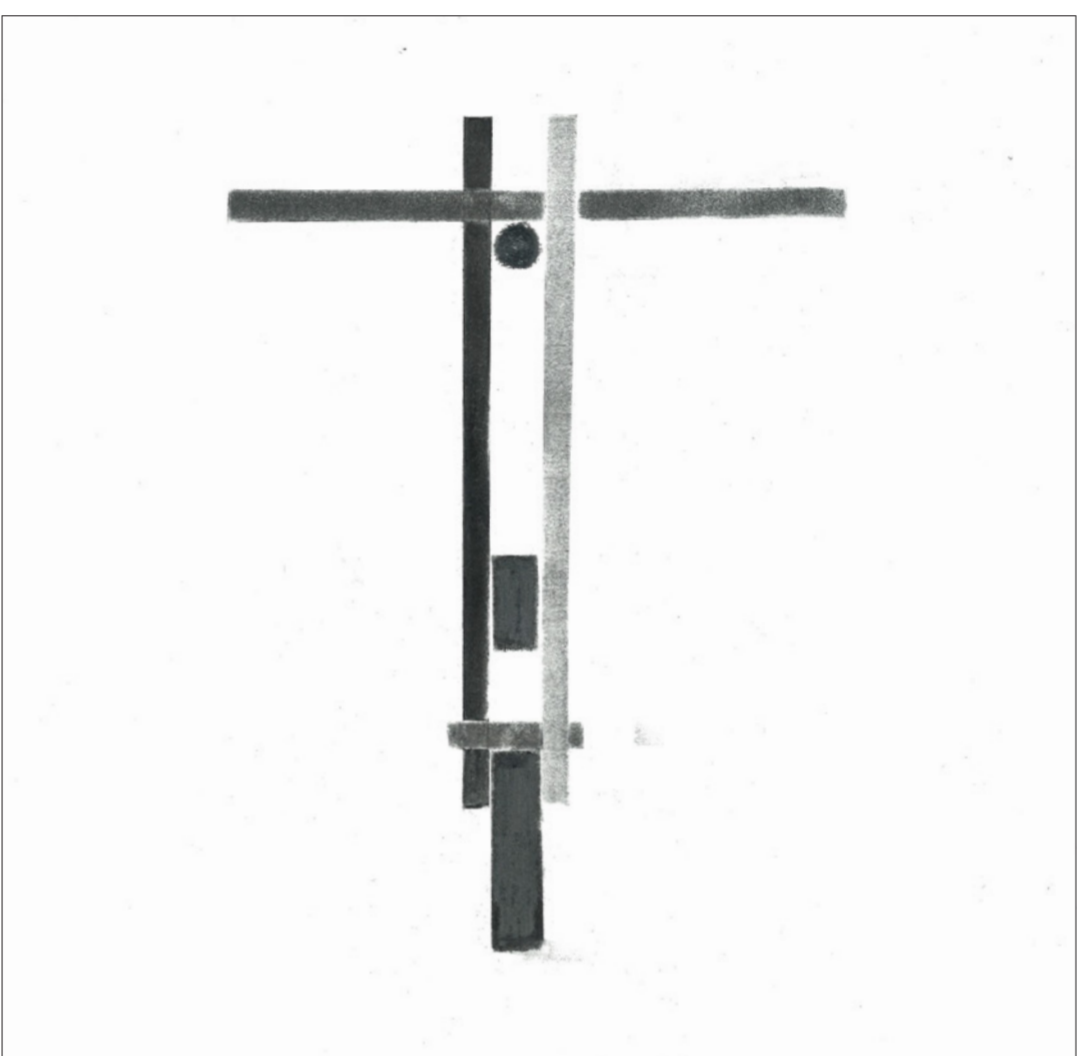

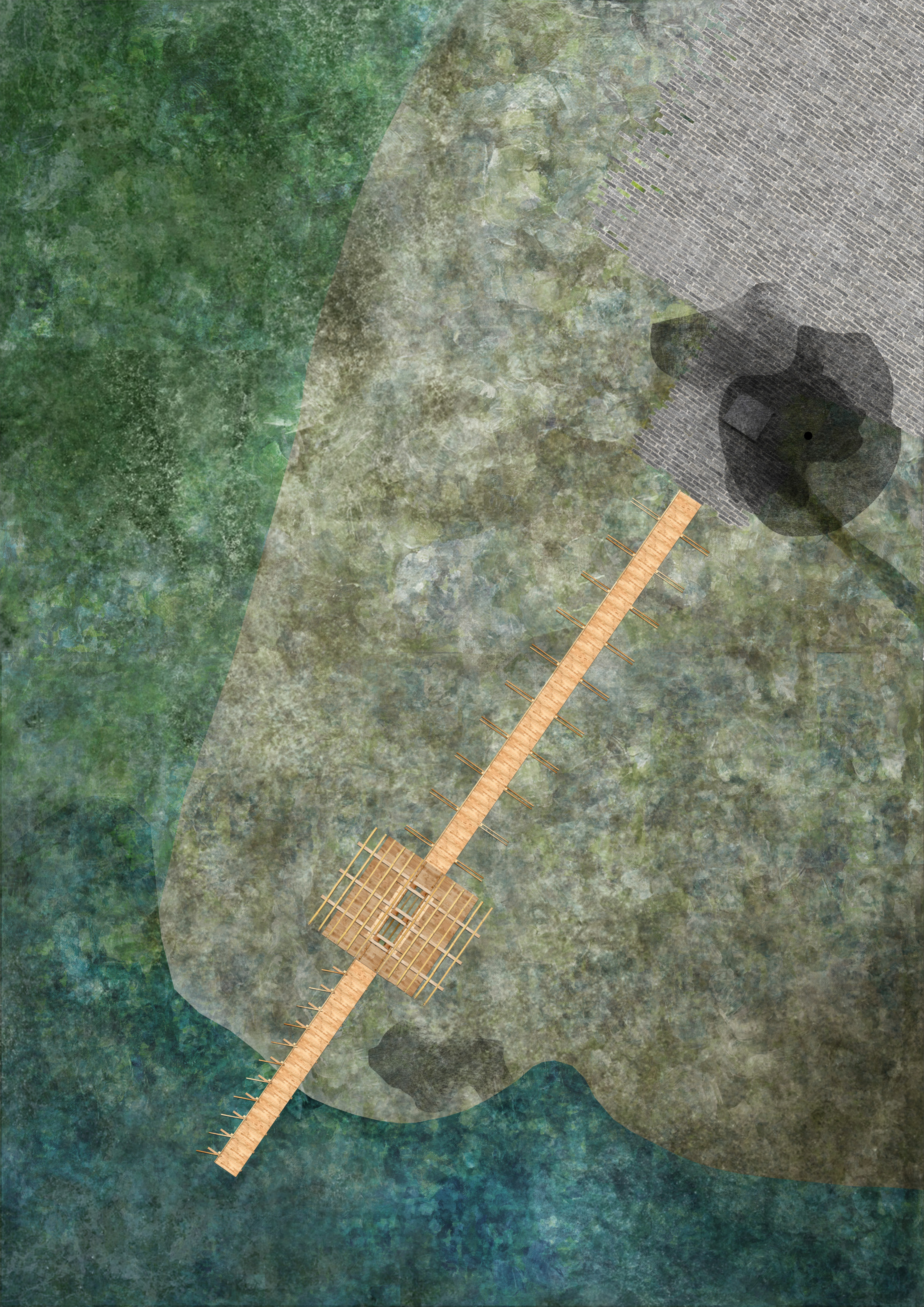

亭

(ting⁴)

《釋名·釋宮室》：亭，停也，亦人所停集也。

Pavilion

P A V I L I O N

亭中，
我們乘涼。
在柔光下靜心享受，
在微風下遠望景色，
葉子簌簌，
何其坦然。

To stay in the pavilion
Enjoying peacefulness
with the gentle sunlight
Overlooking the view with the breeze
Leaves are rustling
Calm

笙堂

(sang¹tong⁴)

《廣韻·下平聲·庚·生》笙：樂器也，禮記女媧造笙簧。
堂：殿也。从土尚聲。

Song . Hall

T H E A T R E

感官來自四方，
春，碧綠，
夏，淅瀝，
秋，橘黃，
冬，稍稍，
演者於庭，欣賞。
友人於庭，交流。
如此熱鬧。

Senses from four directions to the Hall
Spring, jade floods
Summer, rain patters
Autumn, amber enriches
Winter, wind blows
Performers in the hall, appreciation
Friends in the hall, communication
Lively

冊柵

(caak³saan³)

《論語注疏·述而》：《坊記》云然者，禮：夫人初至必書於冊。
《說文解字·木部》：柵：編樹木也。

Script . Lattice

L I B R A R Y

空間，
被柵包圍，
漏著幾段空隙，
人影隱約。
書冊，
架於支柱，
虛室生白，
陽光慷慨的瀉滿房間，和暖。

Spaces
Surrounded by the Lattice
In between the void
Vague silhouette
Books place on the shelves
Shelves Interlocked with columns
The room is filled with light, White
Light occupy the room generously, Warm

構堂

(gau³tong⁴)

《木部》構：蓋也。从木苒聲。杜林以為椽桷字。

Construct . Hall

M U L T I - P U R P O S E
H A L L

青灰色的圍牆內
擁有各種空間，
被簾分隔，
讓我們穿梭，
層層遞進，
在空間中建構
虛，
傳承文化，
活演建築。

Spaces surrounded by the walls
Slightly green, Slightly grey
Divided by the screen
Travelling in between
Step by step with layers
Constructing in spaces
Virtual
Inherit culture
Evolve architecture

工棚

(gung¹ paang⁴)

《工部》工：巧飾也。象人有規架也。
《廣韻·下平聲·庚·彭》棚：棧也，閣也。

Work . Shed

OFFICE AND INFO
CENTRE

從牆壁鑿開窗戶、門，
此為室。
坐下，
提筆書寫，
孕，字。
育，文化。

The door and windows are cut out from the walls
to form a room
Take a seat
Lifting a pen
Breeding words
Cultivating culture

井棚

(zeng² paang⁴)

《淮南子·齊俗訓》：鑿井而飲，耕田而食。

Waterwell . Shed

C A F E

牆
是一種依靠
有孔
光柔灑地穿梭
平整
光線被調暗，
活動被隔絕
堅固並安全地保護

Walls
is a type of reliance
With holes
Light gently go through
Neat and uniform
Intended to dim the light
Activities got isolated
Firm and secure to protect

傘

(saan³)

《廣韻·上聲·早·散》傘：傘蓋。

Cover

C O V E R

咯噠的踏上木橋，
「小橋流水人家」
扶著竹枝，
沿著樹影，
欣賞著湖水澹澹
從磚牆走到庭園，
遊走青壁到翠綠，
悠揚的下午。

Clacking of the bottom of the shoes on the wooden bridge
"The small bridge with the flowing water, dwellings of people"
Holding the bamboo
Following the shadow of trees
Appreciating the slow-moving water
From the brick wall to the garden
Walk around the pale greyish green to different shades of emerald
A melodious afternoon

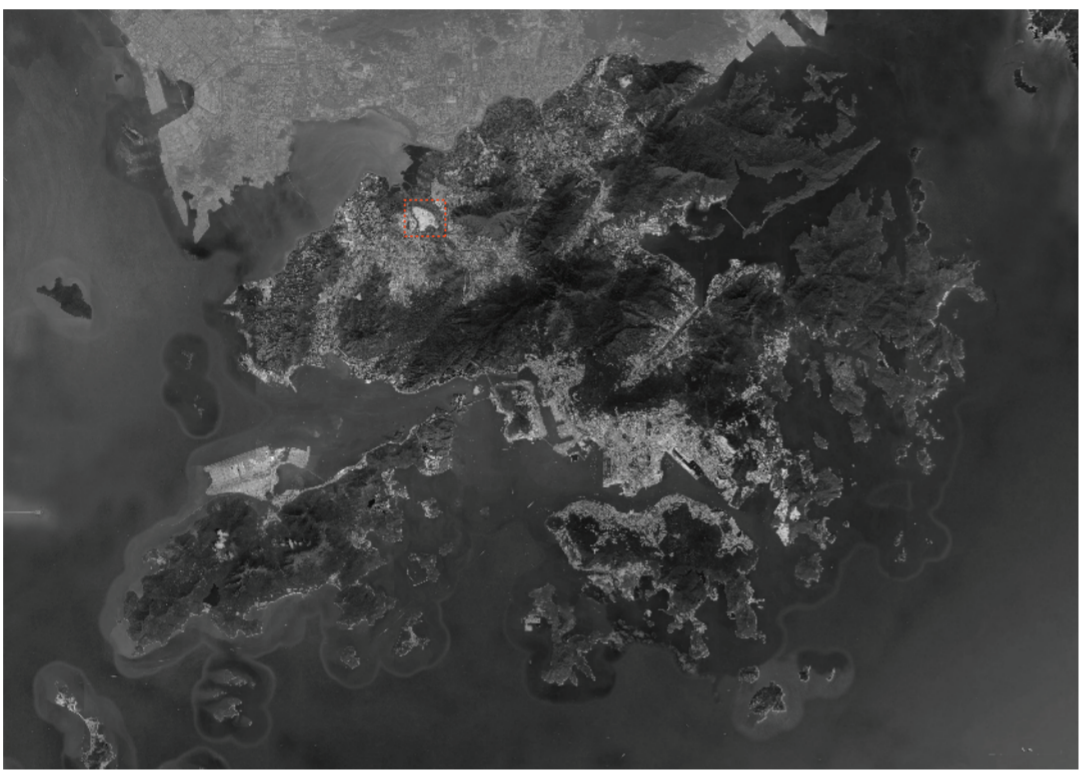
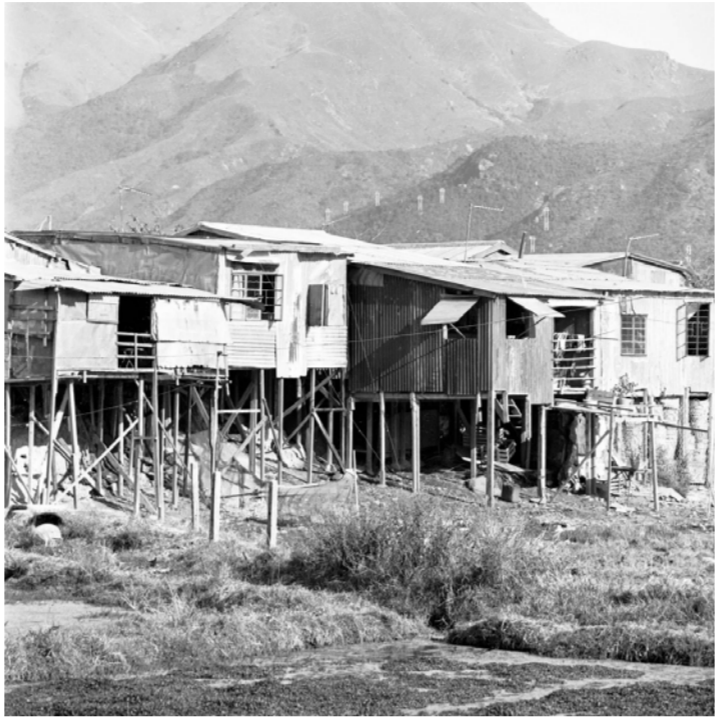

亭 闢 築 窗 架 構
 亶 圍 籬 屋 柱 框
 問 園 宇 庭 棚 牆
 門 竹 家 廳 柵 磚
 聞 簾 室 建 橋 船



我們用部首來造字，有些是最原始的圖像。它們反映物料、結構甚至空間使用和次序，再結合次要的筆劃，形成字。

We use signs to form a character, some are the most primitive of pictograms. They represent materials, construction or even the use of space and order. With the combination of the secondary components, new characters are made.

在文字的構造中，我們講求對稱和軸心，然而維持字的平衡卻是控制首部與邊旁空間比例的重要一環。在大小相同的字框當中，部首會被邊旁影響，比例亦因此被改變。

Symmetry and axis is found in the tectonic of the characters. Moreover, considering the spatial proportion of different components is crucial in keeping the balance of a character. The size of a sign is being affected by the components in the same text frame, therefore, the proportion of the same sign but in a different characters might change.



Door

Gate

Close



Build

Stand

Pillar

Shed

Lattice

Bridge

韋

《廣韻·上平聲·微·翰》關：守也，闕也，邊也。
To surround and encircle

青灰色的圍牆內擁有各種空間，
讓我們穿梭。
層層遞進，
喚起了歷史，
體驗了現在，
展望了將來。

Spaces surrounded by the walls
Slightly grey
Travelling in between
Step by step with layers
Recalling the past
Experiencing the present
Longing for the future

構

《木部·構·霽也。从木黃聲。柱林以為榑斲字。
Construct and form

以竹建屋，輕
以木建屋，穩
以磚建屋，實
相異物料的共存，成了空間
相異元素的配合，成了文字
在空間中建構文字
虛。
傳承文化，活潑建築。

Built by bamboo, light
Built by wood, steady
Built by brick, solid
Co-existence of dissimilar materials, establish spaces
Co-existence of different components, create words
Construct words in spaces
Virtual
Inherent culture
Evolve architecture