

AHO Diplom

“Galleri Oslo – a Project for a new Public Interior”

Åsmund Skeie

Files Archive

01 Plans

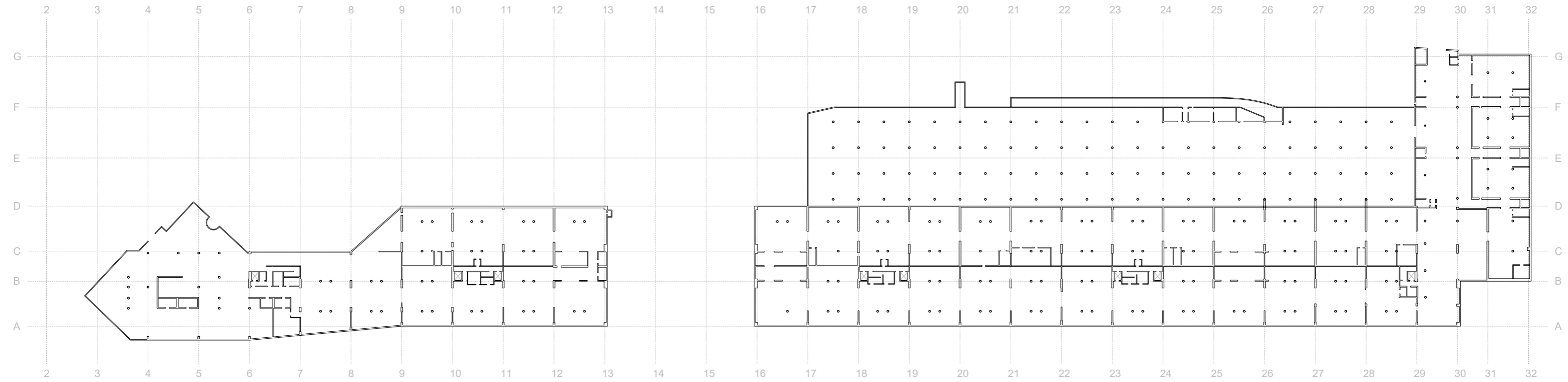

PLAN -1

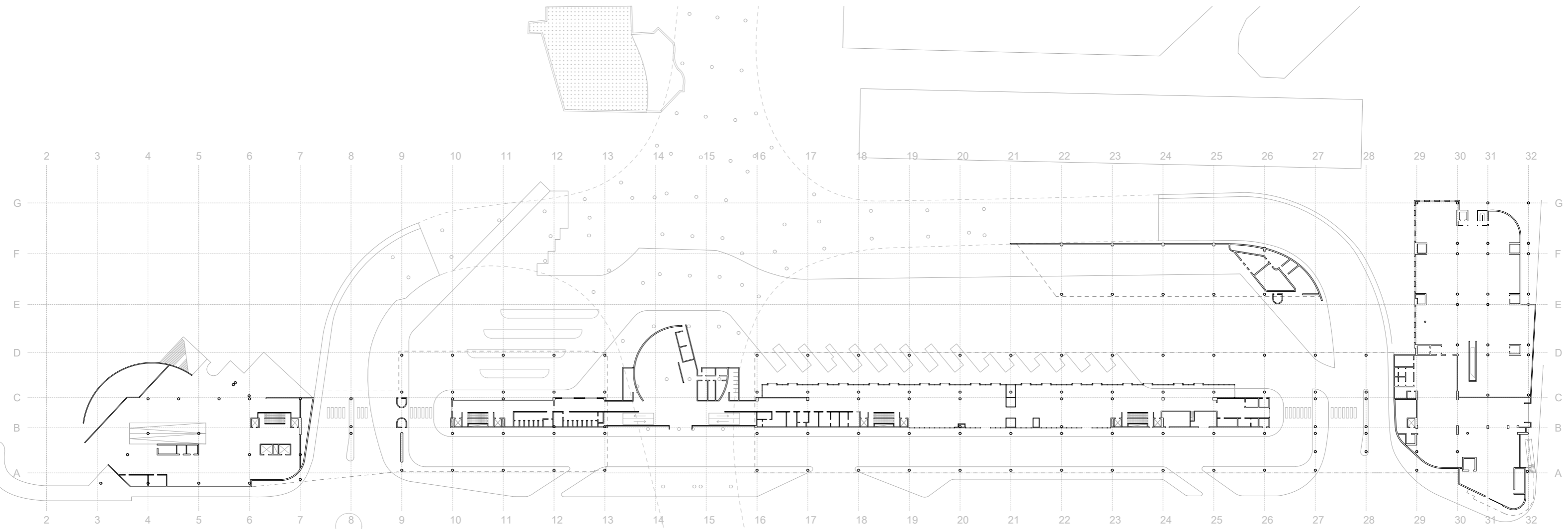

PLAN 0

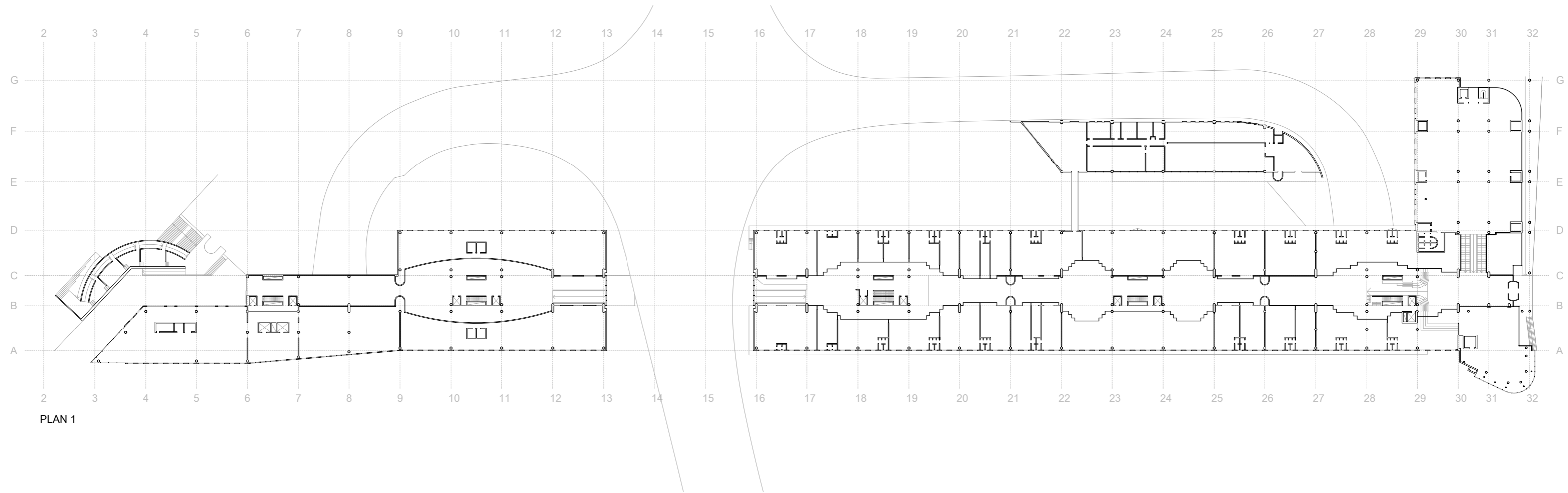

PLAN 1

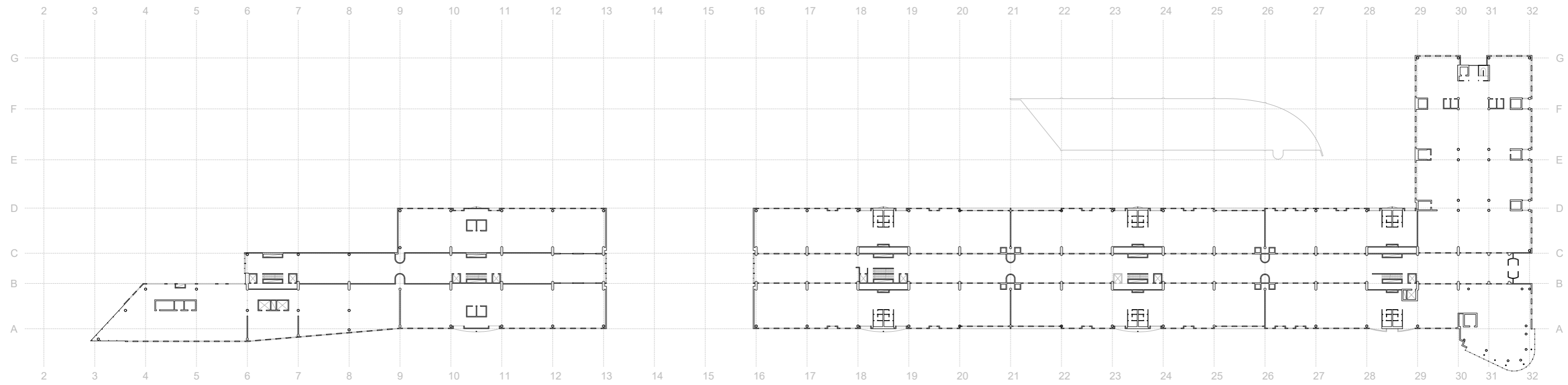

PLAN 2

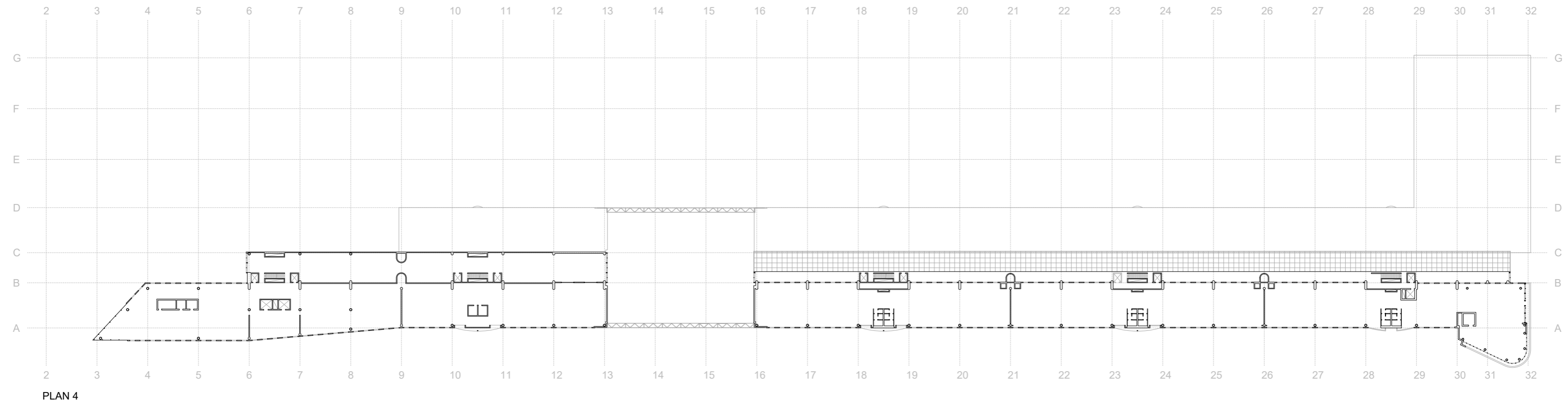
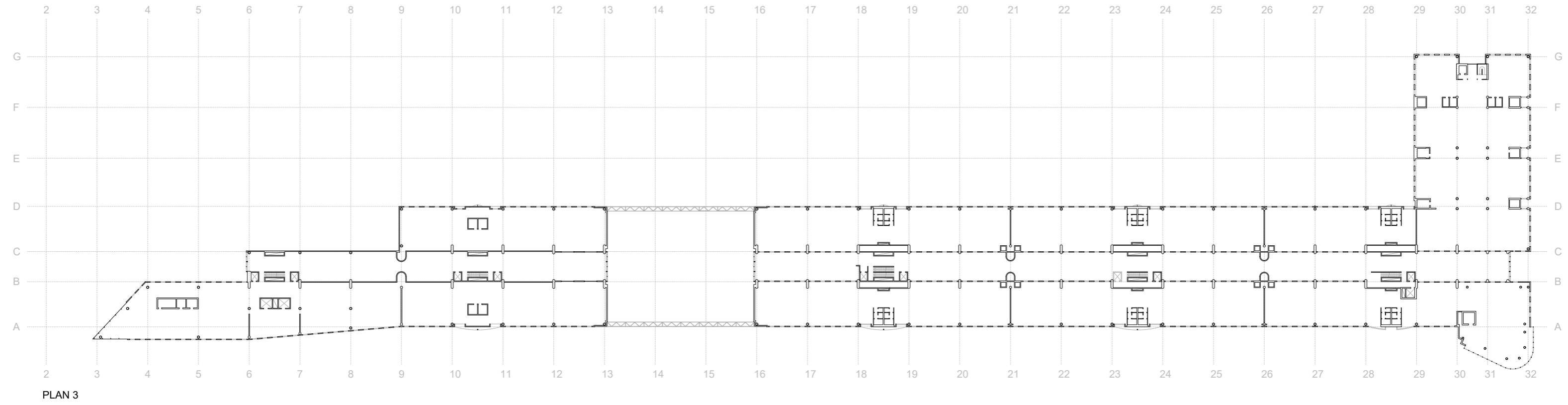

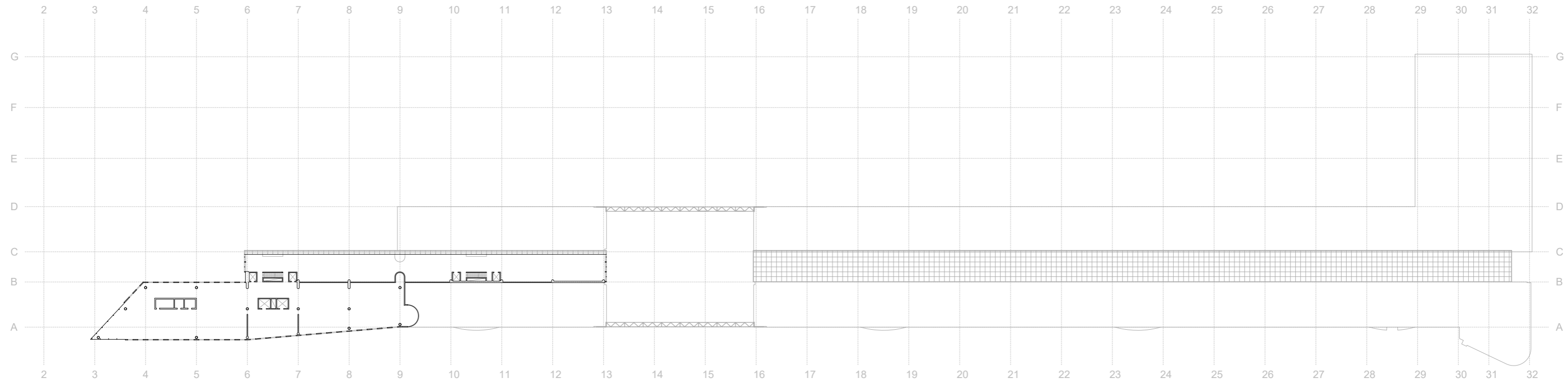

PLAN 5

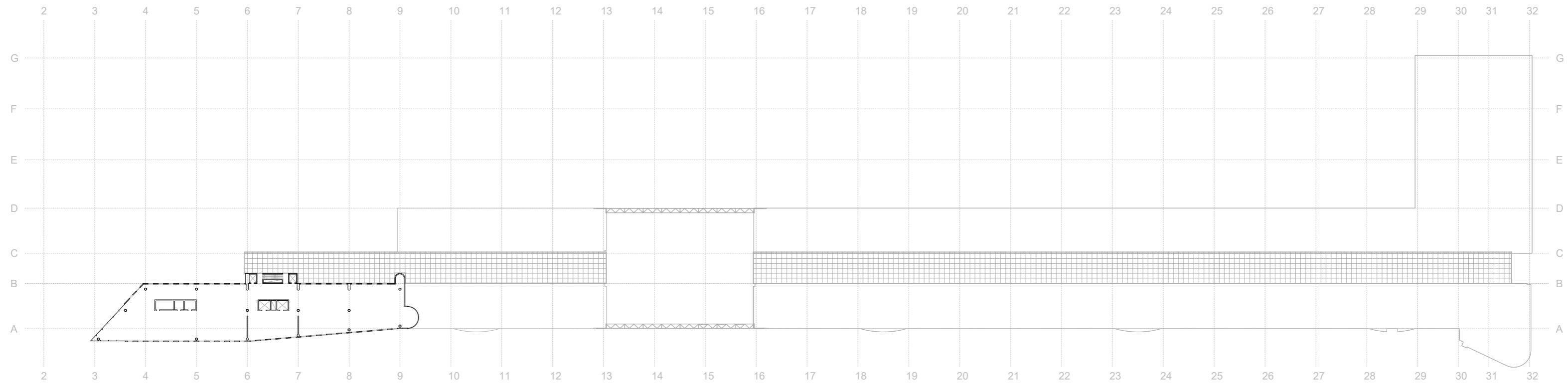

PLAN 6

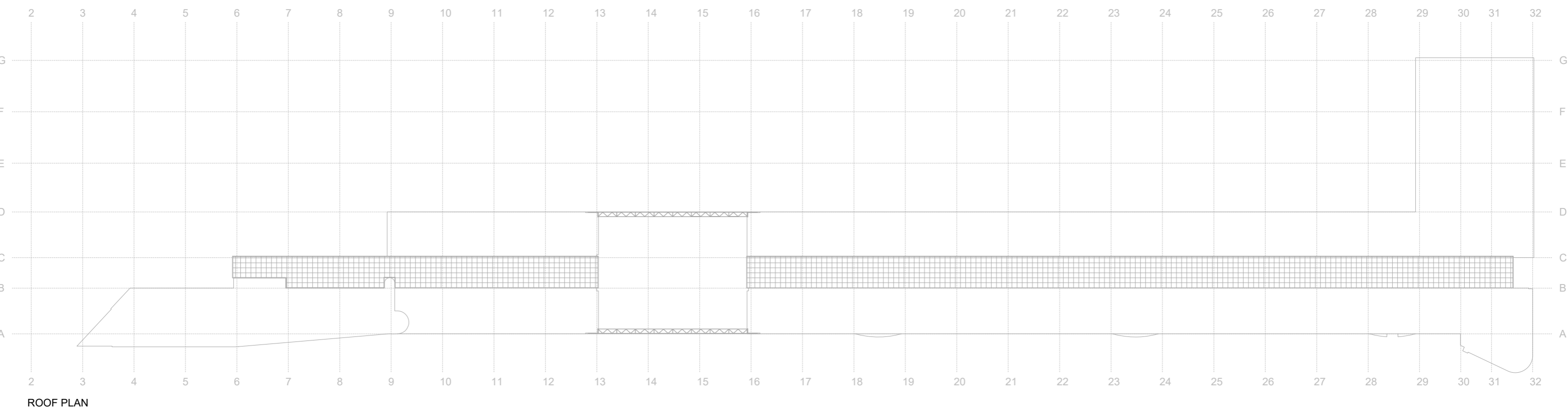

ROOF PLAN

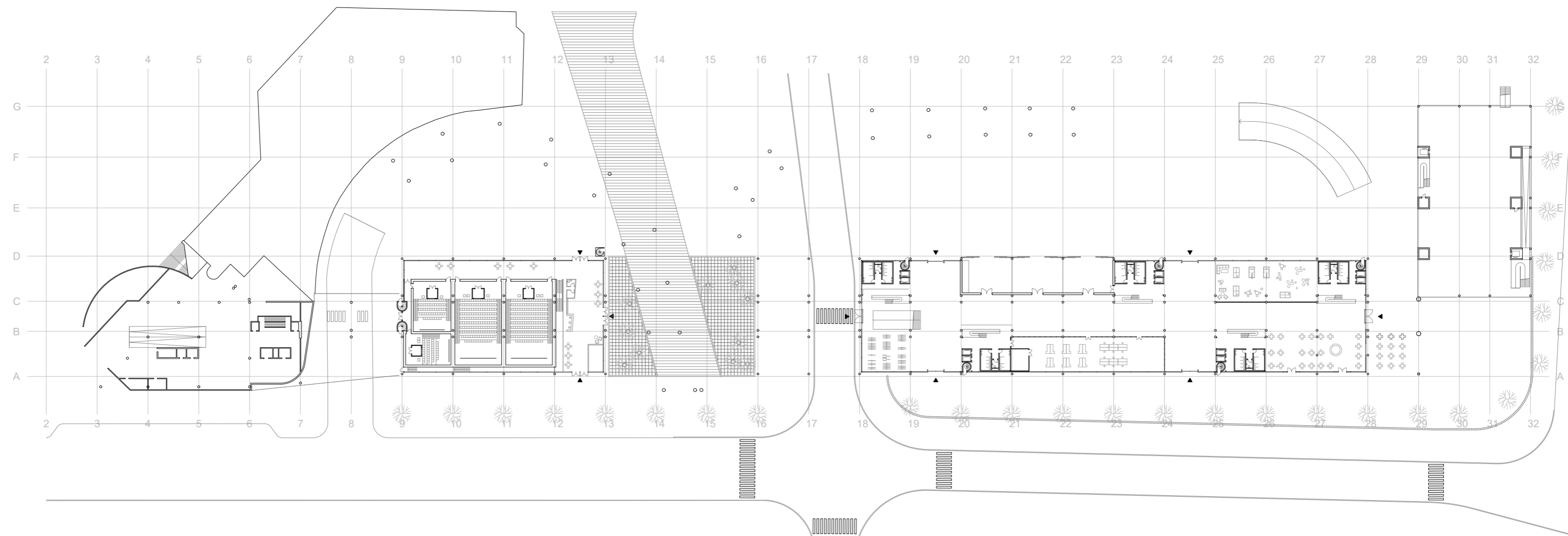
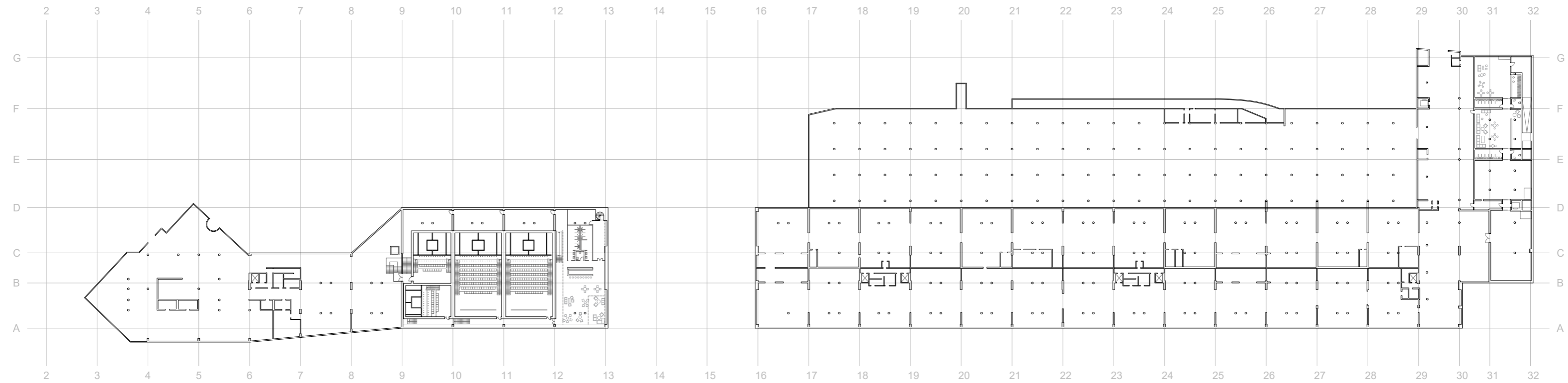

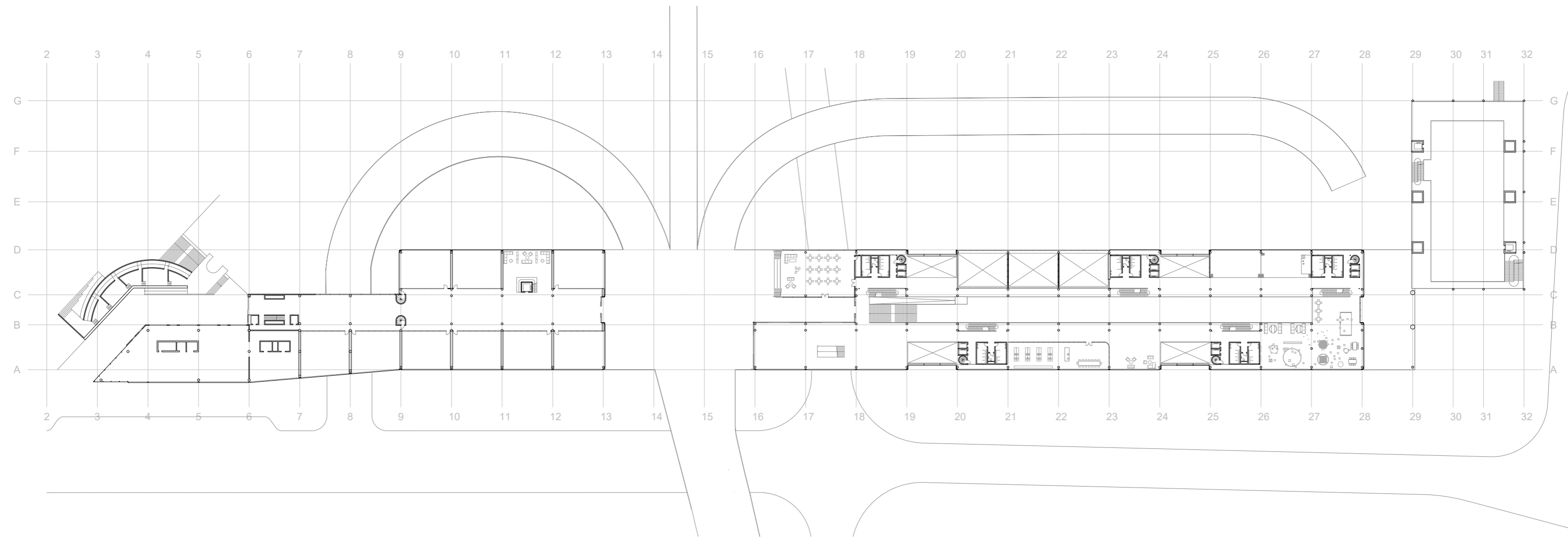

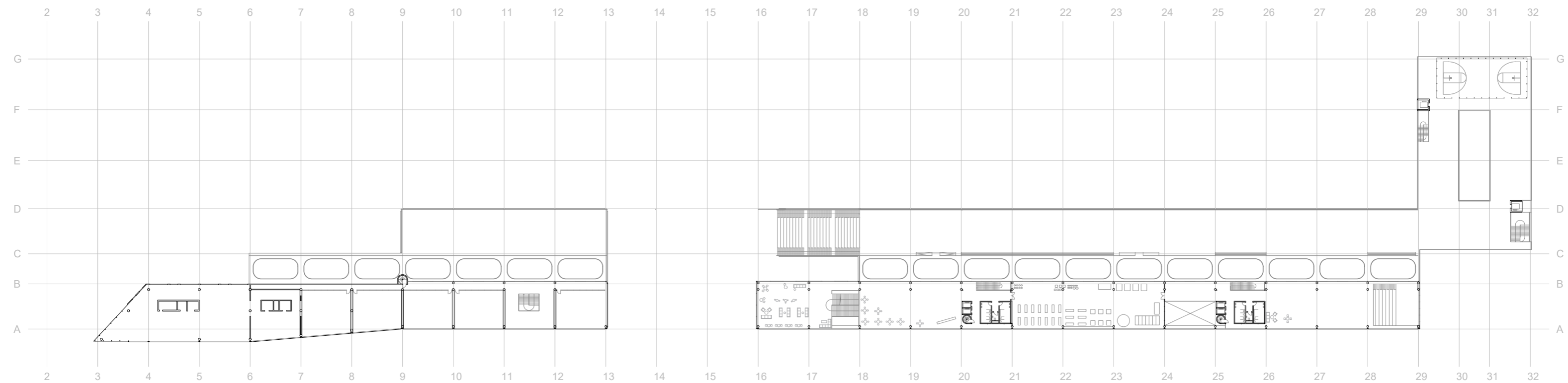
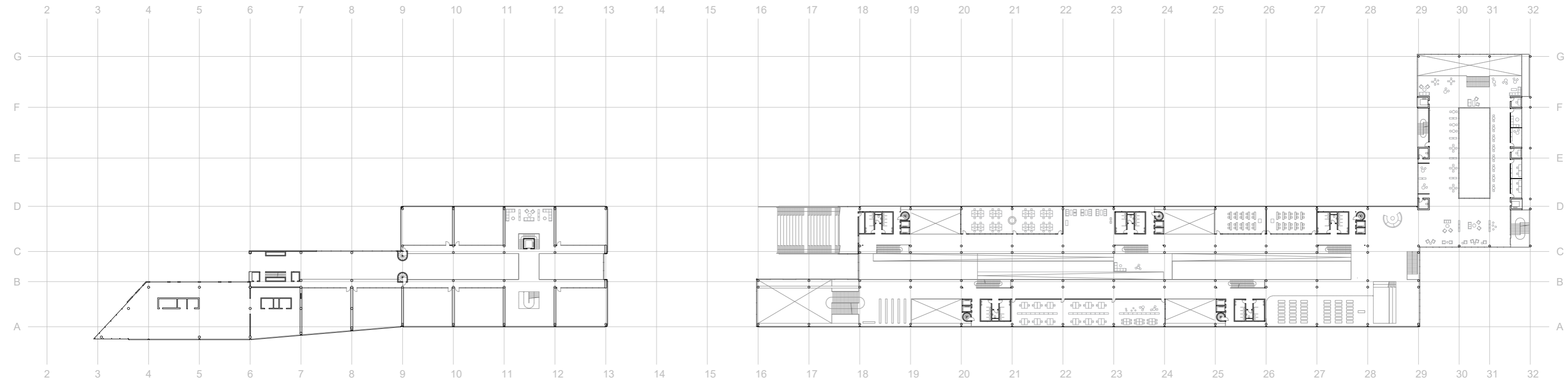

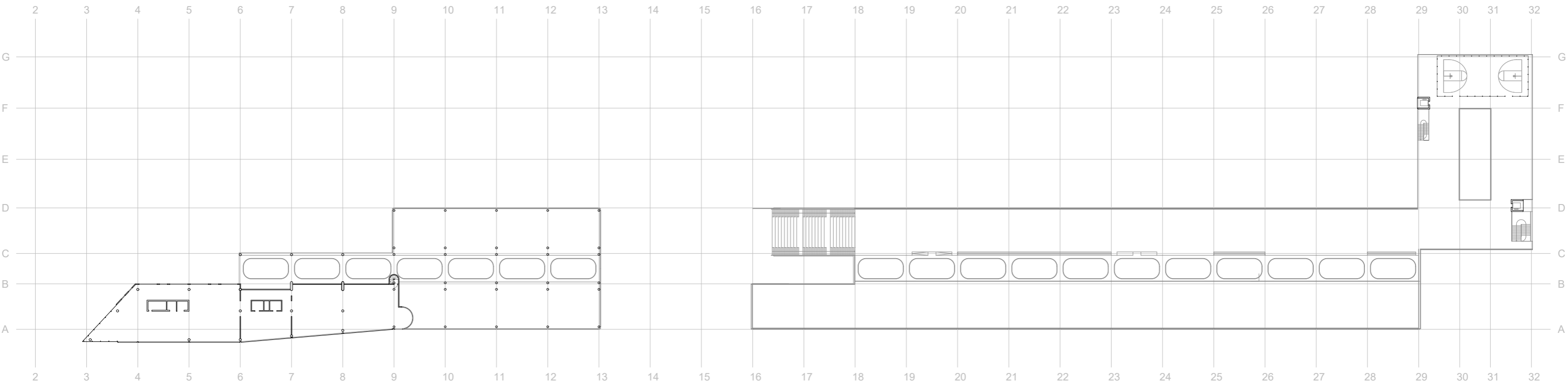

02 Siteplans



Waterland

Grønland

Oslo S



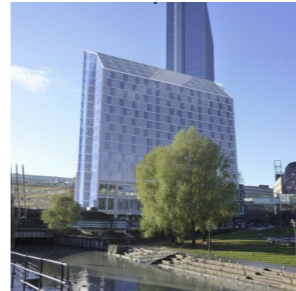

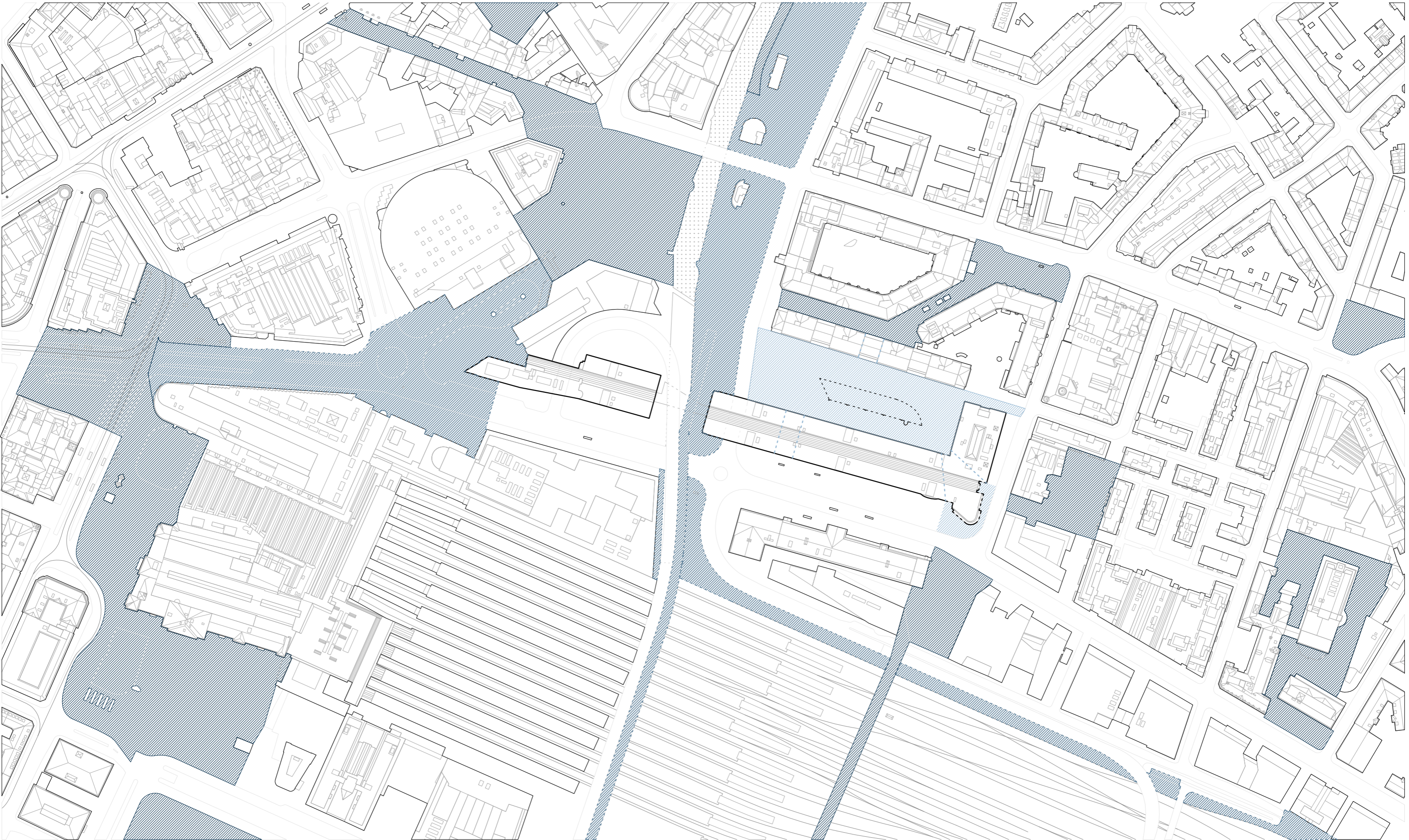

1:2500



Public space

-  existing
-  planned
-  project

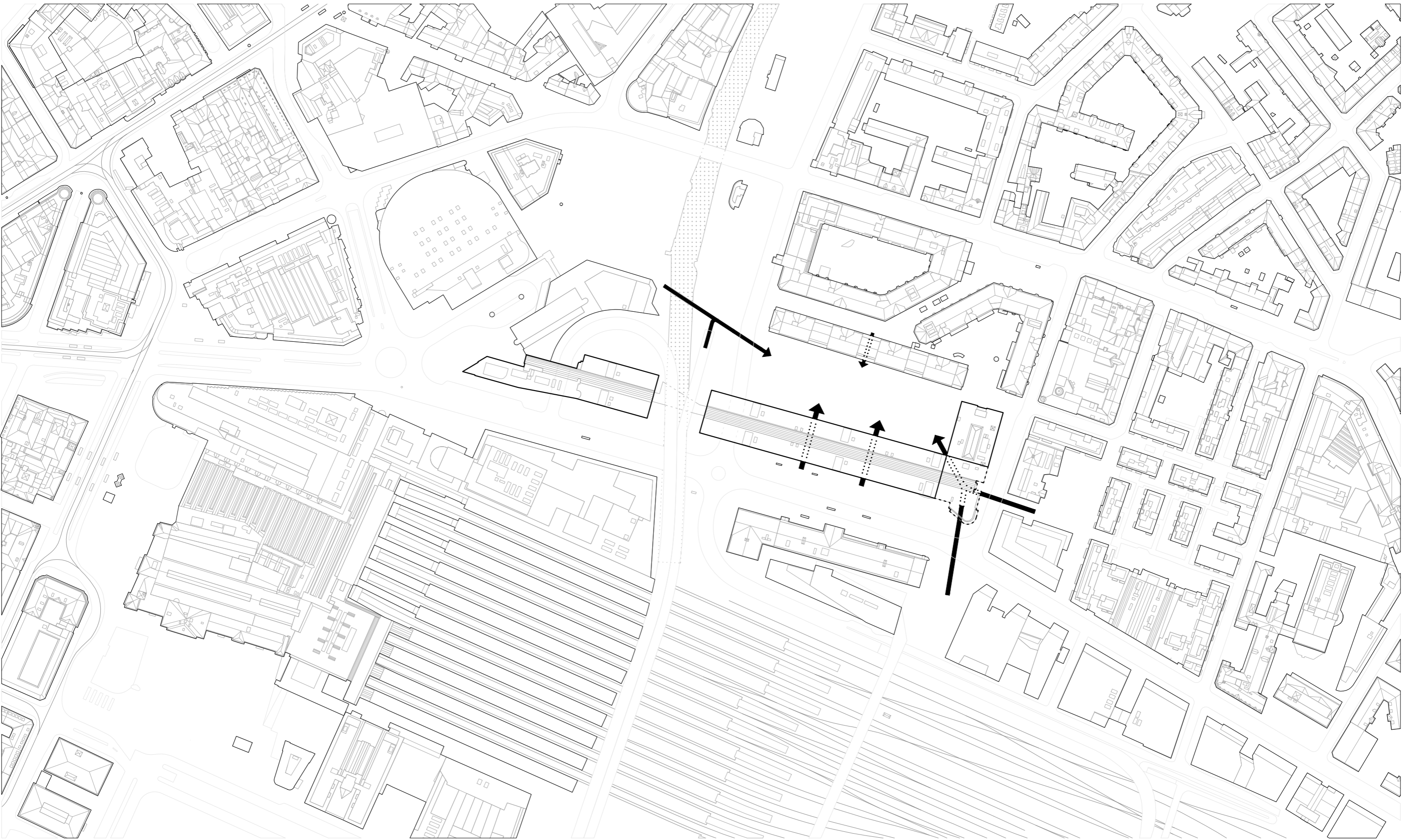

1:2500

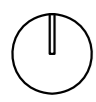

Grønland

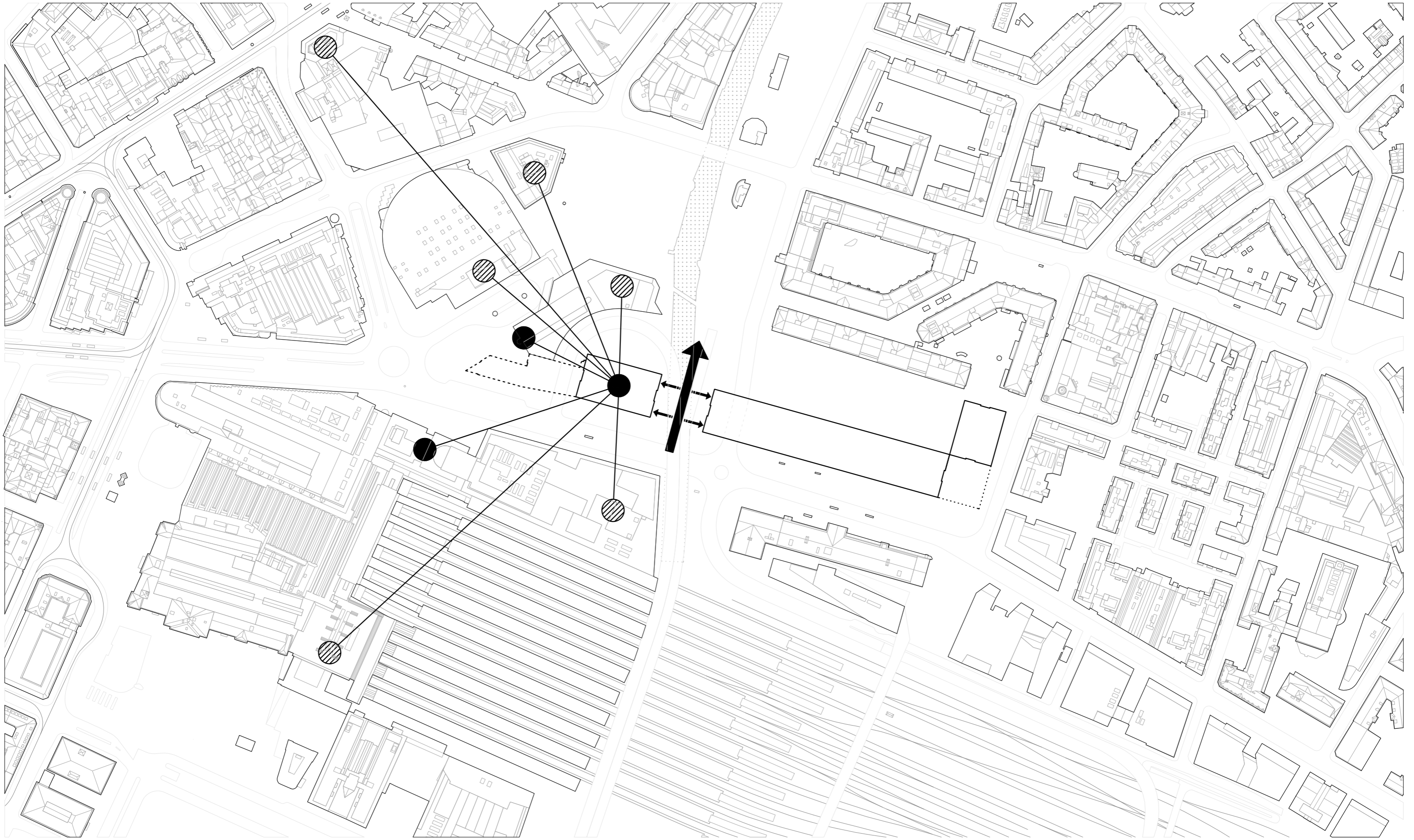

1:2500



Vaterland - Oslo S

- highrise
- ◉ proposed highrise

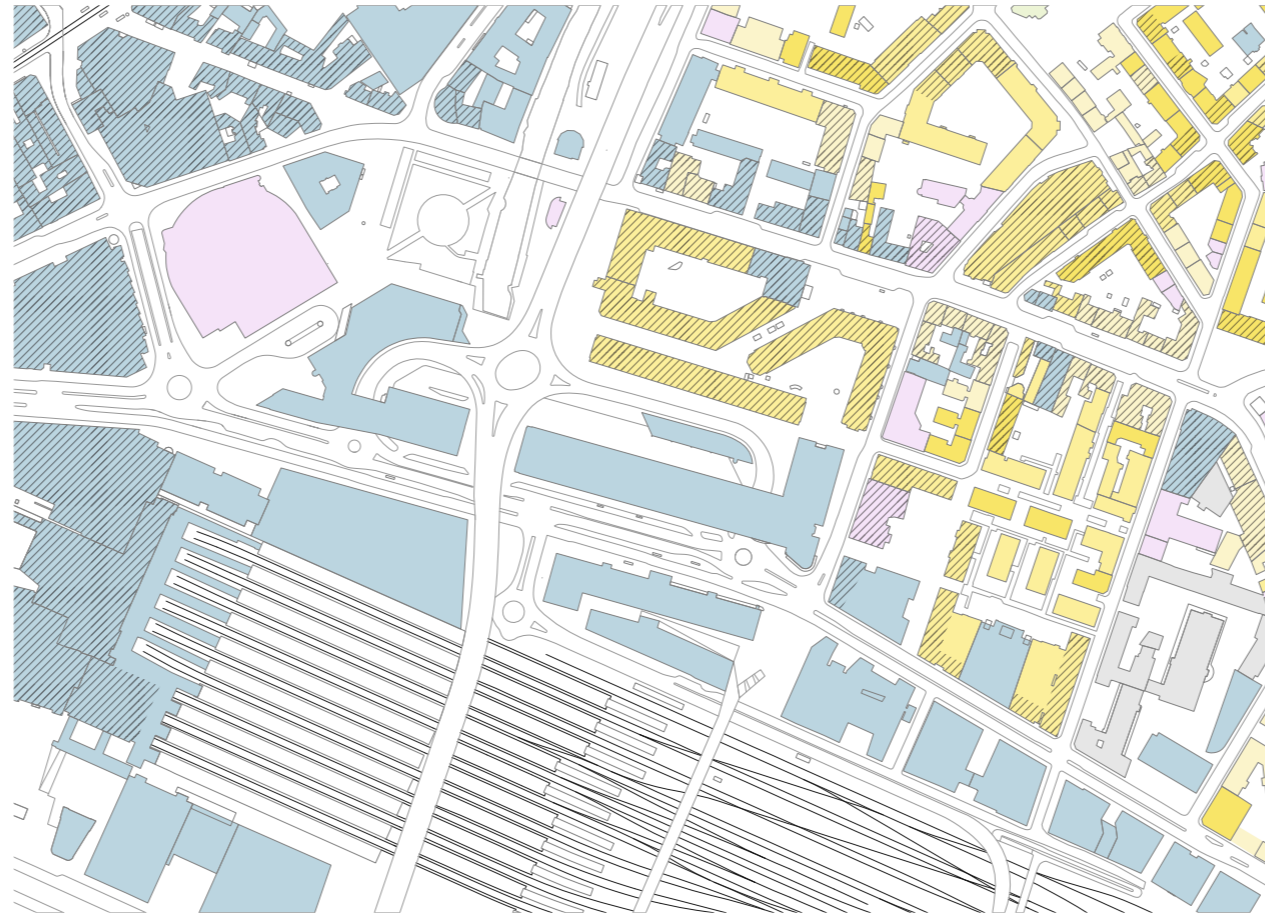

- Housing co-operative
- Co-ownership housing
- Other housing

- Office and retail
- Non-commercial, public services
- ▨ Retail on ground floor

- Kindergarten
- Kindergarten

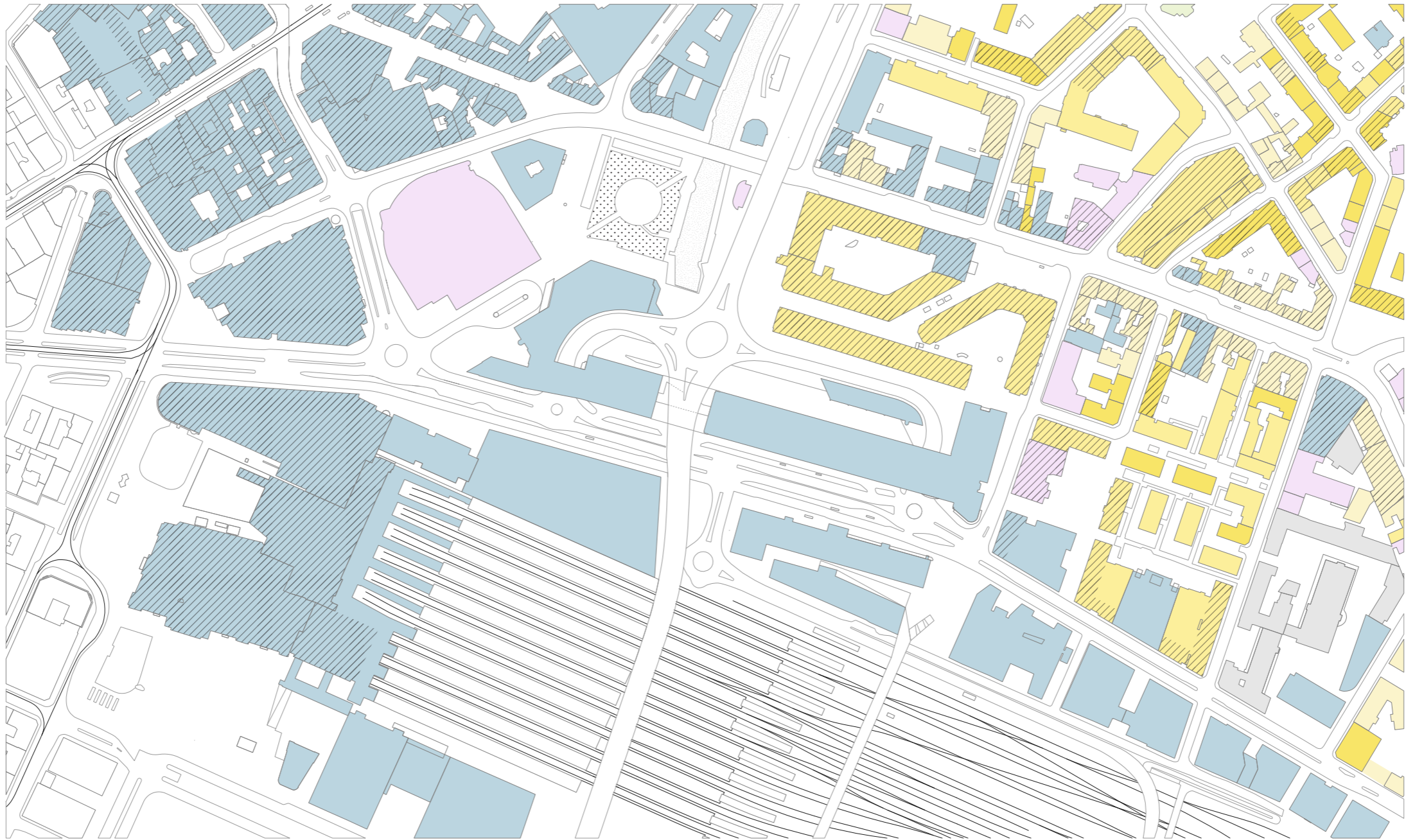

1:5000

- Housing co-operative
- Co-ownership housing
- Other housing

- Office and retail
- Non-commercial, public services
- ▨ Retail on ground floor

- Kindergarten
- Under development

03 Sections

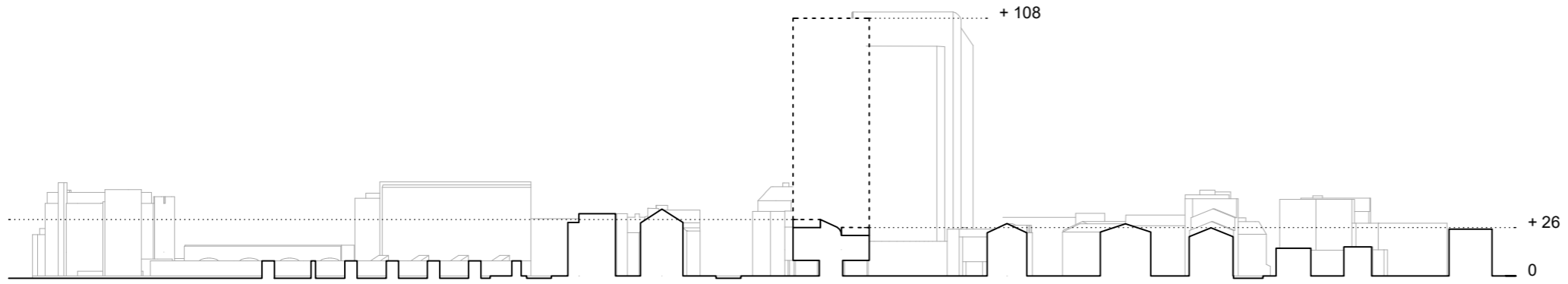
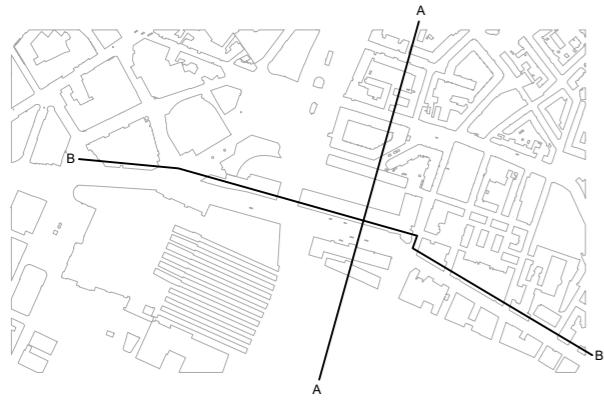

Section A - A

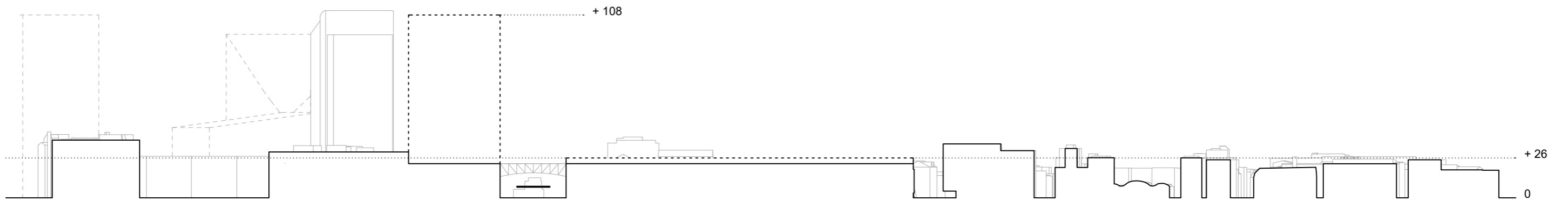

Section B - B

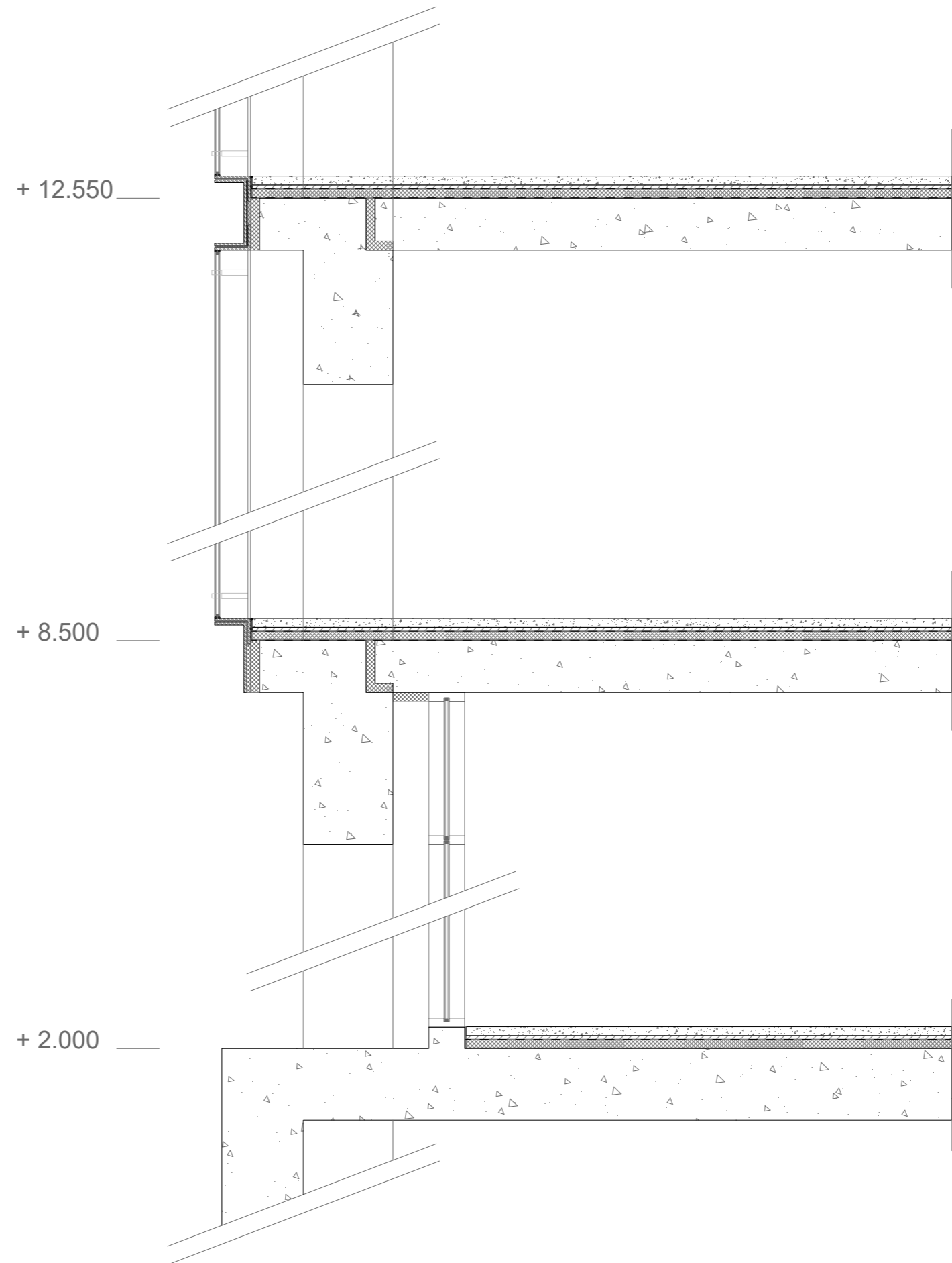

1:20

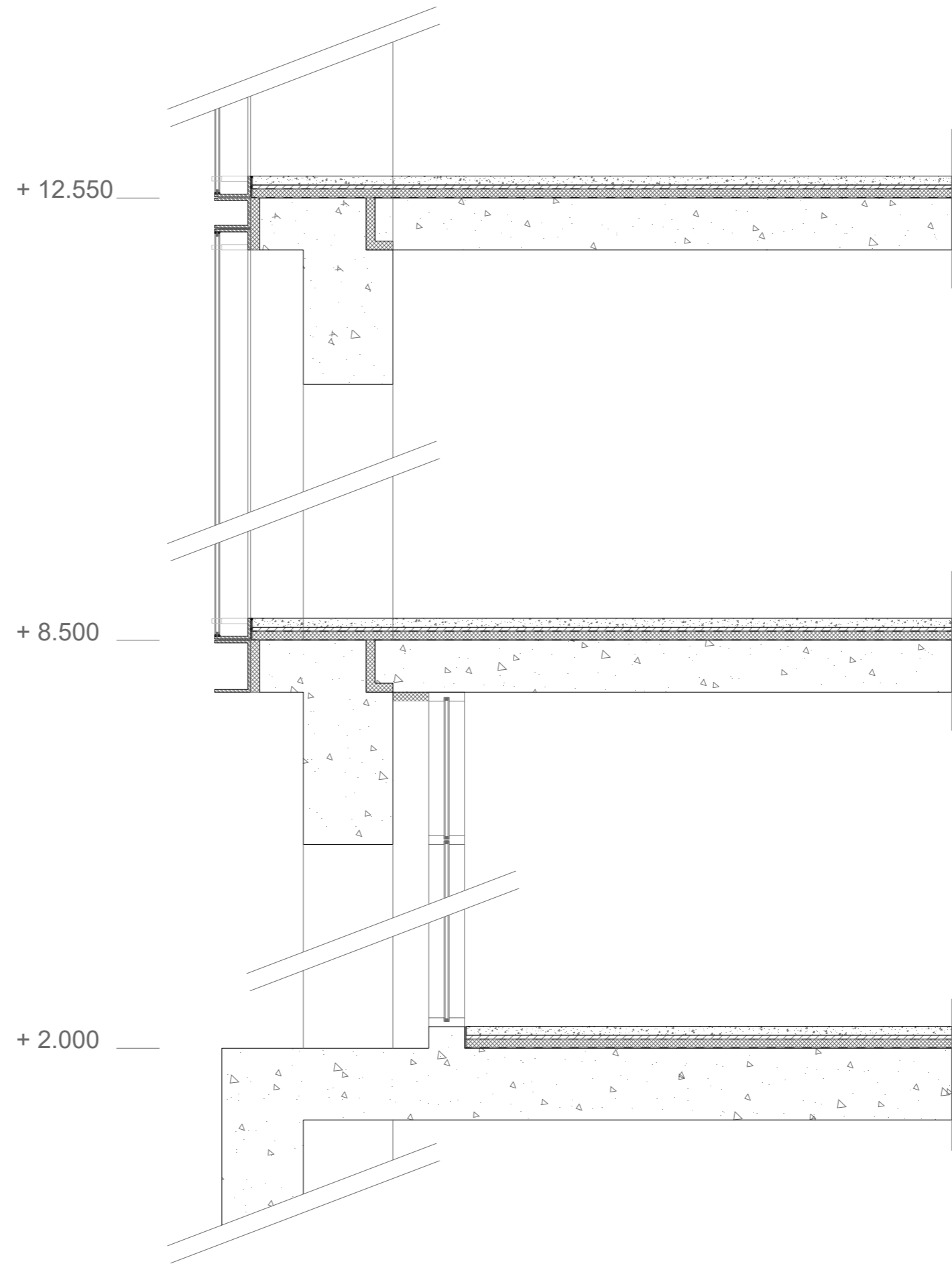

1:20

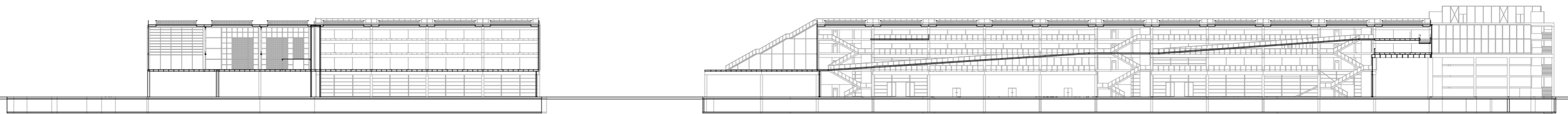
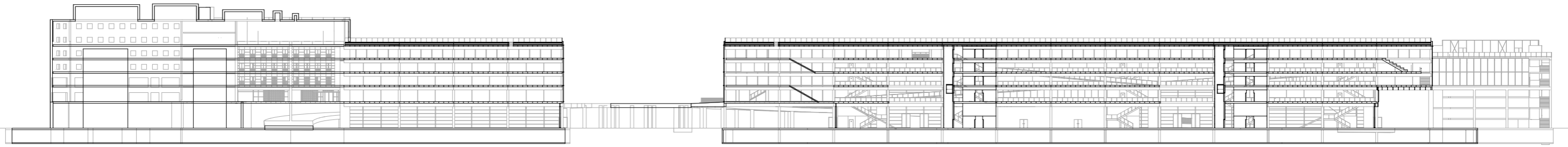

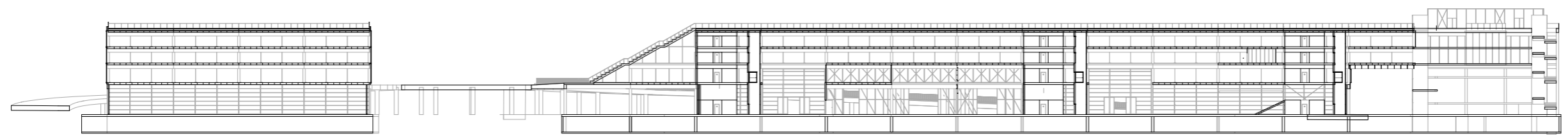
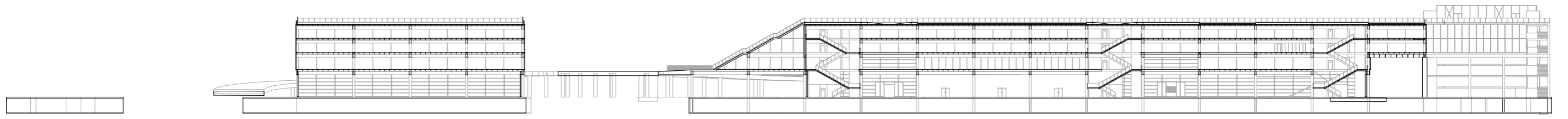

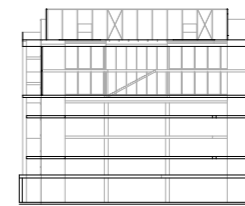
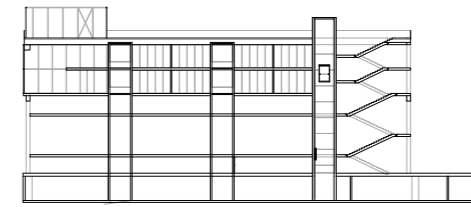
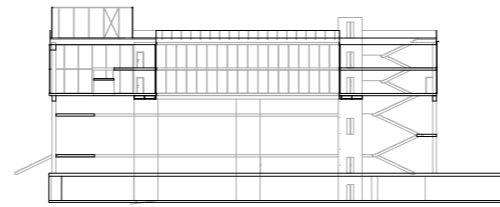
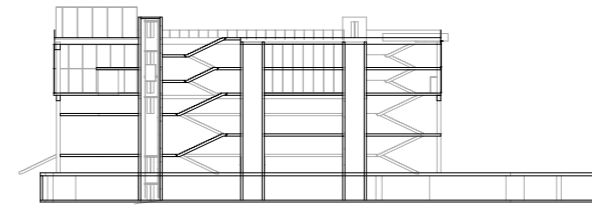
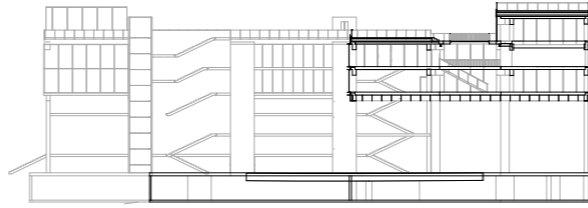
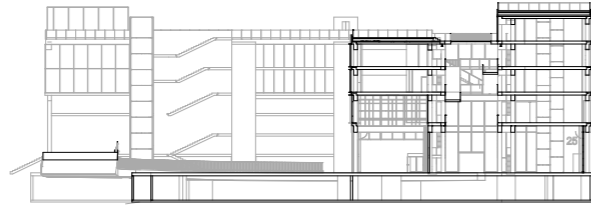

04 Axonometries

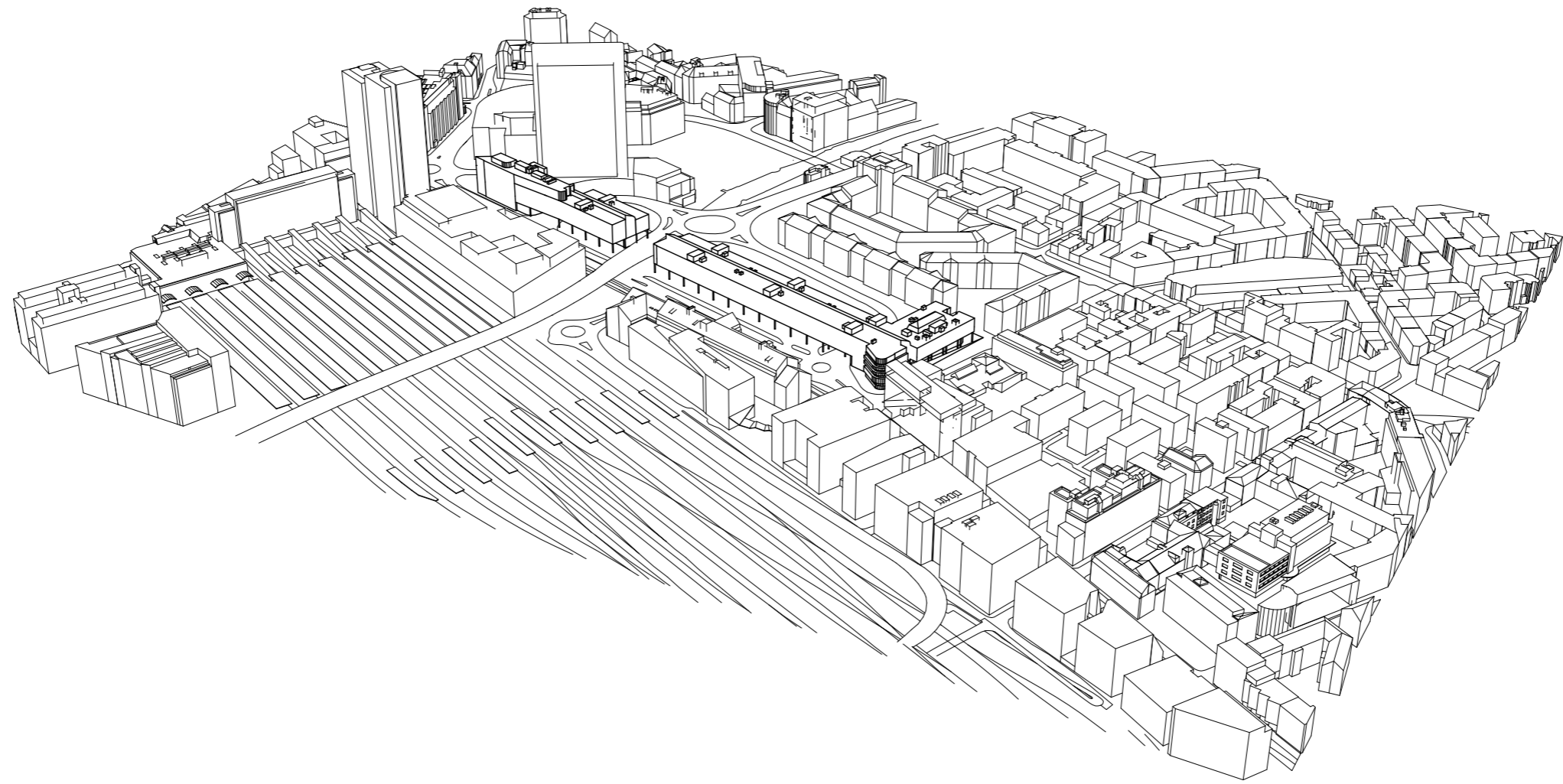

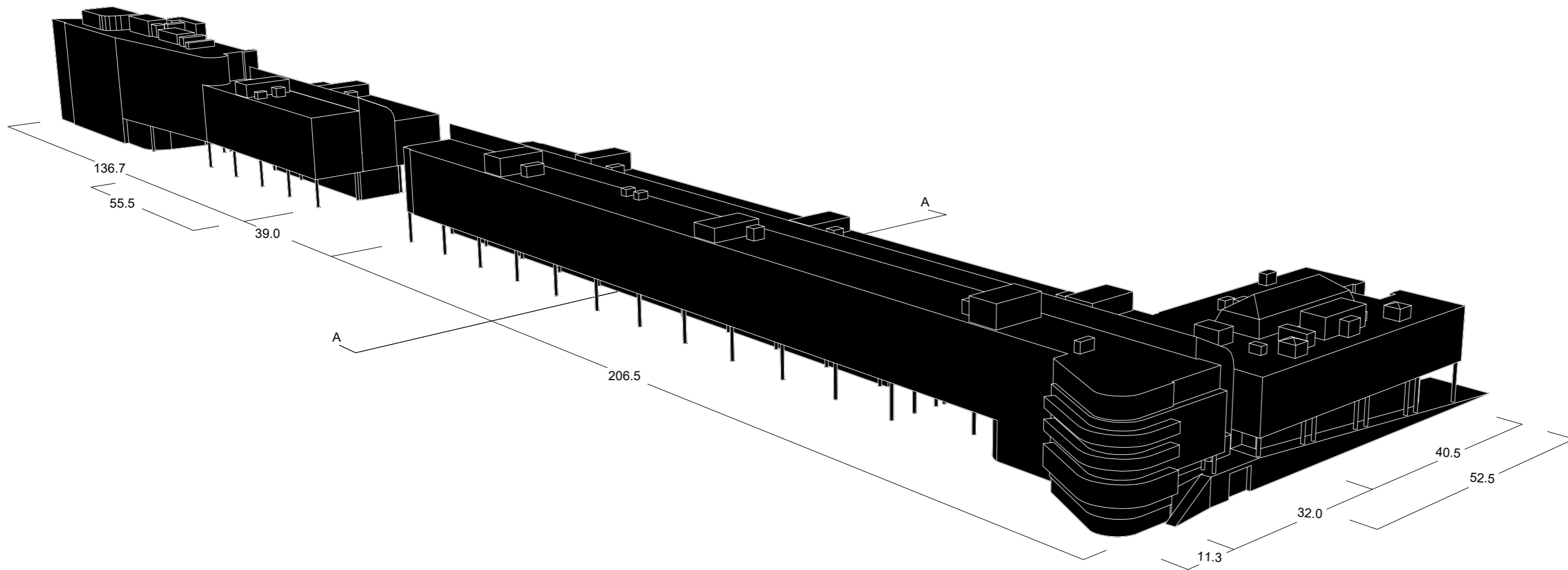

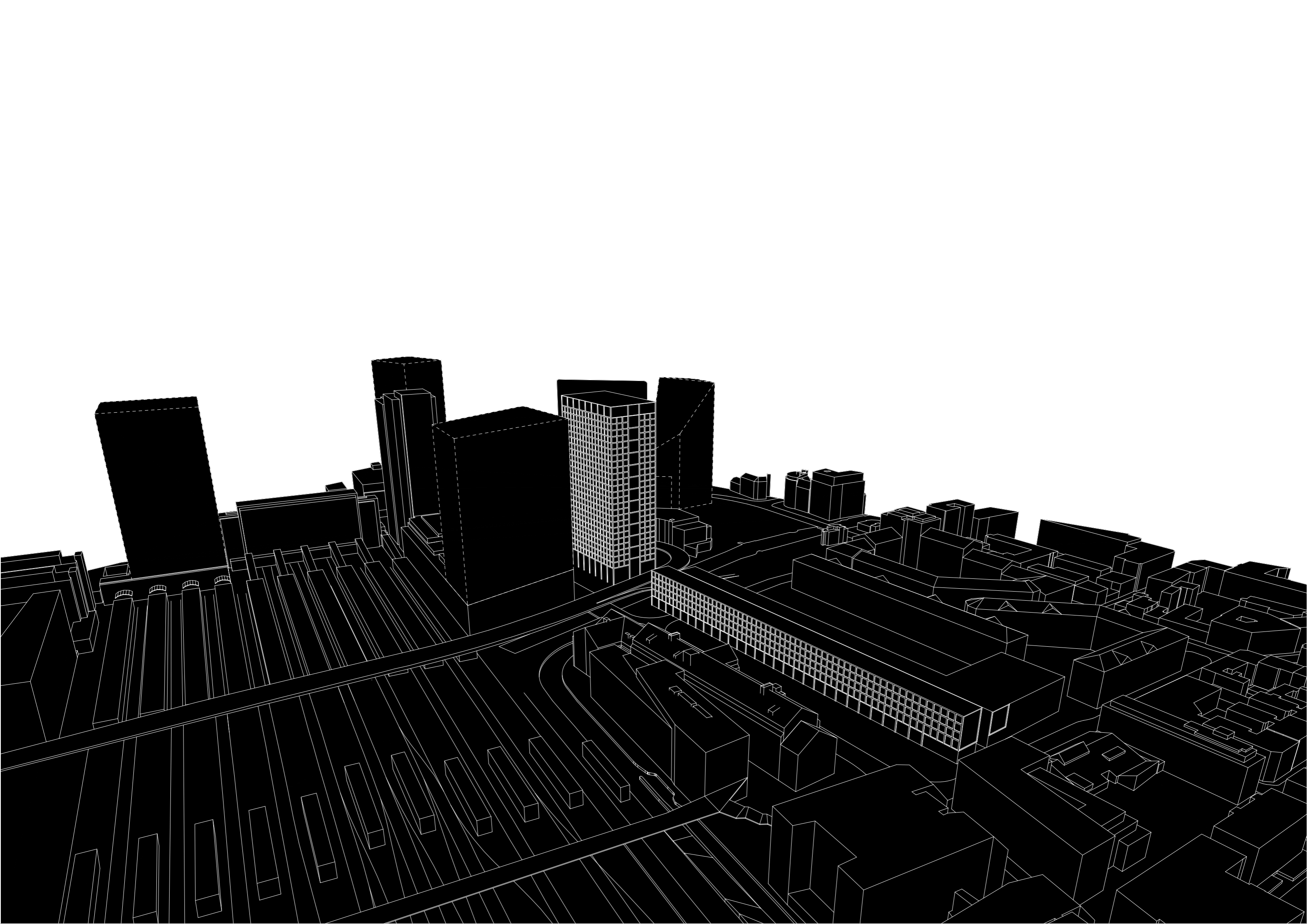

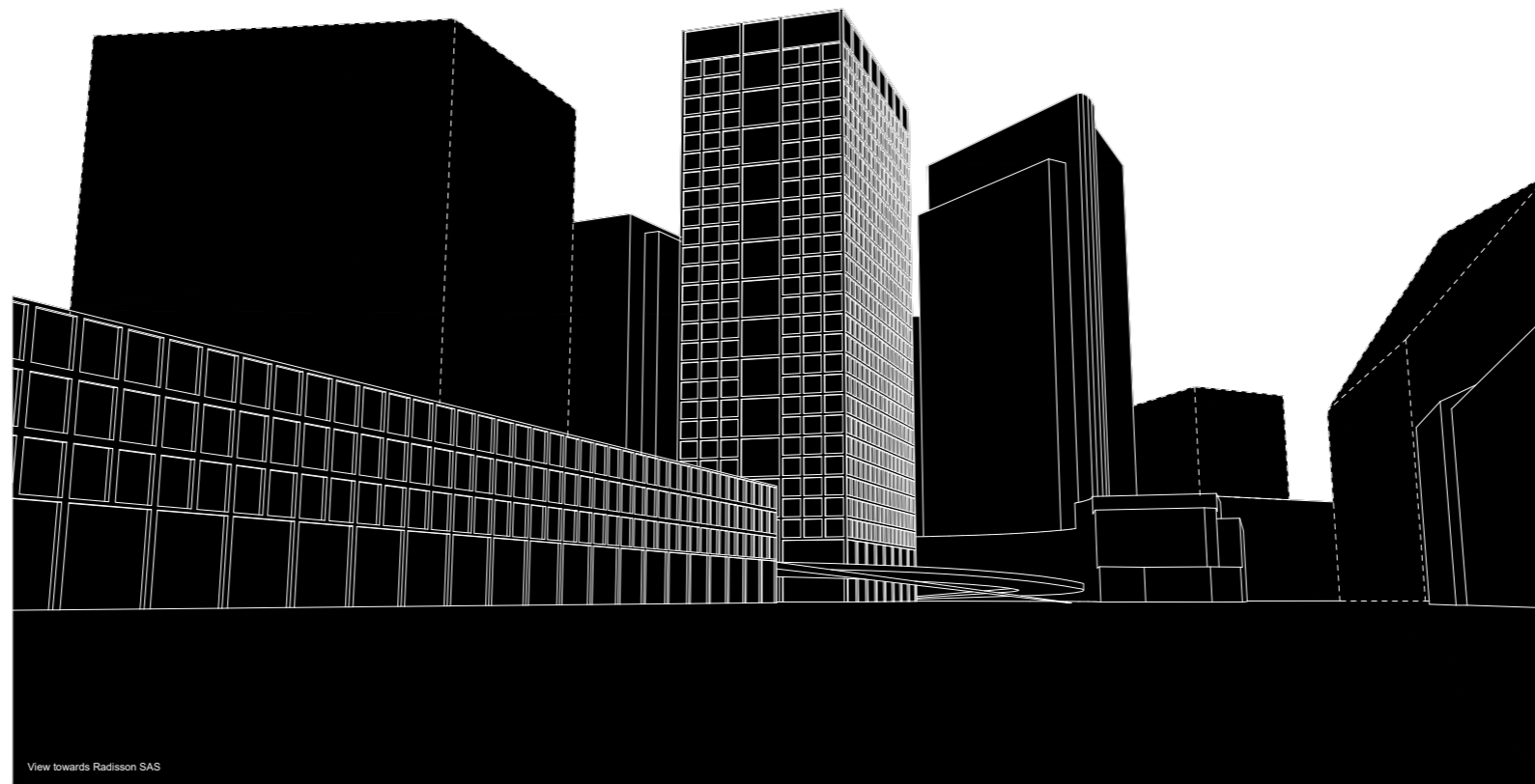
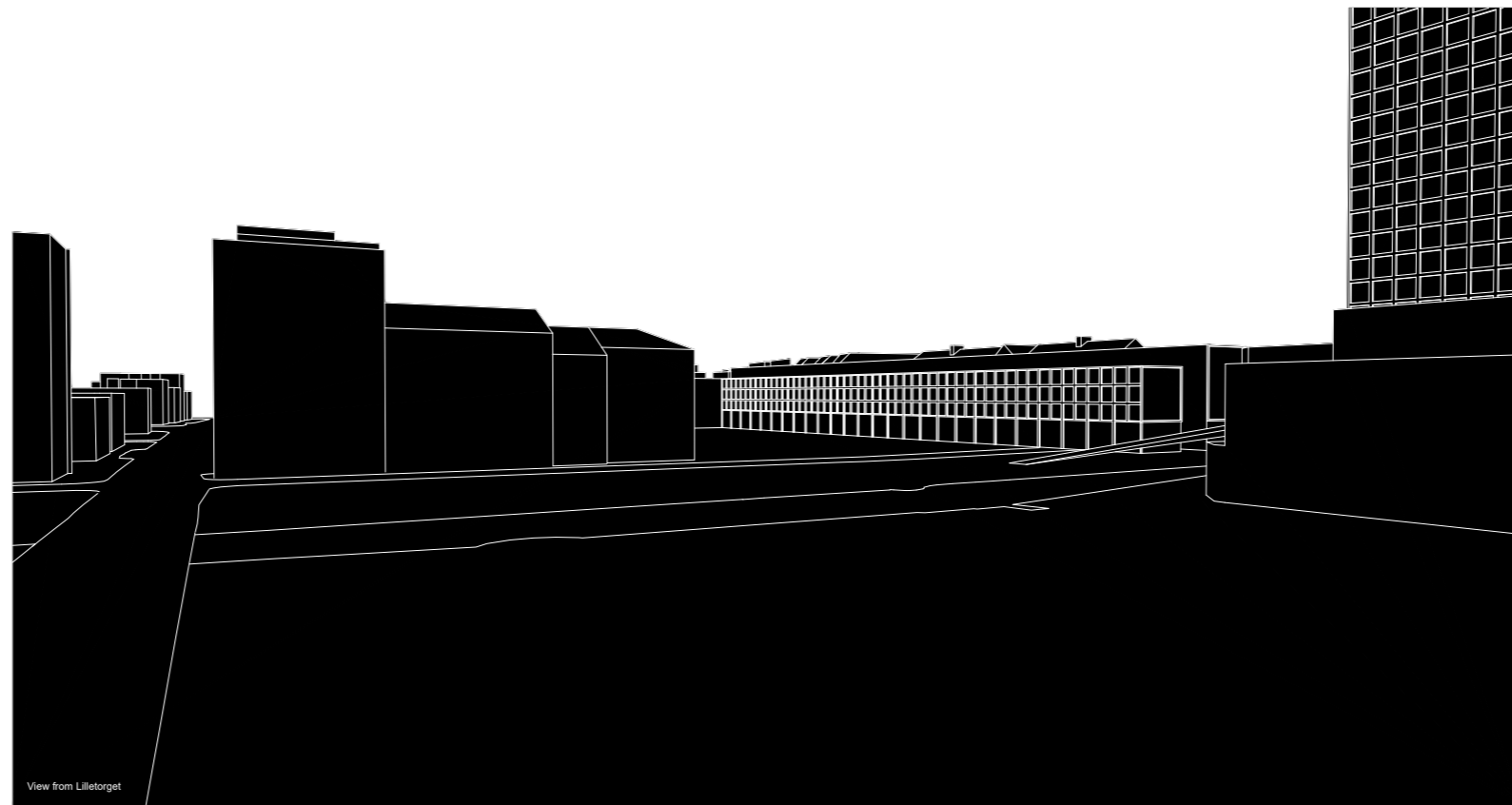

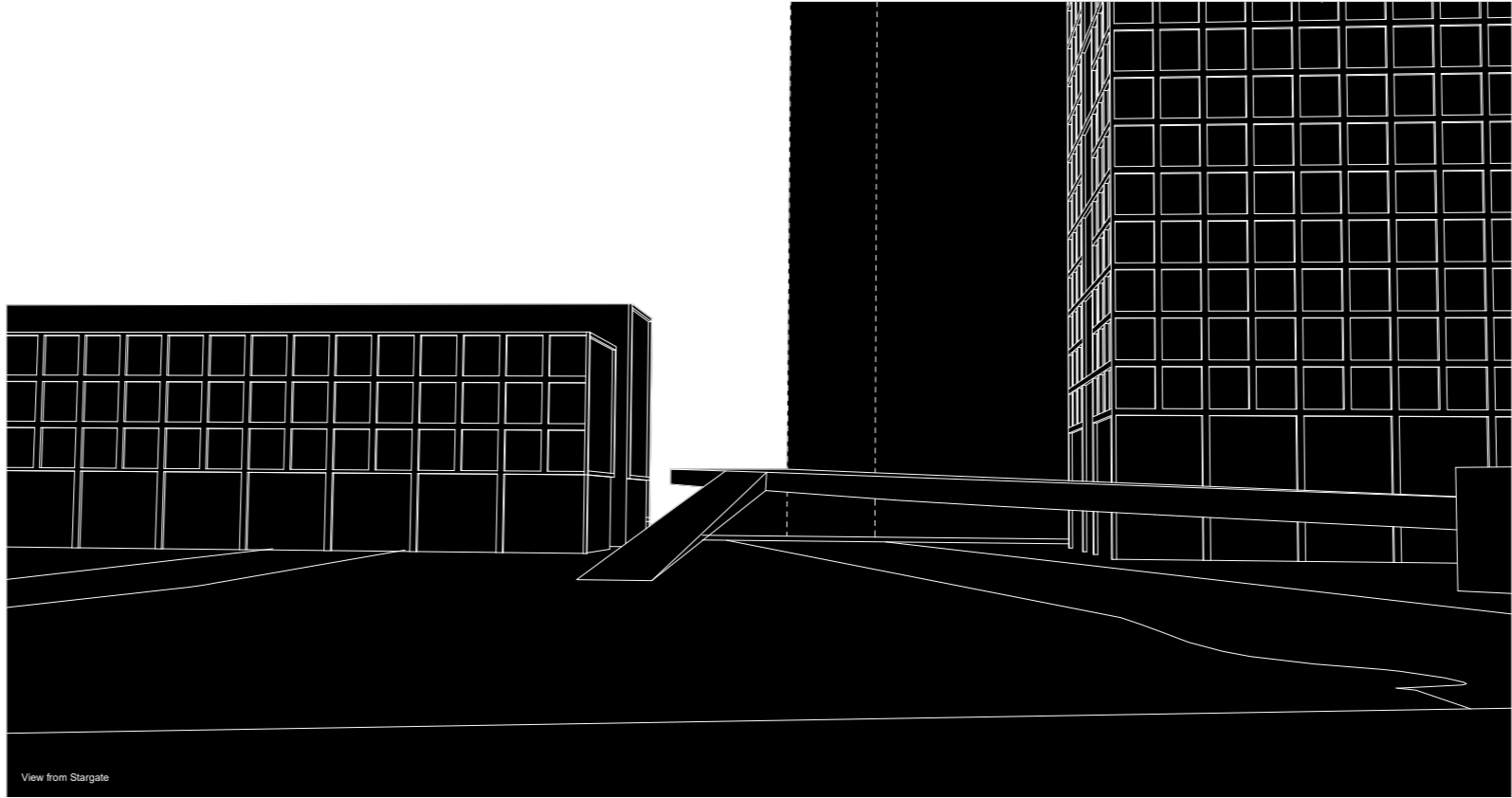

View from Stargate

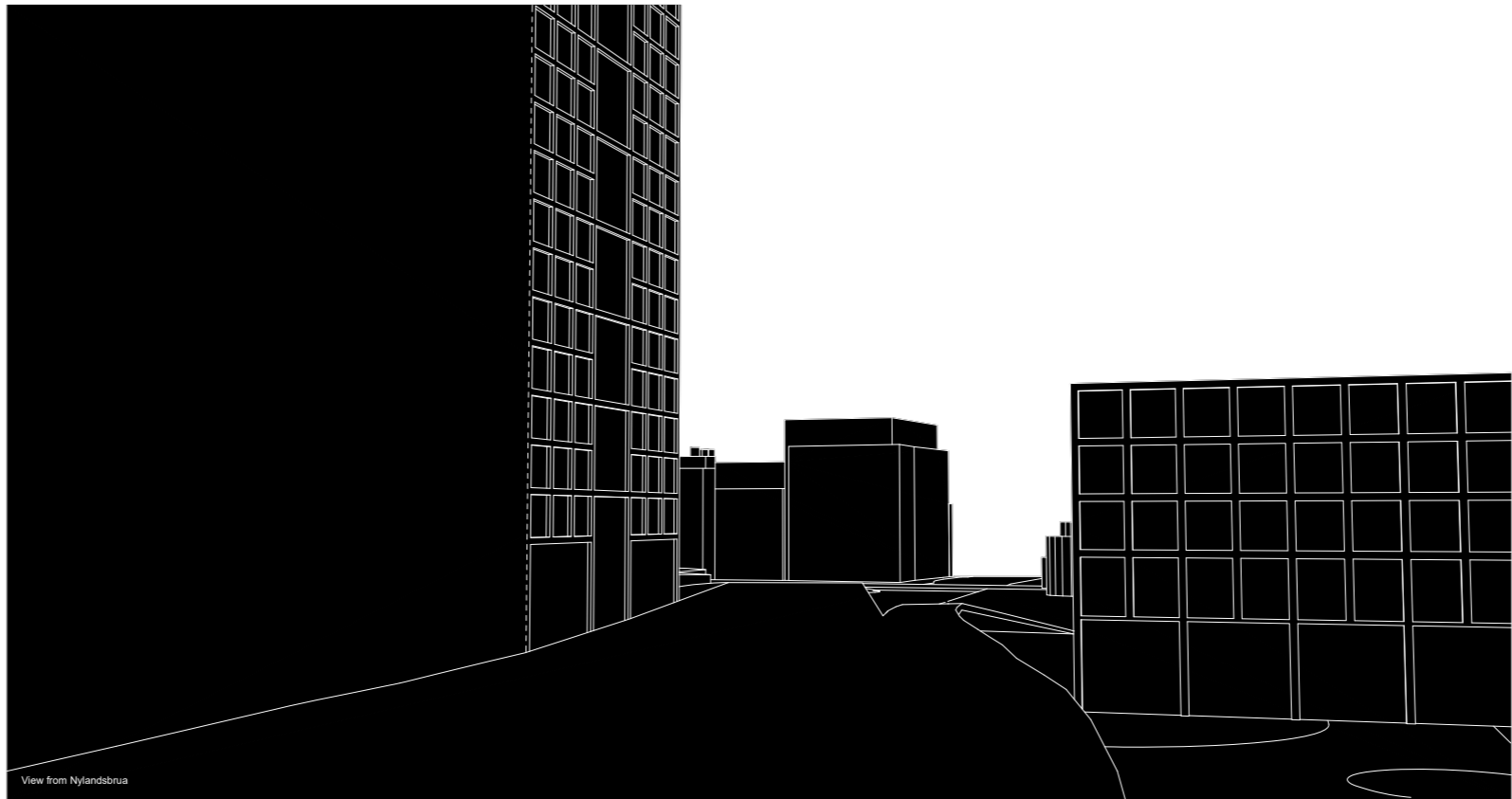

View from Nylandsbrua

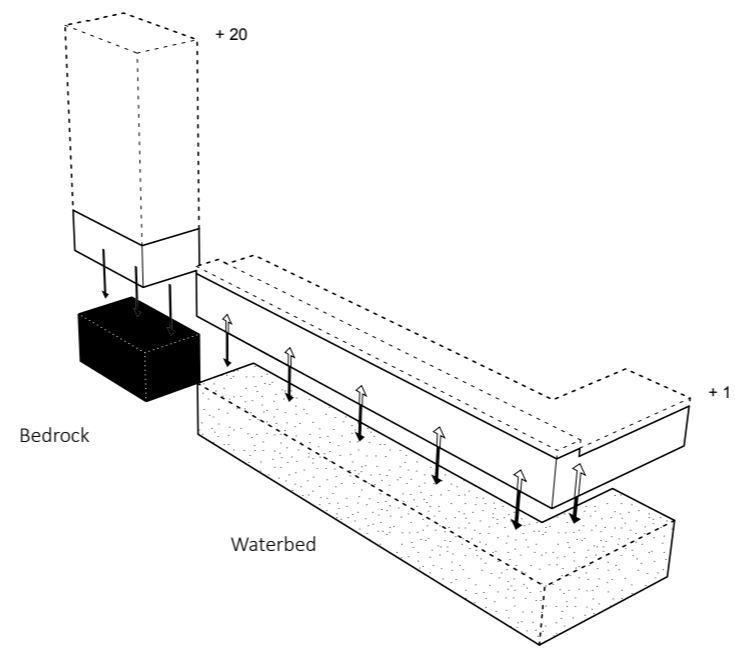
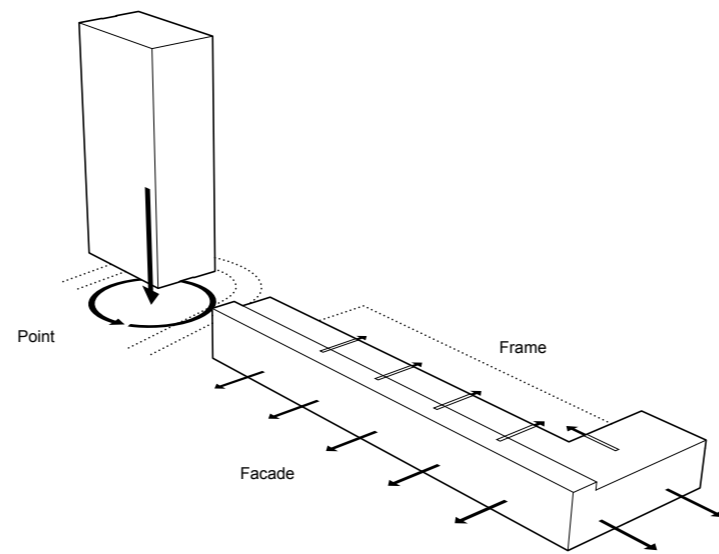
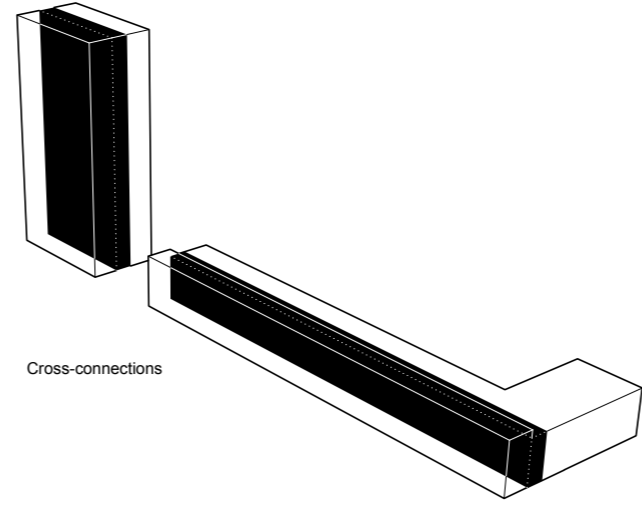

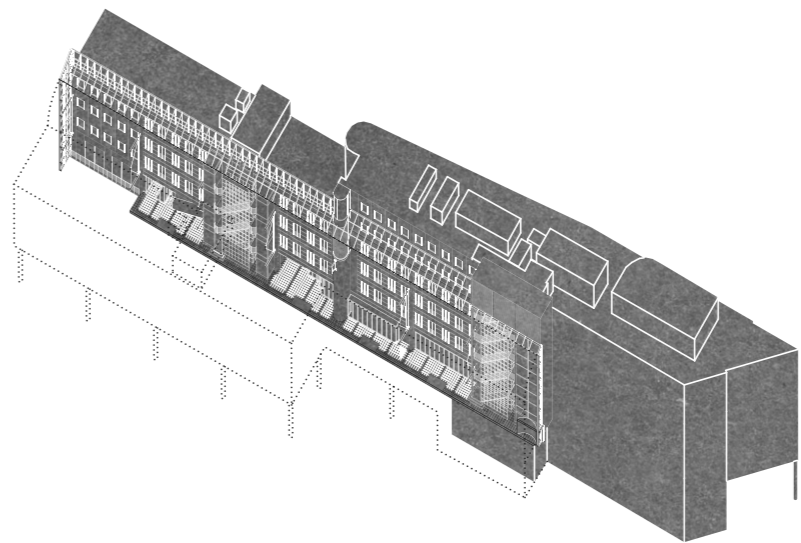
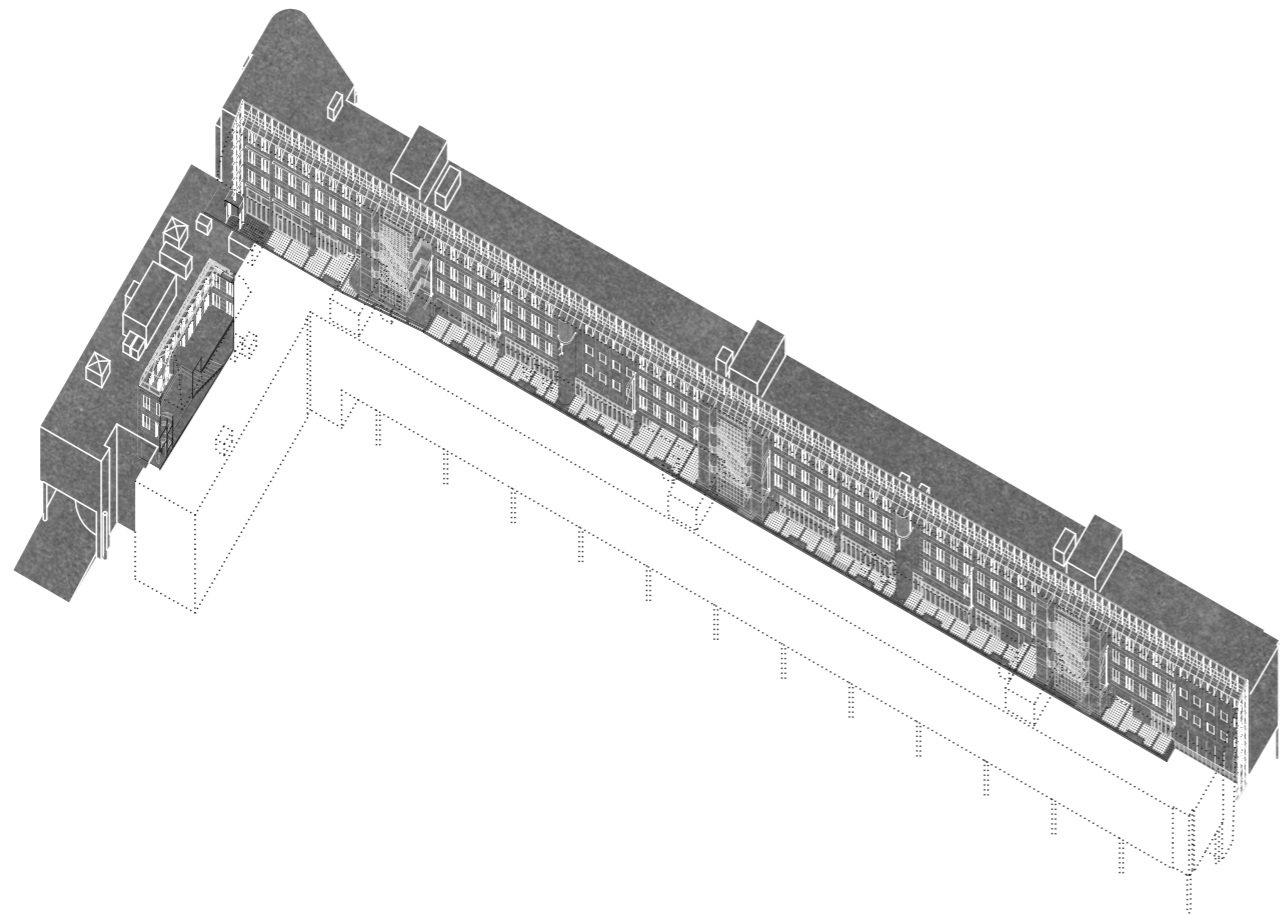
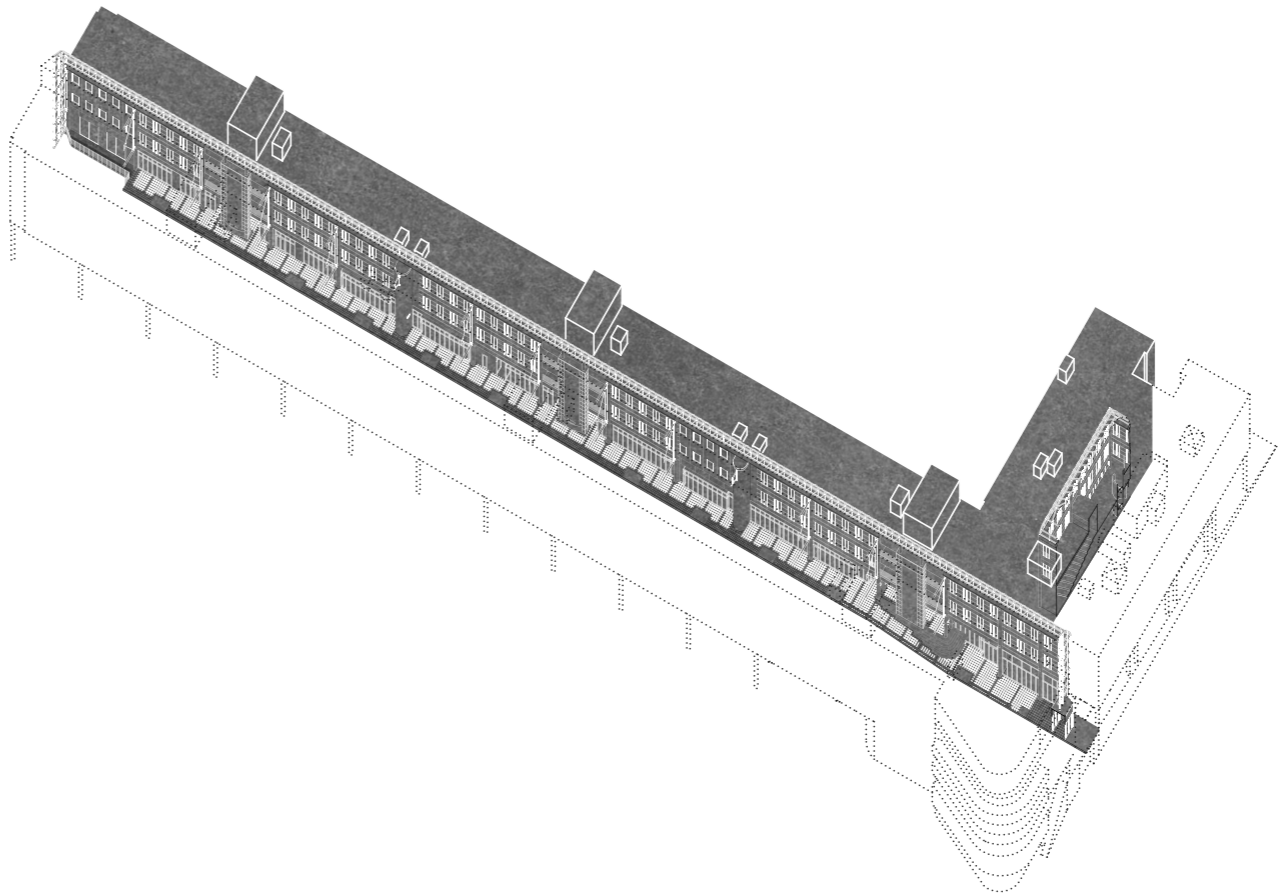
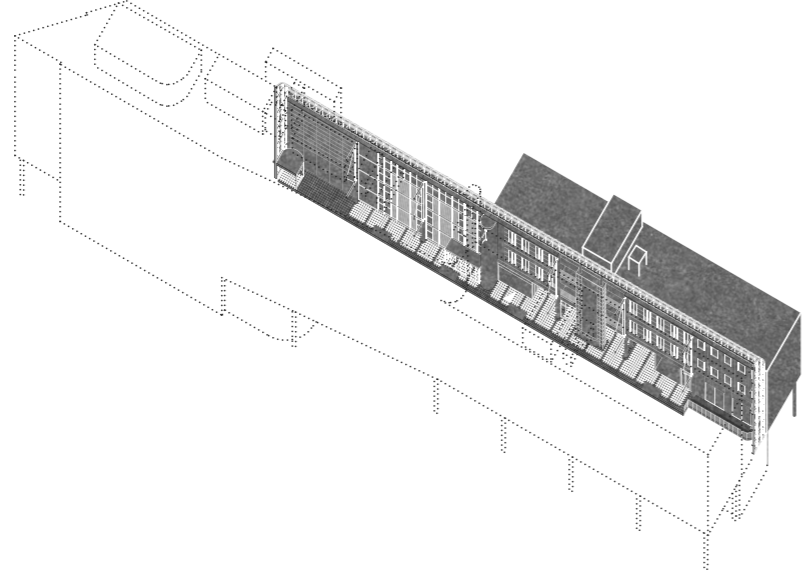

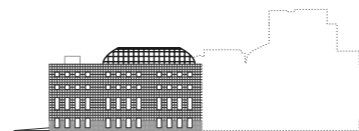
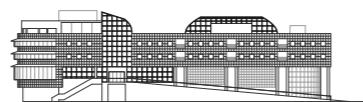
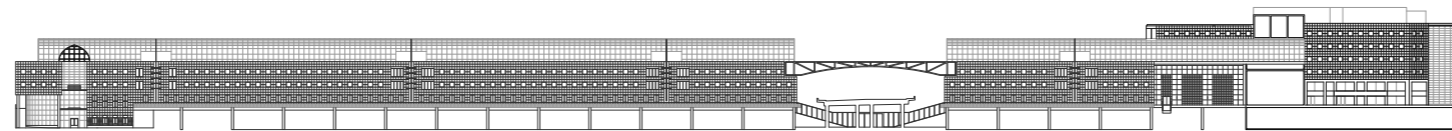
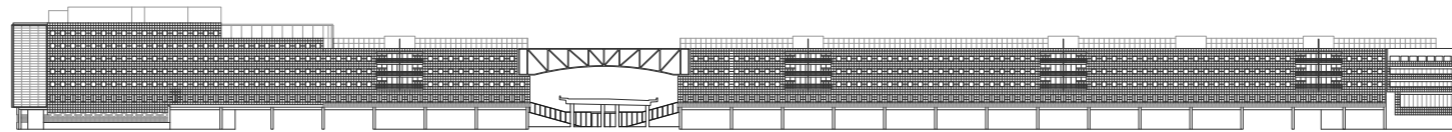
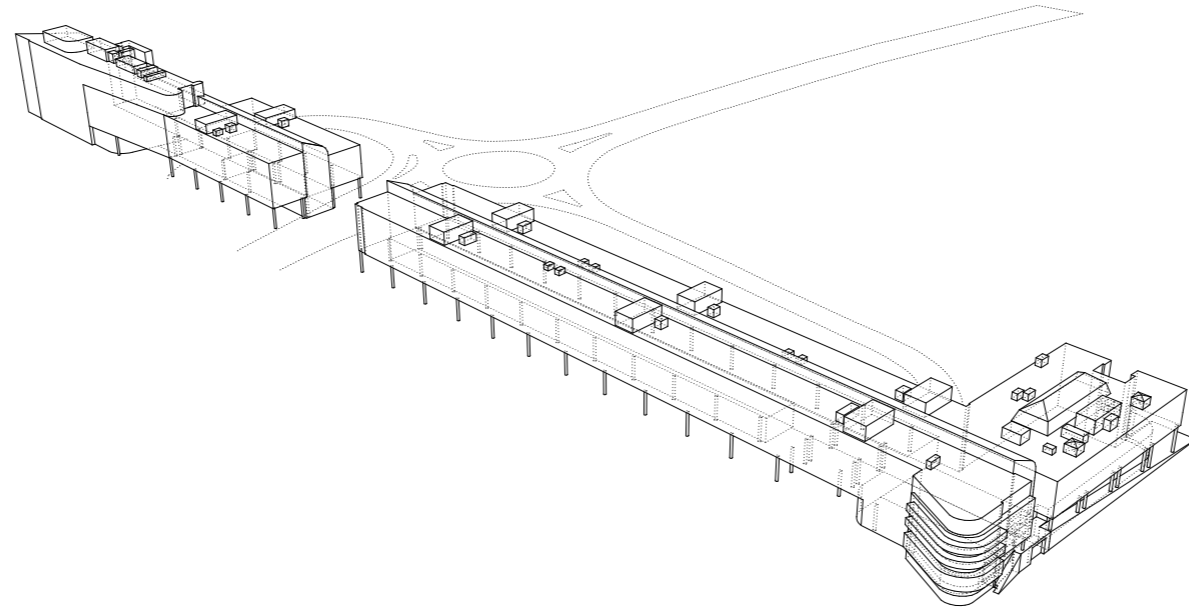

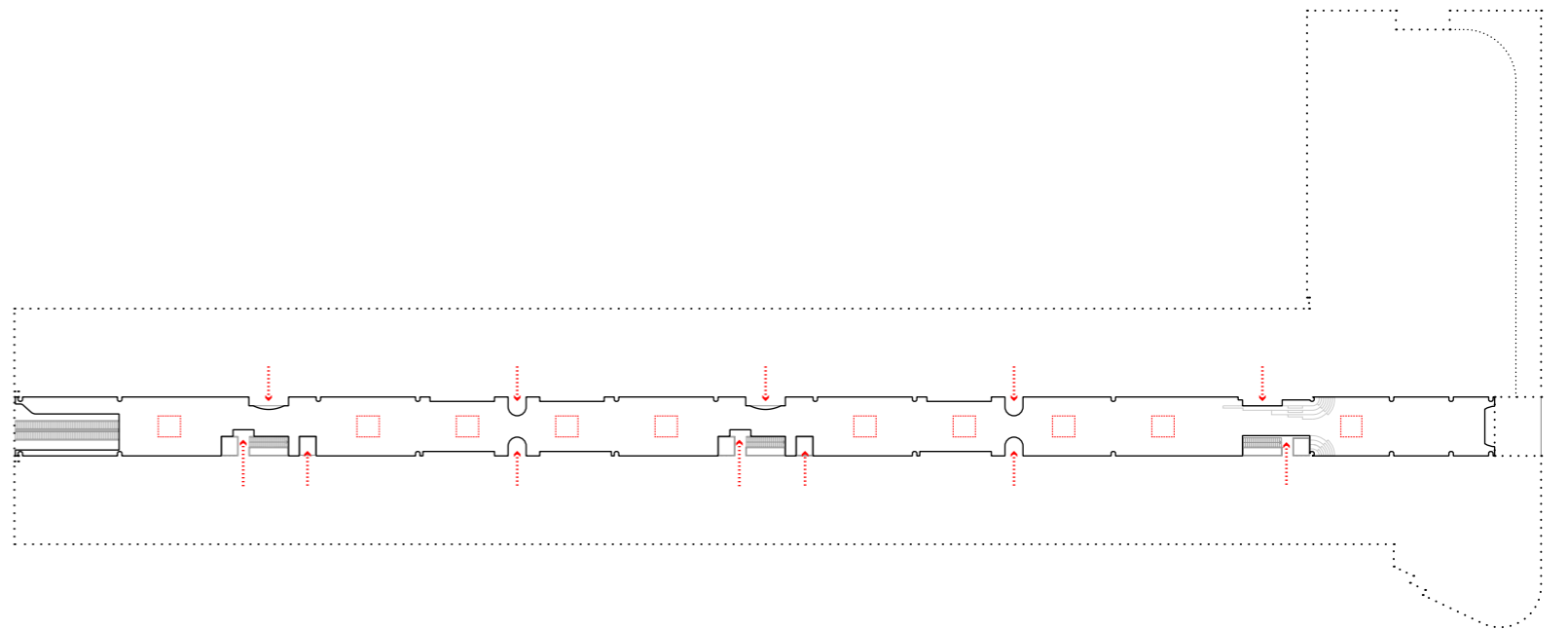
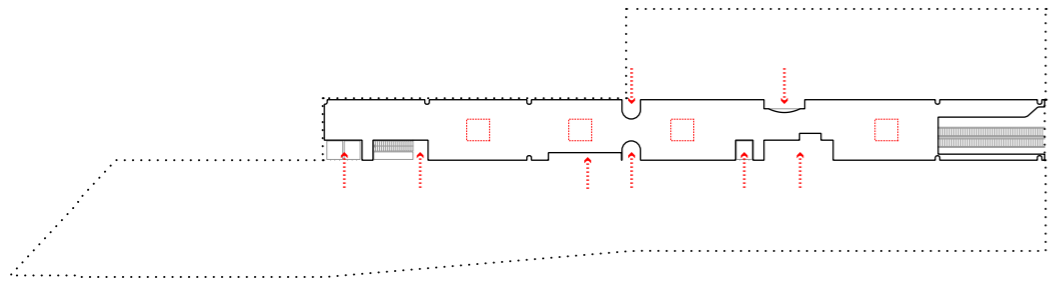
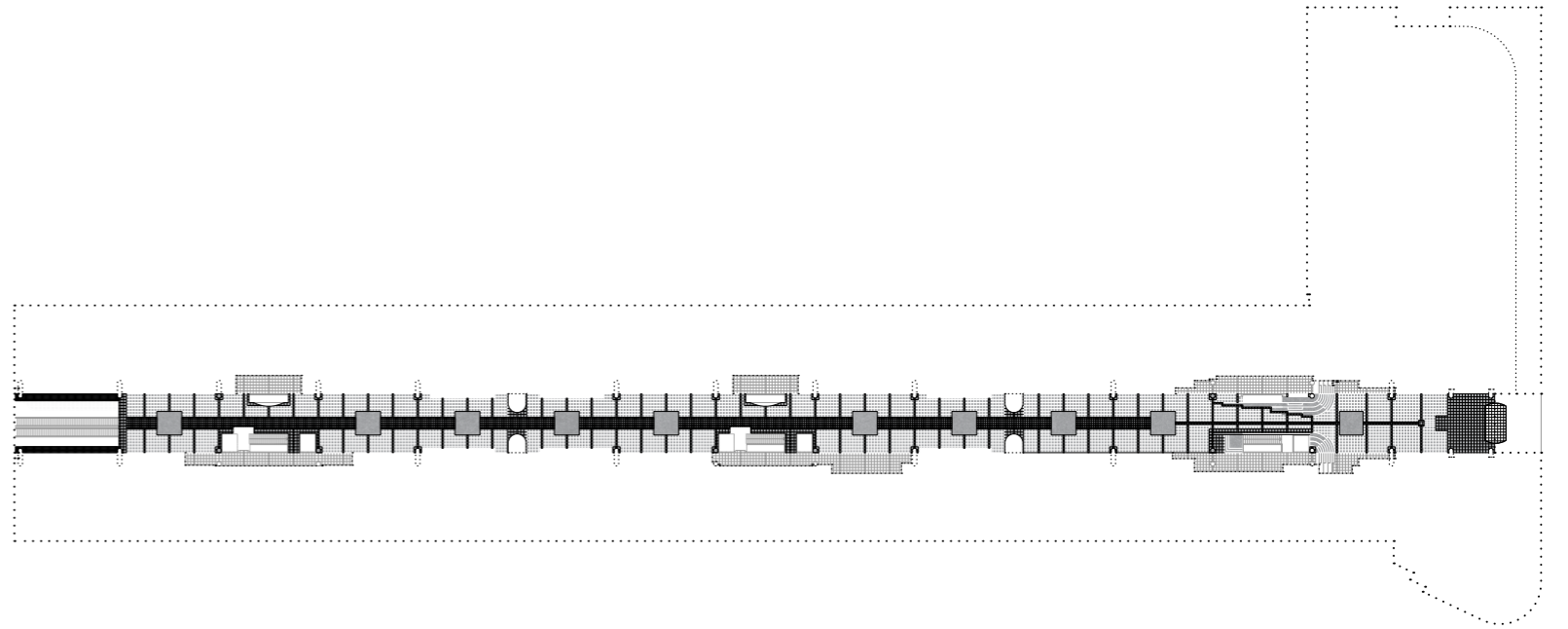
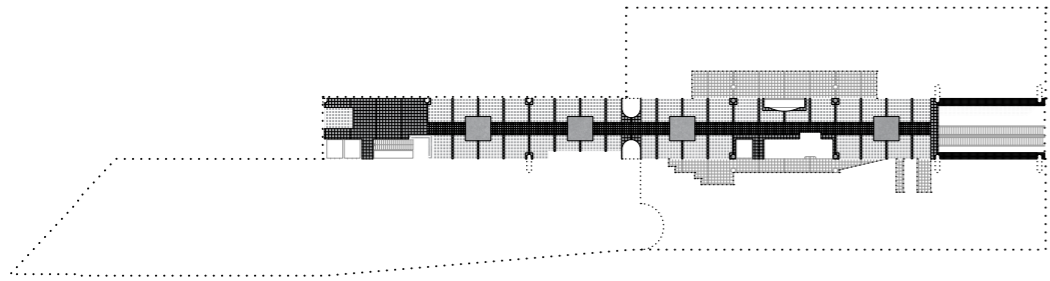

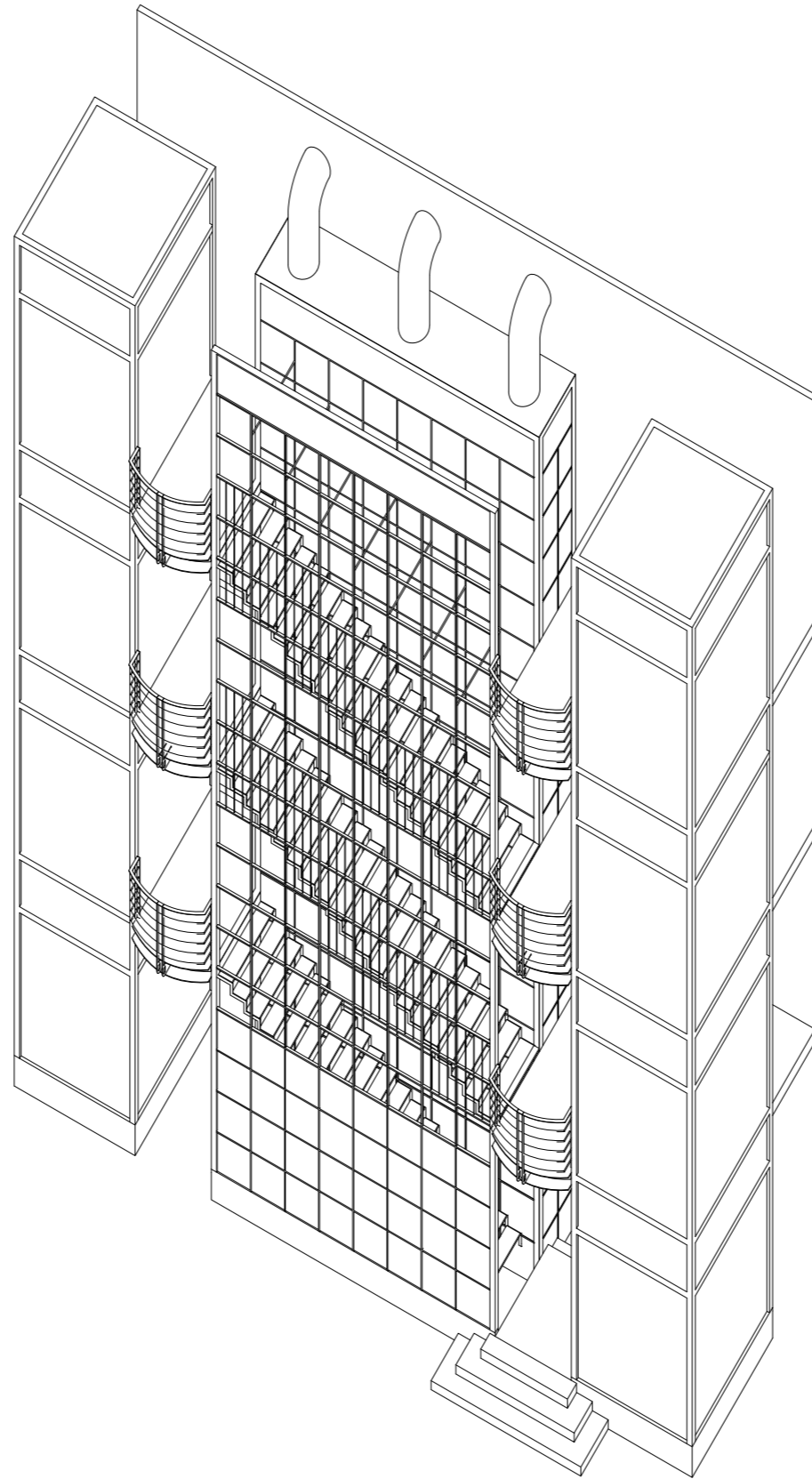

Circulation tower

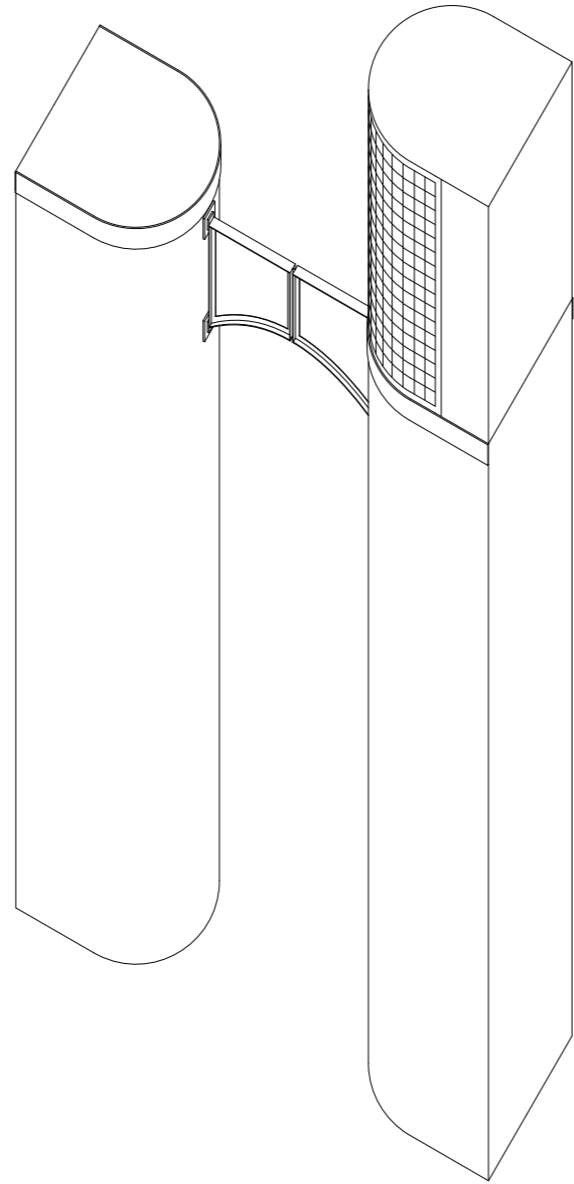

Emergency staircase

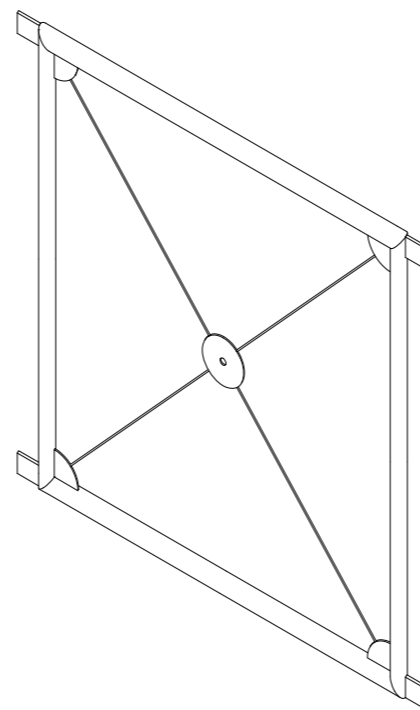

Lateral support frame

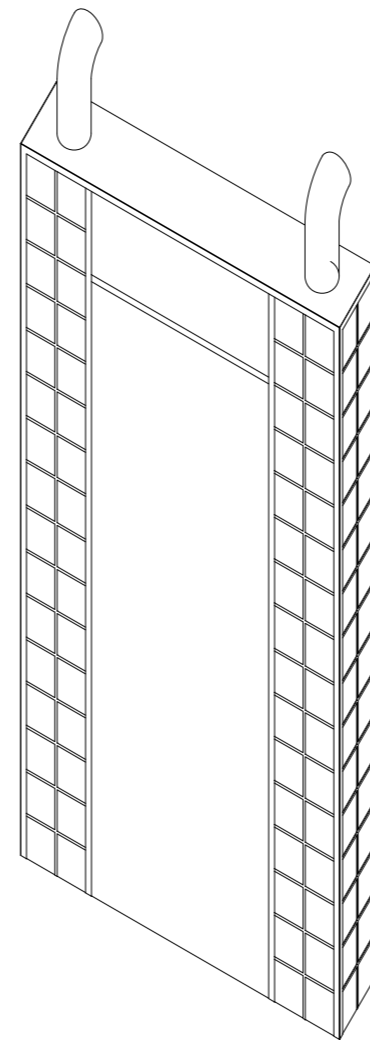

Ventilation tower

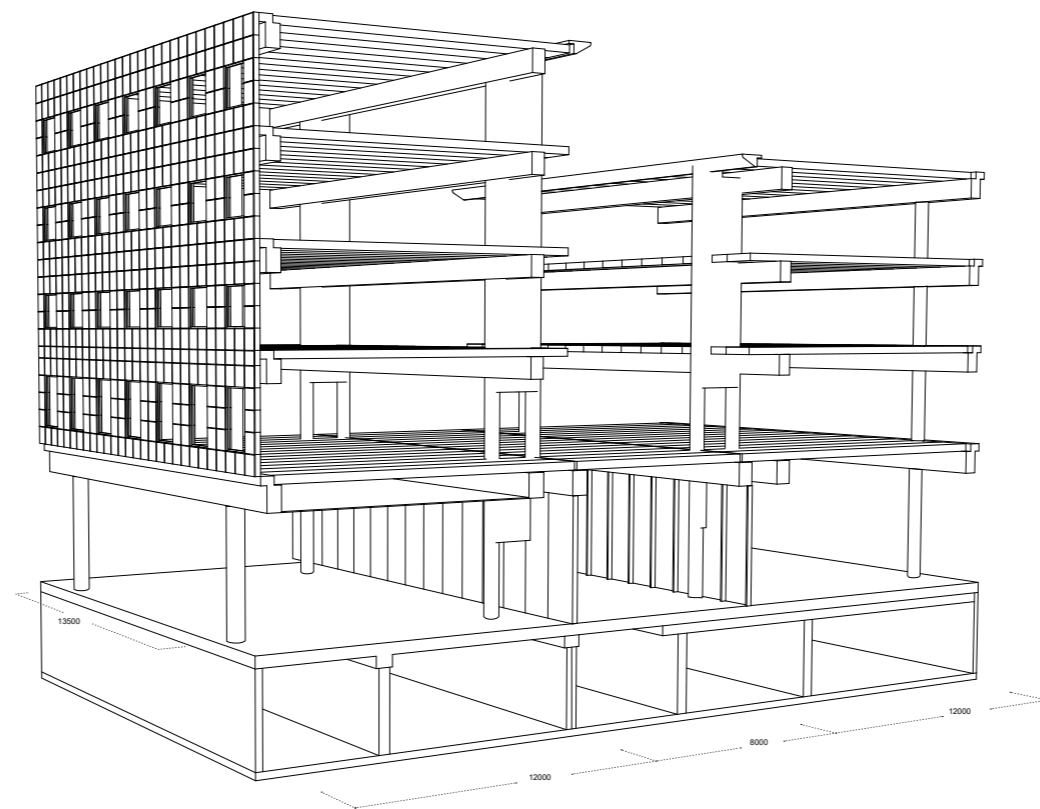

F + 22875

F + 19300

F + 15925

F + 12550

F + 8000

F + 2000

F - 1500

05 Illustrations



Current open floor plan spanning two sections



Floor-to-ceiling glass facade



Floor-to-ceiling glass facade in double height space



Open courtyard in the East Wing



East Wing with atrium



Sand-blasted marble concrete facade elements



Current facade



Current facade

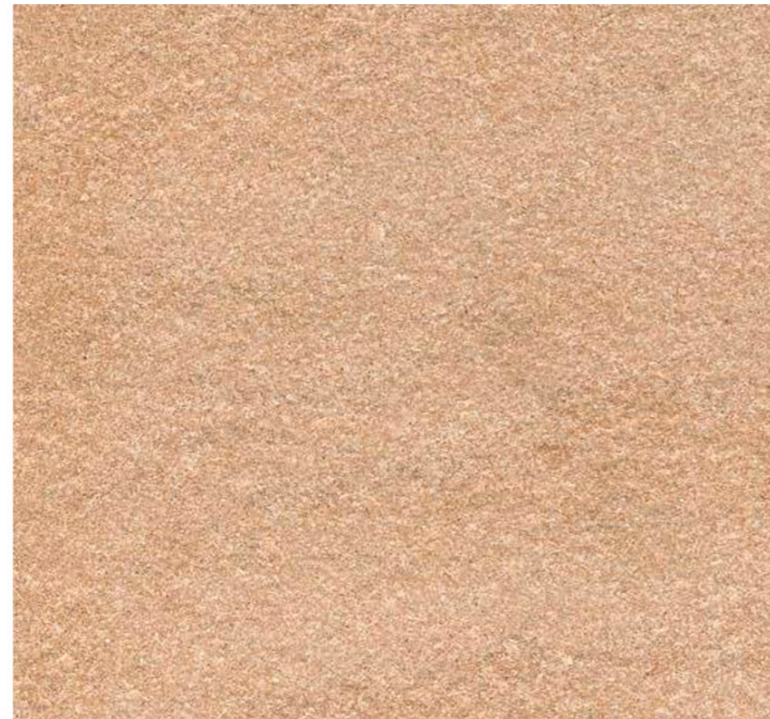

Sand-blasted marble concrete

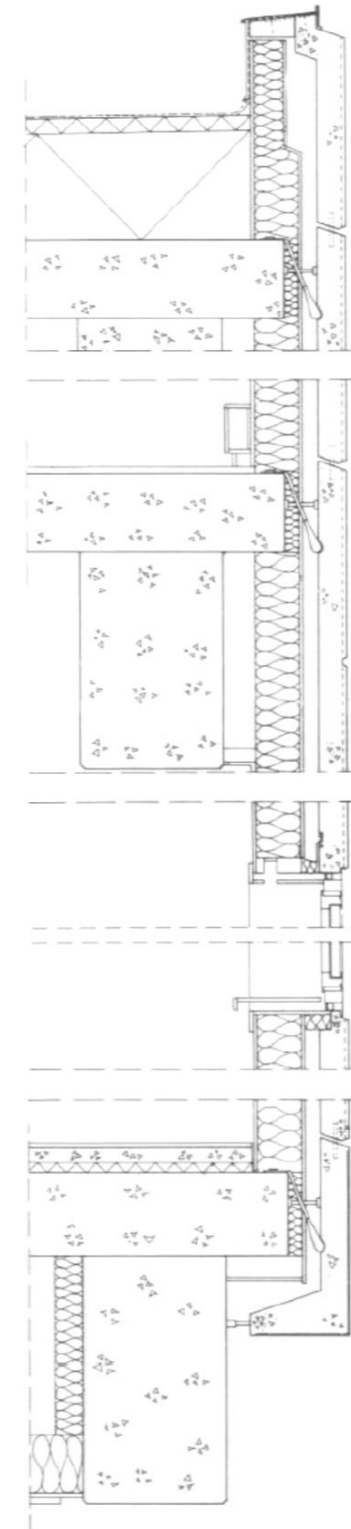

Section through facade element



Bus terminal site in 1959 with slaughter house



Bus terminal site in 1975

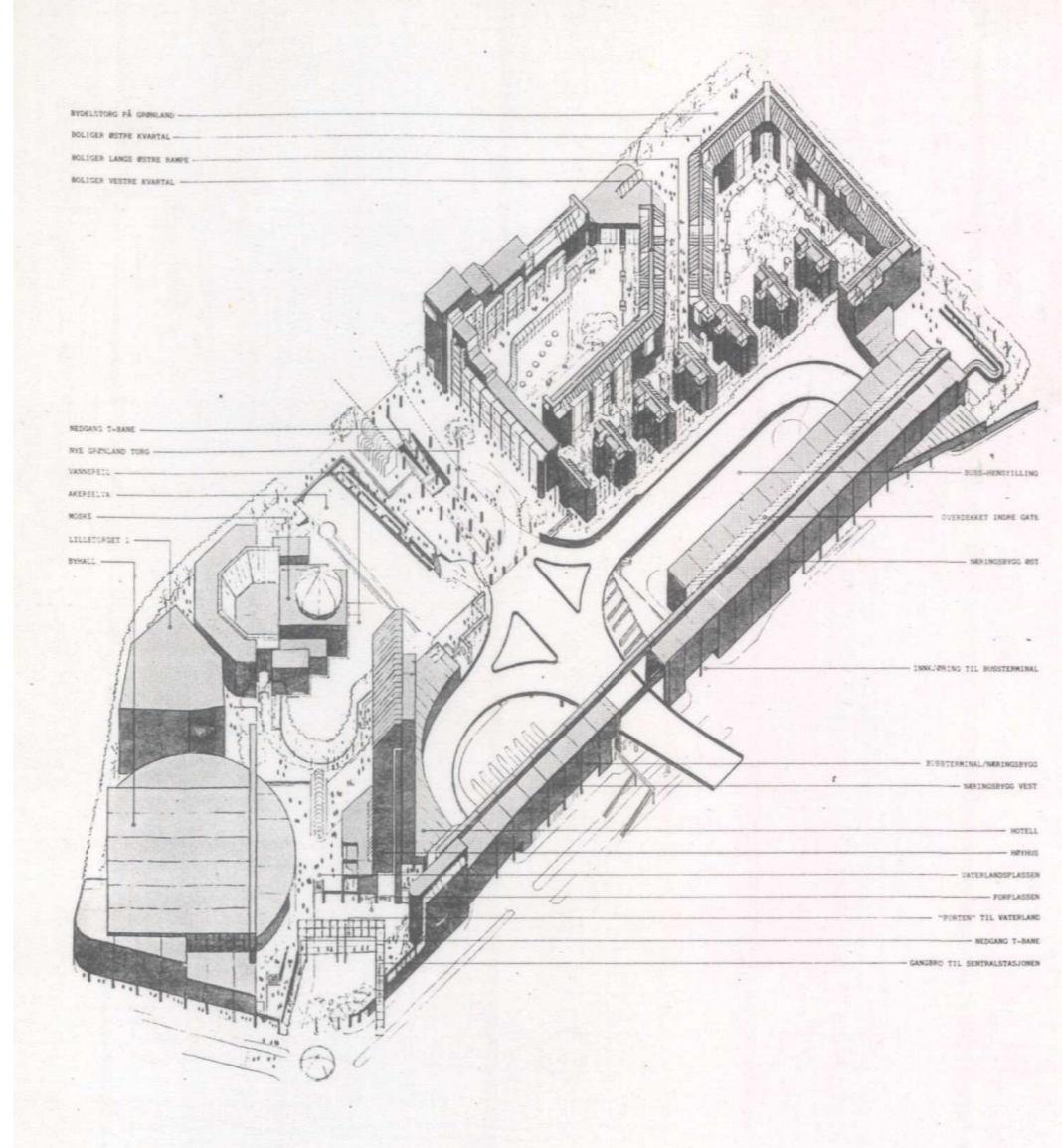

LPOs project proposal for Gronland and Vaterland (1982)

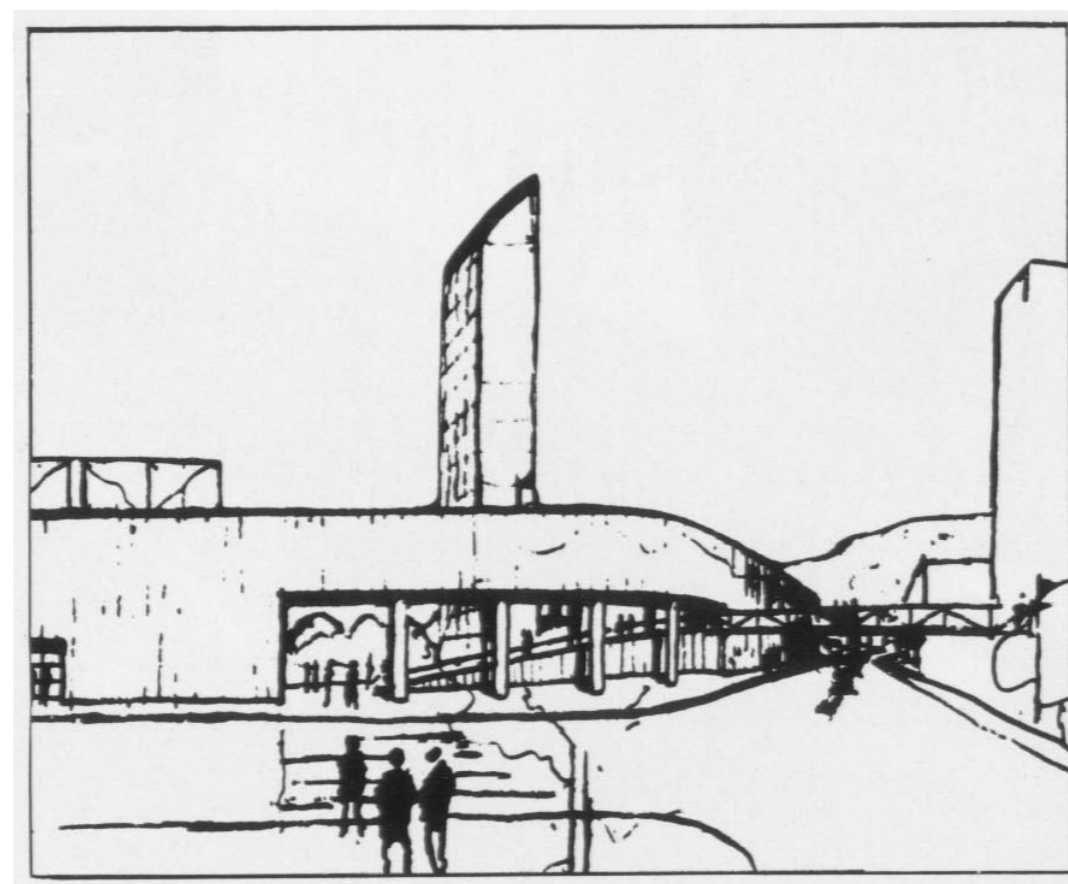

LPOs City Wall project for Gronland and Vaterland (1982)

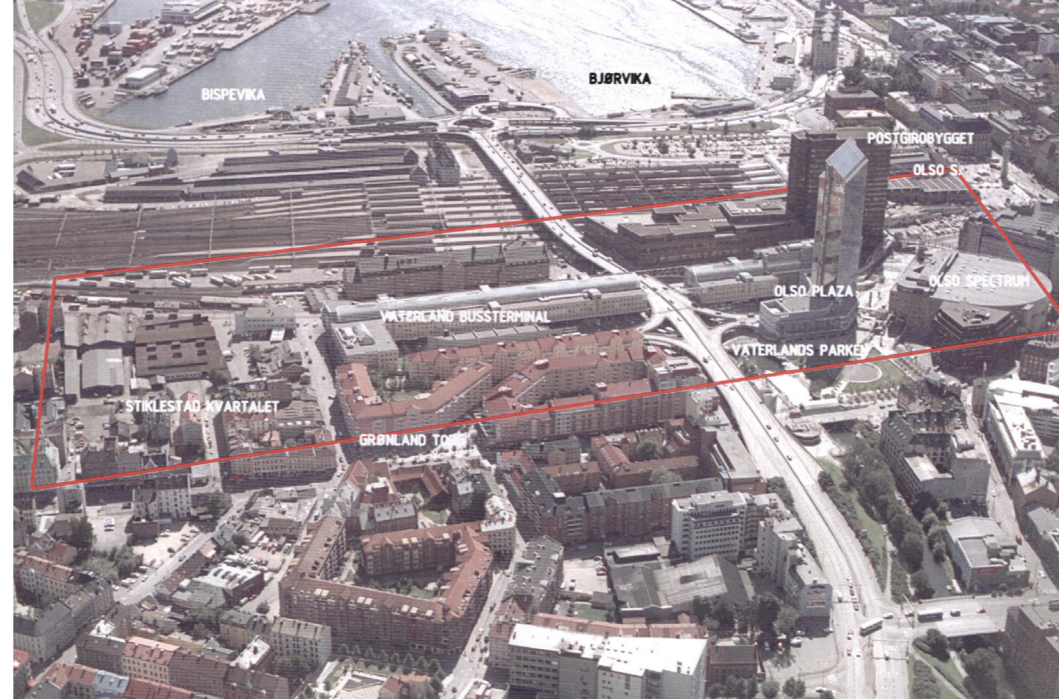

Grønland and Vaterland in 1993

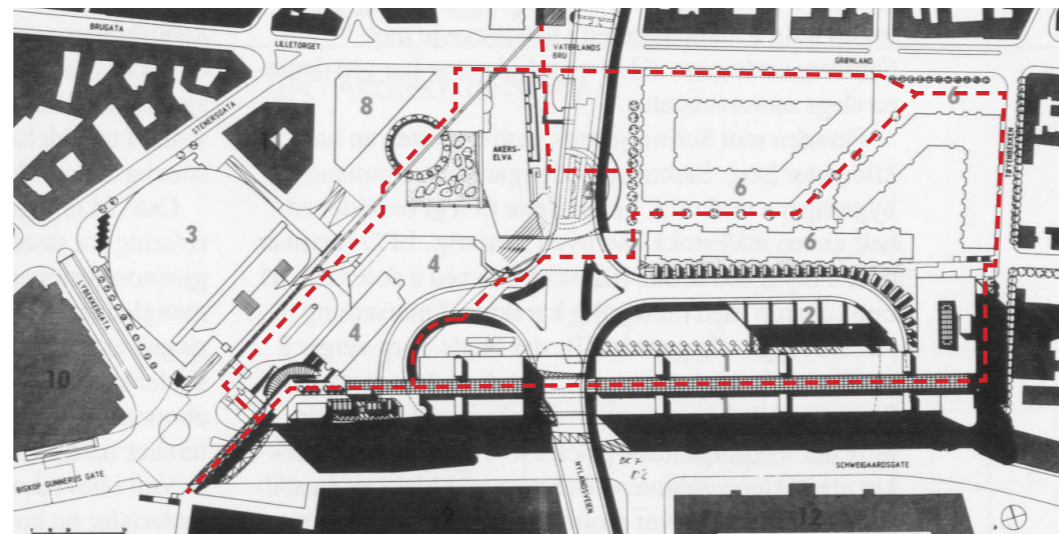

Galleri Oslo final proposal 1987



Grønland and Vaterland in 1993



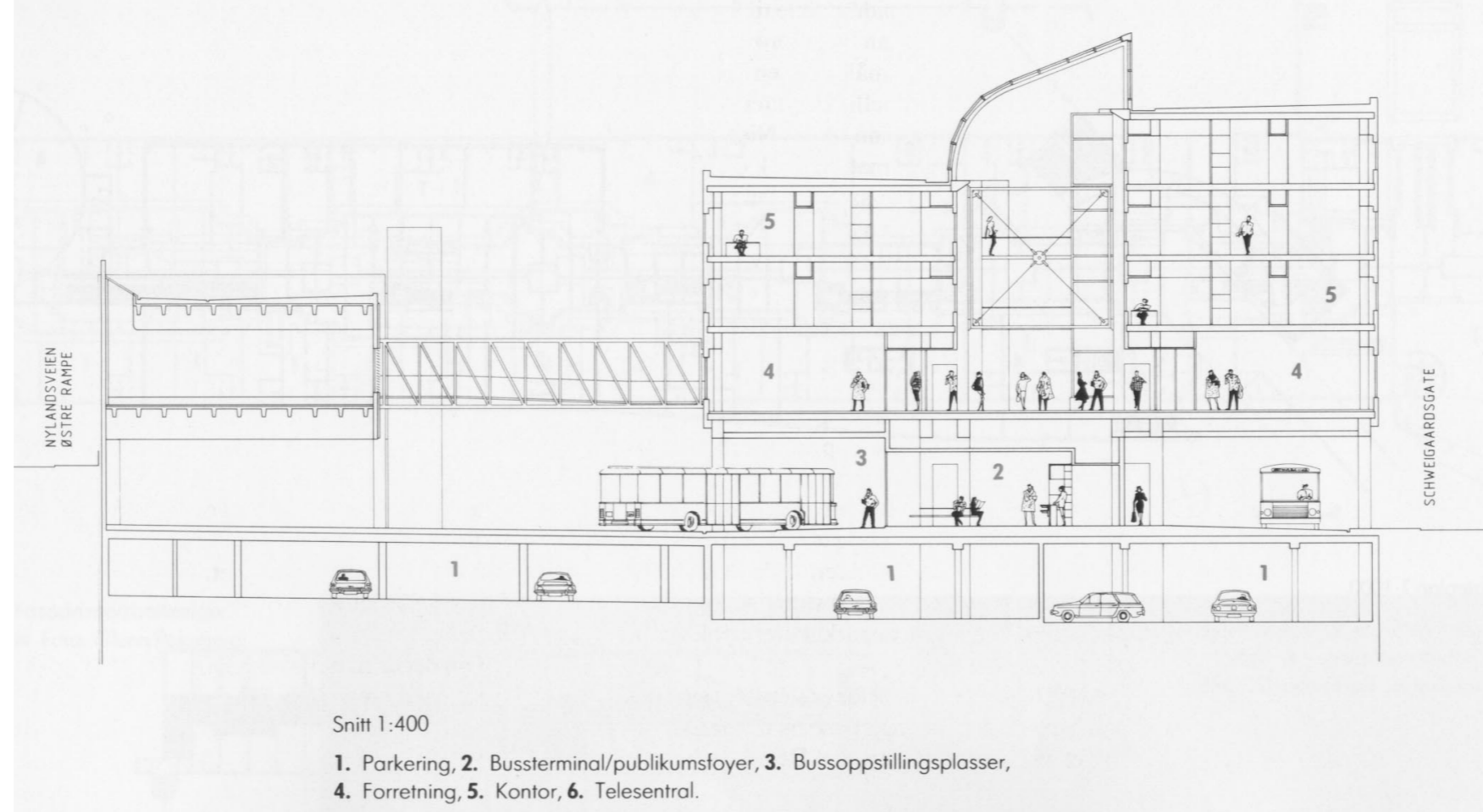

Section through main building and telecom switchboard centre

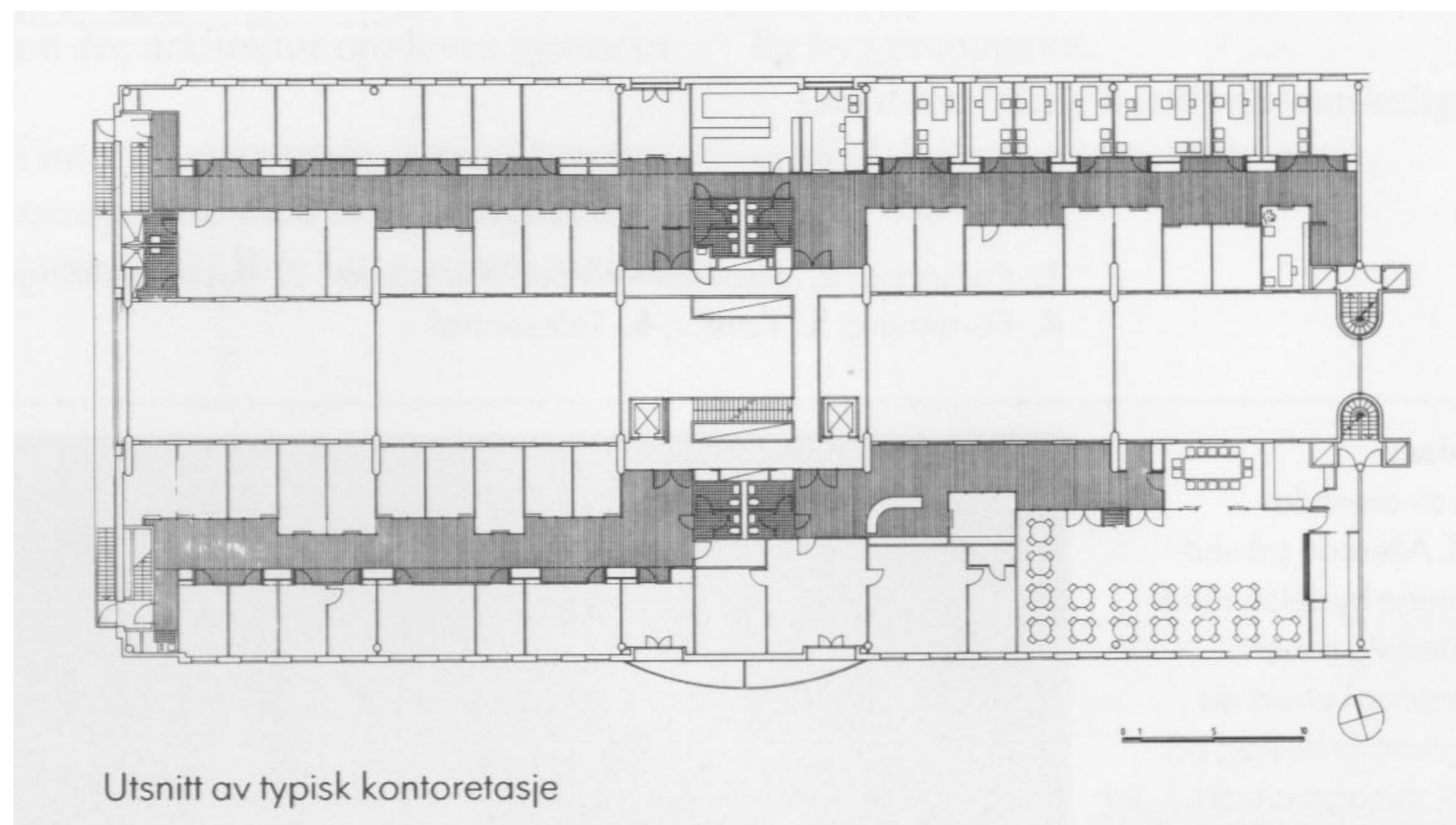

Typical office plan

