

Digital Craft

--Explorations of the craft value in ceramic making



By Chen Xing Wang
The Oslo School of Architecture and design
Spring Diploma 2019

Acknowledgements

I want to express my gratitude to my supervisors: Nicholas Stevens and Mosse Sjaastad for their mentor and guidance.

Stein Rokseth

Nina Bjørnstad

I extend many thanks to the Art and Craft apartment of KHiO, and, in particular,

Sigrid Espelien for allowing me to work in their workshop space

Arely Amaut for sharing her digital fabrication expertise with me

Lina Mariann Friis

Knut Natvik For helping and arranging the workshop for me. And some of the assists when I had trouble in the experiment process.

And special thanks to the class of ceramic and craft people for sharing their knowledge and working with me throughout my entire exploration process.

Contents

	1
//Abstract	8
//Executive Summary	10
<i>The Context</i>	12
<i>Goals and Scope</i>	14
<i>How I have done in this project</i>	16
<i>Main process outcomes and contributions</i>	18
//State of the Art	20
<i>Digital Ceramic Crafters</i>	25
<i>Related Tools and Software</i>	26
//Field Study	28
<i>Expert Interviews</i>	36
<i>Summary</i>	40
//Possibilities Illustrations with Digital Design tools	42
<i>Probes</i>	43
<i>What else might be tracked? - Workshop</i>	52
//Data × Object - Possibilities with Creative Extension	54
<i>Informative Objects as Probes</i>	56
<i>How to inspire craft people?</i>	69
//“Collective Thinking Programme”- Possibilities as	74
Medium for Storytelling	74
<i>Crafted Objects as Narratives</i>	78
//Concept Development	78
<i>Crafted Object as Narratives</i>	80
<i>What’s the Next?</i>	93
//Reflection	94

//Abstract

My exploration process evolves from illustrating out the possibilities with the digital tool to support ceramic craft people's creative work to envision digital tool as a storytelling device.

As a designer who has no prior knowledge about ceramic craft, and the ambition was to cross the parallels studies the intersection between the ceramic handicraft and digital fabricating during these four months. This is almost an impossible task for the designer to accomplish. Since ceramic craft is very difficult that takes years to learn.

*My design approach contains mostly learning by doing things and exploring the **digital design possibilities**, which ends up depicting these possibilities. Inspired by openness and sharing culture in the craft community. The content of the report and the sharable scripts will become the learning materials, which is more about **thinking what value should be carried out when alternative digital fabrication techniques (like 3D printing) spread so rapidly**. Similarly, those digital programmes should act as a kind of material and sensation that customized to craft people's needs.*

*This project also evidenced some of these possibilities of **exploring the potentials of data to enhance crafters' productive and creative works**. By **working collectively with crafters** coming out with some physical objects, **examine a new way of incorporating digital tool in exchanging knowledge between design and craft** to further **define a more nuanced definition of the craft value** in the digital age.*

//Executive Summary

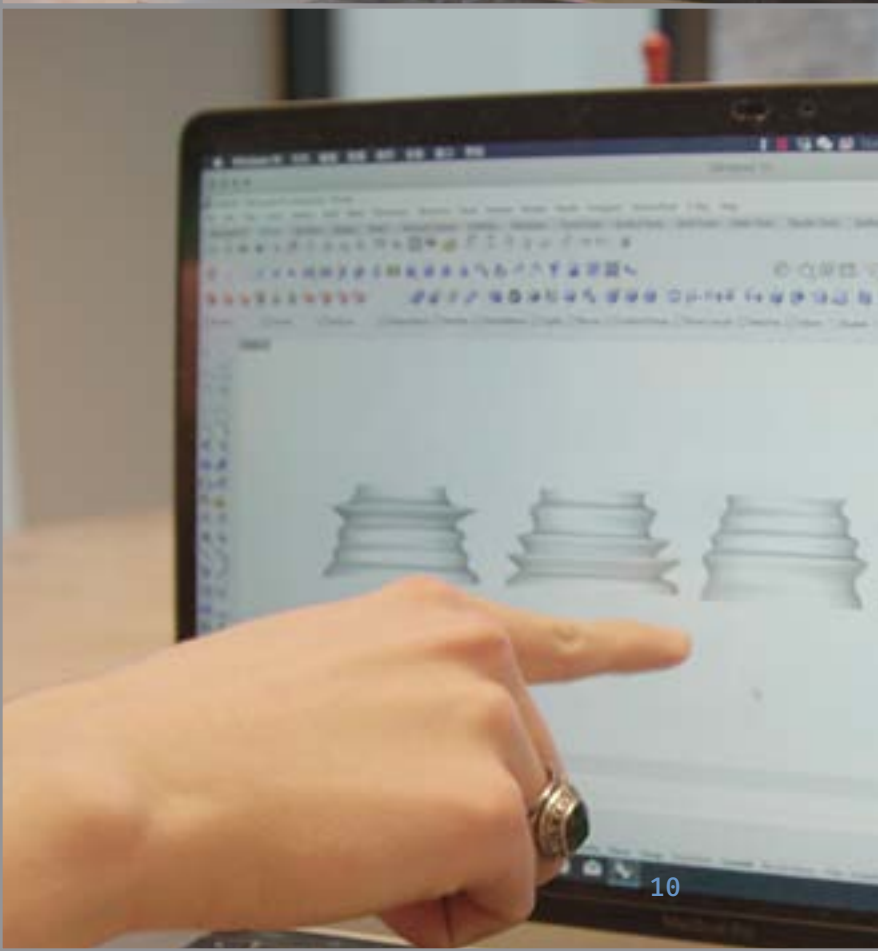
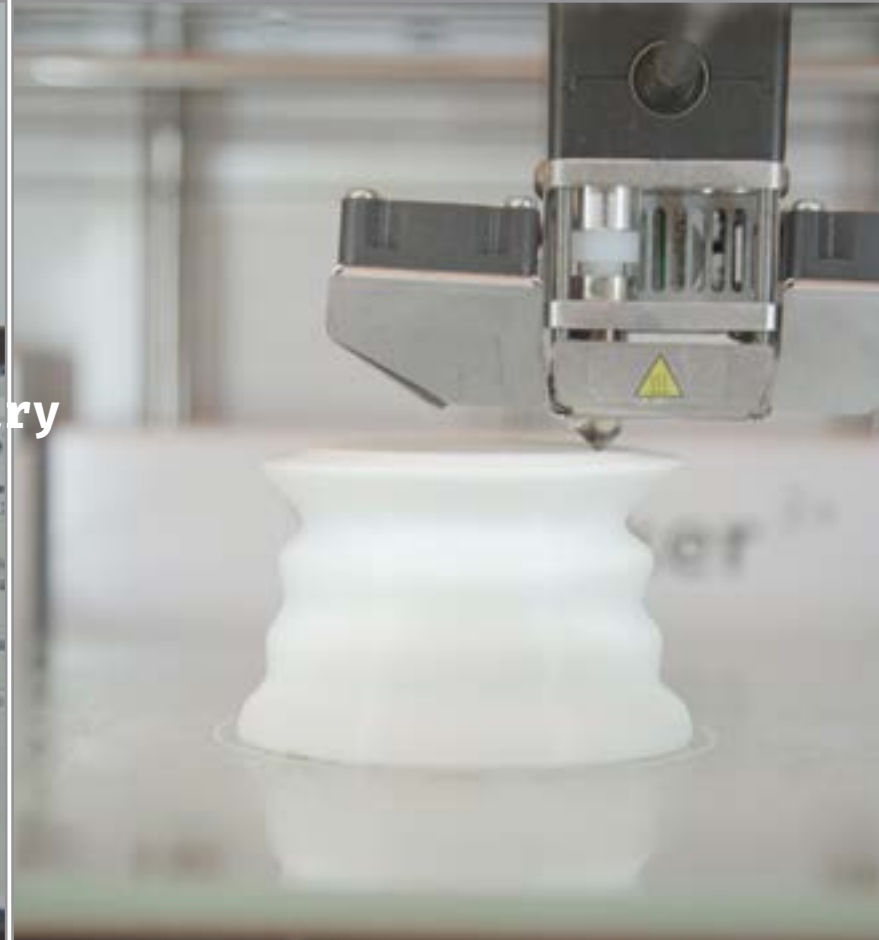

//The Context

Ceramic making, the human being's one of the oldest craft traditions, similar to the other crafts, which its the legacy of people made manifest. Craftsman's making skills and tacit knowledge are placed in the centre of its diverse fabrication techniques.

Although now the wheel-thrown pottery considered an artisanal skill, back in the day of the invention of it was to make the low volume production more efficient. Comparatively, if embracing digital design and fabrication technique and adopting into the traditional craft might mean another round of transformative trend shaping the productivities. Whether one day, it would also become an artisanal and intimate technique or even being closer to human's hands?

*This explorative project is intended to seek the potential artisanal value of digital fabrication by looking into the alternative use of the digital tool in low volume ceramic making. Finally, **interlink the often disparate process of physical prototyping with the digital tool in a way that creatively and collectively reinforce both physical and virtual mode of Making.***



//Goals and Scope

Throughout this project, I will be experimenting with the CAD program(See. Exploring Design Possibilities With Digital Tools) Rhino and its plugin Grasshopper. Through sharing my findings and potentials using scenario. My goal is to:

- Simplify complicated digital design tool to those craft people who are intended in looking for creative opportunities from that.
- Co-operating with craft people and introduce the technique and its potential in being incorporated into their practices.

My challenge in the early stage of the project was to explore and define the design possibilities through practice-based research(see, Ceramic Digital Fabrication) in low volume ceramic making industry, both getting insight from 3d printing and the others fabrication techniques. At the end of the project, I synthesis my findings, and reflect on process knowledge that I learnt from working with craft people, **came up with some alternative use of CAD programme, in addition to various scripts in appendices, which are intending to share the knowledge to ceramic crafters who is looking for possibilities in digital making.**

//How I have done in this project

In the early process of this project, I wanted to investigate both analogue and digital making techniques. **In which what role might the drawing programme play when it works together with handicraft.** The goal is to give value to the collective making process beyond the end crafted objects.

Benefit from working together with both ceramic artists and digital fabrication expert, I gained a deeper understanding of the craft value from both sides in the context of ceramic making and **examining the possibilities and limitations of the CAD programme.**

The exploration focus was on how might I empower craft people work creatively with CAD tools. **The investigations cover from productivity, creativity to storytelling.**

Meanwhile, **the main incentives have adjusted from introducing a digital tool that requires a high learning curve to explore and demonstrate the opportunities of the digital tool with the craft artists.**

Even though there were key questions that had been asked throughout the project: *Who might be the user of these techniques? What might they use it for? How might they use it? What is the benefit they might get from using it?*

These questions have been placed as the core of the exploration process. Personally, I believe that designers and craft artists should continue developing and facilitating the evolution of craft. **Perhaps the best way of achieving this is through developing the knowledge from practicing with the tool and keep reflecting on the production process.**

//Main process outcomes and contributions

*In this diploma, I **explored possibilities in CAD programme and examining that with arts and ceramic students**, testing and failing, holding workshops and conversation with craft people.*

I decided to focus on the contributions instead of introducing a finished product. By sharing my process knowledge and scripts from my experiments, a series of objects is produced. Those objects produced during the process should not be judged as designed objects, but rather as evidence of the potential of the illustrated explorations.

*I hope my practice would lead an example that inspire people to **start reflecting their working process, even challenging the knowledge from the outset and encourage more creative experiments between design and craft.***

*This project aims to contribute to a more nuanced definition of craft value **through collective practices, both human to machine and human(craft)to human(design).** Those elements are evidenced by the end objects and those producing process.*

//State of the Art

<quote>

'The real problem is not to adapt machine production to the aesthetics of handicraft, but to think out new aesthetic standards for new methods of production.'

—English art historian: Herbert Read

</quote>

Digital Ceramic Crafters

*This chapter includes those who I define as “digital ceramic crafters”, from artists, hackers and makers working closely with technology and pushing the limits of existing digital fabrication techniques by integrating the alternative fabricating approaches into ceramic making. Exploring creativities within the largely overlooked intersection area where craft and design(digital design and fabrication) meets. **Emerging analogue input, tailoring an interactive system as an alternative drawing programme with public engagement, Prying apart and hacking the 3D printing machine**, so on and so forth. Intending to draw a rich territory for analogue and digital collaborative fabrication to further define a more nuanced definition of ceramic craft in the digital age.*

//Unfold Design Studio

Studio Unfold was found by Claire Warnier and Dries Verbruggen, which develops projects that investigate new ways of creating, manufacturing, financing and distributing in a changing context. As their one of the notable project 'l' Artisan Electronique', shown in (figure.)



Exploring a potential future for the development of craft, the user can throw a digital vase bypassing the hand through the laser to modify the shape in a virtual pottery wheel interface further. **It intended to take what is good about the old from the wheel throwing, allowing crafters to push their discipline into realms that are unobtainable through traditional making, rather than aiming to create an entirely new tool.** However, it completely **lost the notion of that act of creating artefacts with the intimacy of the materiality.**

//In-Flexions Design Studio

In - flexions design studio's "cutting edge" focus on **customizing existing digital tools as a mean of creating new ways to design or modify objects.** This implies a shift from **conceiving unique objects to developing interactive systems where end-user can produce their objects.** "Cutting edges" aims to allow the public to easily "design" a plate collection using a template on a tablet, shown in (figure.).



//Olivier van Herpt

Olivier van Herpt is a designer and crafters whose work soften the Precise and indifferent definition of digital fabrication. His work with 3D printing and clay, **introducing elements of human touch, and random imperfections, and shaping pottery by the environment, all these manufactured artefacts demonstrate how he reinserts humanity into the machine.** For instance, his “sensory machine”, shown in (figure.) external information was measured by the sensor, eventually translated into the specific behaviour of the printer. The designer was selecting and distilling certain parameters from the complex environment makes into a document of a specific time, location with the raw materials.



//Jonathan keep

Jonathan Keep has developed a digital design and fabrication workflow, which using computer code in processing formate to generate the shape. shown in (figure.) Jonathan Keep’s series work, some elements of the ‘icebergs’ and ‘sound surface’ series were drawn inspirations from nature.

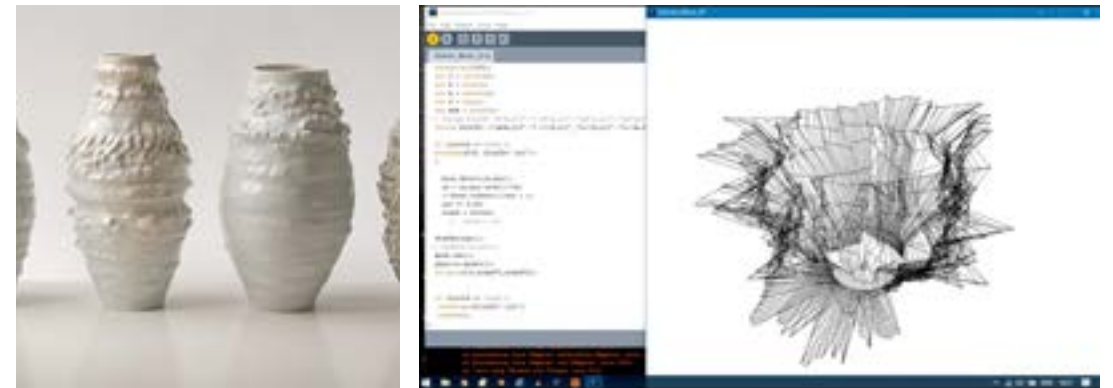

Standing on the 3D printing realm as a creative practitioner who is **intending to make traditional makers aware of the creative possibilities in computer-aid technology.** However, There are many practical barriers to novice participation in this domain. His informative digital design level of workflow informed my exploration direction and gave me inspirations on investigating the aesthetic and impact of digital making through **explicit the process of digital design to fabrication.**

//Related Tools and Software

I made ground studies at my early stage; I identify several services provider that is relevant to my project, bringing a digital design with craft to enhance their self-expression and creativities, which is of coverage of these study areas.

- Enter level design app with intuitive, customizable functions empowers creativities.
- Novel digital fabrication tool
- Professional CAD tools. With computational design functionalities.

/*Potterware*/

An intuitive design app for 3D Printing ceramics. Potterware claimed that alleviating the need to learn 3D modelling software by bridging the gap between digital modelling and silencing programme anyone to design sculptural or functional pottery. Features with easy to use sliders and printable files download directly to your laptop, which allows novices to unleash the creative potential in 3d printing clay.

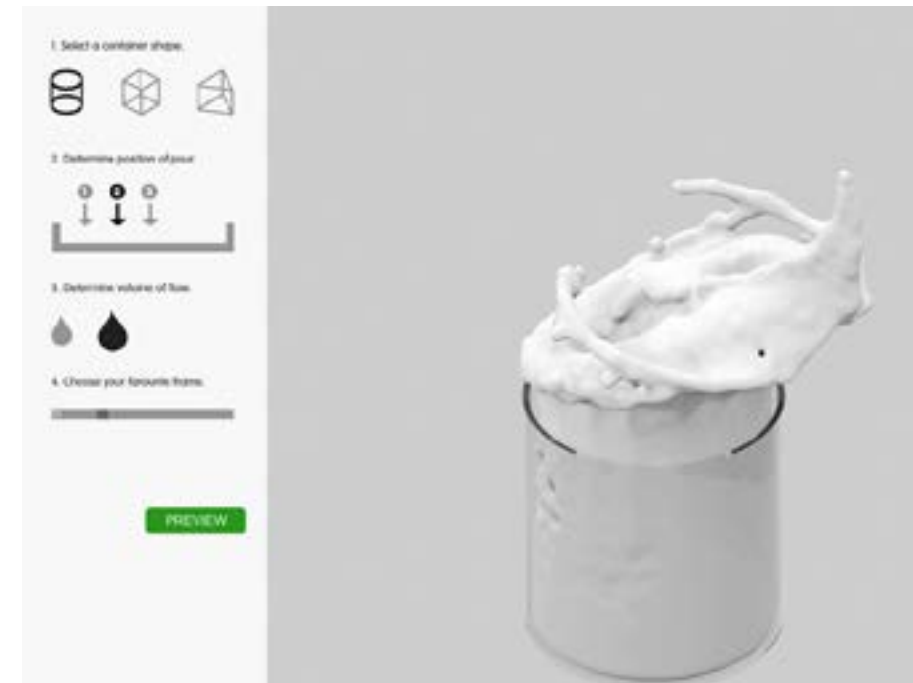
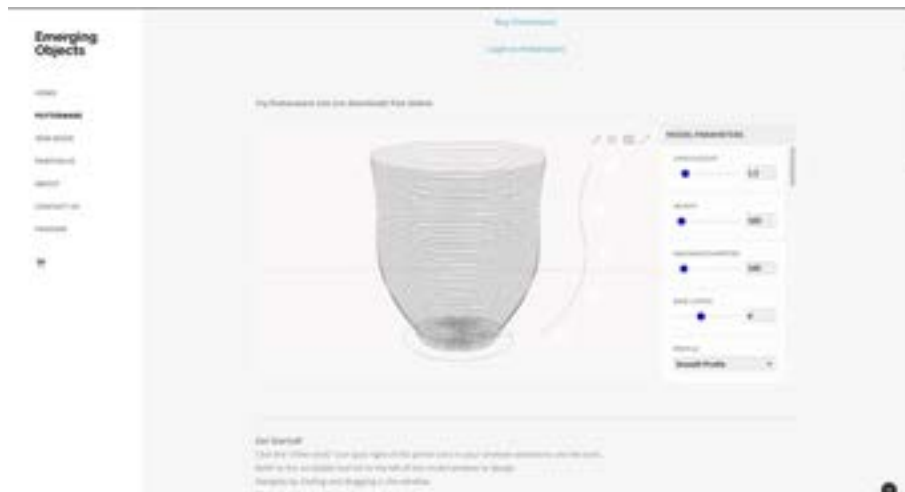

/*FluidVaseInterface*/

The Singaporean designer Fung Kwok Pan has managed to capture the flow of water in solid form which produce the unique object but with highly easy to customize capability, which also allows users to experience a certain type of uncertainty

/*opportunities and challenges*/

It is worth mentioning that these digital tools all move the actual hand-making away from crafters. The challenge here is that craftsmen still need to take control of the process of the close connection between hands and materiality, but still allowing them to make digital tools an extension of their creativity.

//Field Study

Expert Interviews

I spoke to people whose work related to ceramic low volume production, ceramic hobbies, ceramic arts and craft students at KHiO, and ceramic artist.

*I intend to render their expertise of ceramic craft with their goal motivations and knowledge. Since my **goal in summarizing the insights** is not to render these people as representative of the wide variety of making techniques.*

*Instead, I hope to convey their considerable knowledge in their field **to have a basic understanding of the ceramic craft.***

*And also more importantly, during their practice, **how do they view the relationship between fabricating technique and the craft value** is also an essential part of the examination.*



//Sigrid Espelien

//Profile

I spoke with Sigrid Espelien, who has a ceramic craft and fine art education background from both Danmark and US. Now she is working as an assistant professor of ceramics art at KHiO.

//The Conversation

/*Technology &Materiality as Storytelling*/

From a ceramic artist's perspective, in part of her long term project *Bjørvikaclay* (figure.) **Reflecting about the fast-growing city area in Oslo.**

She uses **clay as a starting point** for her artist's **practice-based research project**, her use of earth rises from its overlapping areas archaeology, geology, city development, architecture and the industry is in a critical perspective.

Her work which also involves **clay as the beginning for materiality research of digital fabrication technology.** Ceramic 3d printing as part of their producing and documenting process where they were working closely with the local community **using site-specific material as an entryway to the site and its storytelling.**

As(Figure.) demonstrated an art piece using in-site clay to print the site topography.

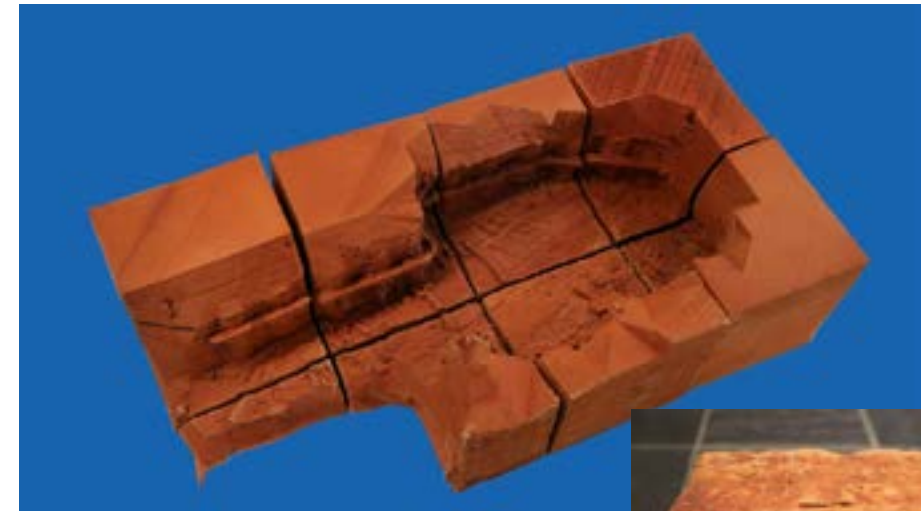

<https://marmuseum.no/arkeologisk-utgravning-blir-kunst>

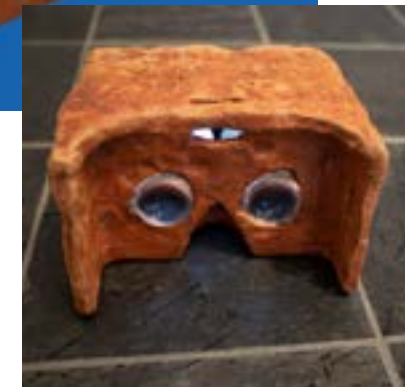

/*Thoughts Sharing and Openness*/

She and Arely Amaut, they built one of their machines in the ceramic workshop at KHiO, they named it with "collective thinking machine." (Figure.)

Their original intention was to share the **creative process of using ceramic printing techniques.** As she claimed that: *I want to use this machine in different settings.*

(site-specific, collaborator)(Figure.) **both that collaboration happened on creative practice with digital fabrication and using as an aid tool for analogue making.** She was committed to democratizing their technology with the material exploration into the public in various forms, workshops, and public exhibitions etc.

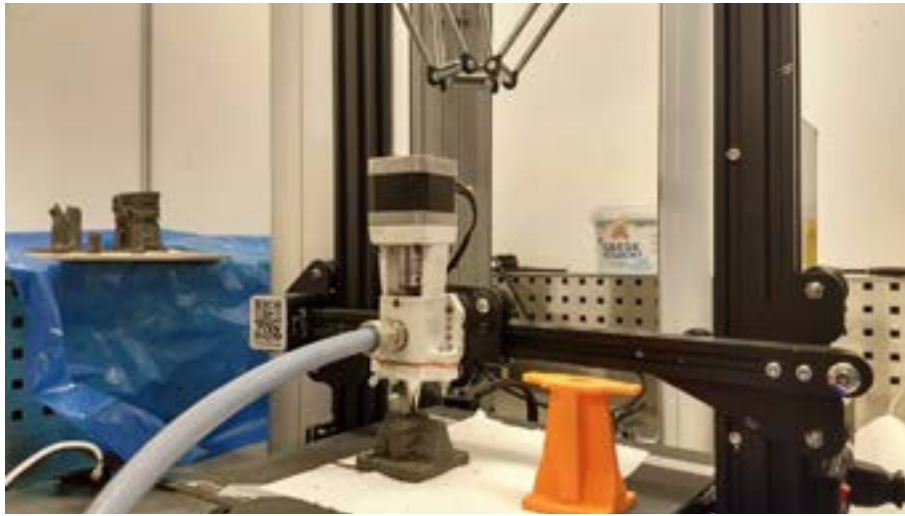

/*Uncertainty Towards Ceramic Digital Fabrication*/

Sigrid came up with the question of if the ceramic 3d printing meaningful?

“Do we need 3d printing ceramic? Does the world need this? What kind of philosophical and Aesthetical questions open up in that process, and one thing is that art object, another thing is production? Where are those possibilities?”

*Her **critical points of using 3D printing reflected on using clay as a biomaterial, rather plastic.** (Clay made extruder and the other different extruder system customized for materiality)*

She continues to say:

“for production of the house it makes sense those people that are printing with clay but making cups I don’t know? But of course, there are a lot of things that have not tested yet, 3d printing Vassel someone did that it is already out there, but for industry what is the next? For like archaeology and architecture, it is entirely different. There are so many different ways of doing it. it can open up into some other various fields.”

/*New Issues of Craftmanship and Technology*/

Sigrid mentioned the working process with the printer rise the new questions of craftsmanship.

As she describes clay and 3D printing don’t quite fit together, she has to sit next to the 3D printer for a whole day and make sure the clay came out the extruder.

Make sure it has the right consistency and does not dry too fast or too slowly. It is not an efficient process, which makes questioned the value of the ceramic 3D printing craft.

What I read from her comments was the inconsistency opinions towards craft value, when it comes to production efficiency and as the medium for storytelling is opposite.

*She is humble for her limit knowledge, she recommended Danish ceramic artist, Anna Andersen who is considering 3d printing ceramic into actual production, including Kristin Andreassen who recommended by my professor Nina Bjørnstad. Although I did not manage to communicate with both of them due to the limit resources I have, which make me **decided to work with Arely Amaut to have a basic understanding of craft value in ceramic digital making and most importantly continue to look for design possibilities.***

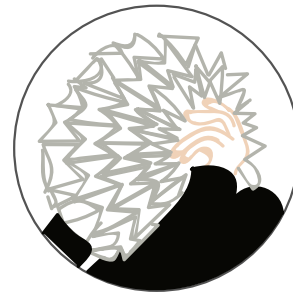

//Arely Amaut

//Profile

Arely Amaut with digital fabrication background is currently a master student in Art and public space at KHiO. Her master thesis is relating to **engaging publics to the participatory process** through art, and how **digital technology** could involve in this process.

/*Working with and Learning From Arely*/

I spoke with Arely Amaut most frequently during the earlier working time at KHiO's ceramic printing workshop, due to there is no workshop manager, she had to be the assistant of clay 3D printer workshop. Arely was **responsible for instructing and demonstrating how to use their own "collective thinking machine" with me, including how to infill the 3d printing clay, install varies their customizing extruder system, change settings, and basic machine troubleshooting.**



/*Experience with Digital Fabrication and Design*/

She describes the **process with continues troubleshooting and problem-solving process**, even with how much experience she is.

She said when she was working with Sigrid for her Bjørvikaclay project. She describes this machine as not built for "production efficiency", The same additive manufacturing but with different extrude material would bring different traits of the practice, **Clay is such a unique material when it comes to 3d printing.**

"You always need to make sure the flow rate of the material is consistent; otherwise you need to pause the printer adjust the flow and then continue, you never know when you supposed to stop the machine and adjust the parameters".

The first test print (Figure.) we did when I had the first visit at the ceramic workshop in KHiO. As parts of their art project use, Arely demonstrated a printing from converting an image format of a slice of Oslo landscape topography with depth information to STL file, modified nothing in Cura and then printing out with Clay.



//Siqi Chen

I spoke with who

*In order to understand where the creativities areas might be during the analogue ceramic making process. To do so I conduct an flying on the wall observations(FOTW) with craft people on our first meeting. Looking into the entire wheel-thrown process. (see **Field Study Expert Interview with Artisan**)*

/*Alternative view towards tools*/

“Intimacy is often a sensorial thing, and crafting is primarily a sensorial experience, you might want to explore that, I think it would be super interesting like if you create tools with soft materials, warm materials, things to touch, feel, create relationship with over time, just like the familiarity of an artisan when holding a tool he has been using for years” if there is a tool would still allow using hands as the most analogue input, but which then is beyond your hands allows you do do something you cannot achieve in normal?



/*Opinion on digital fabrication tool*/

“right now the additive manufacturing has been marketed with a very sleek and futuristic tone of voice.

As opposed to the geeky and do it yourself style that is hard to use and sell to the most of the mass, but I think there is a gap here, what if you create a new type of tools to command/collect/generate data for the digital means to follow? What would that be?”



artist and hist hand build work

/*Video sketching*/

I did video sketching to backcasting the first observation with the ceramic artist, filter out from massive information and search for opportunities from video editing and backcasting, and finally focus on the fine operation of the artist's hand and the consistency in the producing process. he often mentioned. He needs to maintain the stability of the hand movement at all times to maintain the product quality in massive production process.



//Summary

After the hypothesis of the findings from the field study and the summary of state of the art research. I came up with even more questions.

How much of the value of the ceramic handicraft object in relation to the hand? Does the intimacy of tool and “hands” still matter? In my mapping activities, I identified several practising from what I named as ‘digital crafter’ who focusing on facilitating the evolution of craft, took digital fabrication as their enhancement of the artisan’s hands, pulling out the traditional craft elements and embodying human factors into new type of digital fabricating.

<quote>

‘The real problem is not to adapt machine production to the aesthetics of handicraft, but to think out new aesthetic standards for new methods of production.’

—English art historian: Herbert Read

</quote>

Possibilities Illustrations with Digital Design tools



/*Probes*/

No matter how accessible digital fabrication facilities is, most of the ceramic art students in KHiO I got in contact with at the early phase of the field study stated that when they think of “Craft” they tend to think of the hands and their connection with the material and the process of sculpting. **Their common view regarding “Craft” is it is completely separated from “digital” and computation.** Although I mention some ceramic artists produces craft with computational tools and digital fabrication means (see *State of the Art: Digital Ceramic Crafter*), very few artists highlight their crafts are done with digital fabricating means involved.

Very few workshop participants mentioned they **used the digital tool(digital fabrication and its workflow) as a means to create or to assist their work.**

Some workshop participants with basic digital making experience like to talk about the difficulties they encountered when they were working with digital tools. One of the participants described her experience crafting with both digital and analog means as such: “One of the experiences I had with digital tools was doing 3D scanning on a piece of artwork, printing the digitally altered craft back, modifying the craft with analog means and repeat the process. I had to **go through a lot back and forth between digital and analogue at different phases.**”

Nonetheless, workshop participants liked the idea of incorporating digital tools in the crafting process and are open to try it out. They were wondering about how it could be done. For example, one of them mentioned “**I would like to see if I can somehow measure the process and then reproduce the ‘hidden’ process by applying the data.**”



Video Clips

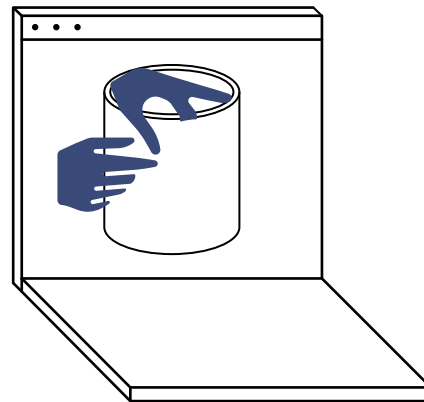

(Example Scripts see: Appendices)

After uncovering the craftsmen's expectations, the challenges and opportunities, **I started exploring with the digital tool and illustrated the potential ways of incorporating digital fabrication means in analog ceramics crafting processes .**

/*Hand-E-Craft*/

WHAT: The first probes I did was by **creating a technique for tracking and collecting craftsman gesture movement.** Working closely with ceramic artist, using leap motion sensor and camera to record the data of his hands' fine motor operation, eventually, these movements were real time transformed into 3D CAD (rhino)software as digital data showing on the screen. Allows **these input data being able to be preserved for further preservation and reproduction use.**

WHY: What I wanted to test **identifying and documenting their creative process by tracking their hand's movements as well as the possibilities of creative use of the digital tool might inspire to reflect on their working process.**

Merging handicraft within the digital sphere opens up lots of possibilities and opportunities to **empower craft people's both productive and creative work.** The next subchapter will show how I illustrated out the possibilities of this digital tools by working with craftsmen and outline those areas where they might be further implemented into their future of work.

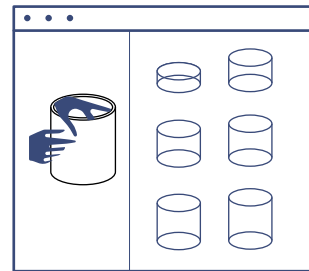

(Example Scripts see: Appendices)

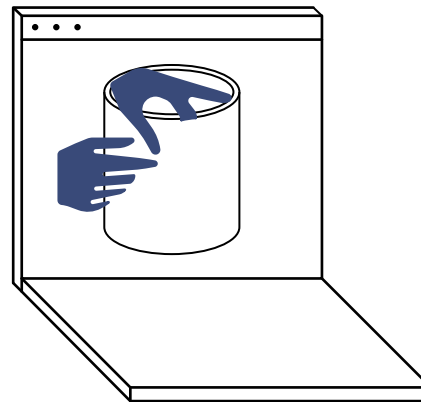

/*Process Recorder*/

<quote>

Within a traditional process, the maker is engaged in the complex process of judgement, dexterity and care. The crafter make a series of personal decision that defines the object, yet at the end, unlike a ‘digital craftsman’ they have no way of accessing the history of their decision. The only documentation of their end outcome is the object itself. Whereas, a digital object has with it an accessible and editable history, which considerably lowers the risk associated with it makings.

--Academic and Designer Amit Zoran

</quote>

How we view **the process and its association with the making of objects is integral**. During my first observation trip at the ceramic community in 11 September (see Field Study: Expert Interview), what astonished me about this whole episode of the wheel throwing was how complicated a process is with such “obvious” of the outcome the craftsman was throwing a small cup, The man making this was unquestionable skilful in his almost choreographed performance was attracting me the most. It was the process that was interesting, with the actual objects not being seen on their right, but more as a reminder of the process you had seen.

I set out to test with one of the ideas. Assisting with the digital tool, **I record crafters’ history of hand-making which store as an accessible and editable digital history** allows them to backcast and sort out specific steps and then later printed it out or use it to make the mould for their rapid production “because sometimes you do need to balance between the consistency of quality and the enjoyment of hand-making during low volume production.” As craft people described after his intensive wheel throwing production for the coming Christmas market.

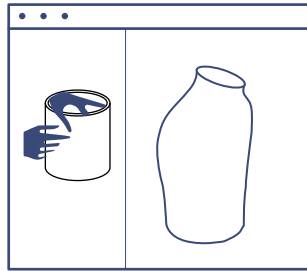

(Example Scripts see: Appendices)

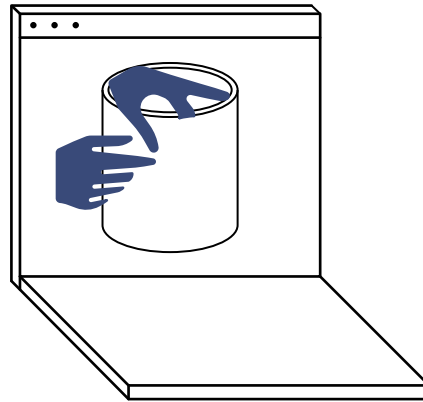

“The act of the hand tracking was inspiring, is the meaning more than just revealing and recording the process?” “The process isn’t always invisible, rather continuously evolving, how much to share about the process isn’t just about the mathematical calculation. The hidden process is where makes us wonder the mystical expression of the craft the most.”

When it comes to **the expression of craft**, A ceramic art student from KHiO mentioned an example during the workshop “one of an artist transforms the act of blowing and chilling the coffee into a ripple texture on the surface of the ceramic. “I would like to see how I could use it(the technique) to capture and freeze my different movement when I make my cup or plate.”

This inspired another possibility of using the technique to capture crafts hand movements, which was evidenced by the images (two drivelines that extracted from vary hand movement from two processes while crafter was throwing the pottery) and then transforming as construction lines together shape the form of the object.



/*Programme Slicing All in One*/

working together with Arely, we exam both the usually separate workflow between CAD programme and slicing software, we use the plugin to bridge the gap of it, here we can see the potential of using hands trace to define the gcode that allows the machine to follow where the hands move.

However, working with the printer itself is not an effective process, as we have examined at your first visit. we start to think about what is the value this exam might bring to? because sometimes what you need from the aesthetic and the smoothness of that hand made is never is able to achieve from the machine, you can clearly see its nozzle trace leave were on the surface.

however, when it comes to the production mean the digital fabrication (3d Printing) tool, people always being able to look for alternatives just like the previous practices from “digital craftsman”

due to the machine accessibility, my exploration with the fabrication tool could not be able to continue, so I decided to switch back to the cad programme and look for its potentials in engaging other ceramic making techniques. for instance like slip casting.

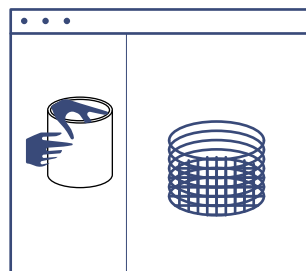

(Example Scripts see: Appendices)

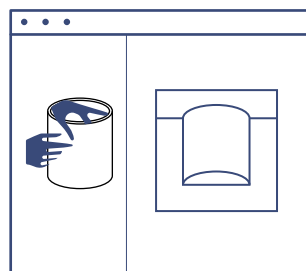

(Example Scripts see: Appendices)

What else might be tracked? - Workshop

I held an ideation workshop with a 5 design students. After a quick presentation of the project process and an introduction of the data tracking techniques, participants were first asked to play with the tool and imagine what it could be used .

A couple of inspirational prompts were shown(e.g. ‘consider data tracking by’) to guide them how might these data further being used for craftwork.

The workshop resulted in 24 quick idea sketches; there were categorized into tracked data as means that enhance the craft people expressive purpose.

Those are more than the hands and analogue tools which can achieve, which would make the digital tool become the extension of craftsmen’s “hands”.

After reflecting on the resulting concepts and the initial brainstorming session, I decided to explore more sensible and poetic data both inwards(personal) or outwards(environmental) could be collected and further being used as insparations craft people’s creative materials when they are customizing their objects, and then make those data sculpture.

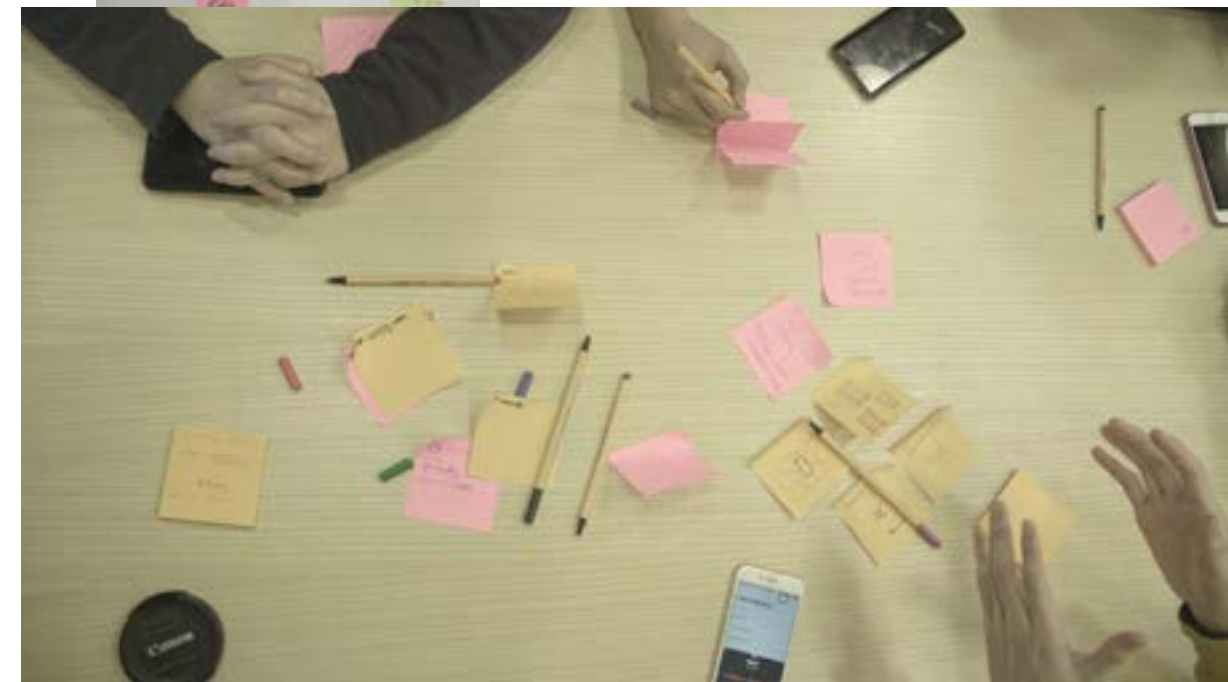

Data × Object - Possibilities with Creative Extension of Craft

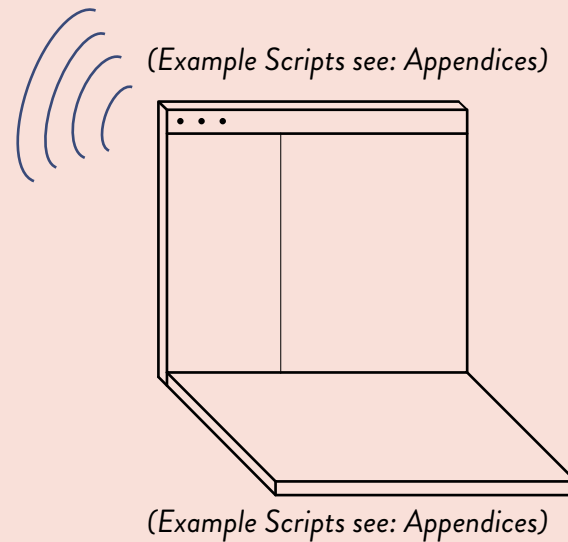

*/*Sensory Programme*/*

Often, digital fabrication and its portrayed as replacement of the craftsman and erase the human making traces. "In the face of mechanized production, hand skills became less central to production, and design, traditionally unied with the role of the artisan emerged as a separate discipline."

Apart from the previous probes which embedded hands as mediated input in the digital design tool, how might we make the digital tool even "closer" to the human? After synthesis, the insights from the first brainstorming workshop, backcasting the video sketching and interviews with experts. **My hypothesis was introducing a digital tool might sensory human, which could collect the data both from (inward) and environment and incorporate into the craftwork.**

//Informative Objects as Probes



Inspired by a Parisian designer Mathieu Lehanneur's set of jars and urns "Age of the world" that each map out the age of the population in given countries. These three-dimensional population pyramids show the past, present, and future evidence of the fate of population "Major events in different countries, like wars or baby booms, can be interpreted and touched."

More importantly, I didn't mean to propose how the **data** × **object** should have appeared the way it was referenced to be, but rather inspiring craft people through juxtaposing data and object to seeing what the combination of data and materiality might be? Thus engage their practice with the data.

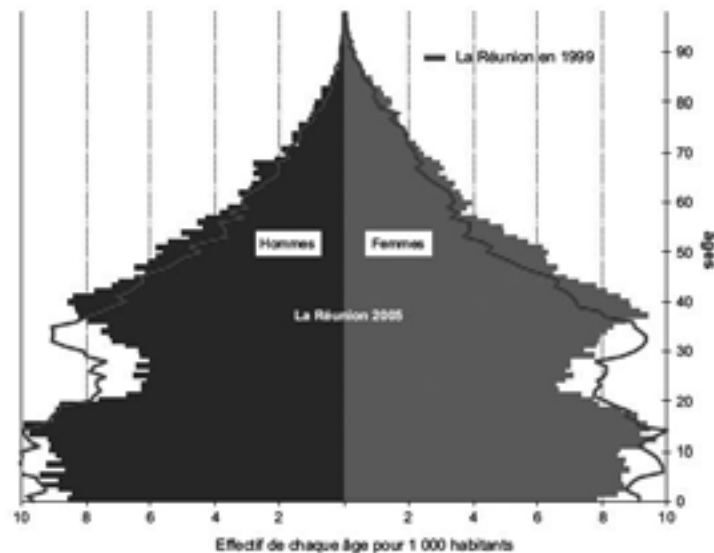



“A plate that imprint terrain data, have a taste of nature.”



“Freezing the act of chilling the coffee.”



<http://bengler.no/terrafab>



<http://www.realitat.com/microsonic/antony.html>



“A mug that you can feel the climate change when you drink coffee”

“”

“”

<https://gravitron.com.au/climatecoaster/>
58

//How to inspire craft people?**/*Data Clay Co-Creation Workshop*/**

To come up with a digital design tool which has the potential possibilities to use data to enhance craft people's creative works,

I first need to understand how the data could be interpreted and transfer to characters of the artefacts. To do so, I realize that it is essential to take inspiration from the ceramics craft itself.

6 ceramic art students in art and craft department at KHiO(Oslo National Academy of the Arts) were invited to the workshop. Half of them have basic experiences working with digital fabrication(both CAD programme and AM) in making ceramic. Several short tasks were given out, resulting in rich collections of design elements and inspirations.

The agenda of this workshop began with introducing a near-future scenario where data might be used as ceramic craft material for people's creative work.

**/*Visual Cards*/**

*Polaroid size cards were printed out as a visual repository, Including **all types of fabricating techniques(both analogue and digital), aesthetically expression(shape, form, texture, etc.)**. The aim was made allows people to associate data with **aesthetic expression**, as well as during the workshop process as a tool to allow participants to get into the right mindset, being able to broaden the imaginations and ideations for collecting rich design materials.*

*/*Workshop Agenda*/*

The workshop was divided into four parts with 3 task cards and in addition to the blank template that was used for writing/ drawing and ideas visualization during the workshop.

Starting with the warm-up question:

- **What kind of data people would like to embody in their artefacts?**
- **What are the context and the place where the data can be put in?**
- **How do you associate data with the visual perception of what it might look like?**

After the discussion, participants were asked to draw out what kind of physical manners the data could be interpreted as.

<p>Data</p> <p>Biological Data fingerprint heartrate fingerpressure sound movement</p> <p>Enviromental Data geolocation temperature weather time</p> <p>Data</p> <p>what kind of data you would like to embody in your artefacts.</p>	<p>Contexts and places</p> <p>explain the relevent contexts with the data</p> <p>where would you put it</p> <p>Data × Context</p> <p>Where could these data be put in? draw out the scenario</p>	<p>Draw! Draw! Draw!</p> <p>form cross-section section shape patterns twisted wave hybrid assembly</p> <p>Data --> Translation</p> <p>Associate data with the visual perception of the created process.</p>
--	--	--



*/*Learning Outcome*/*

Some results from the workshop were discouraging. Even though introducing the digital design tool was also part of the agenda, participants, in general, are more interested in how might the digital tools bring creative possibilities to them. Reactions to using the digital tool to aid production were generally mixed, and the discussion was not as rich as I had hoped for.

Alternatively, **participants are more tended to looking towards the creative use of the CAD drawing program.** For instance, one of the participants described:

“I am interested in using the technique to capture the movement, I want to capture the different movement of my hand, and I am eager to learn about like CNC or 3D printing, to make a plaster mould for my hand data sculpture.”



Workshop participants are interested in the fact that data could be used as design materials for creative means. which could be implemented into their process. Majority are interested in the aesthetic perspective, and drawing towards its tangible emotional connections.

“Materializing the data could be used as a means to reveal and show something you don’t normally see in the making process. Reveal and augmenting data might make the invisible process of the craft even more meaningful.”

-- one of the workshop participants described.

/*General Concerns on Aesthetics*/

“How much the aesthetic you made **the decision that is based on your designs of the data?**”

“**How to retain the narrative attributes of the data objects while controlling the aesthetic appearance ?**”

“And more specifically, what do the data need to be in aesthetically if hey would use the data? I would like to see how does it apply to the where is close to the hands, as long as you are making ceramic, it has to work as a container that you can use it for carrying something.”

Some of the feedback I categorized as the general concerns on the aesthetic of the produced object 's.



/*A System Transforms the Shape of Form Through Tailoring the Meaningful Data*/

Other than that, as one of the craft people described: How different data could be used to establish a connection between formal expressions and how does that presents with form language might looks?

As she mentioned: “I am eager to look for the possible aesthetical outcome. This is an interesting field, but at the same time, it is not just like I can feel. You need to have some tools but you are incapable of using them. As a result, you don’t know how to integrate that in your process. but this was like very direct way could take something from outside, and then using it to complement your practice, or even take your process further.”

/* Data objects as Visual Catalog for Referencing*/

Another aspect was to consider data materialization as a visual reference. A reference which is similar to models or sketches, Since most of the creative inspirations come from visual perception.

“Printing out the data, use it in the analogue sense, and then take this dataset as a creative framework to work with, functioning just like sketches and models. And then we can take out of from what we want to build our work on the top of it.”

-- from one of the workshop participants.

To quantify the data into visual perception I sketch out some of the variables geometrically.

//Mindwave

//Heartbeat

//Breath Rate

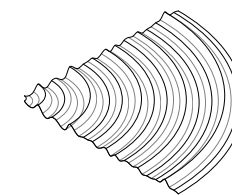
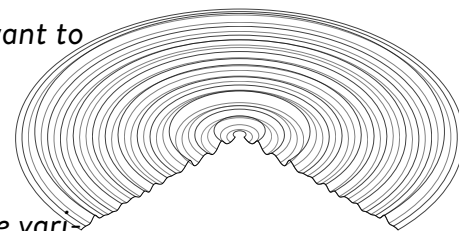

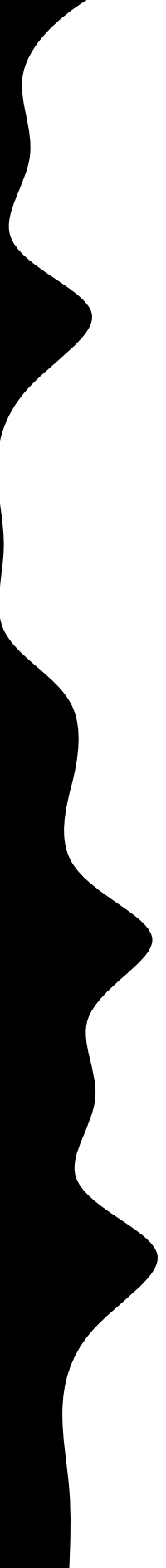

//Mindwave

//Heartbeat

//Breath Rate

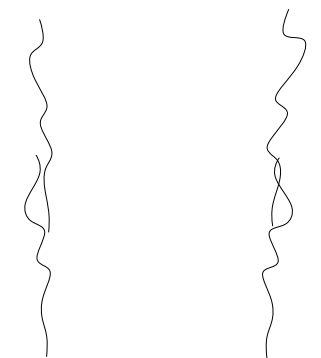
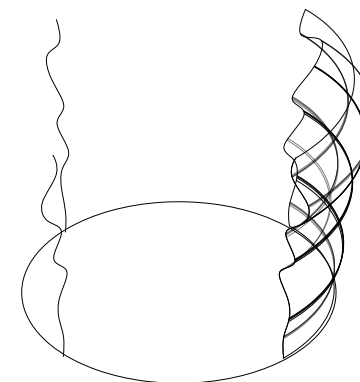
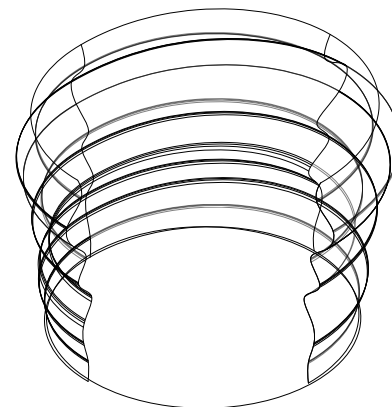
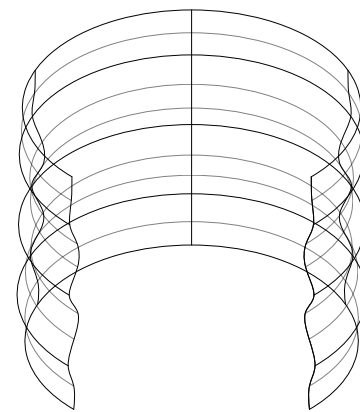



/*Mixed Opinions on Aesthetics */

*People's opinion towards the aesthetic of produced objects are mixed
"I am not really interested in aesthetically
I don't 'think aesthetically would be in the first place
I would be more interested in using in the process and clay's materiality aspect.
I would like to see the time and different making factors will have under the piece, the time so much triggering in these objects which makes data object is even more interesting in that way if you are going to collaborate with someone, especially in more intellectually."*

"The aesthetic part is weight more important from the craft perspective than the collective data perspective that people decided. The pleasing collection of the data is not what we are interested in."

"and athetically, sometime you do it with the intuition, which is something that makes you wonder for a moment"





Collect data from ceramic artist

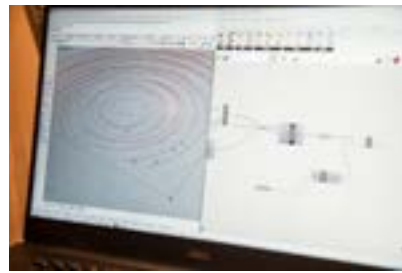

Use digital tool to implement ideal patterns



Print out positive for mold making

/*craft and collaboration process*/

After the meeting, to help myself understand the process of crafting a ceramic object, with the help of Lina I decided to make a platter mold for clay slip casting, I decided to first become a crafter, before designing better for the crafters.

Having been collaborating with craft people and **teach me his skill and the acquisition of knowledge is just as important to me personally as crucial the actual designed and making itself. This was what inspired me to see crafted objects as narrative to describe the crafting process itself.**

The mapped out process knowledge presented how



Make a plaster mould out of 3d printed PLA



Plaster A: Drying too fast



Leaving air bubbles on the surface after demolding



Plaster B: With normal drying speed



Damaged the plaster surface during demolding



Damaged the plaster surface during demolding



Silicon First Cast surface



Treat with plaster



Damaged the plaster surface during demolding



Silicon second Cast, with a release agent, pretreat



Hard to remove silicone out of silicon

“Collective Thinking Programme”- Possibilities as Medium for Storytelling

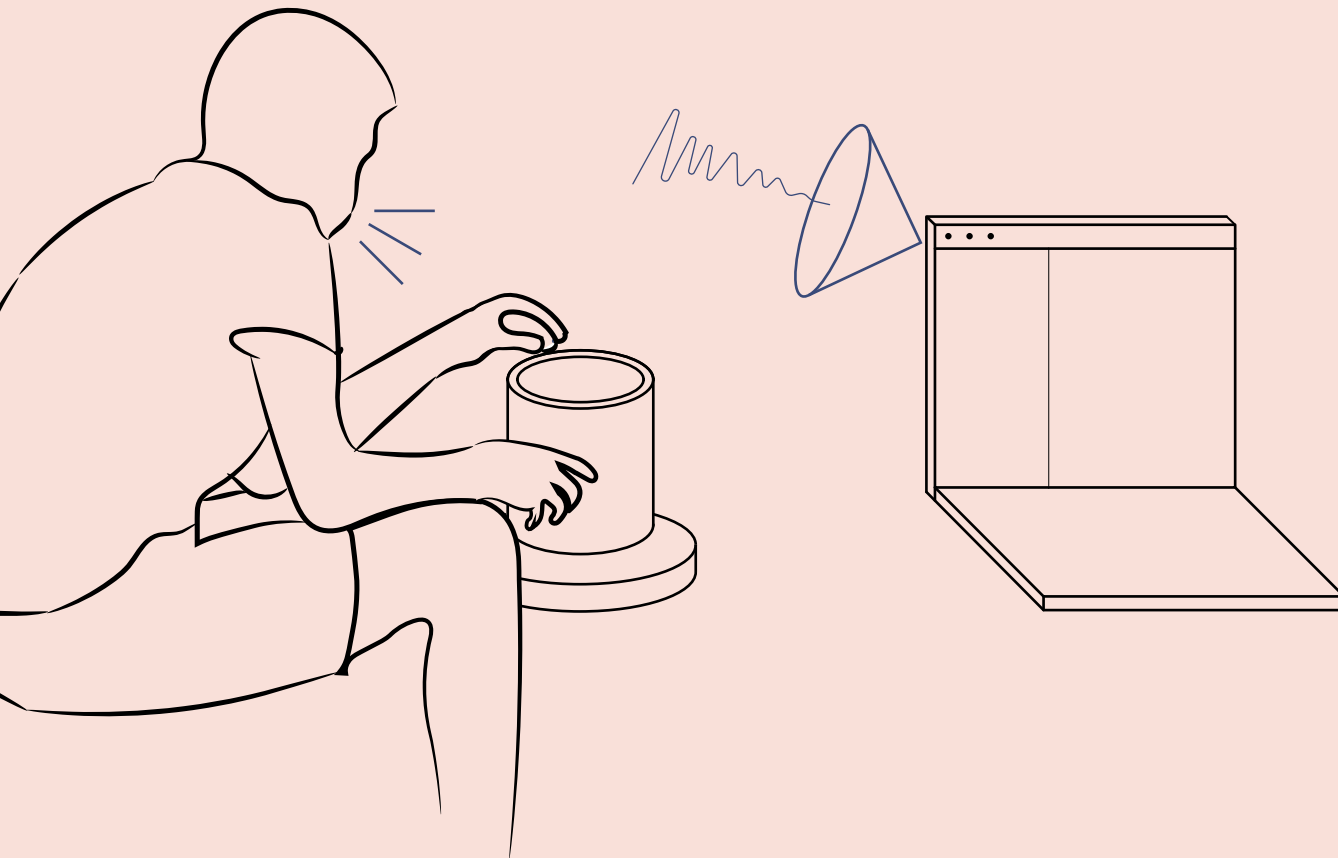

*/*Collective Thinking Programme*/*

Name inspired by Sigrid Espelien’s *Collective Thinking Machine* (see *Field Study: Expert Interview with Sigrid Espelien.*) The collective thinking programme intends to reflect on the rapid spread of digital technology in the field of craft, **the process of collecting stories and collaboration with crafters** both define the core forms of the craft value. I believe **digital tool should be capable of conveying the emotional value of the craft, which can reflect craft value based around memory and his/her view on the community.**

The two “narrative objects” are made of two collaborative making manifest, created from the record of the tales, captured by “collective thinking programme” in digital audio files, which then used as reference for the digital modelling. Subsequently, the designer and crafter were together materializing the story in ceramic making.

<quote>

The designer today should view craft as a storytelling device, their unique position enabling them to embed their own experience and passing this on to the user. 'The storyteller takes what he tells from experience, his own or others, and makes it the experience of those hearing the tale.'

— Walter Benjamin

(German philosopher, cultural critic)

</quote>





//Concept Development

Crafted Objects as Narratives

*/*Working Collectively with Crafters*/*

*Robert was the one who was raising most questions about the aesthetics of the digital produced object. **He was curious about and fascinated by the unpredictable result that being generated alongside our conversation.** This reminds him about the process of working with clay which he found the charm of unpredictable and unexpected results. .*

***He chooses one of the generated results that he aesthetically prefer.** The reason why he chose that particular form was he thought that “Raised part of the surface looks like a handle, as you can hold it easily. He likes the unexpected way of producing functional objects, which usually took too much consideration on designing it in the normal case.”*

An interesting finding from this process was when the artist see the generated results, he starting to interpret it in a different way and giving the object another level of narrative value.



Result that being generated during the conversation.

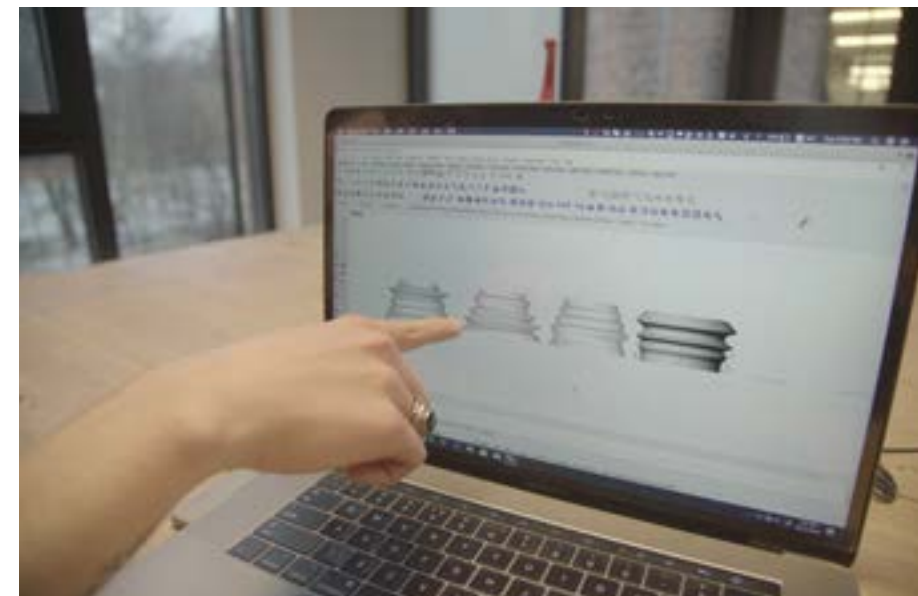

//Narratives

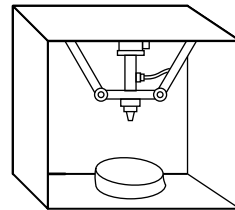
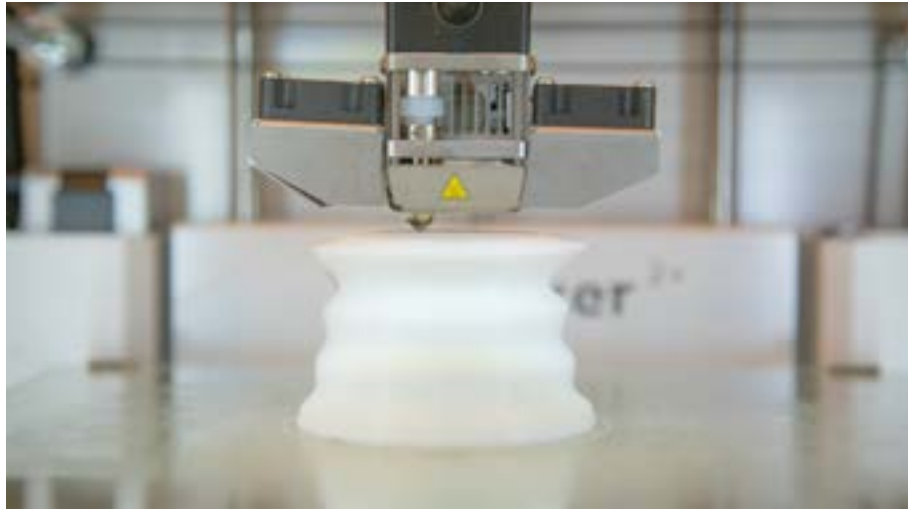

Introducing the making technique to crafters

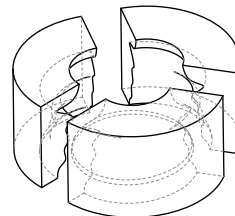
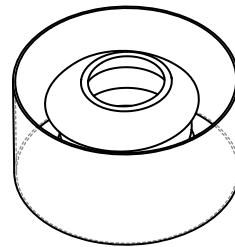

The physical objects being created, whilst being produced with a reliance on digital technology

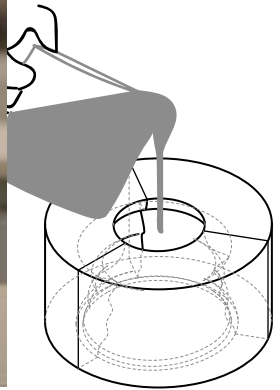

*give the craft value to the **collective work***

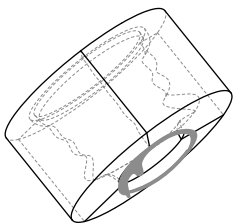



The notable holder



Look at the value of craft as **less monetary**



And more in regards to its **unique record which reflect makers making identity.**



or the unique character of his work.

Concept Development

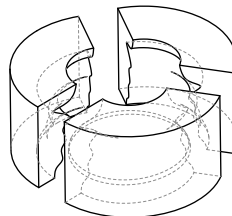
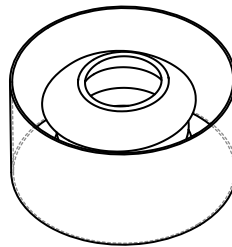
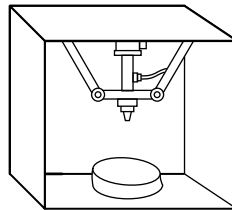
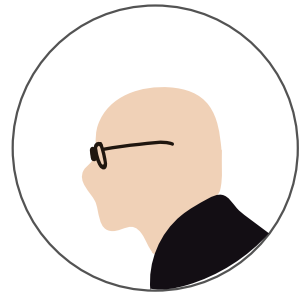

Concept Development

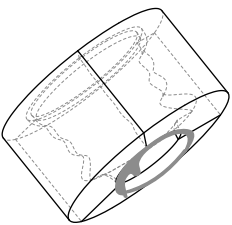
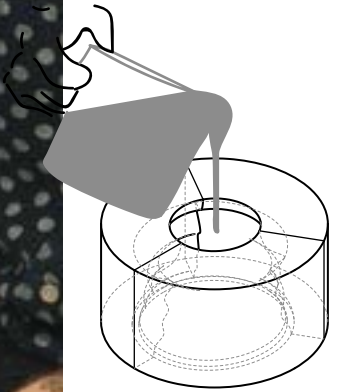

Concept Development



The tangible connection with the making



Concept Development



Crafter decided to showcase with his other works that is athletically similar



Surface imprint crafters emotional value which appears as its unique aesthetics





What's the next?

What's the next?

//What's the Next?

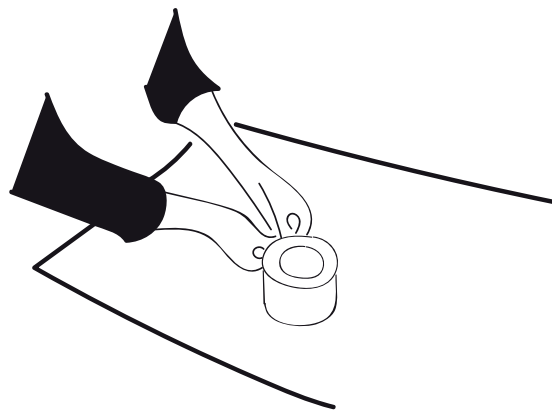
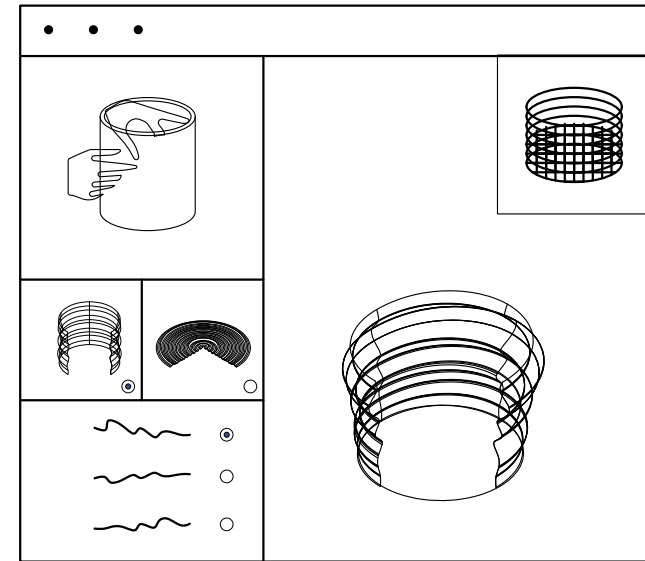
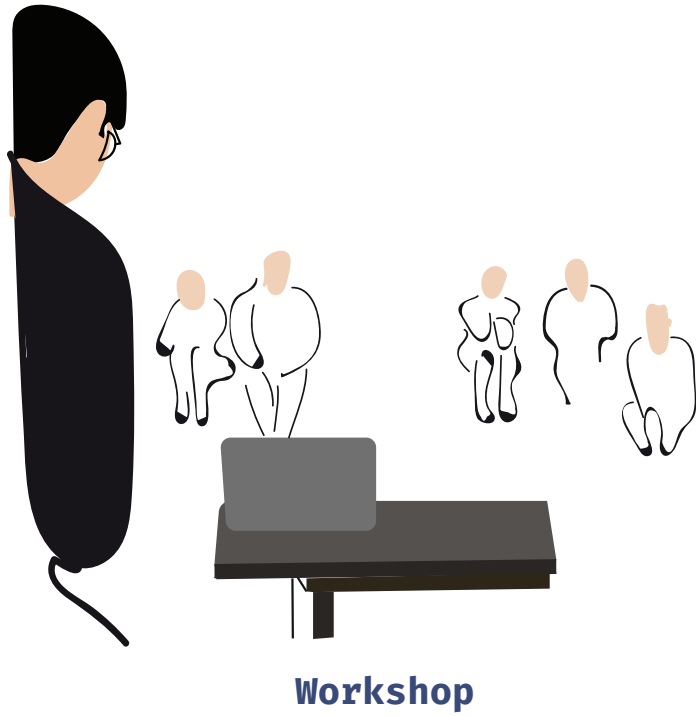

//Reflection

*This project has been challenging for me, the endless making techniques in ceramic, I have **learnt that I want to know about in ceramic making**. I am satisfied with the knowledge I have now after working with different making technique and materials.*

To end up with a project aiming to unfold people expectations towards multiple digital making possibilities, I do think that my design proposals approach to the right direction, those who have shifted their attitude towards digital tool involvement from unsure to open and work together with me would become the strongest evidence.

*I am really **open for future collaboration with the future of clay programme at arts and ceramic in KHiO's**, I hope my exploration process will inspire more designers and ceramic artists to explore this field future.*

//Appendices

Processing a Grasshopper file in Rhino

Since most craft students at khio would have CAD course and digital fabrication facilities accessibilities. Here I would document how to guide students to launch and use the scripts I made in rhino's plugin grasshopper

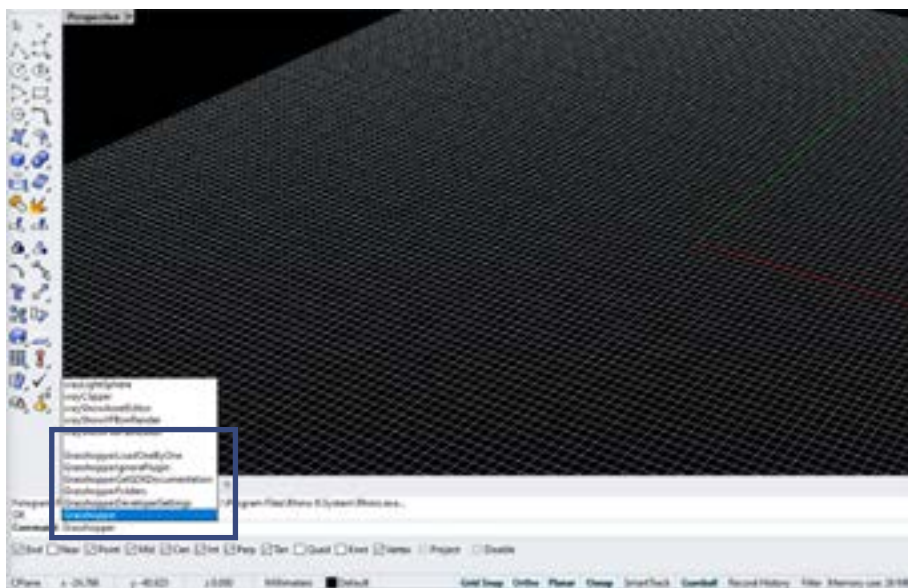

User types in "grasshopper" in rhino command bar.

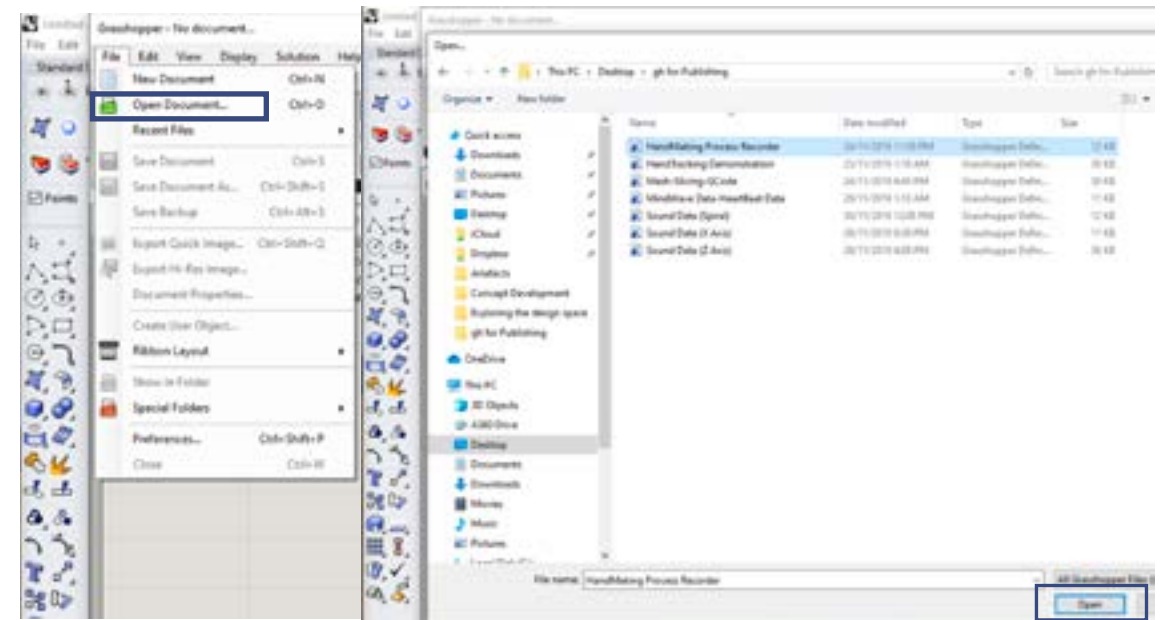

"Open document" in grasshopper command bar.

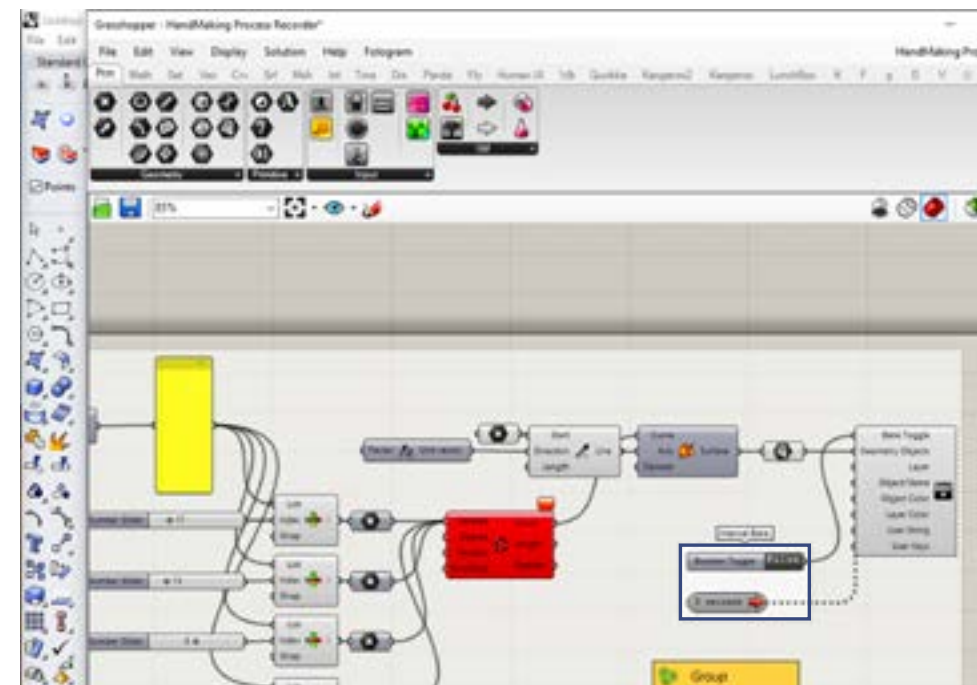

Here is the example of "Process Recorder" open

The Main Collections of the Grasshopper Definition Interface

*/*Hand-E-Craft*/ Scripts*

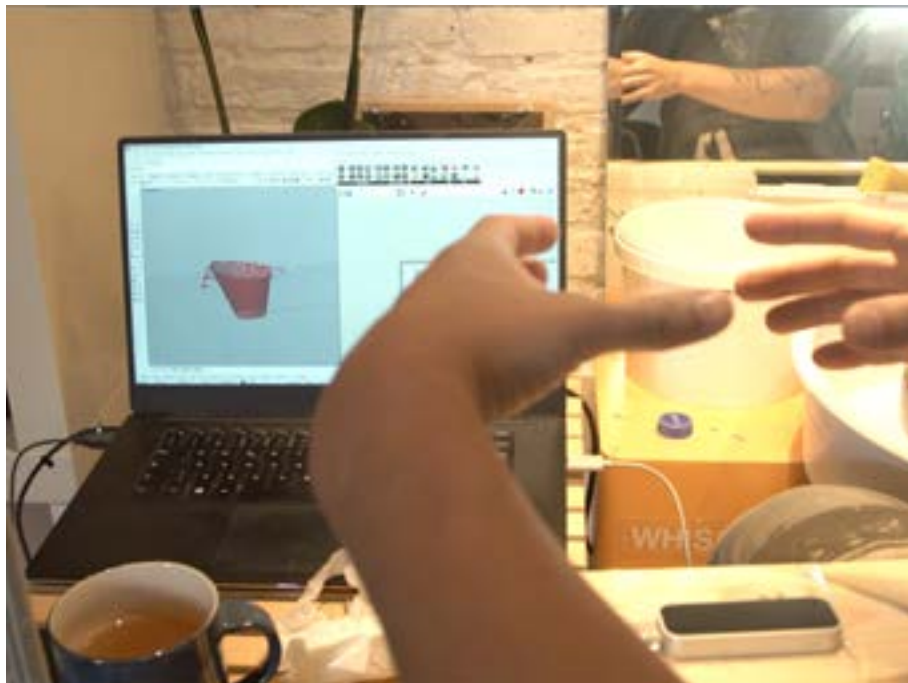

Leap motion sensor tracks hands movement and brings the real-time hands input into CAD modelling environment.

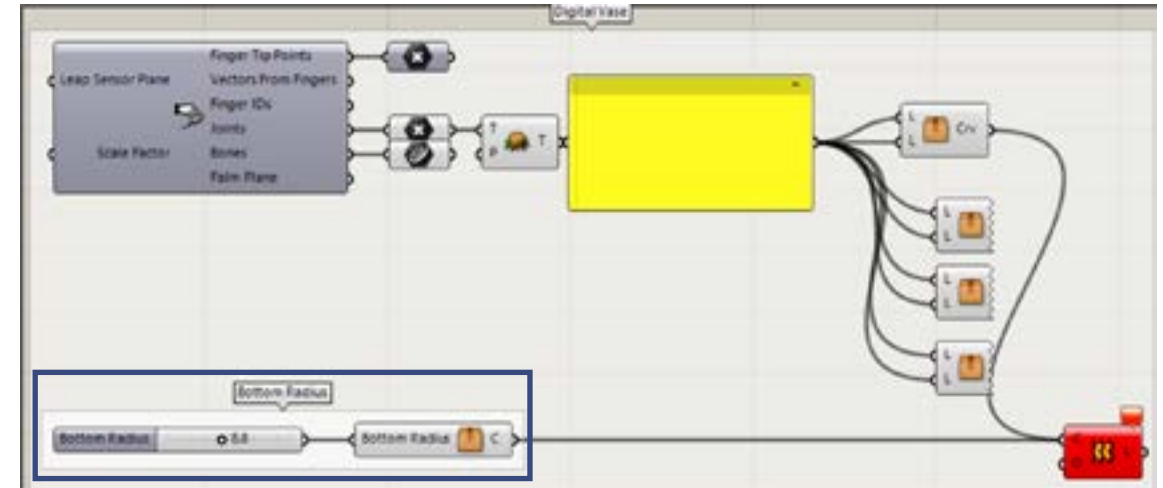

User adjusts the **highlight UI slider** to modify the parameter of the “bottom radius” make sure that within the safe zone of throwing wheel.

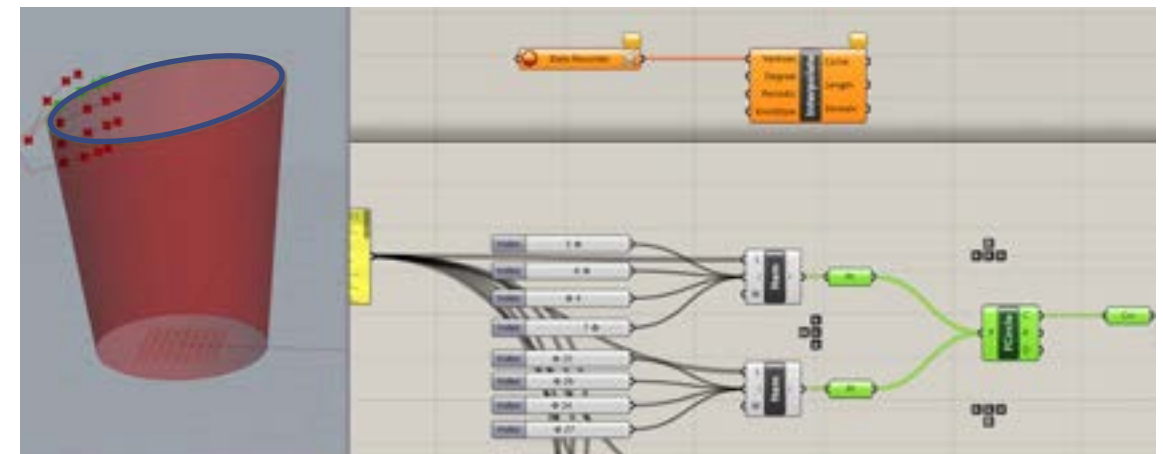

User is able to use hands make a circle, a surface(display in red) will loft between top and bottom.

*/*Process Recorder*/ Scripts*

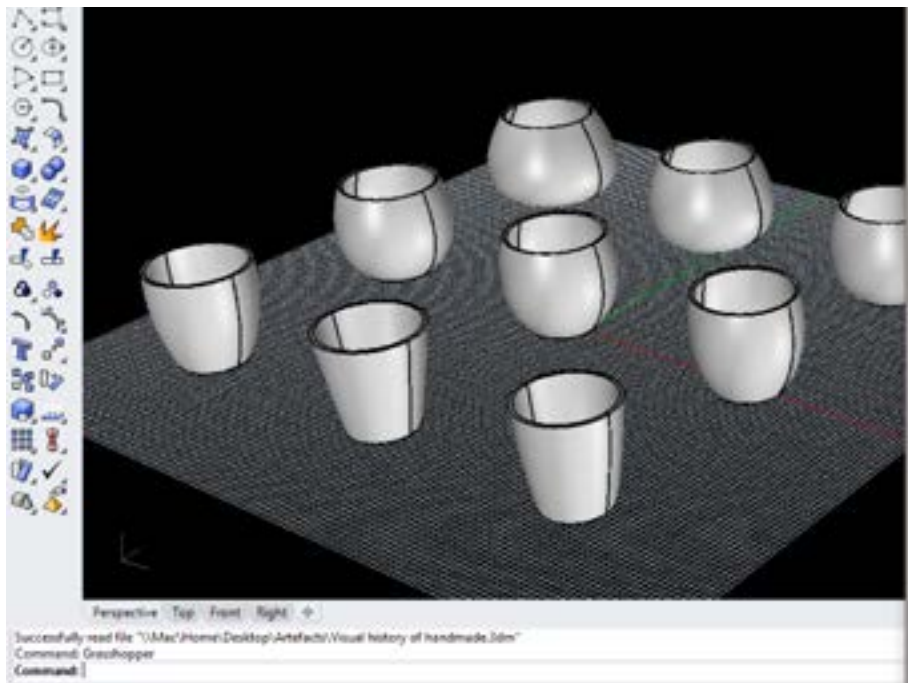

User is able to record the process object

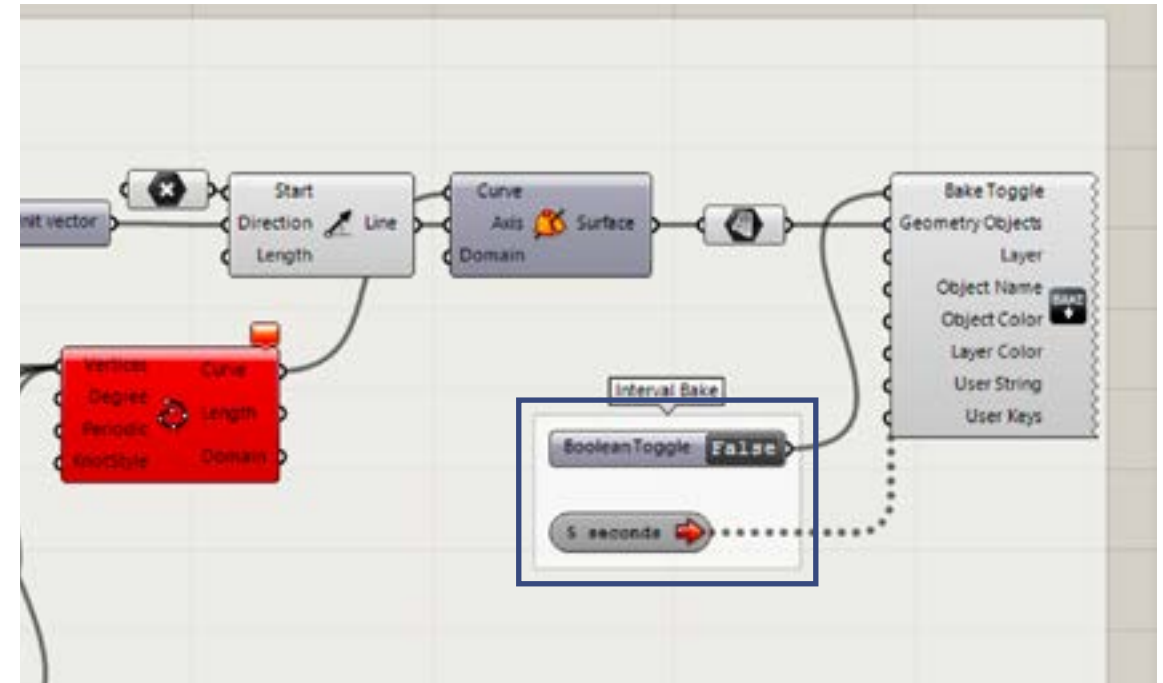

*User adjusts the **highlight UI slider** to adjust the interval time to record their process.*

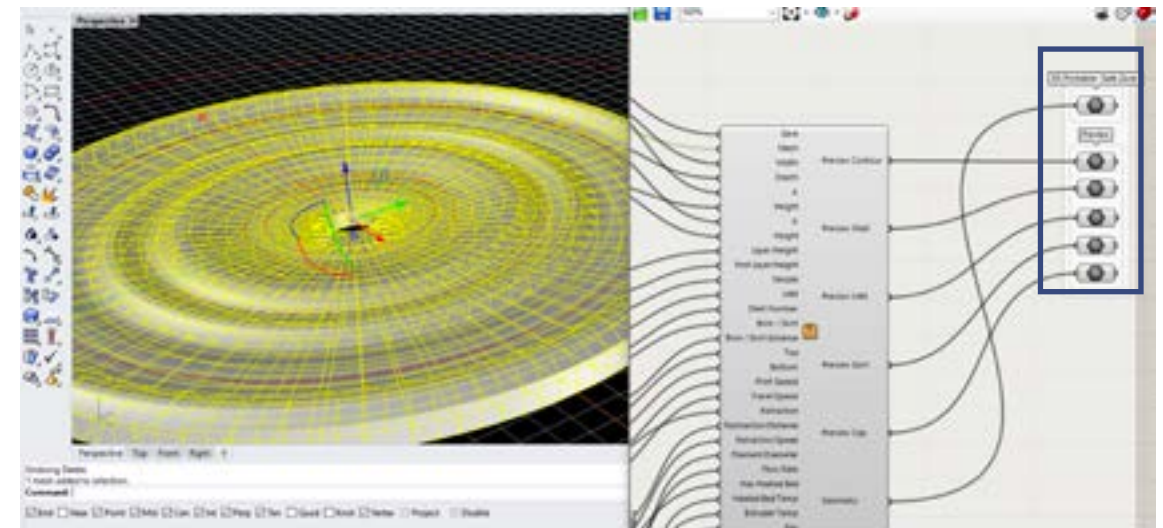

bridging the gap between CAD programme and slicing software, user allows to use their hands trace to generate the gcode.

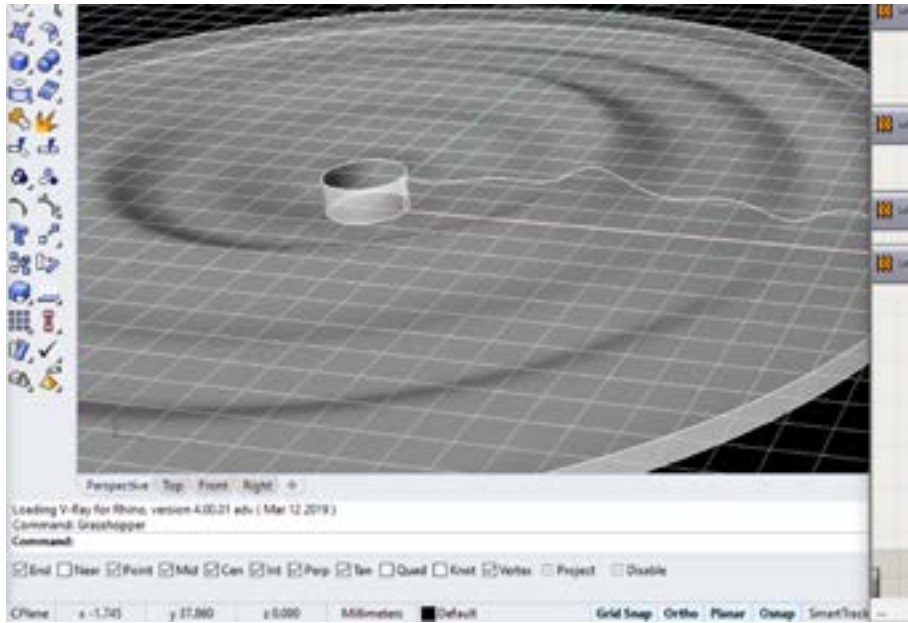

The audio form is real-time generating in the modelling environment.

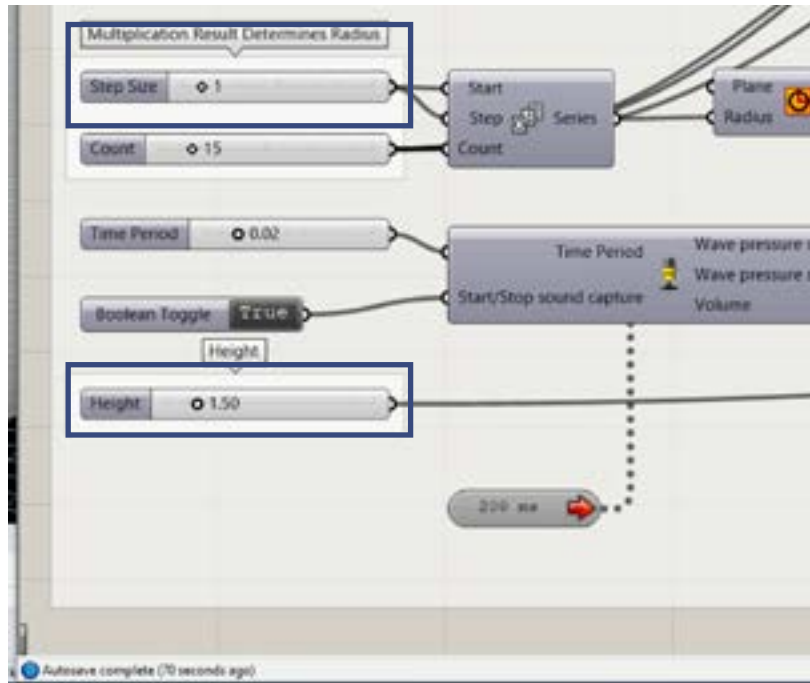

User adjusts the radius and height of the plater

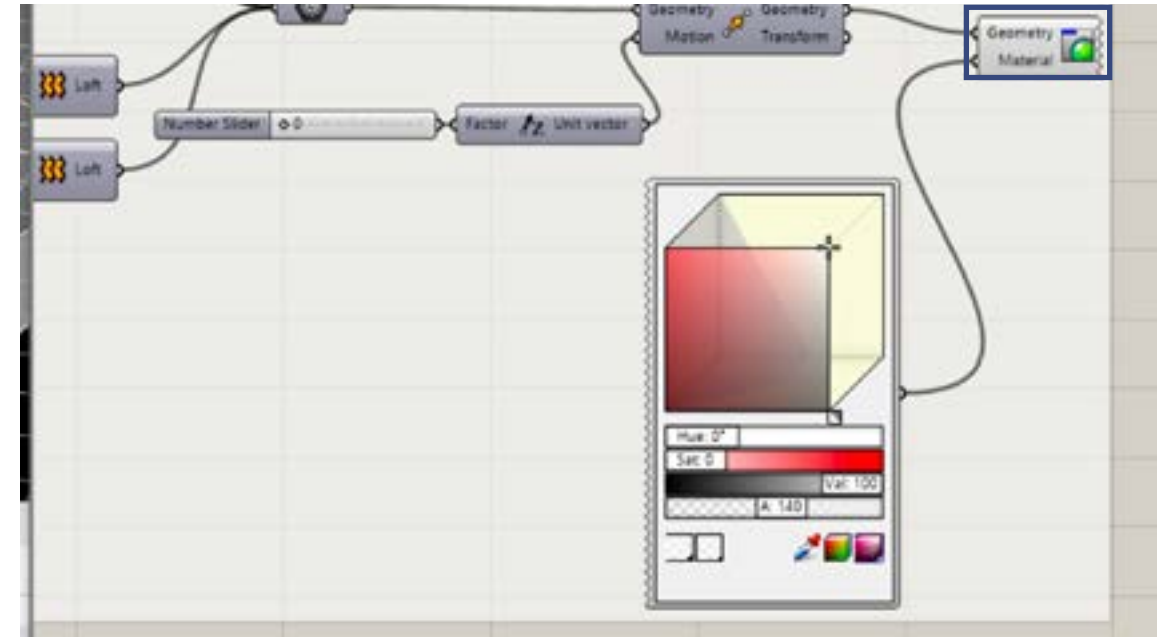

User is able to use bake out the form that he prefer by right click the mouse axis



and then click the highlight "bake" bottom

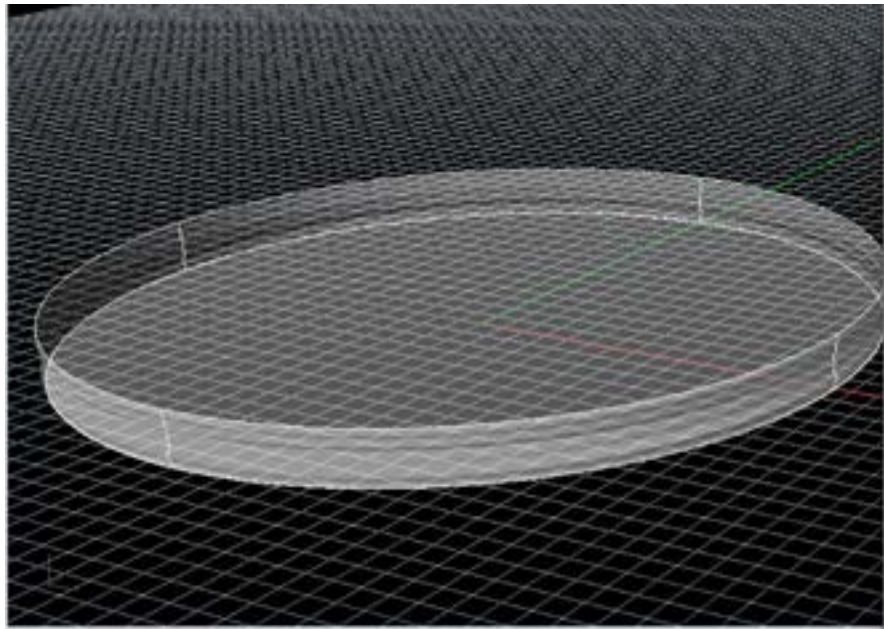

The audio form is real-time generating in the modelling environment.

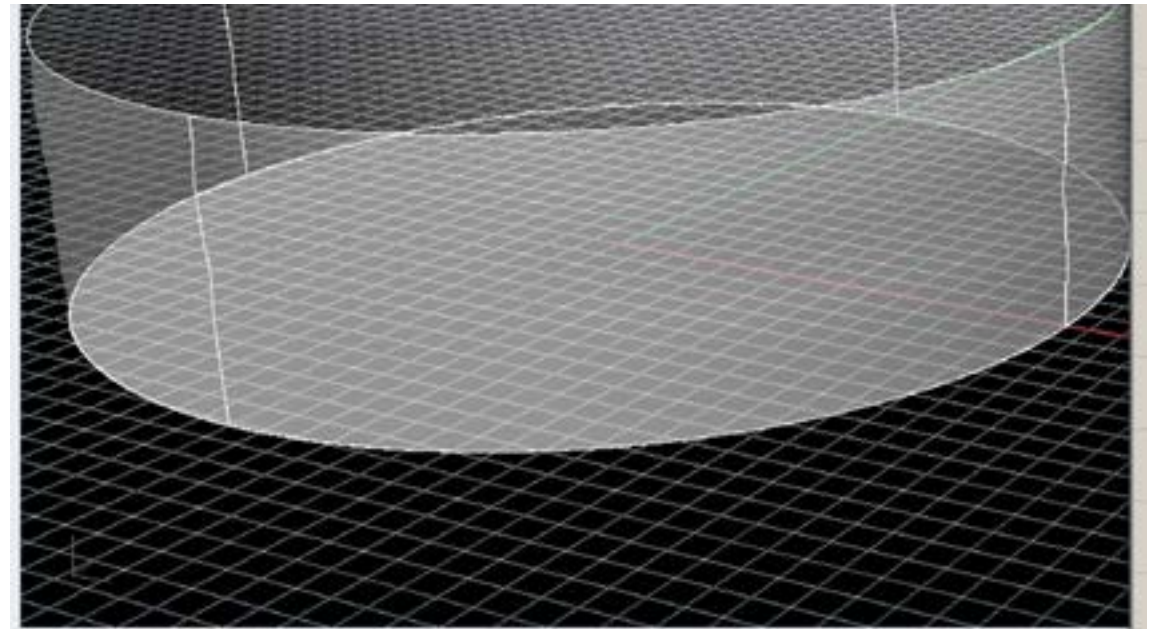

User is able to use bake out the form that he prefer by right click the mouse axis

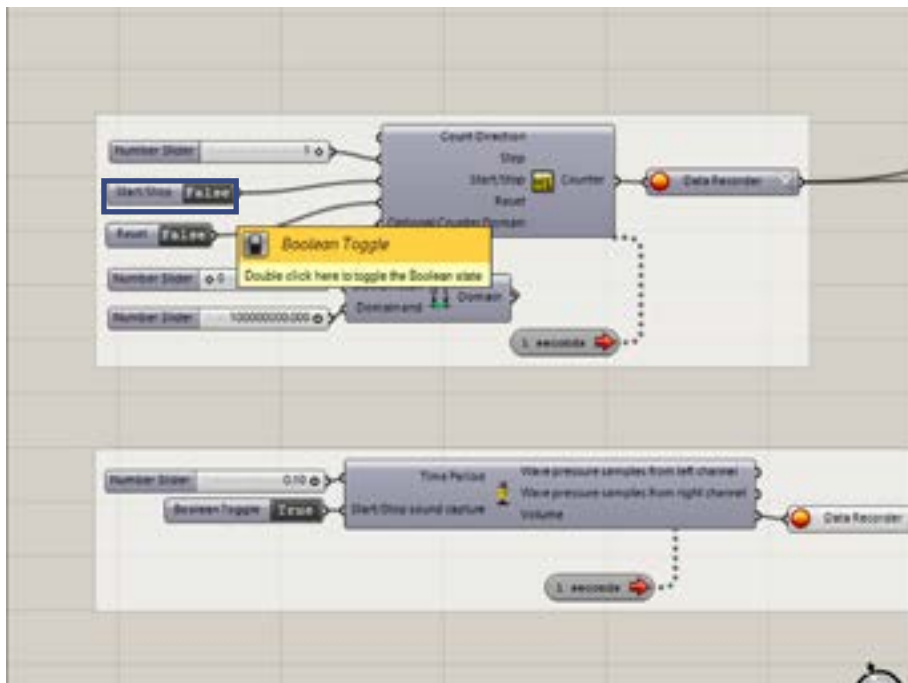

Toggle the bottom to start

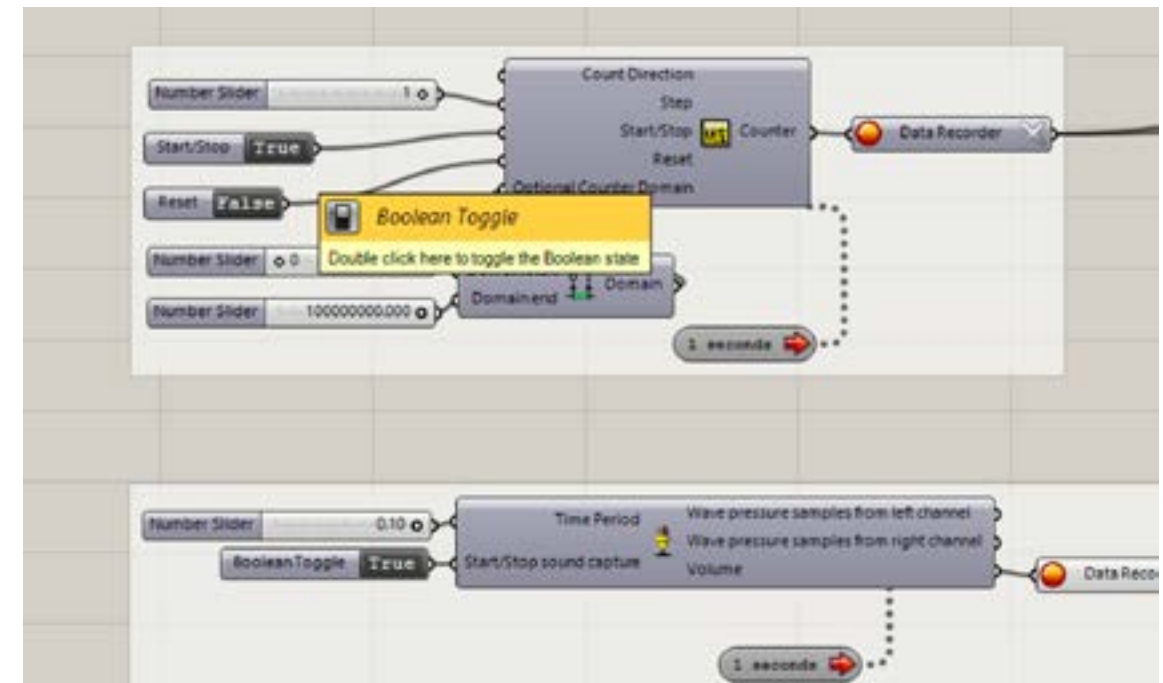

Toggle again Stop the record

//Digital Tools that I used in explorations

Hardware

//Leap Motion Sensor:

Sensor devises that supports hand and finger motions as input without hand contact or touching required. I chose as a tool to capture crafters' hand's movements while observing pottery throwing process.

Software

//Rhino+Grasshopper

Throughout the entire exploration process, I have been using Rhinoceros and its versatile plugin Grasshopper for prototyping.

/*Plugin for Grasshopper*/

Firefly: *In order to connect leap motion sensor with Rhinoceros, a grasshopper plugin firefly (figure. needed) was used to stream the real-time data between the physical and digital worlds enabling the possibilities to prototype through virtual and physical.*

Droid: *A 3D printing-related grasshopper plug-in with controllable model slicing, customized path plotter and Gcode generation.*

Human UI: *is an interface paradigm for Grasshopper, allows Grasshopper definition with custom user interfaces. I used that to create some understandable interface for craft people with no understanding of grasshopper to be able to test with my prototype.*

//Bibliography

rubenbristian.com. "In-Flexions | Design Numérique." In-Flexions.Com, 2014, in-flexions.com/. Accessed 13 Dec. 2019.

"Projects - Unfold Design Studio." Unfold Design Studio, 2017, unfold.be/. Accessed 13 Dec. 2019.

Olivier Van Herpt. "Olivier Van Herpt." Oliviertanherpt.Com, 2019, oliviervanherpt.com/.

"Mathieu Lehanneur | Works." Mathieulehanneur.Fr, 2015, www.mathieulehanneur.fr/works. Accessed 13 Dec. 2019.

"POTTERWARE | Emerging Objects." Emergingobjects.Com, 2019, www.emergingobjects.com/project/potterware_litev2/. Accessed 13 Dec. 2019.

Keep, Jonathan. "Jonathan Keep. Home Page." Keep-Art. Co.Uk, 2019, www.keep-art.co.uk/. Accessed 13 Dec. 2019.

:: "Realität ::" Realitat.Com, 2012, www.realitat.com/2013/.

"Bengler: Terrafab." Bengler.No, 2013, bengler.no/terrafab. Accessed 13 Dec. 2019.

"Hybrid Reassemblage: An Exploration of Craft, Digital Fabrication and Artifact Uniqueness." MIT Press Journals, 2019, www.mitpressjournals.org/doi/10.1162/LEON_a_00477.

"Mitchell Whitelaw." Mtchl.Net, 2018, mtchl.net/. Accessed 13 Dec. 2019.

LESLIE, E. "Walter Benjamin: Traces of Craft." Journal of Design History, vol. 11, no. 1, 1 Jan. 1998, pp. 5–13, academic.oup.com/jdh/article/11/1/5/425053, 10.1093/jdh/11.1.5. Accessed 13 Dec. 2019.

Guto Requena. "Guto Requena." Guto Requena, 2011, gutorequena.com/. Accessed 13 Dec. 2019.

"Data Clay." Data-Clay.Org, 2015, www.data-clay.org/. Accessed 13 Dec. 2019.

The MIT Press. "Abstracting Craft." The MIT Press, 2016, mitpress.mit.edu/books/abstracting-craft. Accessed 13 Dec. 2019.

Focus, In. "KWOK PAN FUNG - In Focus." Thedice.Co, 2019, www.thedice.co/Art/Kwok-Pan-Fung/. Accessed 13 Dec. 2019.

Zoran, Amit, and Leah Buechley. "Hybrid Reassemblage: An Exploration of Craft, Digital Fabrication and Artifact Uniqueness." Mit.Edu, Apr. 2011, dspace.mit.edu/openaccess-disseminate/1721.1/78845_0024-094X. Accessed 15 Aug. 2019.

Garlick, Aaron. "Aaron Garlick." Aaron Garlick, 2018, www.aarongarlick.com/. Accessed 13 Dec. 2019.

"Crossing Parallels – Amandinedavid.Com." Amandinedavid.Com, 2014, amandinedavid.com/Crossing-parallels. Accessed 13 Dec. 2019.

"Projects." Amitz.Co, 2009, amitz.co/projects.html. Accessed 13 Dec. 2019.

"Designers Party : Studio Homunculus : Joong Han Lee." Designersparty.Com, 2017, www.designersparty.com/entry/Studio-Homunculus-Joong-Han-Lee. Accessed 13 Dec. 2019.

Jacobs, Jennifer. "Algorithmic Craft: The Synthesis of Computational Design, Digital Fabrication, and Hand Craft – MIT Media Lab." MIT Media Lab, 2017, www.media.mit.edu/publications/algorithmic-craft/. Accessed 13 Dec. 2019.

