



UNHCR
The UN Refugee Agency



DIVISION OF PROGRAMME SUPPORT AND MANAGEMENT
SHELTER AND SETTLEMENT SECTION

SHELTER DESIGN CATALOGUE

January 2016



This publication was produced by UNHCR Shelter and Settlement Section.

For more information contact:

Shelter and Settlement Section
Division of Programme Support and Management
United Nations High Commissioner for Refugees
Rue de Montbrillant 94
1202 Geneva
Switzerland

shelter@unhcr.org
www.unhcr.org

Shelter Design Catalogue online:



PREFACE

Shelter is contextual and there exists no 'one-size-fits-all' solution which can be applied worldwide. Whilst emergency phase responses often involve the provision of tents or emergency shelter, it is essential to ensure that shelter assistance programmes can evolve toward more durable and sustainable solutions maximizing, wherever possible, the use of local material, skills and building techniques. To support this evolution, within the framework of UNHCR's Global Strategy for Settlement and Shelter (2014-18), the Shelter and Settlement Section (SSS) has developed the Shelter Design Catalogue, collecting a number of shelter designs developed across a variety of locations, contexts and climates. While the collection of designs presented is by no means exhaustive, the publication aims to assist sector specialists in implementing a phased shelter response through more predictable planning and implementation.

TABLE OF CONTENTS

1. INTRODUCTION	5
2. GLOBAL SHELTER DESIGNS	7
2.1 UNHCR family tent	9
2.2 Frame tent	14
2.3 UNHCR Self-standing family tent	15
2.4 Refugee Housing Unit	19
3. EMERGENCY SHELTER DESIGNS	22
3.1 Gable frame, South Sudan	23
3.2 Tuareg shelter, Burkina Faso	30
3.3 Tuareg tent, Mali	34
3.4 Tukul, South Sudan	38
3.5 Tent Shelter, Afghanistan	42
4. TRANSITIONAL SHELTER SOLUTIONS	45
4.1 T Shelter, Azraq, Jordan	46
4.2 Compact Bamboo shelter, Ethiopia	51
4.3 Twin elevated shelters, Myanmar	54
5. DURABLE SHELTER SOLUTIONS	57
5.1 One room shelter, Pakistan	58
5.2 L Shape Shelter, Iraq	62

1. INTRODUCTION

UNHCR, the United Nations refugee organization, is mandated by the United Nations to lead and coordinate international action for the world-wide protection of refugees and the resolution of refugee problems.

UNHCR operates in an increasingly complex and challenging environment. Conflict, violence and persecution continue to cause large-scale displacement in many parts of the world. Providing international protection includes a range of concrete activities such as providing adequate shelter and settlement with the goal of increasing respect for, and ensuring the rights of UNHCR's persons of concern.

Providing shelter is one of UNHCR's institutional priorities. It is a fundamental human right recognized under Article 11 of the Covenant on Economic Social and Cultural Rights.

The right to shelter was further acknowledged in 1981 when UNHCR's Executive Committee produced a set of internationally recognized basic standards of treatment applicable in refugee emergencies. Amongst many other standards, it clearly states that "refugees and asylum seekers should receive all necessary assistance and be provided with the basic necessities of life including food, shelter and basic sanitary and health facilities."

Shelter is a critical factor affecting survival in the initial stages of a disaster. Beyond survival, shelter is necessary to provide security, personal safety and protection from the climate and to promote resistance to ill health and disease. It is also important for human dignity, to sustain family and community life and to enable affected populations to recover from the impact of disaster.

A shelter is defined as a habitable covered living space providing a secure and healthy living environment with privacy and dignity. Refugees and others of concern to UNHCR have the right to adequate shelter in order to benefit from protection from the elements, space to live and store belongings as well as privacy, comfort and emotional support.

Shelter should be adapted according to the geographical context, the climate, the cultural practice and habits, the local availability of skills as well as accessibility to adequate construction materials in any given country.

PURPOSE

The purpose of this catalogue is to present applied examples of shelter designs in a harmonised way to allow quick reference, comparative analysis and contextual assessment. By recording and presenting a diverse range of shelter design and development practice in a single document, shelter practitioners and other stakeholders may more easily access information on shelter types to inform their work.

The shelter examples presented are by no means exhaustive with respect to the range of shelter activities and practices in the field. Future revision will allow for the further inclusion of new designs and this catalogue should be considered as a 'live' resource.

The structure of the catalogue is built up of the following four sections:

- Global Shelter Designs
- Emergency Shelter Designs
- Transitional Shelter Designs
- Durable Shelter Designs

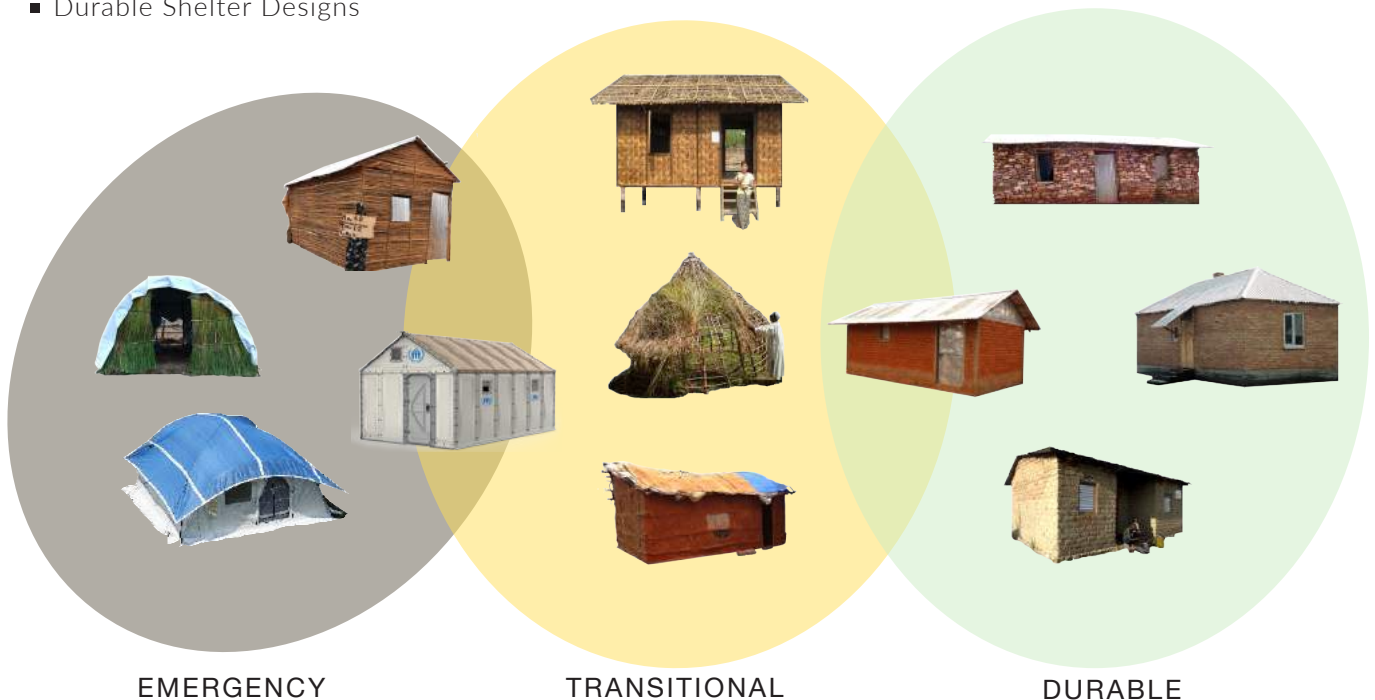

WHO THIS CATALOGUE IS FOR

This shelter designs document is designed for use by all UNHCR staff and partners working in the shelter sector. The information may be particularly relevant to practitioners who are supporting the development of shelter assistance programmes with consideration to shelter type and operational context.

ICONS



SUGGESTED TEMPERATURE RANGE



TIME FOR CONSTRUCTION



NUMBER OF PEOPLE REQUIRED FOR CONSTRUCTION





LIFE SPAN

* Subject of inclusion of appropriate NFI's and heaters where applicable to maintain a minimum internal temperature of 13°C



2. GLOBAL SHELTER DESIGNS

PROJECT PHASES	DESCRIPTION	UNHCR FAMILY TENT	UNHCR SELF-STANDING FAMILY TENT	REFUGEE HOUSING UNIT
1. CONCEPT	<ul style="list-style-type: none"> Establish project parameters with technical requirements and spatial criteria Produce initial sketch designs Research and Development 	✓	✓	✓
2. PROTOTYPE	<ul style="list-style-type: none"> Select most appropriate design to prototype Refine final prototype to satisfy all technical requirements 	✓		✓
3. FIELD TESTING	<ul style="list-style-type: none"> Structural performance Technical resistance Cultural acceptance Environmental performance 	✓	↻	✓
4. PRODUCTION ANALYSIS	<ul style="list-style-type: none"> Costing Market and production capacity Transport Supply 	✓	✗	✓
5. FINAL PRODUCT	<ul style="list-style-type: none"> If necessary, carry out any revisions to prototype post-testing & analysis Finalize technical specification Manufacture and package final product 		✗	

2.1 UNHCR FAMILY TENT

UNHCR Supply Catalogue - Item No 05353

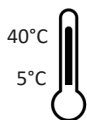

3 PERSONS



30 MINUTES



1 YEAR

SHELTER DESCRIPTION

The Family Tent is a ridge double fly tent with elevated walls. It has 16m² of main floor area plus two 3.5m² vestibules for a total area of 23m², double fold with a ground sheet. To assure stability, the outer tent is supported by 3 upright poles, 1 ridge pole, 6 side poles, 4 door poles, 3 guy ropes on each side and 2 guy ropes at each end.

DIMENSIONS

The outside dimension of the tent is 4m wide, 6.6m long including vestibules and has a centre height of 2.2m. The tent, including assembled guy ropes, has a foot print of around 61m².

PACKAGE

The double-fly tent and all accessories (including poles, pegs and hammer) are packed to ensure that the ground sheet protects the tent and accessories, and the metal poles and pegs do not pierce the bag. Assembly instructions are included inside each package with assembly instruction drawings.

MATERIALS

The outer-tent roof and innertent canvas is polyester-cotton blend and the groundsheet follows the plastic sheeting standard.

WEIGHT

Weight per unit is approximately 55kg.

VOLUME

Volume per unit is approximately 0.20m³.

LIFE SPAN

The tent can be expected to have a minimum 1 year lifespan, maintaining its sheltering and waterproofing capacities in all types of moderate climate.

COST

The tent has an approximate cost of 420 US\$, excluding transport.

OPTION KITS

SHADE NET*

The shade net is an accessory for the standard Family Tent that is highly recommended in hot climate, to reduce the temperature inside the tent.



2 PERSONS



10 MINUTES



1 YEAR

WINTERIZATION KIT**

The Winterization Kit was developed to improve the insulation against cold for UNHCR Family Tents.

The Winterization Kit includes:

- winterization liner
- partition
- chimney sleeve
- insulating mats
- floor protection (for the wooden stove)

All the components are fire retardant.

The winterization kit does not include any stove/heater or fuel. These items must be purchased separately, depending on the fuel type available in the area.



2 PERSONS



10 MINUTES



1 YEAR

* UNHCR Supply Catalogue - Item No 07223

** UNHCR Supply Catalogue - Item No 06648

TECHNICAL DRAWINGS

ROOF PLAN

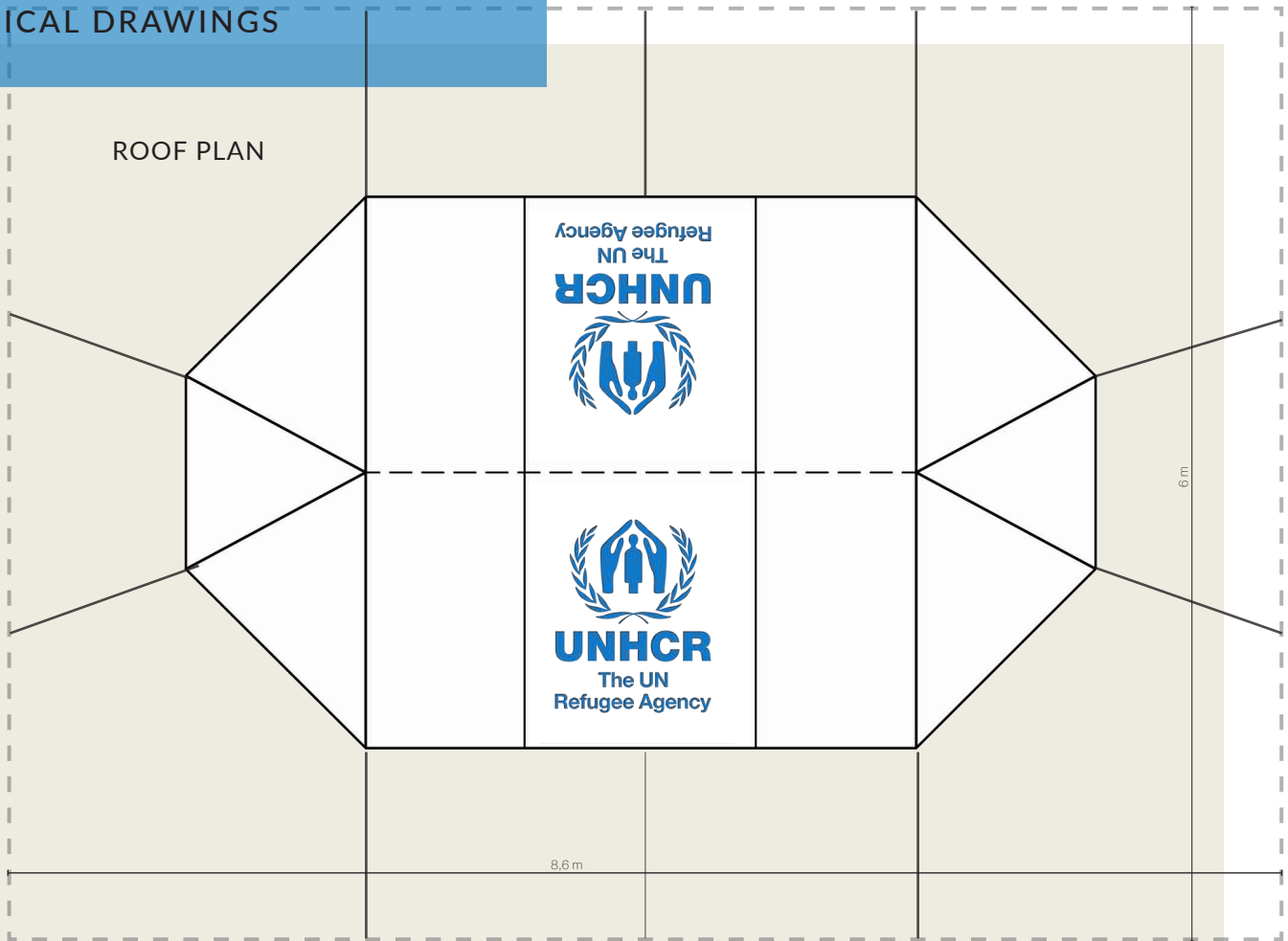

FRONT / BACK ELEVATION

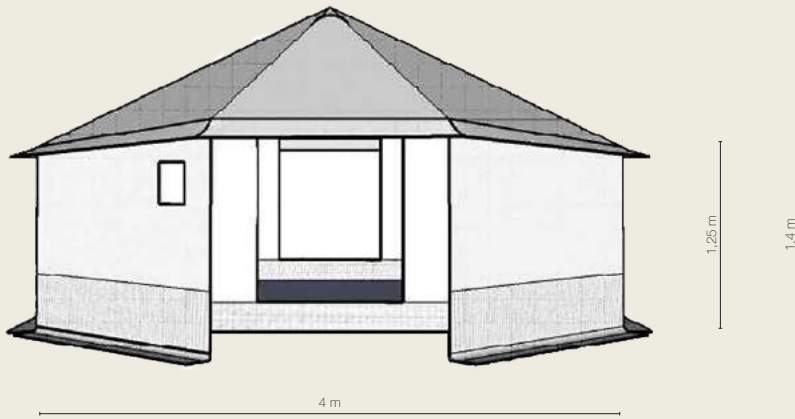

SIDE ELEVATION

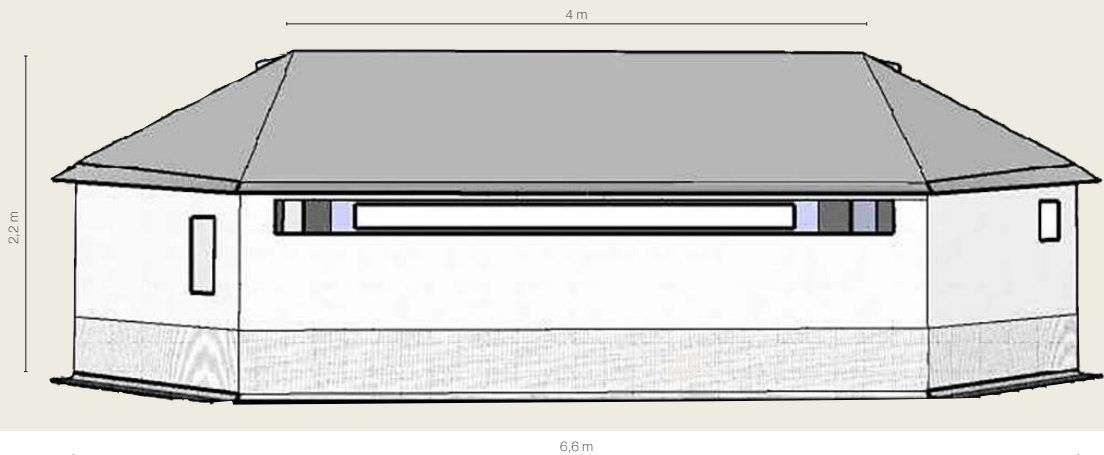

ASSEMBLY INSTRUCTIONS

x3



Ideal to assemble this tent.

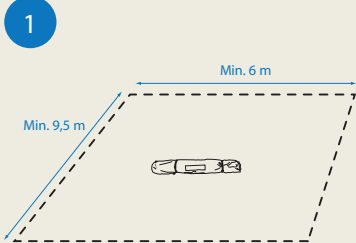

Place the package at the exact place where the tent will be erected.



Remove the bag.

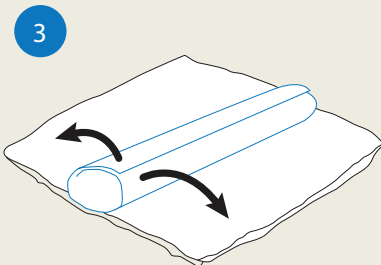

Unroll the bundle.

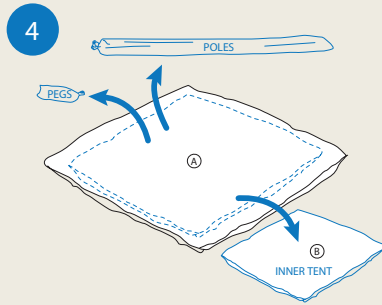

Take aside the bag with the poles and the accessories bag.

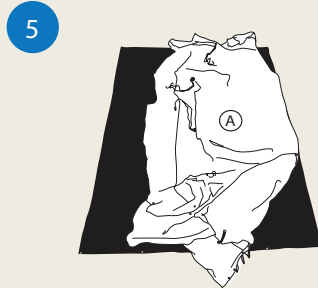

Unfold the outer tent canvas (the part made of heavy canvas, and carrying the ropes.)

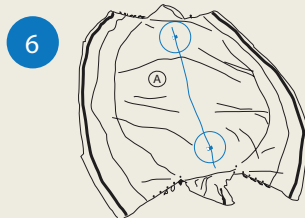

Place the outer tent canvas inside up to make the ridge line visible. To identify the ridge line, look for the two Velcro sleeves, and also see the two triangular vents at each end of the ridge.

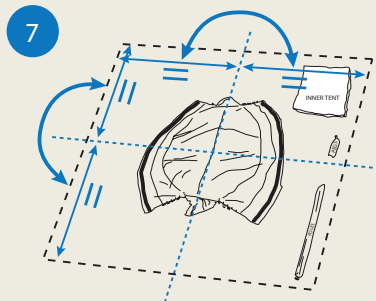

Align the tent canvas into the appropriate direction, according to the site planning.

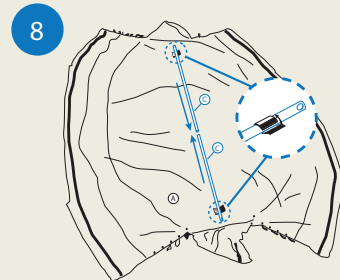

Assemble the ridge pole and place it on the tent canvas, attach it with the two Velcro sleeves.

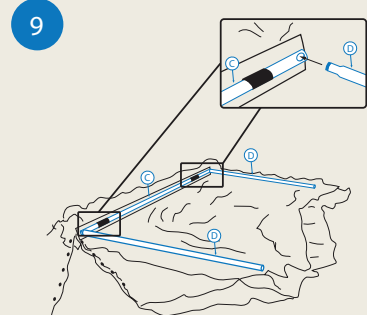

Place the two upright poles, one at each end of the ridge pole.

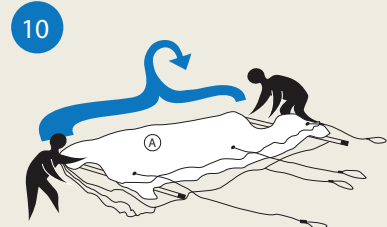

Fold back the outer tent canvas on the previously installed poles.

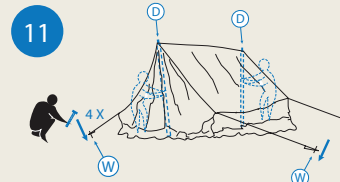

One person at each end taking the upright poles, pull up the tent. The third person places the 4 corner pegs into the ground as per the indication from the pitching plan, attaches and tensions the guy ropes of the 4 corners of the tent. At this stage the tent should stand up by itself.

12

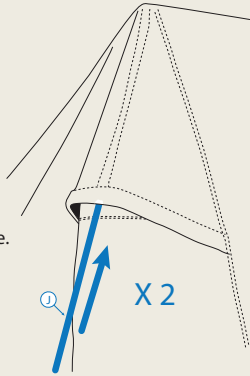

Ventilation cone. Place the rod in the sleeve.

13

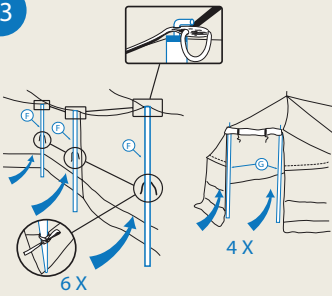

Place the 6 side poles and the 4 door poles on the inner side of the tent, attach them to the tent with the inside laces.

14

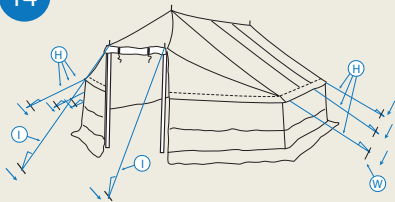

Place the remaining 6 pegs, attach and tension moderately all the guy ropes.

15

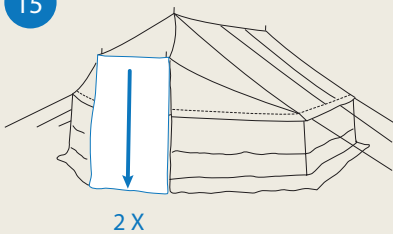

Close completely the 2 doors

16

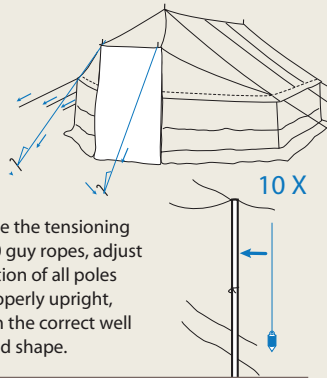

Complete the tensioning of the 10 guy ropes, adjust the position of all poles to be properly upright, to obtain the correct well tensioned shape.

17

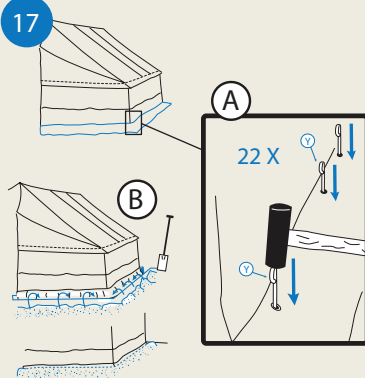

(A): Once the shape of the outer tent is appropriate, fix the bottom of the walls to the ground with 22 pegs, from outside.

(B): If possible, make a trench to bury the outer tent mud flap into the ground.

18

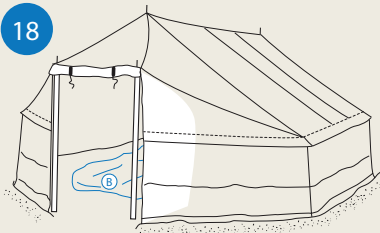

Open one door, get inside the tent, and unfold the inner tent.

19

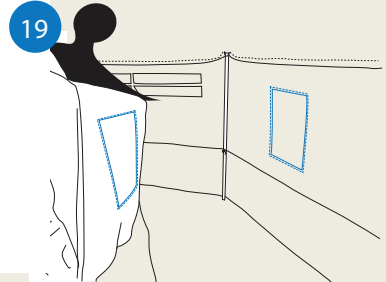

Turn the inner tent in a way that the position of the chimney pipe protection corresponds to the one on the outer tent.

20

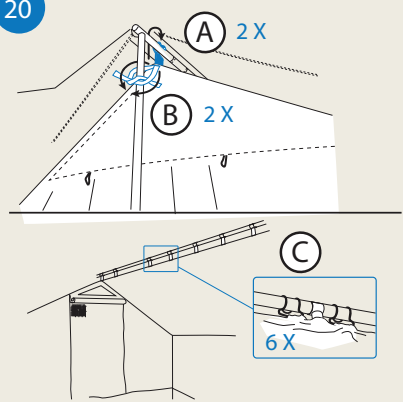

Hang the inner tent to the ridge pole, start first with only one hook at each end of the ridge pole (A), then attach the inner tent to the upright poles with the laces (B), and then place the remaining 6 hooks on the ridge pole (C).

21

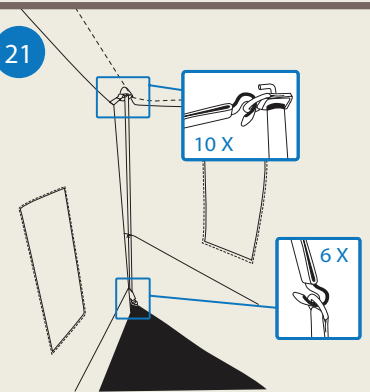

Hang the inner tent side walls to the side poles, using the 16 hooks and the 10 D-rings at the top and the 6 at the bottom of the walls. Start from the middle, and finish by the door side.

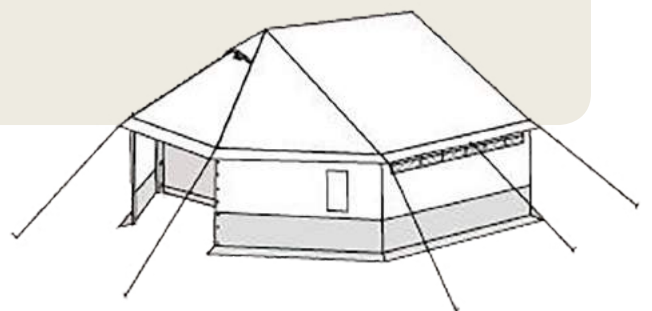

22

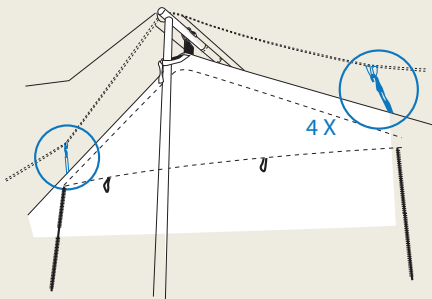

Attach the toggles to the loops at the top of each door zipper.

24

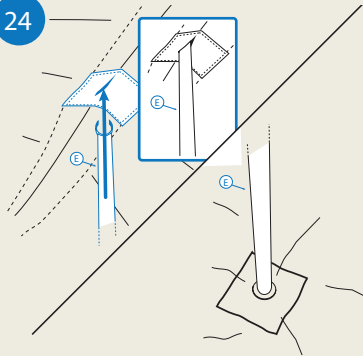

Place the central pole; make sure the base plate is located where the ground sheet is reinforced.

26

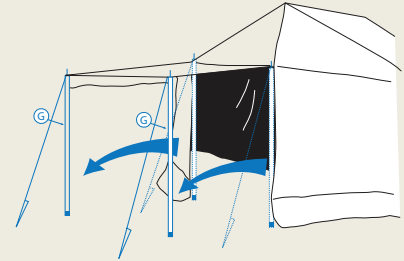

Outer tent doors can be used as awnings by moving the door poles, the door guy ropes and the pegs.

23

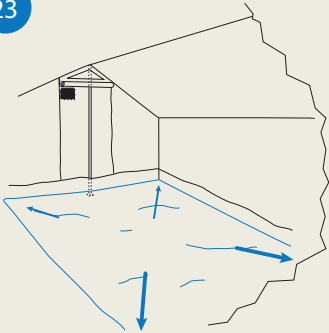

From inside the inner tent, flatten the ground sheet, and adjust the general shape of the inner tent.

25

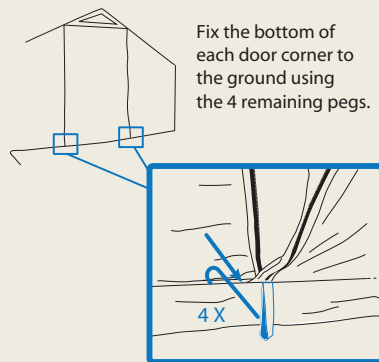

Fix the bottom of each door corner to the ground using the 4 remaining pegs.

27

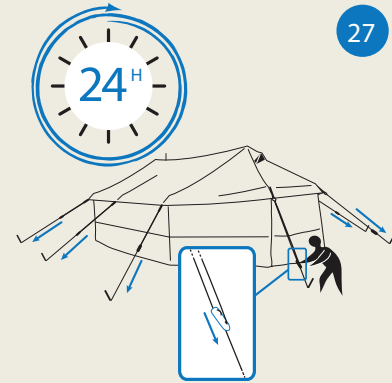

Check regularly the tensioning of the guy ropes and adjust if needed.

NOTES for STEPS 16 and 17

16 GUY ROPE TENSION

The grain of the wood runners to run lengthwise on the runner.

17 MUD FLAP

Whenever possible make a trench to bury the outer tent mud flap into the ground.



2.2 UNHCR FRAMED TENT

UNHCR Supply Catalogue - Item No 06642



40°C
5°C

3 PERSONS

30 MINUTES

1 YEAR

SHELTER DESCRIPTION

The Framed Tent is used by UNHCR, ICRC and IFRC and suitable for a family of 5 people, it is heavier and more expensive as compared to the standard Family tent, and meant for situations where the standard Family Tent is not the appropriate solution, being ideal to be used in urban areas.

This self-standing frame tent allows easy set up on hard surface, offers more inner volume, and requires a reduced surface area for erection, as compared to the standard Family Tent. Nevertheless, to assure a good wind resistance, the tent needs to be securely anchored to the ground with the provided guy ropes and pegs. The symmetric flaps offer the possibility to join 2 tents together lengthwise to create larger units.

DIMENSIONS

The outside dimension of the tent is 4.15m wide, 4m long and has a centre height of 2.4m.

PACKAGE

One tent with all accessories is packed in one bundle.

MATERIALS

The outer-tent roof and inner tent canvas is polyester-cotton blend and the groundsheet follows the plastic sheeting standard.

WEIGHT

Weight per unit is approximately 87kg.

VOLUME

Volume per unit is approximately 0,35 m3.

LIFE SPAN

The tent has a minimum 1 year lifespan, in moderate climates.

COST

The tent has an approximate cost of 700 US\$, excluding transport.

OPTION KITS

SHADE NET*

The shade net is an accessory for the standard Family Tent that is highly recommended in hot climate, to reduce the temperature inside the tent.

45°C
5°C

2 PERSONS

10 MINUTES

1 YEAR

WINTERIZATION KIT**

The Winterization Kit was developed to improve the insulation against cold for UNHCR Family Tents.

The Winterization Kit includes:

- winterization liner
- partition
- chimney sleeve
- insulating mats
- floor protection (for the wooden stove)

All the components are fire retardant.

The winterization kit does not include any stove/heater or fuel. These items must be purchased separately, depending on the fuel type available in the area.

45°C
0°C

2 PERSONS

10 MINUTES

1 YEAR

* UNHCR Supply Catalogue - Item No 07223

** UNHCR Supply Catalogue - Item No 06648

2.3 UNHCR SELF-STANDING FAMILY TENT



SHELTER DESCRIPTION

The new Self-Standing Family Tent is a result of joint Research and Development undertaken by UNHCR, IFRC and ICRC followed by field testing of three different tent designs. The outcome led to the development of the new self standing Family Tent with an improved dome design and new technical specifications.

IMPROVED DESIGN

The dome tent enhances living space and comfort.

SELF-SUPPORTING STRUCTURE

The tent is self-standing and self-tensioning.

SHADE NET

The included shade fly increases the thermal performance of tents in hot climates.

INNER PARTITION

The partition divides the tent into two inner autonomous spaces, providing families with an additional degree of privacy.

OUTER TENT

The outer provides good protection against dust, wind, rain, snow, insects and small fauna.

DIMENSIONS

The outside dimension of the tent is 4,3m wide, 4,3m long and has a centre height of 1.8m.

MATERIALS

The outer-tent roof is made of woven high-density polyethylene (HDPE) fibers, inner tent canvas is polyester-cotton canvas and the groundsheet follows the plastic sheeting standard.

FIRE RETARDANT

The tent has fire retardant properties.

WEIGHT

Weight per unit is approximately 55kg.

VOLUME

Volume per unit is approximately 0,35m3.

LIFE SPAN

The tent can be expected to have a minimum 1 year lifespan.

COST

The tent has an approximate cost of 420 US\$, excluding transport.

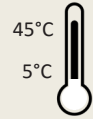

3 PERSONS



30 MINUTES



1 YEAR

OPTION KIT

WINTERIZATION KIT**

The Winterization Kit was developed to improve the insulation against cold for UNHCR Family Tents. The current winterization kits can be adapted to the new design to ensure thermal comfort in extreme cold conditions.

The Winterization Kit includes:

- winterization liner
- partition
- chimney sleeve
- insulating mats
- floor protection (for the wooden stove)

All the components are fire retardant.

The winterization kit does not include any stove/heater or fuel. These items must be purchased separately, depending on the fuel type available in the area.



2 PERSONS



10 MINUTES



1 YEAR

* UNHCR Supply Catalogue - Item No 07223

** UNHCR Supply Catalogue - Item No 06648

TECHNICAL DRAWINGS

ROOF PLAN

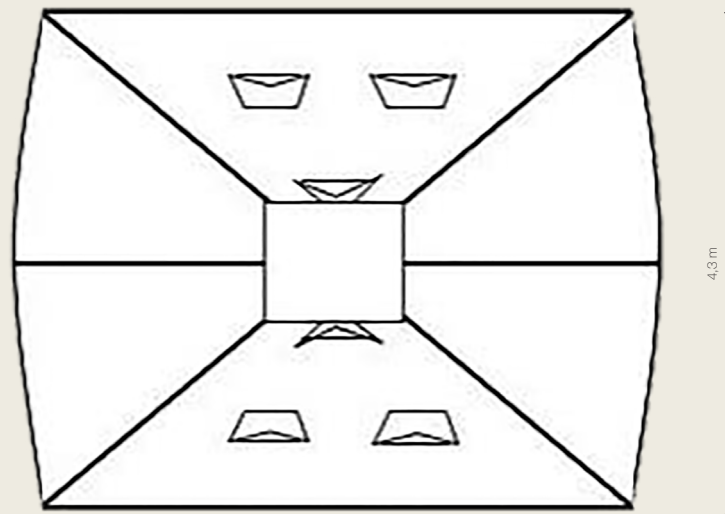

FRONT ELEVATION

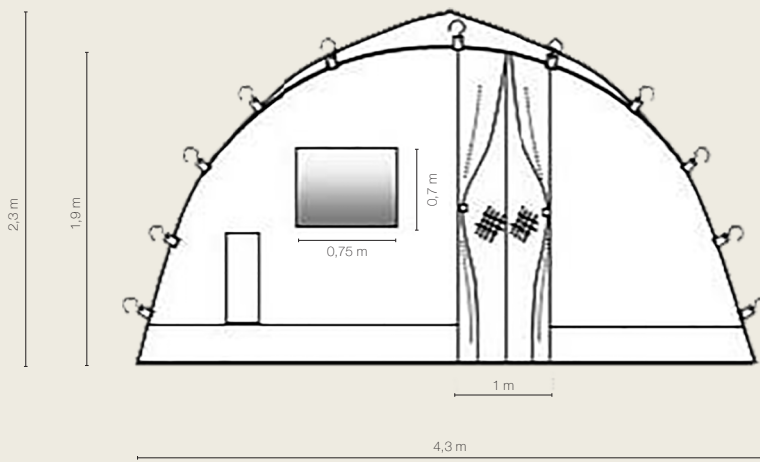

SIDE ELEVATION

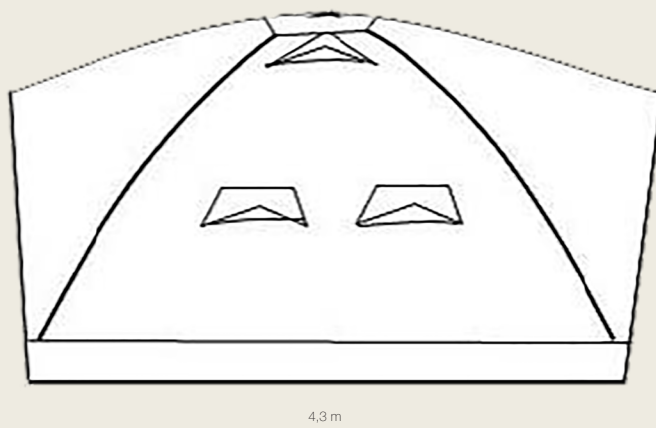

ASSEMBLY INSTRUCTIONS



Ideal to assemble this tent.

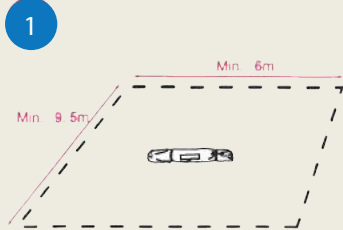

Place the package at the exact place where the tent will be erected.



Remove the bag.

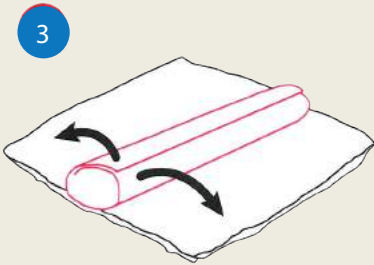

Unroll the bundle.

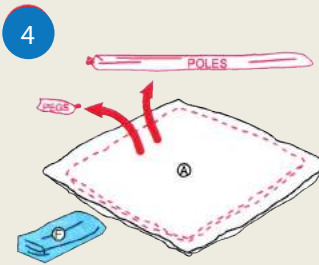

Take aside the bag with the poles and the accessories bag.

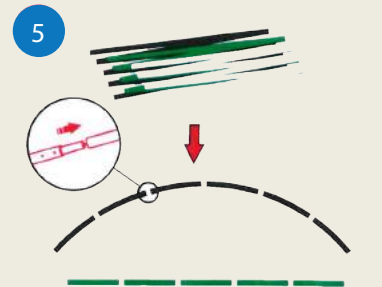

Each section should joint well in together.

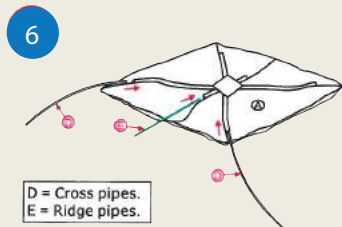

D = Cross pipes.
E = Ridge pipes.

Pass through the poles to their corresponding sleeves.



Insert D pole tips to base plate.



Insert end pipes tips to base plate, and fix the tent + pole E hooks on it.

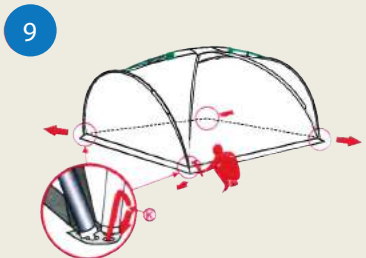

Pull corners to tension the groundsheet and fix peg K on base plates

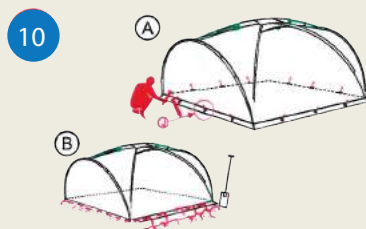

A: Fix peg J on tent around.
B: If possible, digging a trench and bury the tent mudflap into the ground.

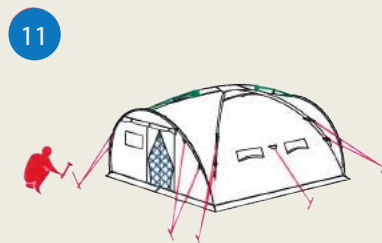

Use the large T pegs for the four corner big ropes. Use type K for other ropes.

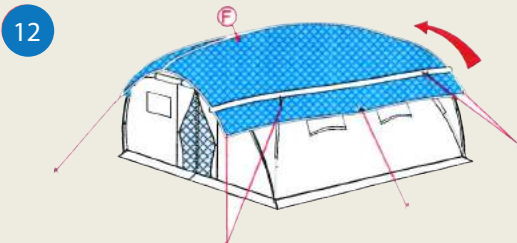

The tent main guy ropes to pass through the 4 slots of shade net, and fix the remaining guy ropes to the tent pegs.



FIRE SAFETY

PREVENTION

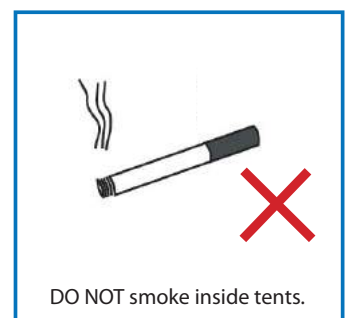
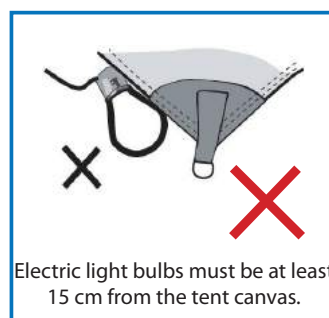
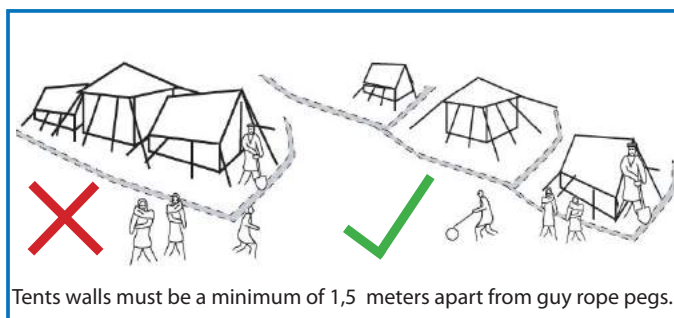
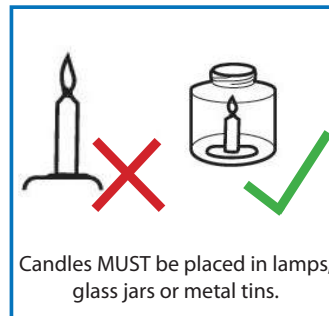

2.4 REFUGEE HOUSING UNIT



SHELTER DESCRIPTION

The Refugee Housing Unit (RHU) is an innovative shelter solution designed as a result of a research & development project undertaken by Better Shelter, Sweden, and UNHCR with the support of the IKEA Foundation.

The RHU is composed of several basic elements, including a lightweight steel frame, roof and wall panels, door and windows, floor covering, solar energy system (lamp and telephone charger) and an innovative anchoring system.

FLOOR AREA

17,5 m²

MINIMUM CEILING HEIGHT

1,84 m

DOOR

1 piece (0,74 x 1,69 m)

WINDOWS

4 pieces (6,2 m²)

VENTILATION OPENINGS

2 pieces (8 m²)

WIND SPEED (frame)

18 m/s (EC1)

SNOW LOADS

10 kg/m² (EC1)

UV

2700 UVA

UNIT PRICE

1,150 US\$, exclusive of transport and storage

EXPECTED LIFESPAN

1,5 years - without maintenance

3 years - with maintenance

MODULAR

Yes

PV SYSTEM

4h light/day and USB power

PACKAGE WEIGHT

160 kg

PACKAGE VOLUME

1,07 m³

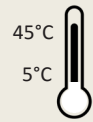

4 PERSONS



5-6 HOURS



3 YEARS

OPTION KIT

WINTERIZATION KIT

Under development

WIND KIT

Under development

SHADE NET KIT

Under development



TECHNICAL DRAWINGS

ROOF PLAN



FRONT ELEVATION



BACK ELEVATION



SIDE ELEVATION



FRAME

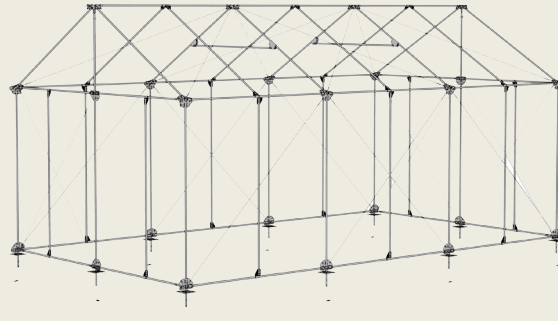

Weight	30-45 kg
Volume	0,1 m ³
Assembly	1 hour / 2 people
Life span	10+ years

PANELS



Weight	85 kg
Volume	0,8 m ³
Assembly	3 hours / 2 people
Life span	3 years

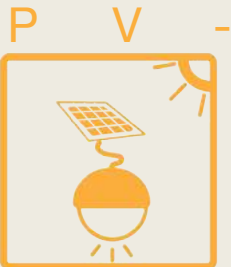

Weight	0,75 kg
Volume	0,01 m ³
Assembly	10 min / 2 people
Life span	3 years





3. EMERGENCY SHELTER DESIGNS

3.1 WOODEN GABLE FRAME SHELTER

WITH DIFFERENT CLADDINGS



SHELTER DESCRIPTION

This emergency shelter project was developed in Ajuong Thok refugee camp - South Sudan - with the objective of providing adequate shelter for the camp population and new arrivals using local, available materials. Two characteristics of the area and population worked as main guiding factors for the strategy: the refugees were from rural areas and have shelter coping skills; the region has large forest and thatch grass resources.

LOCATION: Ajuong Thok, South Sudan

PROJECT DATE: January 2013

SHELTER SIZE: 12 m² (option)

TIME TO BUILD: depending on the phase, from emergency to durable, 6 hours - 3 days

LIFESPAN: depending on the phase, from emergency to durable, 1 - 5 years

CONSTRUCTION TEAM: 1 skilled + 2 labours

COST PER SHELTER: depending on the phase, from emergency to durable. Transport cost may have significant impact in remote areas.

DESIGN OPTIONS

SIZE OPTIONS

3 x 4 m | 3 x 5 m | 4 x 5 m

FOOTING OPTIONS

30 cm deep (plain concrete | compacted earth)

STRUCTURE OPTIONS

Bushwood | Timber | Bamboo

ROOF MATERIAL OPTIONS

Tarpaulin | Thatch | Corrugated iron

WALL MATERIAL OPTIONS

Tarpaulin | Grass cladding | Mud plastering | Bamboo

FLOOR OPTIONS

Tarpaulin | Local natural material mat | platform

PARTITION

Possible to divide the shelter in two rooms

WINDOWS

Possible to create two openings

DOOR

Minimum 90 x 170 m

VENTILATION

Recommended to create two openings

COOKING

Open fire not recommended inside models I, II, III



TECHNICAL DRAWINGS

FLOOR PLAN

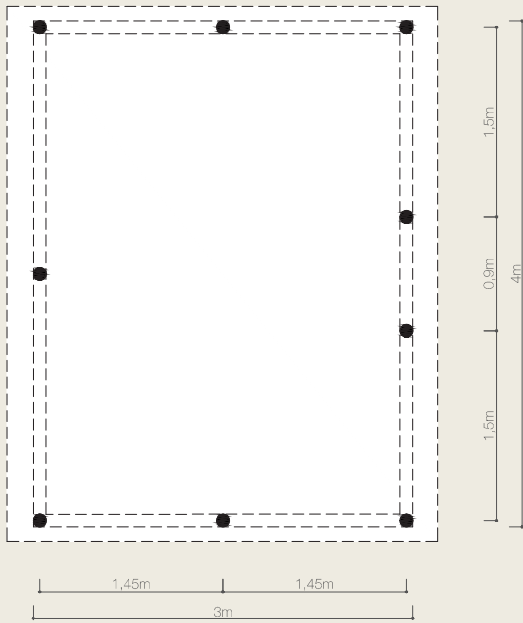

ROOF PLAN

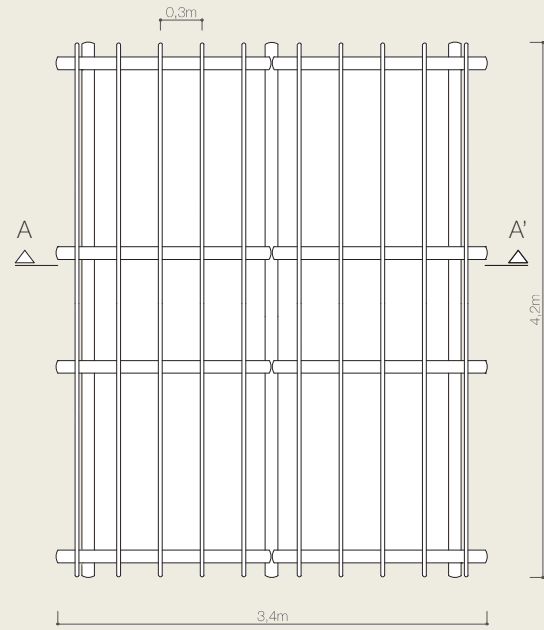

FRONT ELEVATION

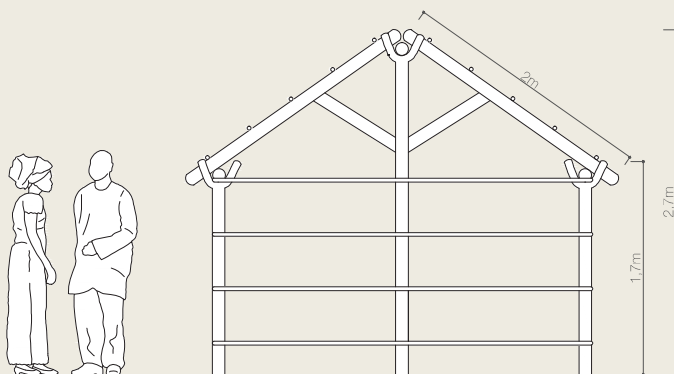

SECTION A-A'

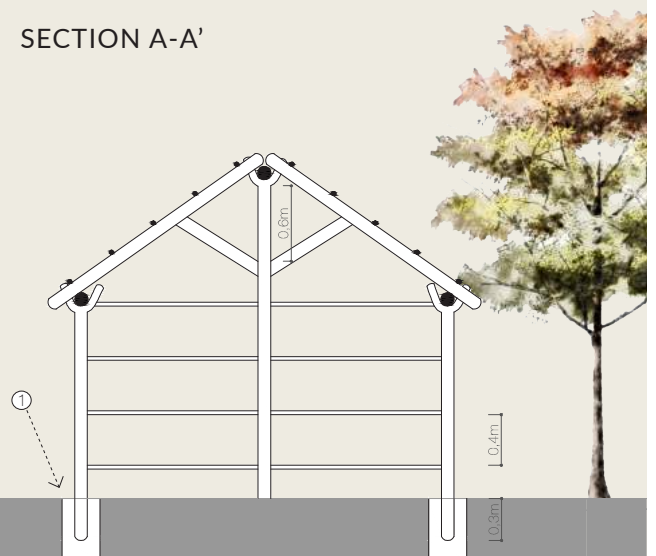

① termite treatment recommended in certain regions



MODEL I



The first model of this Emergency Shelter is here composed by a rectangular wooden structure, using local available materials, in this case wood poles and bush sticks. UNHCR tarpaulin, either five 4x5m sheets or equivalent length of roll*, will cover the floor, walls and roof. The shelter has a covered living area of 12m² (4x3 m), and could be increased depending on the number of family members.

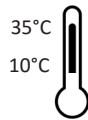

BILL OF QUANTITIES

Item	Specifications	Unit	Qty	Unit Cost US\$	Total US\$
UNHCR plastic sheeting	4 m x 5 m	pieces	5	12	60
Local poles (with bracket)	2 m length, Ø 8-15 cm	pieces	8	2	16
Local poles (with bracket)	3 m length, Ø 8-15 cm	pieces	2	2	4
Local poles	4,2 m length, Ø 8-15 cm	pieces	2	2,50	5
Local poles (rafters)	2,2 m length, Ø 8-15 cm	pieces	6	2	12
Local poles (trusses)	0,8 m length, Ø 6-8 cm	pieces	4	1	4
Bush sticks	3 m length, Ø 2-3 cm	bundle	8	2,50	20
Local rope / tire	5 mm	bundle	12	1	12
Nails	100 mm	Kg	3	2	6
Nails	75 mm	kg	3	1,5	4,5
Local door	bush sticks braiding, 0,9 x 1,7 m	pieces	1	5	5
Local window	bush sticks braiding, 0,6 x 0,4 m	pieces	2	2,5	5

Sub total	154 \$
Transport cost 15 %	23 \$
Labour cost 30 %	46 \$
Total estimated cost *	223 \$

* Tarpaulin roll - 4 x 50 m, US\$ 100

** these costs are based on a 2012 market survey in South Sudan

MODEL II



The second model of the Emergency Shelter consists of the same rectangular wooden structure with the floor and roof covered by UNHCR tarpaulin, either 3 plastic sheets or equivalent length of roll*. The walls in this unit are covered by thatch cladding. The shelter has a covered living area of 12m² (4x3 m) and a minimum height of 1,7m.

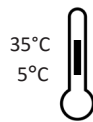

BILL OF QUANTITIES

Item	Specifications	Unit	Qty	Unit Cost US\$	Total US\$
UNHCR plastic sheeting	4 m x 5 m	pieces	3	12	36
Local poles with bracket	2 m length, Ø 8-15 cm	pieces	8	2	16
Local poles with bracket	3 m length, Ø 8-15 cm	pieces	2	2	4
Local poles	4,2 m length, Ø 8-15 cm	pieces	2	2,50	5
Local poles (rafters)	2,2 m length, Ø 8-15 cm	pieces	6	2	12
Local poles (trusses)	0,8 m length, Ø 6-8 cm	pieces	4	1	4
Bush sticks	3 m length, Ø 2-3 cm	bundle	8	2,50	20
Thatch cladding	2 m length	bundle	14	2	28
Local rope / tire	5 mm	bundle	12	1	12
Nails	100 mm	Kg	3	2	6
Nails	75 mm	kg	3	1,5	4,5
Local door	bush sticks braiding , 0,9 x 1,7 m	pieces	1	5	5
Local window	bush sticks braiding , 0,6 x 0,4 m	pieces	2	2,5	5

Sub total	158 \$
Transport cost 15 %	24 \$
Labour cost 30 %	47 \$
Total estimated cost *	229 \$

* Tarpaulin roll - 4 x 50 m, US\$ 100

** these costs are based on a 2012 market survey in South Sudan

MODEL III



The third model of the Emergency Shelter is here composed by a rectangular wooden structure. The floor is covered by UNHCR tarpaulin; and walls composed by thatch cladding.

The gable roof of the unit is covered by corrugated iron sheets and a metallic ridge cap. The shelter has a covered living area of 12m² (4x3 m) and a minimum height of 1,7m.

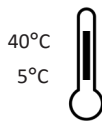

BILL OF QUANTITIES

Item	Specifications	Unit	Qty	Unit Cost US\$	Total US\$
UNHCR plastic sheeting	4 m x 5 m	pieces	1	12	12
Local poles with bracket	2 m length, Ø 8-15 cm	pieces	8	2	16
Local poles with bracket	3 m length, Ø 8-15 cm	pieces	2	2	4
Local poles	4,2 m length, Ø 8-15 cm	pieces	2	2,50	5
Local poles (rafters)	2,2 m length, Ø 8-15 cm	pieces	6	2	12
Local poles (trusses)	0,8 m length, Ø 6-8 cm	pieces	4	1	4
Bush sticks	3 m length, Ø 2-3 cm	bundle	8	2,50	20
Thatch cladding	2 m length	bundle	14	2	24
Corrugated galvanized iron	0,92 m x 3 m	sheets	6	5	30
Metallic roof cap	0,2 m x 0,3 m	pieces	20	2	40
Local rope / tire	5 mm	bundle	12	1	12
Nails	100 mm	Kg	3	2	6
Nails	75 mm	kg	3	1,5	4,5
Nails (roofing)	64 mm; with rubber washer	kg	3	2	6
Local door	bush sticks braiding , 0,9 x 1,7 m	pieces	1	5	5
Local window	bush sticks braiding , 0,6 x 0,4 m	pieces	2	2,5	5

Sub total	206 \$
Transport cost 15%	31 \$
Labour cost 30%	62 \$
Total estimated cost *	299 \$

* these costs are based on a 2012 market survey in South Sudan

MODEL IV



The fourth model of the Emergency Shelter consists here of the same rectangular wooden structure with the UNHCR tarpaulin covered floor. The gable roof of the unit is covered by corrugated iron and a metallic ridge cap. The walls of this unit are based on the adobe plastering technology with bush sticks as plaster support. There is the option to mud plaster both interior and external walls, or only the external. The shelter has a covered living area of 12m² (4x3 m) and a minimum height of 1,7m.

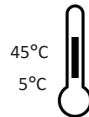

BILL OF QUANTITIES

Item	Specifications	Unit	Qty	Unit Cost US\$	Total US\$
UNHCR plastic sheeting	4 m x 5 m	pieces	1	12	12
Local poles with bracket	2 m length, Ø 8-15 cm	pieces	8	2	16
Local poles with bracket	3 m length, Ø 8-15 cm	pieces	2	2	4
Local poles	4,2 m length, Ø 8-15 cm	pieces	2	2,50	5
Local poles (rafters)	2,2 m length, Ø 8-15 cm	pieces	6	2	12
Local poles (trusses)	0,8 m length, Ø 6-8 cm	pieces	4	1	4
Bush sticks	3 m length, Ø 2-3 cm	bundle	8	2,50	20
Thatch cladding	2 m length	bundle	14	2	24
Corrugated galvanized iron	0,92 m x 3 m	sheets	6	5	30
Metallic roof cap	0,2 m x 0,3 m	pieces	20	2	40
Mud	Excavation / Sourcing	m ³	5	(labour cost)	20
Local rope / tire	5 mm	bundle	12	1	12
Nails	100 mm	Kg	3	2	6
Nails	75 mm	kg	3	1,5	4,5
Nails (roofing)	64 mm; with rubber washer	kg	3	2	6
Local door	bush sticks braiding , 0,9 x 1,7 m	pieces	1	5	5
Local window	bush sticks braiding , 0,6 x 0,4 m	pieces	2	2,5	5

Sub total	226 \$
Transport cost 5%	34 \$
Labour cost 30%	68 \$
Total estimated cost **	328 \$

* these costs are based on a 2012 market survey in South Sudan

MODEL V



The fifth model of the Emergency Shelter consists here of the same rectangular wooden structure with the UNHCR tarpaulin covered floor. The gable roof of the unit is covered by corrugated iron sheets and thatch. The walls of this unit are based on the adobe plastering technology. The shelter has a covered living area of 12m² (4x3 m) and a minimum height of 1,7m.

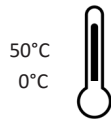

BILL OF QUANTITIES

Item	Specifications	Unit	Qty	Unit Cost US\$	Total US\$
UNHCR plastic sheeting	4 m x 5 m	pieces	1	12	12
Local poles with bracket	2 m length, Ø 8-15 cm	pieces	8	2	16
Local poles with bracket	3 m length, Ø 8-15 cm	pieces	2	2	4
Local poles	4,2 m length, Ø 8-15 cm	pieces	2	2,50	5
Local poles (rafters)	2,2 m length, Ø 8-15 cm	pieces	6	2	12
Local poles (trusses)	0,8 m length, Ø 6-8 cm	pieces	4	1	4
Bush sticks	3 m length, Ø 2-3 cm	bundle	8	2,50	20
Thatch cladding	2 m length	bundle	14	2	24
Corrugated galvanized iron*	0,92 m x 3 m	sheets	6	5	30
Metallic roof cap	0,2 m x 0,3 m	pieces	20	2	40
Thatch roofing	2 m length	bundle	6	5	30
Mud	Excavation / Sourcing	m ³	5	(labour cost)	20
Local rope / tire	5 mm	bundle	12	1	12
Nails	100 mm	Kg	3	2	6
Nails	75 mm	kg	3	1,5	3
Nails (roofing)	64 mm; with rubber washer	kg	3	2	6
Local door	bush sticks braiding, 0,9 x 1,7 m	pieces	1	5	5
Local window	bush sticks braiding, 0,6 x 0,4 m	pieces	2	2,5	5

Sub total	254 \$
Transport cost 15%	38 \$
Labour cost 30%	76 \$
Total estimated cost **	368 \$

* it is possible to replace the iron sheets by UNHCR tarpaulin sheeting
 ** these costs are based on a 2012 market survey in South Sudan

3.2 TUAREG SHELTER



SHELTER DESCRIPTION

This emergency shelter project was developed in Burkina Faso targeting mainly nomad refugees from the northern part of Mali.

The objective of the project was to provide Shelter support to Malian refugees living in camps in order to reduce vulnerability to protection and settlement issues within the camp.

Using the traditional shelter model ensured the continuation of the traditional role of Tuareg women in the construction of their shelter. The nomadic mobile structure permitted that each shelter could be dismantled and moved to another location.

Beneficiary selection and materials distribution was done through the existing social/ tribal structure of the refugee Tuareg communities.

The shelter kits comprised materials to construct different sizes of shelters based on the family size.

LOCATION: Burkina Faso

PROJECT DATE: 2012

SHELTER SIZE: 21 m²

TIME TO BUILD: 1 day

LIFESPAN: 2 years

CONSTRUCTION TEAM: 3 people



MATERIALS

ROOF COVERING MATERIAL

Covering material was provided to provide water proofing and protection from the extreme heat of the Burkina Faso weather. Traditional roof covering material (tanned goat skin) was replaced with plastic tarpaulin due to its unavailability in the local markets.

EUCALYPTUS POLES

These make up the frame of the structure on which the roof and wall covering material are attached with ropes. The vertical members are larger and the roof members are more flexible to give the roof its dome shape.

FIXING ROPE

These are synthetic or local rope used to attach the timber poles for the roof and the walls together and attached the mats to the timber poles as well as the roof covering material to the roof and wall timber poles.

MATS

Mats are used to cover the walls of the shelter. Straw mats were distributed, although synthetic mats or plastic sheeting are recommended as they last longer and are more resistant.

TECHNICAL DRAWINGS

FLOOR PLAN

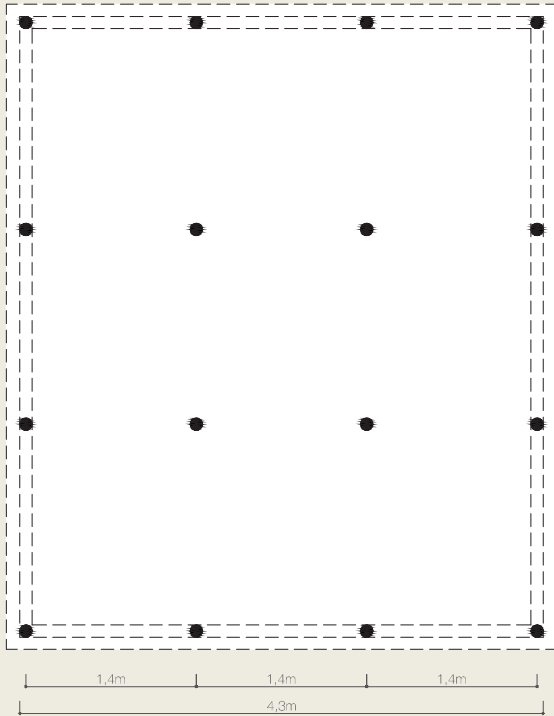

ROOF PLAN

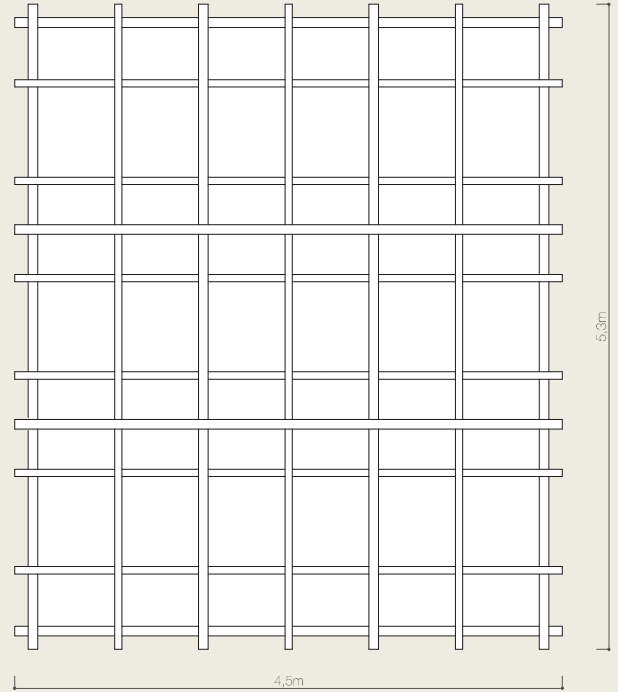

SIDE ELEVATION

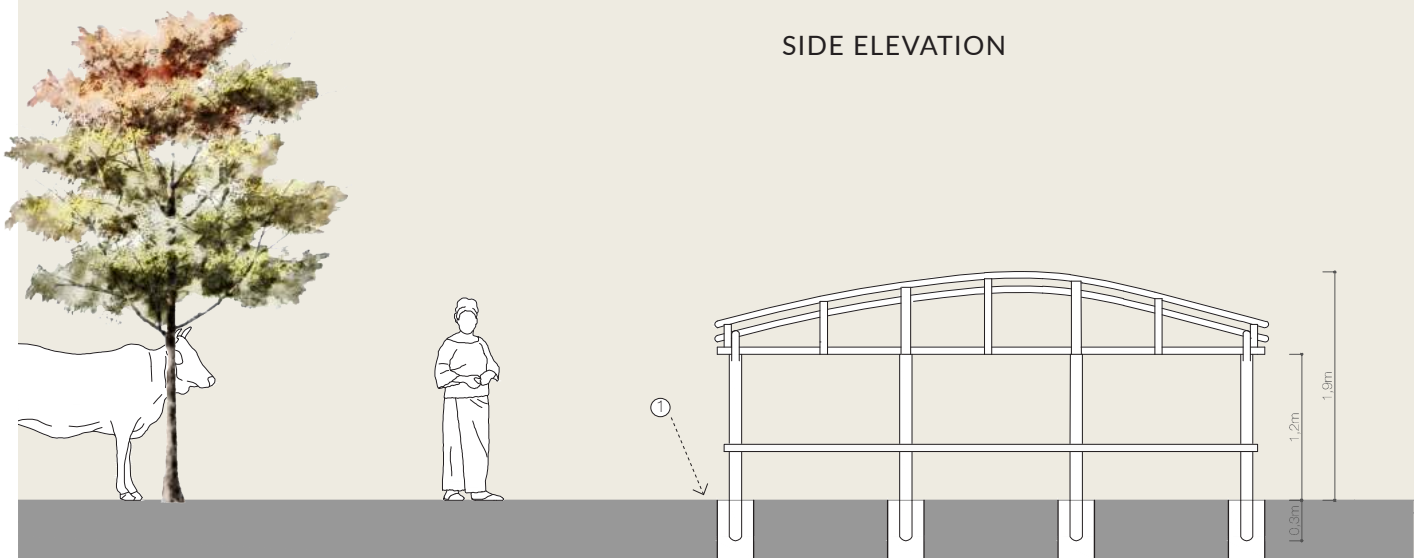

① termite treatment recommended in certain regions



MODEL I

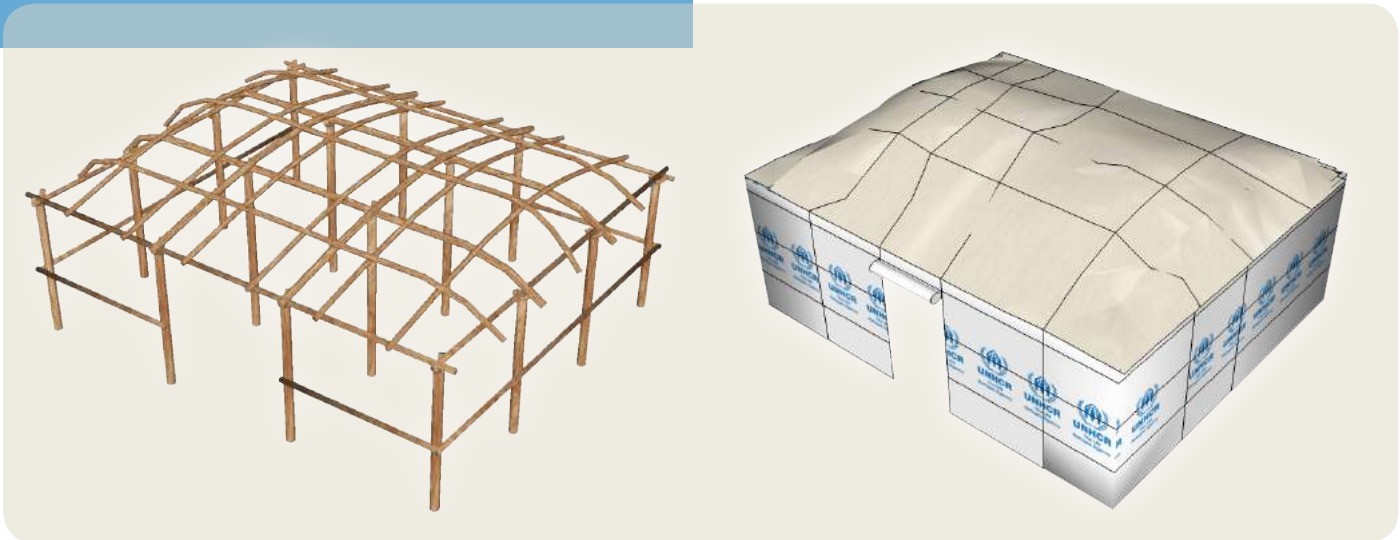

This Emergency Shelter consists of a rectangular wooden structure with the walls and roof covered by UNHCR tarpaulin. Green wood poles form a grid of arches and semi arches intersecting to form a shell like structure to carry the covering materials. The shelter has a covered living area of 21m² (4,2x5 m) and the height varies from 1,2 to 1,7 m.

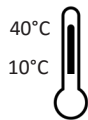

BILL OF QUANTITIES

Item	Specifications	Unit	Qty	Unit Cost US\$	Total US\$
Eucalytus Poles	Green wood. 4 m length, Ø 8-12 cm	pieces	16	2	32
Eucalytus Poles	Green wood. 3 m length, Ø 4-8 cm	pieces	8	1,5	12
Eucalytus Poles	Green wood. 4 m length, Ø 2-6 cm	pieces	24	1	24
Synthetic Rope	20 m length, Ø 0,3 cm	roll	2	8	16
Synthetic Rope	30 m length, Ø 0,8 cm	roll	1	12	12
UNHCR plastic sheeting	4 m x 5 m	pieces	4	16,5	66
Plastic mats	1,2 x 2,5 m	pieces	8	8	36

Sub total	198 \$
Transport cost 15 %	30 \$
Labour cost 30 %	60 \$
Total estimated cost *	288 \$

* these costs are based on a 2012 market survey in Burkina Faso

MODEL II



This Emergency Shelter consists of a rectangular wooden structure with the walls and roof covered by UNHCR tarpaulin and straw mats. Green wood poles form a grid of arches and semi arches intersecting to form a shell like structure to carry the covering materials. The shelter has a covered living area of 21m² (4,2x5 m) and the height varies from 1,2 to 1,7 m.

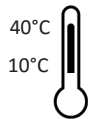

BILL OF QUANTITIES

Item	Specifications	Unit	Qty	Unit Cost US\$	Total US\$
Eucalytus Poles	Green wood. 4 m length, Ø 8-12 cm	pieces	16	2	32
Eucalytus Poles	Green wood. 3 m length, Ø 4-8 cm	pieces	8	1,5	12
Eucalytus Poles	Green wood. 4 m length, Ø 2-6 cm	pieces	18	1	18
Synthetic Rope	20 m length, Ø 0,3 cm	roll	2	8	16
Synthetic Rope	30 m length, Ø 0,8 cm	roll	1	12	12
Straw mats	1 x 1,8 m	pieces	5	20	100
UNHCR plastic sheeting	4 m x 5 m	pieces	2	16,5	33
Plastic mats	1,2 x 2,5 m	pieces	8	8	36

Sub total	259 \$
Transport cost 15 %	39 \$
Labour cost 30 %	78 \$
Total estimated cost *	376 \$

* these costs are based on a 2012 market survey in Burkina Faso

3.3 TUAREG TENT



SHELTER DESCRIPTION

This emergency shelter project was developed in Sahrawi refugees' camps in Tindouf.

The tents provided were composed of canvas, blended cloth, iron pegs and bamboo poles in addition to cotton rope.

The tent has around 49m² with a foot print of 121 m².

LOCATION: Algeria

PROJECT DATE: October 2012

SHELTER SIZE: 49 m²

TIME TO BUILD: 1 day

LIFESPAN: 2 years

CONSTRUCTION TEAM: 3 people



DESIGN OPTIONS

SIZE OPTIONS

5 x 5 m | 6 x 6 m | 7 x 7 m

FOOTING OPTIONS

30 cm deep (plain concrete | compacted earth)

STRUCTURE OPTIONS

Bamboo | Timber | Metal

WALL MATERIAL OPTIONS

Canvas for exterior and Blended cloth for interior (UNHCR supply catalogue)

FLOOR OPTIONS

Tarpaulin | Local natural material mat

WINDOWS

Possible to create openings

DOOR

Minimum 90 x 170 m

VENTILATION

Possible and recommended to create two openings



MATERIALS

CANVAS SHEET

Every beneficiary benefitted from 70x1.5 m of Canvas sheet which allowed building Sahrawi traditional tents. The quality of the canvas was appreciated by the majority of the beneficiaries, especially in terms of resistance to hot/cold climate and water proofing. Cotton sewing was also distributed to strengthen patches in some parts of the tents, where there are additional stresses such as where the wall roof and doorways or windows are joined.

BLENDED CLOTH

The beneficiaries benefitted from 70x1.5 m of blended cloth, which quality and color were highly appreciated.

IRON PEGS

Where windstorms are frequent is recommended to strengthen the tents allocating 8 pegs in every side of the tent, 28 in total (for the 7x7m tent).

BAMBOO POLES

With a pin in the end on a rivet of 12 cm in length at the top of the bamboo pole.

COTTON ROPE

Rope is required to be distributed per shelter to withstand in extreme wind conditions.

TECHNICAL DRAWINGS

FLOOR PLAN

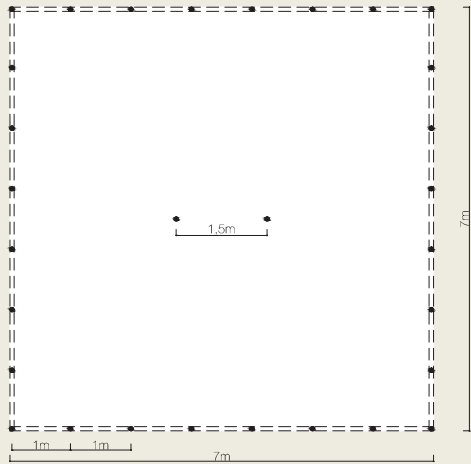

ROOF PLAN with CANVAS COVER

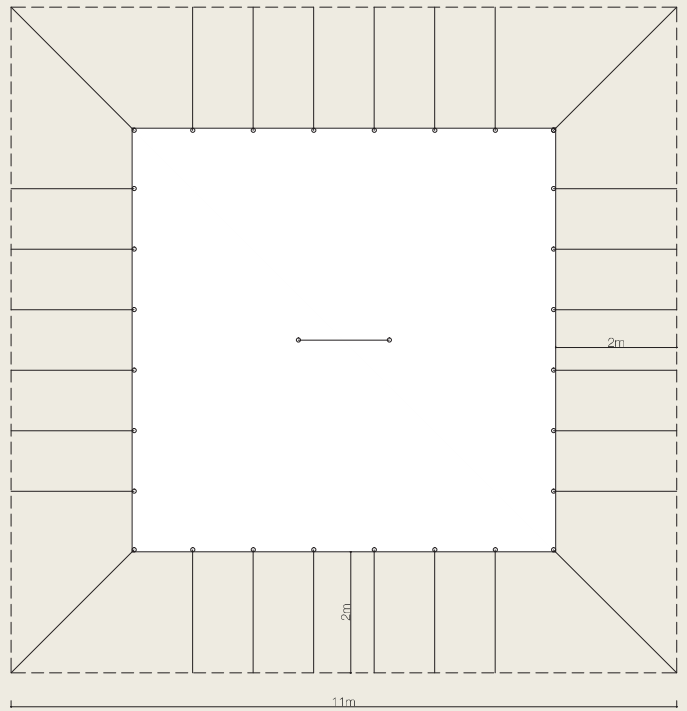

FRONT ELEVATION

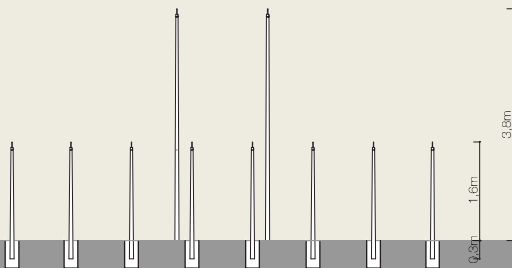

FRONT ELEVATION with CANVAS COVER

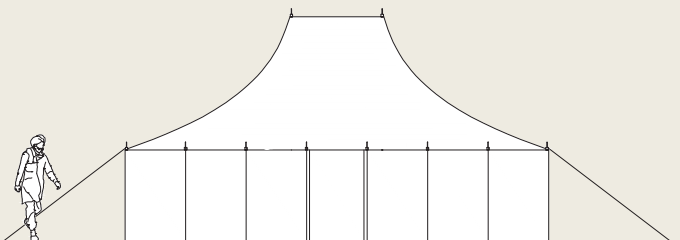

MODEL



This Emergency Shelter consists of a bamboo poles' structure with a double wall and roof covering. Cotton canvas for the exterior and blended cloth for the inside. The shelter has a covered living area of 49m² (7x7 m) and the height varies between 1,5 (eve level) and 3,7 m.

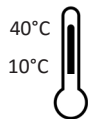

BILL OF QUANTITIES

Item	Specifications	Unit	Qty	Unit Cost US\$	Total US\$
Cotton canvas *	Beige - green olive, 1,5 x 70 m	pieces	2	216,5	433
Blended cloth	Cotton, Green wood. 1,5 x 70 m	pieces	2	72	144
Cotton rope	50 m length, Ø 0,12 cm	pieces	1	28	28
Bamboo poles	4 m length, Ø 4-7 cm	pieces	2	6	12
Bamboo poles	1,8 m length, Ø 4-7 cm	pieces	28	3	84
Rivet pin	12 cm lenght	pieces	30	3,25	97,5
Iron pegs	50 cm length, Ø 1,5 cm	pieces	28	0,8	22,4

Sub total	821 \$
Transport cost 15 %	123 \$
Labour cost 30 %	246 \$
Total estimated cost **	1190 \$

* UNHCR Supply Catalogue - Item No 05353

** these costs are based on a 2015 market survey in Algeria

3.4 TUKUL SHELTER



SHELTER DESCRIPTION

The Tukul emergency shelter is a traditional type of structure which utilizes simple building techniques and was developed in all states of South Sudan.

This type of shelter has very good resisting properties against strong winds; good installation against heat and was generally accepted by beneficiaries. It requires periodical maintenance.

It constitutes a basic temporary accommodation for 4 to 6 persons, using locally available materials.

LOCATION: South Sudan

PROJECT DATE: 2012

SHELTER SIZE: 21,6 m²

TIME TO BUILD: 1 day

LIFESPAN: 2-4 years

CONSTRUCTION TEAM: 3 people



DESIGN OPTIONS

SIZE OPTIONS

Shelter diameter: 5,25 m (with surface area of 21,6 m²) | 10 m (these mega tukuls are suitable to serve as collective shelters in case of emergence)

FOOTING OPTIONS

30 cm deep (plain concrete | compacted earth)

STRUCTURE OPTIONS

Bushwood | Timber | Bamboo

ROOF MATERIAL OPTIONS

Tarpaulin | Thatch

WALL COVER MATERIAL OPTIONS

Tarpaulin | Grass cladding | Mud plastering | Bamboo sticks

FLOOR OPTIONS

Tarpaulin | Local natural material mat | platform

WINDOWS

Possible to create openings

DOOR

Minimum 90 x 160 cm, depending on the round wall height

VENTILATION

Possible and recommended to create a gap (approximately 150 mm) between mud wall and roof thatch for ventilation and light

TECHNICAL DRAWINGS

FLOOR PLAN

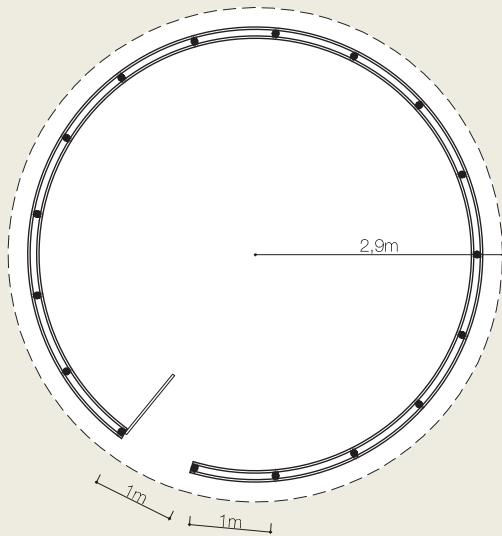

ROOF PLAN

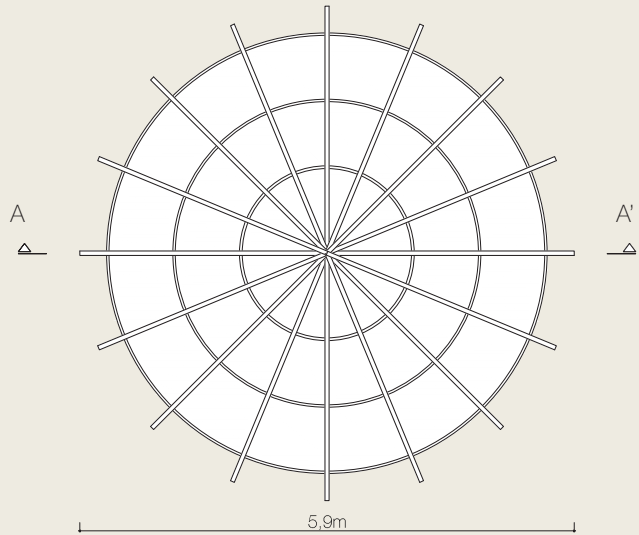

FRONT ELEVATION

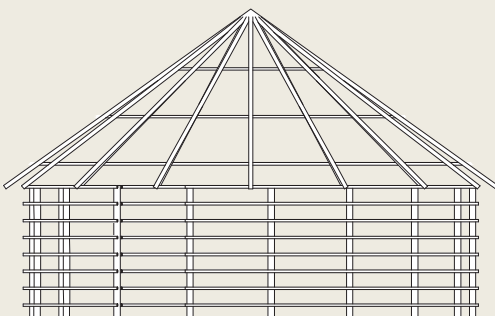

SECTION A-A'

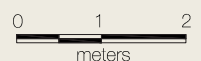
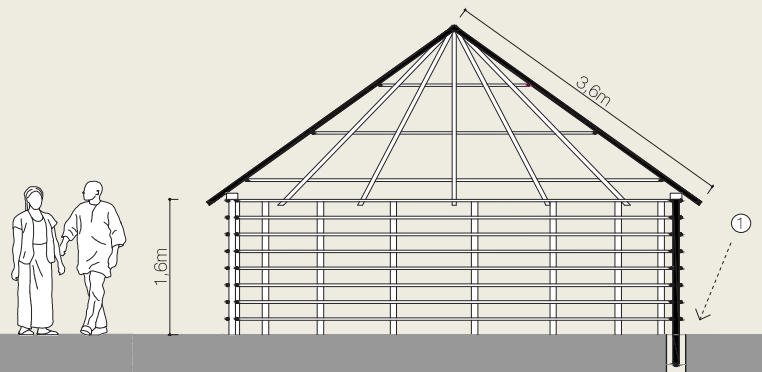

① termite treatment recommended in certain regions

MODEL I

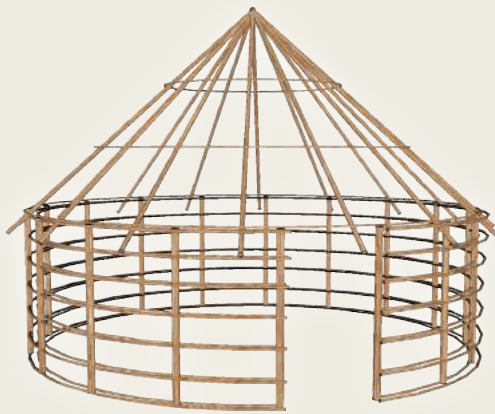

The first model of the Emergency Shelter consists of a circular wooden structure with a conical roof composed by branches of local wooden poles. The wall can be covered by UNHCR tarpaulin, either 5 plastic sheets or 15m length of roll*. The roof is covered by thatch. The shelter has a covered living area of 21,6 m2 and a minimum height of 1,6m.

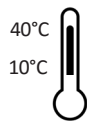

BILL OF QUANTITIES

Item	Specifications	Unit	Qty	Unit Cost US\$	Total US\$
Local Poles	1,2 m length, Ø 8-15 cm	pieces	17	2	34
Local Poles	3,6 m length, Ø 6-8 cm	pieces	16	1	16
Bamboo sticks	3 m length, Ø 2-3 cm	bundle	6	2	12
Synthetic Rope	30 m length, Ø 0,8 cm	roll	1	12	12
Thatch roofing	2 m length	bundle	6	5	30
Nails	75 mm	kg	3	1,5	3
UNHCR plastic sheeting	4 m x 5 m	pieces	5	12	60
Local door	bamboo sticks brading, 0,9 x 1,6 m	pieces	1	5	5

Sub total	172 \$
Transport cost 15 %	26 \$
Labour cost 30 %	52 \$
Total estimated cost *	250 \$

* these costs are based on a 2012 market survey in South Sudan

MODEL II

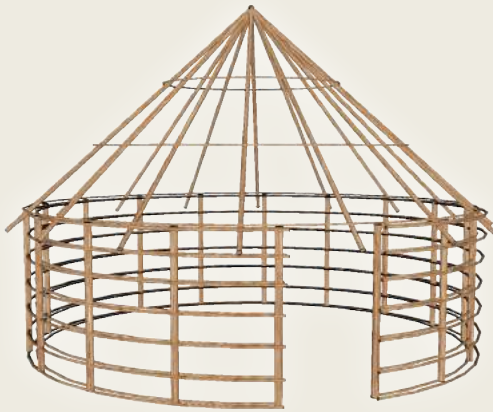

The second model of the Emergency Shelter consists of the same circular wooden structure with the conical roof composed by branches of local wooden poles. The wall in this unit is based on the adobe plastering technology with the wooden structure as plaster support. The roof is covered by thatch. The shelter has a covered living area of 21,6 m² and a minimum height of 1,6m.

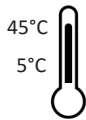

BILL OF QUANTITIES

Item	Specifications	Unit	Qty	Unit Cost US\$	Total US\$
Local Poles	1,2 m length, Ø 8-15 cm	pieces	17	2	34
Local Poles	3,6 m length, Ø 6-8 cm	pieces	16	1	16
Bamboo sticks	3 m length, Ø 2-3 cm	bundle	6	2	12
Synthetic Rope	30 m length, Ø 0,8 cm	roll	1	12	12
Thatch roofing	2 m length	bundle	6	5	30
Nails	75 mm	kg	3	1,5	3
Mud	Excavation / Sourcing	m ³	5	(labour cost)	20
Thatch cladding	2 m length	bundle	6	2	12
Local door	bamboo sticks brading, 0,9 x 1,6 m	pieces	1	5	5

Sub total	144 \$
Transport cost 15 %	22 \$
Labour cost 30 %	43 \$
Total estimated cost *	209 \$

* these costs are based on a 2012 market survey in South Sudan

3.5 TENT SHELTER

UPGRADABLE EMERGENCY SHELTER



SHELTER DESCRIPTION

This emergency shelter was designed in response to fast-onset emergencies in countries with potentially severe climatic conditions, and was implemented in Northern Afghanistan.

It is composed of a pre-cut and drilled bamboo frame structure covered with plastic sheets cladding built around existing tents.

The core living area is provided by a standard UNHCR emergency tent which is enclosed by an outer structure.

The additional covered area beyond the tent allows for the undertaking of typical household activities within a weather protected enclosure.

The bolt together system means the frame maybe disassembled, transported and re-used in the event of further population movement.

LOCATION: Sozma Qala, Afghanistan

PROJECT DATE: October 2009

SHELTER SIZE: 38,7 m2

TIME TO BUILD: 4 hours

LIFESPAN: 2 years

CONSTRUCTION TEAM: 1 skilled + 3 labours

COST PER SHELTER: 813 \$, not including the inner UNHCR tent



DESIGN OPTIONS

The Shelter Tent may be easily upgraded to 'Transitional Specifications' with a variety of materials such as timber for the structure, mud brick for wall covering and iron sheets for the roof.

Additional reinforcement to the structure will be required in this case.

The height of the shelter should also be reduced for decreased wind exposure.



TECHNICAL DRAWINGS

FLOOR PLAN

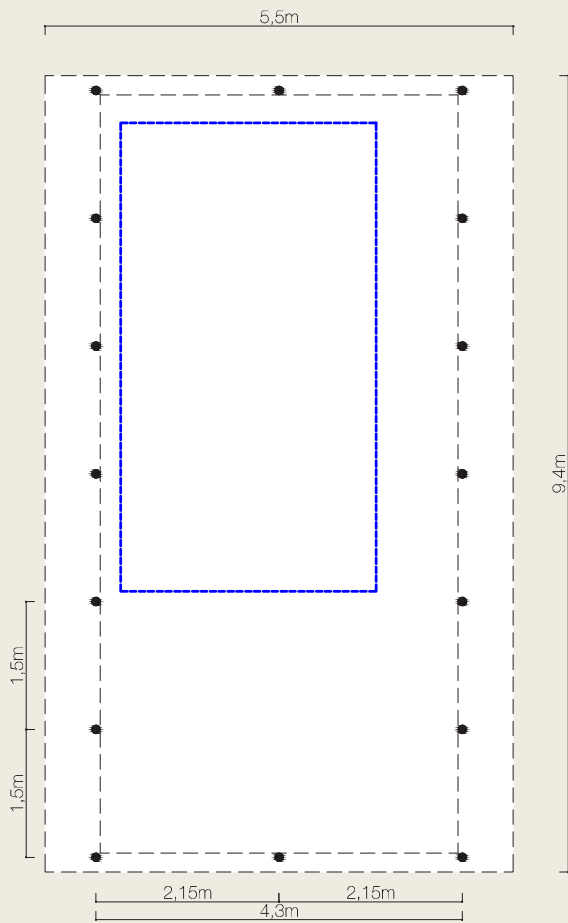

ROOF PLAN

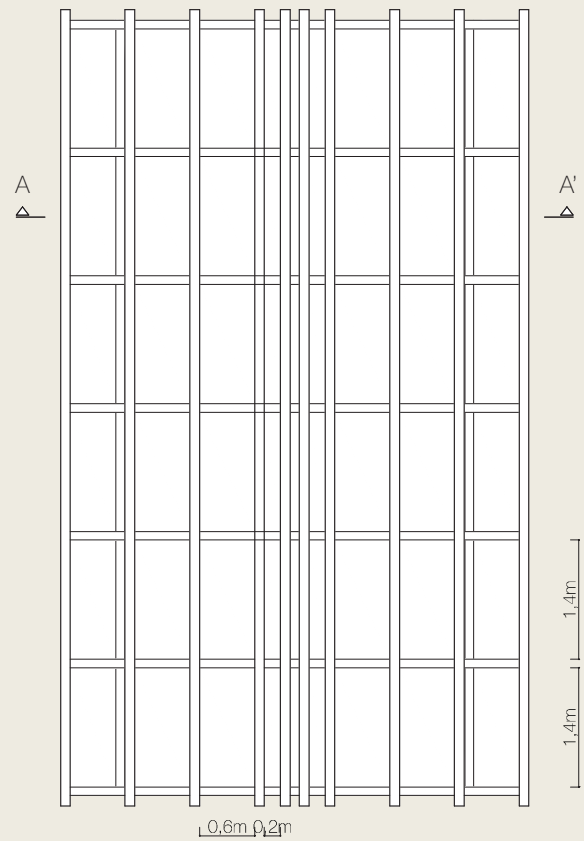

FRONT ELEVATION

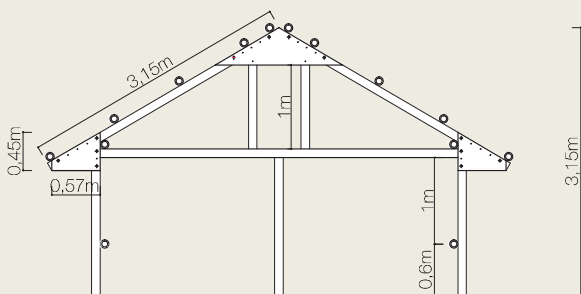

SECTION A-A'

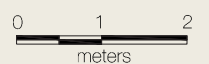
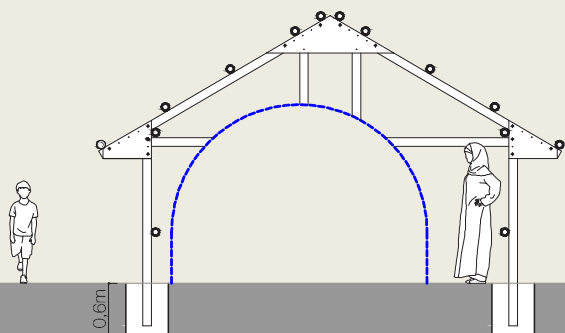

MODEL



The Emergency Shelter Tent is composed by a rectangular bamboo structure, each covering one tent. The frames are connected with plywood gusset plates and bolts. Both the walls and roof are covered by UNHCR tarpaulin, either five 4x5m sheets or 21m length of roll*. The shelter has a covered living area of 39,7 m² (9x4,2 m), and has 1,8 m tall side walls and a gable roof.

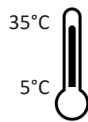

BILL OF QUANTITIES

Item	Specifications	Unit	Qty	Unit Cost US\$	Total US\$
Bamboo	10 m length	pieces	24	15	360
Plywood	6 mm x 1525 mm x 1525 mm	pieces	5	12	60
Bolts + Nuts	150 mm length, Ø 6 mm	pieces	84	0.30	25,2
Washers	(respective to the bolts)	pieces	168	0.02	3,4
Nails	100 mm length	pieces	110	0.02	2,2
UNHCR plastic sheeting	4 m x 5 m	pieces	7	12	84
Nails	75 mm	kg	4	1,5	6
Washers	(for small nails to reduce shearing)	pieces	800	0.01	8
Cotton rope	Ø 6 mm	m	60	0.2	12

Sub total	560,8 \$
Transport cost 15 %	84 \$
Labour cost 30 %	168,2 \$
Total estimated cost *	813 \$

* Tarpaulin roll - 4 x 50 m, US\$ 100

** these costs are based on a 2012 market survey in Afghanistan



4. TRANSITIONAL SHELTER DESIGNS

4.1 AZRAQ T-SHELTER



SHELTER DESCRIPTION

The Transitional Shelter (T-Shelter) was designed for Azraq Camp to host Syrian refugees in Jordan taking into consideration the climatic, financial, and cultural constraints.

Azraq camp was constructed with 13,500 T-Shelter units to accommodate 67,000 refugees in response to protracted displacement. T-Shelters are interlocking steel structures, designed to maximise privacy and protect against severe weather conditions. The T-Shelters provide protection against the strong winds, dust, and extreme changes in climate.

LOCATION: Jordan, Azraq Camp

PROJECT DATE: April 2014

SHELTER SIZE: 24 m²

TIME TO BUILD: 12-16 hours

LIFESPAN: 2-4 years

CONSTRUCTION TEAM: 4 people



DESIGN FEATURES

The T-Shelter design is flexible and simple to produce using local materials.

GABLE ROOF

Better ventilation than a flat roof

KIT FORMAT

The shelter is easy to transport, store, and extend or modify.

LEG EXTENDERS

Facilitate the erection of shelters on slopes or uneven land.

SPACIOUS LIVING AREA

PORCH

Some of the first shelters included a side entrance to increase privacy. This was in direct response to feedback from beneficiaries, who appreciated the modified design.



TECHNICAL DRAWINGS

FLOOR PLAN

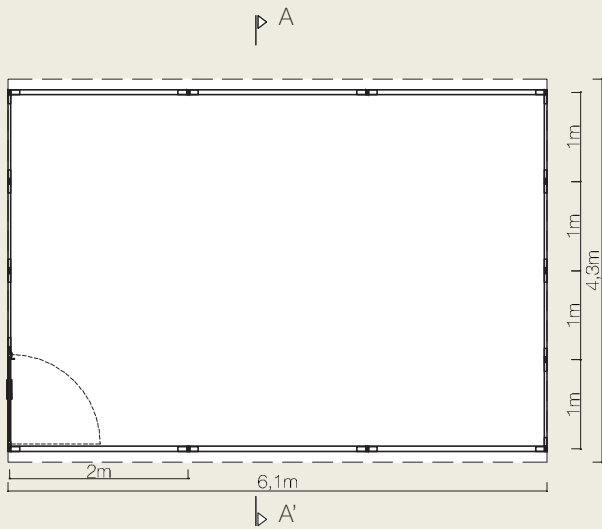

FRONT ELEVATION

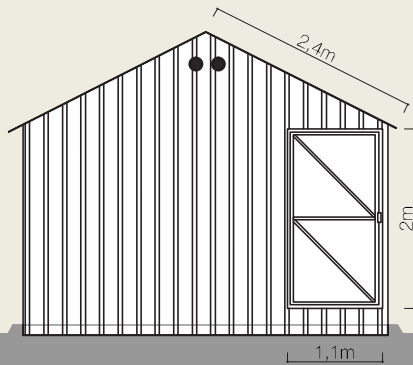

SECTION A-A'

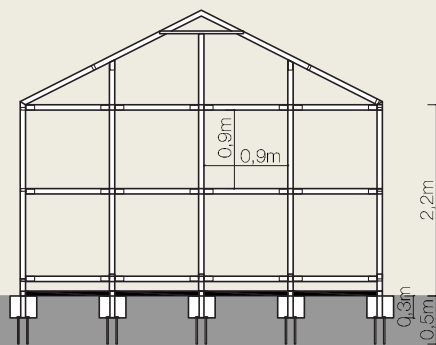

SIDE ELEVATION

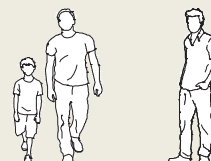
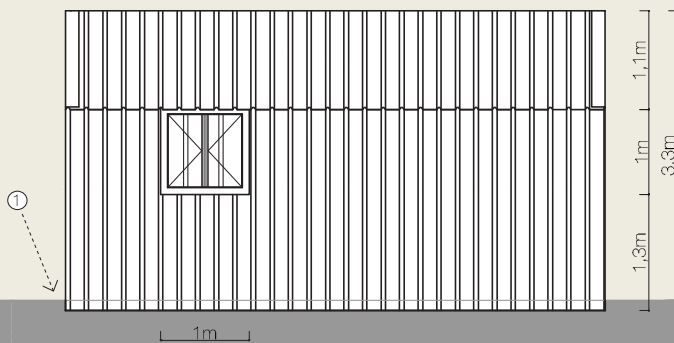

① cladding to up to 15 cm below natural ground level on sloping ground

MODEL

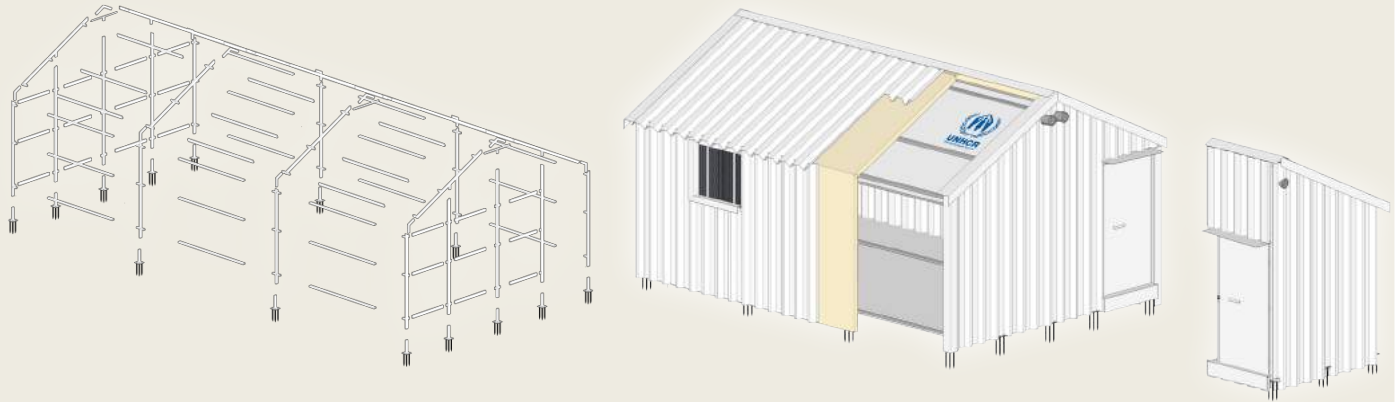

The T-Shelter is an interlocking steel structure covered with a double layer of IBR (Inverted Box Rib) cladding with aluminum foam insulation in between and made to withstand the harsh desert climate of the camp location. The steel elements, cladding, insulation, and other accessories are transported to the site in the form of a kit, which makes it easy to transport and install. The reinforced concrete flooring is later poured on site after the structure is in place. with the possibility of adding a side entrance for enhanced privacy.

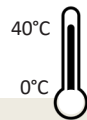

BILL OF QUANTITIES

	Description of work & Items	Unit	Qty	Unit Cost US\$	Total US\$
1	Shelter Steel Structures composed of interlocking structural steel tube elements size 6 cm x 3 cm x 1.2 mm				
1,1	Column and horizontal wall structures Tube 6 cm x 3 cm x 1.2 mm				
a	L=2.2 m	pcs	4	5	20
b	L=2.68 m	pcs	4	5,1	20,4
c	L=3 m	pcs	2	5,2	10,4
d	L=0.95 m	pcs	23	2	46
e	L=2.0 m	pcs	18	3	54
1,2	Rafter steel Tube 6 cm x 3 cm x 1.2 mm				
a	L= 2.3 m	pcs	8	5	40
1,3	Purlin steel Tube 6 cm x 3 cm x 1.2 mm				
a	L=1.97 m	pcs	18	3,5	63
1,4	Rafter Tie Beam (50mmx2mm)				
a	L=1 m	pcs	8	2	16
2	Steel interlockers for steel tubes; profile 5 cm x 2.5 m x 1.5 mm				
a	L=10 cm	pcs	120	1	120
3	Eave interlocker assemble	pcs	8	3	24
4	Gable interlocker assemble	pcs	4	4	16
5	Steel footing shoes				
a	Foundation base Plate (15cm x 15cm x 6mm) including (4 # of 17 mm diameter holes) for steel peg anchorage, welded to steel tube shoe leg of 50 mm x 25 mm x 1.5mm x 30 cm length for leveling of shelter structure	pcs	14	14	196
b	Deformed steel Anchor Pegs with cap on top (30cm long and 16mm dia) / 2 pcs per foundation plate	pcs	28	2	56
6	Steel Angle 3 cm x 3 cm x 2 mm				
a	Supporting steel Angle 3 cm x 2 cm x 2 mm L= 0.95 m	pcs	4	3,0	12

	Description of work & Items	Unit	Qty	Unit Cost US\$	Total US\$
b	Length= 5 cm	pcs	2	1	2
7	Steel door (size: 2mx1.07m) including frame and cross member brace (tube profile 30 mm x 30 mm x 1.2 mm) . Door clad with flat (0.8mm thick) corrugated iron sheeting and filled with Expanded Polyethylene (1.5cm thick) insulation. The door will be fixed with 3 units (14mm thick) steel hinges and fitted with 2 units of steel locks, 2 units door pull handles and 2 units of tower bolts	pcs	1	35	35
8	Door lockers and handles				
a	External and internal pull handles (steel manufactured) 4cm x 4cm x 16cm x 2 mm	pcs	2	10	20
b	Angle iron 4 cm x 4 cm with hole of dia 10 mm for fitting with padlock, must be welded to the door frame	pcs	1	6	6
c	Padlock with 4 keys & plastic key label	pcs	1	8	8
d	Door tower bolts fitted to door top and side to inside of door frames	pcs	2	4	8
9	Door flashing (10x10cm, 90 degrees, 1.1 metre length, 0.4 mm thickness)	pcs	2	7	14
10	Steel Window frame (90cm wide, 89 cm high) split into two window wings, fixed with 2 # of (14 mm thick) steel hinges per wing, opening to the inside by 180 degree; painted white	pcs	1	20	20
a	Lockers fixed to window wings and window frames	pcs	2	5	10
b	Window burglar bar (89 cm x 5 cm X 3 mm flat steel iron) welded to the outside window frame	pcs	2	8	16
c	Framed metal wire mosquito screen fixed to window frame with all needed fixing material, size 0.84m x 0.85m positioned between the window wings and the burglar bars	pcs	1	12	12
11	U-shaped Window flashing (Flat metal 200 mm x 1000 mm x 0.40 mm) fixed to inside and outside of window frame	pcs	4	6	24
12	Wall and roof Insulation				
a	Aluminium foam Insulation (Expanded Polyethylene 15 mm thickness) tightly stretched and fixed with self driving screws (aluminium foam outside) to the shelter's outside frame structure	sq.m	70	2,6	182
13	Wall and Roof Cladding				
a	Roof Cladding: IBR sheeting 0.35 mm thick, eggshell white factory sprayed with a minimum of 17 cm roof overhang at eave level	sq.m	31	4	124
b	External Wall Cladding: IBR (Inverted Box Rib) sheeting 0.35 mm thick, eggshell white factory sprayed	sq.m	50	4,1	205
c	Internal Wall Cladding: IBR sheeting, vertically running from gable ridge and wall plate level to 5cm below natural ground floor level, fixed to shelter frame with self driving screws, color: eggshell white, thickness: 0.35mm	sq.m	50	4	200
14	Steel flashing (All flashing is to be thoroughly fixed with self driving screws to wall and roof cladding to resist wind forces)				
a	Gable end Steel flashing (flat), 15 cm x 15 cm x 0.40 mm x 2.5 m length	pcs	4	15	60
b	Ridge flashing (flat), 15 cm x 15 cm x 0.40 mm x 6.105 m length	pcs	1	18	18
c	Wall Corner flashing (flat), 15 cm x 15 cm x 0.40 mm x 2.25 m length	Pcs	4	15	60
d	Eave flashing to close the gap between roof and wall IBR cladding, 8 cm x 8 cm X 6.1 m	pcs	2	18	36
15	Base course work:				
a	Excavation and compaction of <i>in situ</i> soil to be levelled. Excavated surplus soils might be spread equally around the outside of the building, provided such soil deposits do not increase above 10 cm of the natural terrain. Surplus soils above 10 cm must be deposited away from the shelter site	LS	1	28	28
b	Spreading, watering and compaction of base course (5 cm thick after compaction) with 100% level surface finishing	sq.m	24	3,5	84
16	Reinforced concrete flooring (5 cm minimum thickness reinforced with ϕ 6mm rebar, 30 cm spacing) for Finish Floor Levelling				
a	Two way intercrossing 6 mm diameter reinforcement steel bars at a rate of 30 cm spacing; to be installed on levelled compacted basecourse. Reinforcement bars to be raised 2 cm above the basecourse layer	tons	0,04	950	38
b	Supplying, compacting, and levelling of ready mix M20 (20 Mpa) concrete with minimum 5 cm thickness	Sq.m	24,2	11	266,2

	Description of work & Items	Unit	Qty	Unit Cost US\$	Total US\$
17	Ceiling and Partitioning works				
a	Fixing of L-iron steel angle holders 30 mm x 30 mm x 2 mm x 50 mm length screwed to shelter frame as anchor for ceiling wires	pcs	4	6	24
b	Supply and fixing of turnbuckles for ceiling and curtain & wires	pcs	5	4	20
c	Galvanized wires (2.5mm dia) fixed to L-iron steel angles to hold UNHCR plastic sheeting at ridge level in position	(r)m	16	1	16
d	Tight fixing of (UNHCR supplied) plastic sheeting to ridge wires and wall plate level frame with self driving screws and flat iron bracing	(r)m	12	1	12
e	Galvanized wires (2.5 mm dia) fixed to L-iron steel angles for partitioning shelter at wall plate level.	(r)m	18	1	18
f	Galvanized wires for curtain partitioning (2.5 mm dia) fixed to L-iron steel angles and to turnbukles at wall plate level	(r)m	12	1	12
18	Ventilation				
a	Fixing of 6 inch dia PVC ventilation pipes fitted with metal wire mosquito screen and silicon sealed to Gable wall	pcs	4	12	48
19	Self drilling screw : Ind Hex washer head C1022 Hardened, Dia 3mm x 30mm				
		pcs	600	0,04	24
20	External site works				
a	Exacavation of the foundation trenches, and subsequent back filling of trench once shelter footing anchored. Trench must be between 15 cm and 30 cm deep (subject to ground slope)	lump s	1,00	30,00	30

Sub total	2374 \$
Transport cost 15 %	356 \$
Labour cost 30 %	712 \$
Total estimated cost *	3442 \$

* these costs are based on a 2013 market survey in Jordan

4.2 COMPACT BAMBOO SHELTER



SHELTER DESCRIPTION

This transitional shelter model has eucalyptus post-and-beam structure compact split bamboo wall cladding widely available in Ethiopia, and corrugated iron sheet roof (chosen for its durability).

The shelter has an internal partition, two lockable windows, and a door that could be locked both from the inside and the outside for improved security.

The structure is well ventilated in the hot climate and provides adequate protection from the rain.

The project has benefited not only the refugees but also a large number of incentive and host community labourers, through their enrolment in the construction, training and prefabrication of the shelters. This equally provided them with livelihood opportunities through employment provided by the project.

LOCATION: Ethiopia, Dollo Ado camp

PROJECT DATE: December 2013

SHELTER SIZE: 21m²

TIME TO BUILD: 1 day

LIFESPAN: 2-4 years

CONSTRUCTION TEAM: 3 people



DESIGN OPTIONS

For the cases that the cladding does not prove to be effective in providing the required visual privacy and protection against rain or dust, refugees are using plastic sheeting or pieces of cloth to cover the walls.

WALL COVER MATERIAL OPTIONS

Bamboo mats cladding shelter

Weaving pieces of bamboo as a walling option improving the waterproofing and dustproofing. Mats, binding rope, sewing needles and pliers required for the execution of this option.



TECHNICAL DRAWINGS

FLOOR PLAN

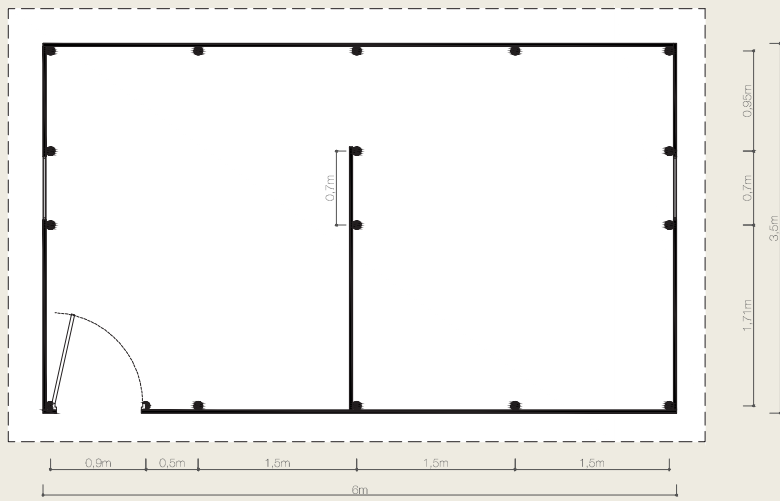

FRONT ELEVATION & SIDE ELEVATION

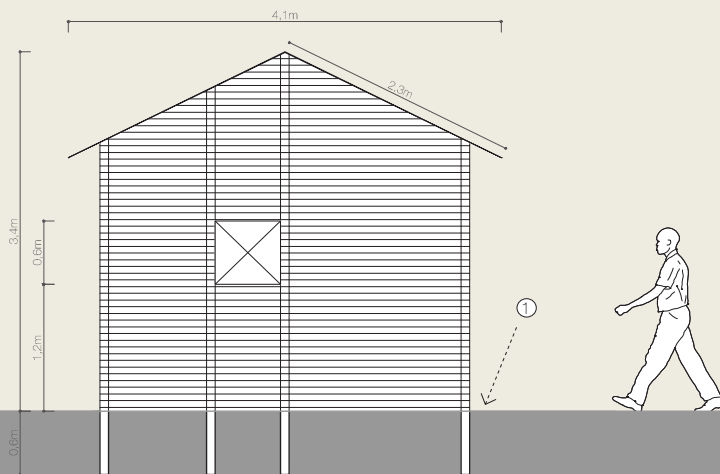
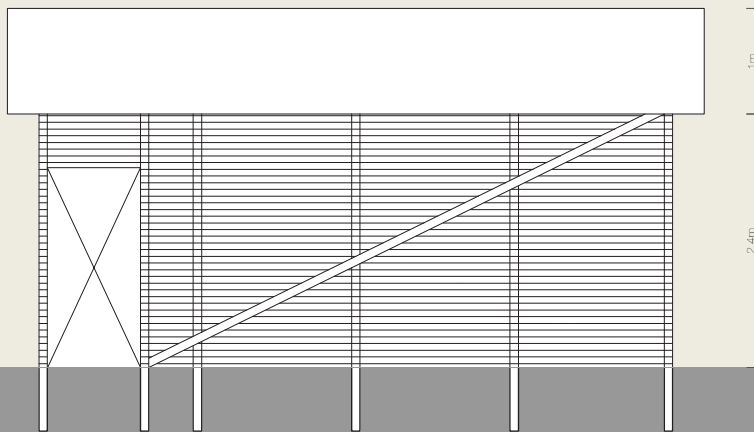

① termite treatment recommended in certain regions

MODEL



The design adopted consists of a wooden structure along with a bamboo wattle support structure. The columns, bracings and roof structure are wooden (Eucalyptus), with treated poles, for improved life span of the shelter. Walling is composed of bamboo slices as a plaster support.

The shelter includes an internal partition, two windows, and a main lockable entrance door for improved security. In addition, the design includes a roof constructed of corrugated iron sheeting.

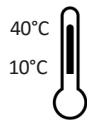

BILL OF QUANTITIES

Item	Specifications	Unit	Qty	Unit Cost US\$	Total US\$
Eucalyptus poles	Ø 8 cm, straight + dry	pieces	35	3,5	122,5
Bamboo	Ø 6 - 7 cm	pieces	92	2	184
Engine Oil	Treatment of poles	liters	3	0,5	1,5
Corrugated Iron Sheets	2 x 0,9 m	pieces	24	5,8	148
Nails	9 cm (for structure)	kg	2,5	1,5	3,75
Nails	8 cm (for structure)	kg	2,5	1,5	3,75
Nails	6 cm (doors and windows)	kg	1,5	1,5	2,25
Nails	CGI Roofing nails	kg	3	3	9
Nails	4 cm (Bamboo)	kg	4	1,5	6
Metal straps	2 cm wide	LM	10	0,2	2
Hinges	T Hinges	pieces	6	0,5	3
Lock system	Small size for windows	pieces	2	0,5	1
Lock system	Large size for doors	pieces	2	0,6	1,2

Sub total	488 \$
Transport cost 15%	73,2 \$
Labour cost 30%	146,4 \$
Total estimated cost **	708 \$

* these costs are based on a 2012 market survey in Ethiopia

4.3 TWIN ELEVATED SHELTER



SHELTER DESCRIPTION

This shelter project in Kachin state, Myanmar, provided transitional shelter to IDPs until a durable solution could be reached.

Resurgence of conflict in late 2012 triggered displacement of several thousand additional IDPs. Most IDPs reluctant to return to their homes due to continuous tensions, lack of livelihood opportunities & possible landmines in their places of origin.

Over 96,000 IDPs dispersed over 150 IDP camps or camp-like settings.

The elevated shelter dimensions are 6,7m by 5,5m, providing two family units of around 18m² per unit.

The shelter has a timber frame structure, bamboo mat walling and flooring (with timber support) and corrugated galvanised iron (CGI) roofing.

Materials used are locally produced and climate appropriate.

The construction technique used is based on traditional methods, making it easier for beneficiaries to maintain and repair. Livelihood opportunities more created, as populations engaged in making the bamboo mats for walls and floors and prepared thatching panels.

LOCATION: Kachin, Myanmar

PROJECT DATE: May 2014

SHELTER SIZE: 36 m²

TIME TO BUILD: 2 days

LIFESPAN: 2-4 years

CONSTRUCTION TEAM: 3 people

DESIGN OPTIONS

The same family unit design can be improved with an attached kitchen.

When extending, the shape of the shelter should be kept simple, important in order to reduce damage in strong winds.

And should not be extended too long, ideally an additional space of 2,5 / 2,75m by 3,35m per kitchen.

Avoiding a large roof overhang, additional roofs must be separated from the main roof.



TECHNICAL DRAWINGS

FLOOR PLAN

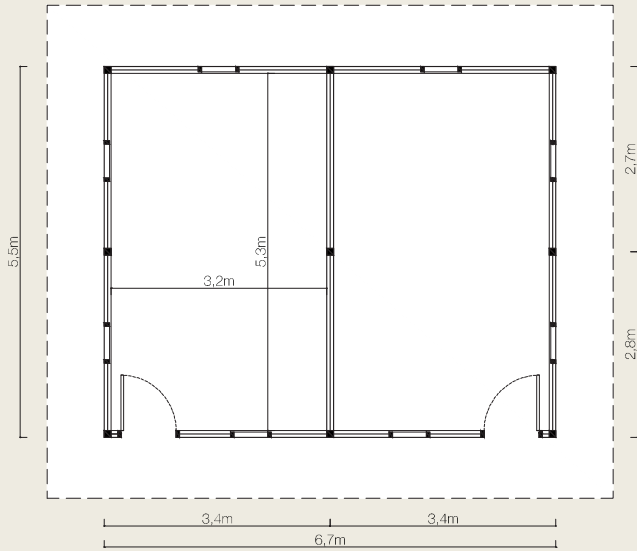

ROOF PLAN

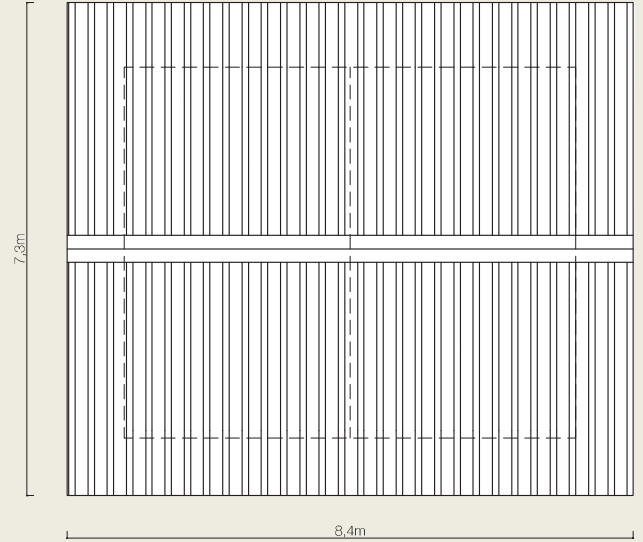

FRONT ELEVATION

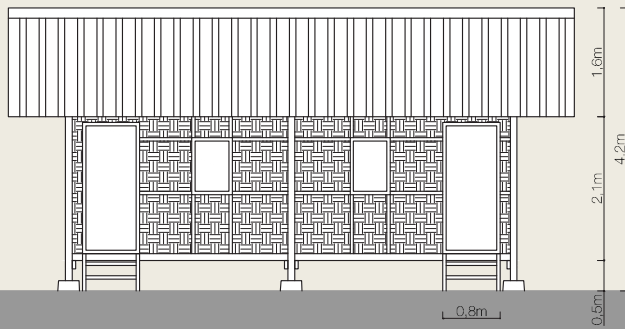

SIDE ELEVATION

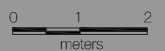
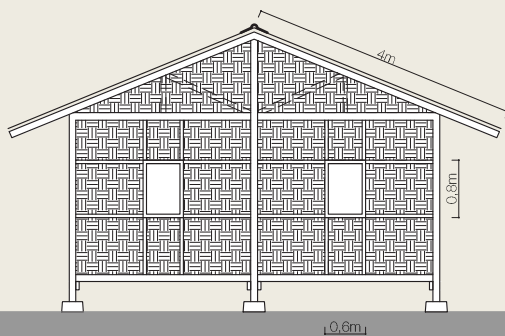

MODEL



The transitional shelter model consists of a timber frame structure with a gable roof. The walls are covered by bamboo mats. The floor is also covered by bamboo mats with timber support. The roof is covered by corrugated iron sheeting. The shelter is reinforced with concrete footing and raised 45cm from natural ground level. The family unit has a covered living area of 18 m² and a minimum height of 3m.

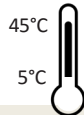

BILL OF QUANTITIES

Item	Specifications	Unit	Qty	Unit Cost US\$	Total US\$
Concrete Post Footing	1'x1'x2'-6'	pieces	9	5,8	67 500
Bolt and Nut	1/2"Ø	set	18	0,10	2 700
Timber Poles	4"x4"	cft	11,38	6	84 175
Timber Poles	4"x2"	cft	26,56	6	196 552
Timber Poles	3"x2"	cft	3,5	6	25 900
Timber Poles	2"x2"	cft	37,73	6	234 827
Timber Poles	3"x1 1/2"	cft	3,73	6	68 296
Timber Poles	3"x1"	cft	2,63	6	19 425
Timber Poles	3"x1/2"	cft	9,23	6	68 296
Bamboo Mat		sft	1 026,3	120	123 156
Wire Nail		viss	7,16	0,10	15 749
Butt Hinge	4"	pieces	18	0,30	6 300
Tower Bolt	5"	pieces	18	0,20	4 500
Door Hadle	5"	pieces	10	0,10	1500
Hasp and Stample	5"	set	2	0,20	500
Bamboo	3"-4"Ø	pieces	29,02	2	72 548
30 Gauge G.I Plaine Sheet	7'-0" x 2' - 10"	sht	49,46	2,5	148 365
Eave and Verge Board	6" x 1"	cft	4,42	6	32 683
30 Gauge G.I Plaine Sheet	8'x3"	sht	1,93	3,5	8 679
Roofing Nail		viss	3,06	2	7 641
Gutter		rft	54,00	1,20	81 000
PVC - downtake pipe	10' x 4"Ø	pieces	1	5	6 500
PVC elbow	4"Ø	pieces	1	3	3 500
PVC 135° bend socket	4"	pieces	2,0	3	7 000
Glue		Can	1	0,40	500
Oil	Termite proof	Gal	5,60	5,50	39 186

Sub total	454 \$
Transport cost 15%	68 \$
Labour cost 30%	136 \$
Total estimated cost **	658 \$

* these costs are based on a 2014 market survey in Myanmar



5. DURABLE SHELTER DESIGNS

5.1 ONE ROOM SHELTER



SHELTER DESCRIPTION

In July 2010 heavy monsoon rains resulted in flash flooding with an unprecedented level of property loss and damage across Pakistan.

As the floods receded, families that wanted to return to their original location were supported through the construction of one room core shelters, aiming to provide the most vulnerable families with safe, durable, cost effective and environmentally sustainable shelters.

The first pilot project was completed in March 2011, providing new housing for 175 families who had been living in tents since August 2010.

Community participation was important for the project. Families provided unskilled labour, including plastering inside the shelter.

LOCATION: Sindh province, Pakistan

PROJECT DATE: Decemeber 2010

SHELTER SIZE: 25 m2

TIME TO BUILD: 5-7 days

LIFESPAN: 10 years

CONSTRUCTION TEAM: 4 people



SHELTER DESIGN

The one-room shelter was designed according to national shelter cluster standards and approved by the government's National Disaster Management Authority in Pakistan.

- . Minimum floor area of 25m2
- . Separate latrine and kitchen
- . Durable foundations
- . Brick/ concrete block construction with cement mortar



TECHNICAL DRAWINGS

FLOOR PLAN

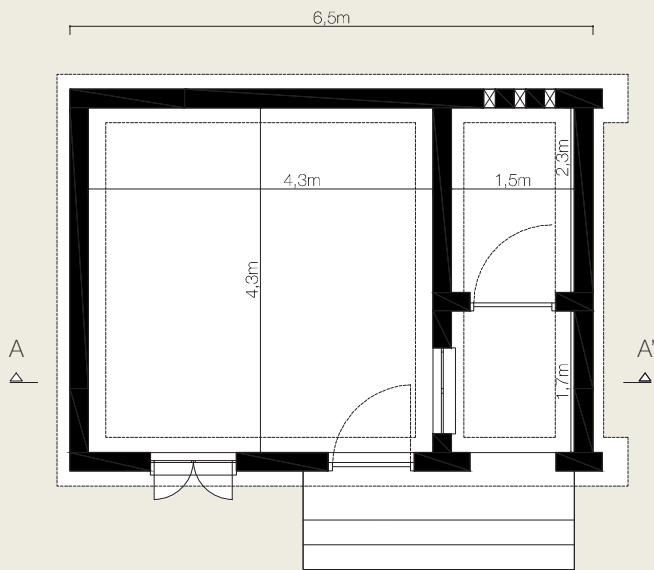

CEILING PLAN

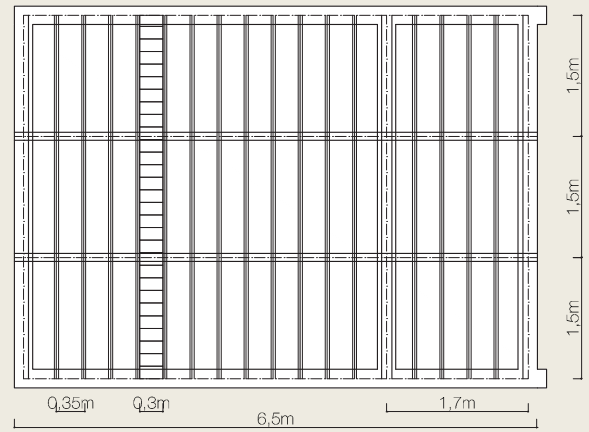

FRONT ELEVATION

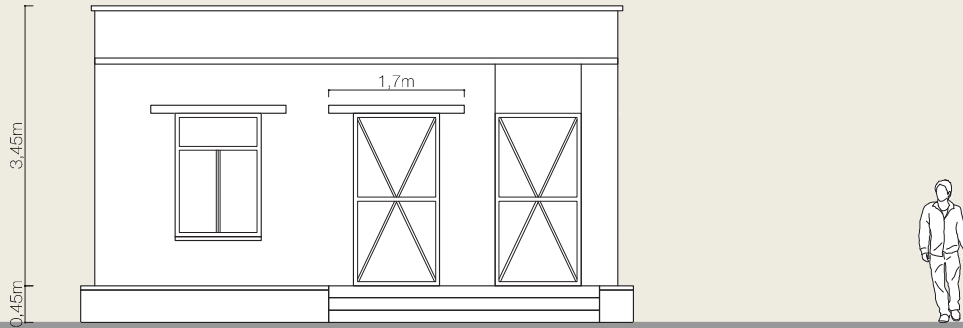

SECTION A-A'

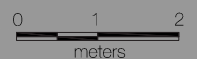
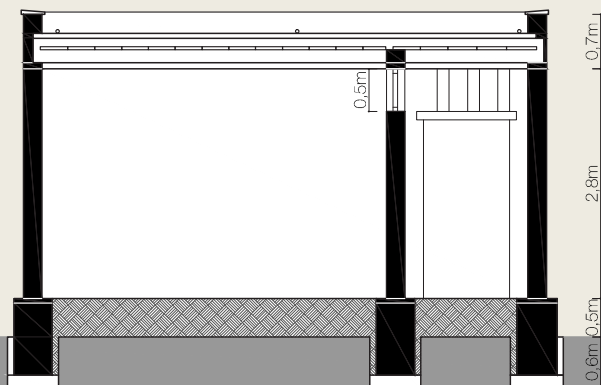

MODEL

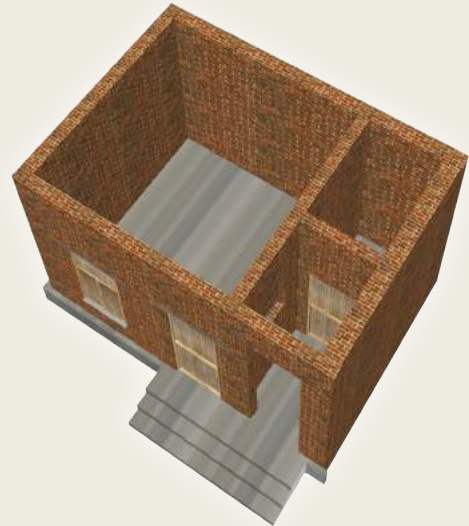

The shelter is a rectangular structure, with approximate dimensions of 4.8m x 3.9m, built of 23 cm thick unreinforced fire burned brick walls and stone durable foundations. The roof is constructed with ceramic tiles supported on steel beams, and a cement plaster coating is placed on top of the tiles.

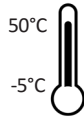

BILL OF QUANTITIES

	Description of work & Items	Unit	Qty	Unit Cost US\$	Total US\$
1	Excavation				
2	Stone work Foundation up to ground level / Random Stone Masonry in 1:6 CMS (Concrete Masonry)				
2.1	Stone	Cft	277	0.1	27.7
2.2	Cement	Bags	10	3.3	33
2.3	Sand	Cft	71	0.1	7.1
3	Stone work from Ground level to plinth level / Random Stone Masonry in 1:6 CMS				
2.1	Stone	Cft	187	0.1	18.7
2.2	Cement	Bags	6,5	3.3	21.45
2.3	Sand	Cft	48	0.1	4.8
4	Plinth Beam 1:2:4 / Damp Proof Course 2" thick with plastic Covering				
4.1	Cement	Bags	2	3.3	6.6
4.2	Sand	Cft	6	0.1	0.6
4.3	Aggregate	Cft	13	0.2	2.6
5	Brick Masonry above Plinth				
5.1	Cement	Bags	3	3.3	9.9
5.2	Sand	Cft	9	0.1	0.9
5.3	Aggregate	Cft	19	0.2	3.8
5.4	Steel	Kg	48	0.6	28.8
6	Brick Masonry				
6.1	Cement	Bags	20	3.3	66
6.2	Sand	Cft	123	0.1	12.3
6.3	Bricks	pieces	7718	0.07	540.26

	Description of work & Items	Unit	Qty	Unit Cost US\$	Total US\$
7	Roof				
7.1	I - Beam, size 4"x 6"x 21.25'	pieces	2		
a	Girders	Kg	62	2.8	173.6
7.2	T - Beam, size 2"x 1"x 14.75'	pieces	1		
a	T Iron	Kg	177	0.5	88.5
7.3	Brick Tiles, size 12"x 6"x 1.5", 504 units	pieces	364	0.1	36.4
7.4	Well-Compacted roof soil, 4" thick (mud)	Cft	97	0.03	
7.5	Good Quality Plastic sheeting	Sft	1	lump sum	12.4
7.6	Straw mixed mud plaster 2" thick (straw mud)	Cft	49	0.03	1.47
7.7	Capping Precast Concrete				
a	Cement	Bags	1	3.3	3.3
b	Sand	Cft	4	0.1	0.4
c	Aggregate	Cft	7	0.2	1.4
8	Steps in 1:4 CMS				
a	Cement	Bags	0,8	3.3	2.64
b	Sand	Cft	4,8	0.1	0.48
9	Floor				
9.1	Filling (mud floor)	Cft	252	0.02	5.04
9.2	Straw Mud Floor	Cft	45	0.02	0.9
10	Door & Windows				
a	Door, timber, 1m x 2m, with frame, hinges and locks	pieces	1	47.6	47.6
b	Window, timber, 0,9m x 1,2 m, with frame, hinges and locks	pieces	2	23.8	47.6

Sub total	1206 \$
Transport cost 15 %	362 \$
Labour cost 30 %	180 \$
Total estimated cost *	1949 \$

* these costs are based on a 2010 market survey in Pakistan

5.2 L SHAPE SHELTER



SHELTER DESCRIPTION

This project was part of a shelter programme for returnees to ensure their re-integration within their areas of origin and communities of return. It had as one of the main objectives the maintenance of minimum living standards for returnees and IDPs, facilitating the establishment and consolidation of conditions for a sustainable return. The new construction of shelters was possible with the participation of several stakeholders including the national government, local authorities and implementing partners, and had a defined maximum cost of 8,500 USD per family. Each shelter is constructed for one family and composed of two rooms, one kitchen and toilet.

- LOCATION: Iraq
- PROJECT DATE: January 2011
- SHELTER SIZE: 40 m²
- TIME TO BUILD: 3 weeks
- LIFESPAN: 10 years
- CONSTRUCTION TEAM: 5 people



DESIGN OPTIONS

Two family-units, each composed of 2 main rooms and 40 m², can be built together. The L Shape core structure can be expanded by the beneficiaries.

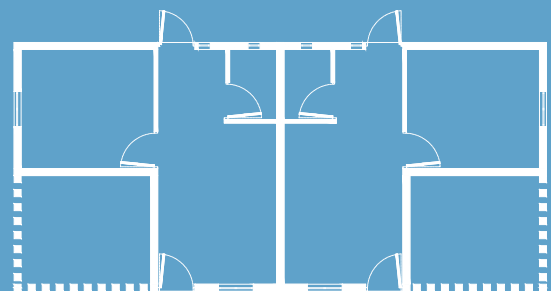

TECHNICAL DRAWINGS

FLOOR PLAN

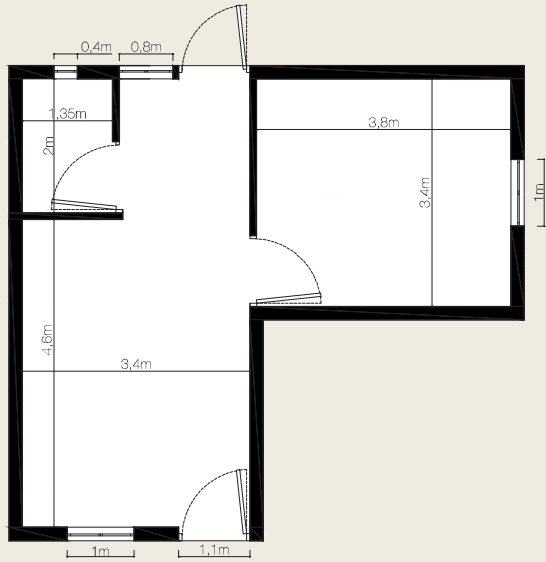

ROOF PLAN

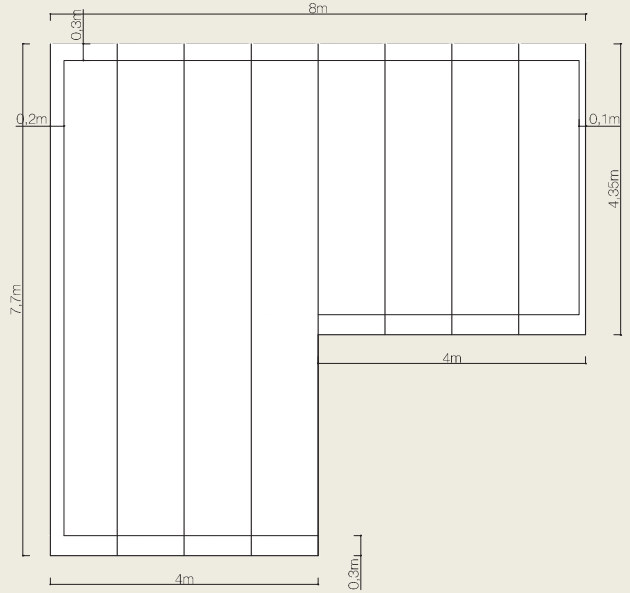

FRONT ELEVATION

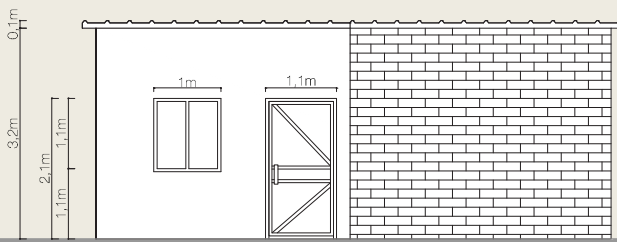

BACK ELEVATION

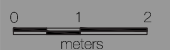
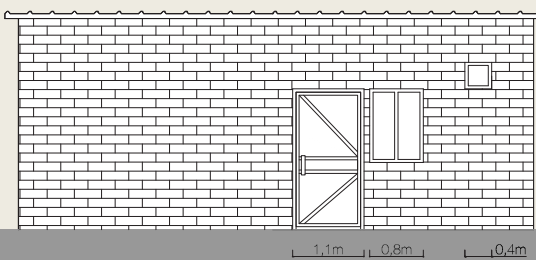

MODEL

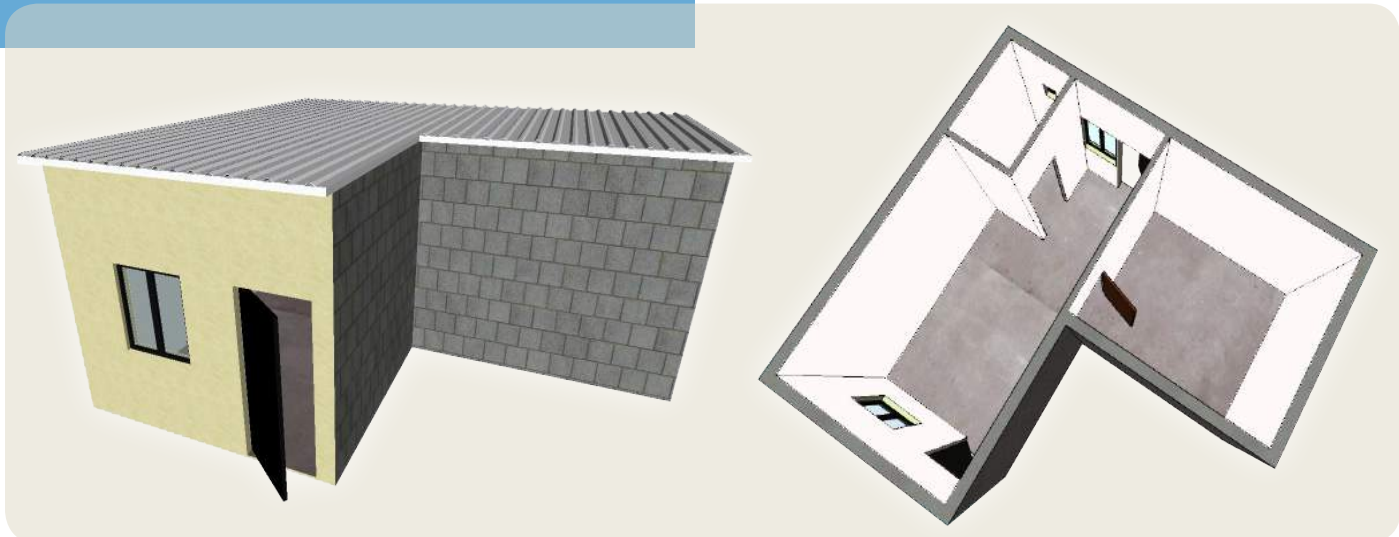

The shelter is a L shape structure, with approximate 40 m2, built on a raft foundation of plain concrete. The external and internal walls are built with concrete hollow blocks of 20x40x40 cm and 10x20x40 cm respectively. Bricks can also be a material option for the walls. The roof is composed of sandwich panels. As designed, the shelter has 2 doors and 4 windows.

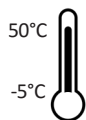

BILL OF QUANTITIES

	Description of work & Items	Unit	Qty	Unit Cost US\$	Total US\$
1	Construction				
1.1	Cleaning site and excavation the septic tank hole 1.4 x 1.4 x 1.5 m deep	m3	2.94	6	17
1.2	Supply materials and cast 20 cm thick foundation using SRC (Sulphate Resisting Portland Cement). The price includes a layer of broken bricks with adequate compaction under the concrete foundation and backfilling	m2	15	20	300
1.3	Cast 10 cm plain concrete for the floors, 1:2:4 mix, using SRC. The price includes a layer of broken bricks with adequate compaction	m2	35	12	420
1.4	Build with concrete hollow blocks 20x20x40 cm the external walls and the septic tank walls.	m2	90	19	1710
1.5	Build with concrete hollow blocks 10x20x40 cm the internal walls (partitions)	m2	6,2	17	105,4
1.6	Plastering the internal walls by using ordinary Portland cement and fine sand (1:3) and then put layer of gypsum material taking into consideration the verticality and alignment according to the technical specifications	m2	72	9	648
1.7	Plastering façade and toilet by using ordinary Portland cement and fine sand (1:3) taking into consideration the verticality and alignment according to the technical specifications	m2	44.5	8	356
1.8	Supply materials and sprinkling the external walls (front facade) with white cement	m2	9.5	3	28.5
1.9	Fill the joints between the concrete hollow blocks for the external walls with Portland cement and fine sand (1:3)	m2	70	2	140
1.10	Supply materials and paint the internal walls, for the toilet and kitchen with three coats of matt white oil paint	m2	34	3	102
1.12	Supply and install Sandwich Panel for the roofs, supported on 3 inch steel channels. Distances between supports should not exceed 1.5m	m2	48	40	1920
1.14	Supply and install steel hinged doors with steel frame. The skeleton should be manufactured by using steel angles, then plated on both sides with steel plate gage 18. All metal surface should be painted (primed) with anti-corrosion paint and finished with suitable oil paint the price includes supplying and fixing of all required locks, hinges,etc	pieces	2	150	300
1.15	Supply materials and install new timber doors complete with the frames (0,9 x 1,80m). The door shall be supplied with good quality hinges, key locks and painted with wood paint	pieces	2	115	230
1.16	Supply and install windows, price includes hardware, all metal surfaces should be painted (primed) with anti-corrosion paint and finished with suitable oil paint price includes submitting glass	m2	3.25	60	195

	Description of work & Items	Unit	Qty	Unit Cost US\$	Total US\$
1.17	Supply and install steel stand for the water steel tank, using steel angle 2.5x2.5 inch 5mm thick with 3 m high the stand will supported in whole of 0.3X0.3 m , 0.5 m depth , casted with concrete (SR cement) and according to the technical specifications. the price includes painting the steel stand with anti corrosion paint	pieces	1	170	170
	Total Construction				6647,9
2	Plumbing & Sanitary				
2.1	Install white new ceramic oriental toilet. The price includes Supply and install 4 inch gully trap, elevated shower with its accessories and supply and installaion of 1/2" tap	pieces	1	50	50
2.2	Supply and fix of best quality stainless steel sink, single basin, one wing, properly fixed on galvanized steel pipe stand. Price including supplying of chromium mixing tap to be connected to water supply system . The sink should be connected to gully trap with best quality rubber hose properly connected to drain	pieces	1	53	53
2.3	Supply and install galvanized steel tank (gauge 18) of one m3 capacity complete with overflow, drain and control valve, inlet and outlet pipes with all necessary fittings	pieces	1	100	100
2.4	Supply, installing new 1/2" galvanized pipes, fittings, connection with water network	ml	14	8	112
2.5	Supply, install 4 inch diam. high pressure PVC pipes for the network sewage and connected with manhole	ml	6	10	60
	Total Plumbing & Sanitary				375
3	Electric installation				
3.1	Install, fix, test and operate single phase surface or flush distribution board with door to be mounted on or in the wall, with main double pole circuit breaker of 40 amp, 2 way CB of ratings as required, the work includes connecting with the main circuit breaker and wires. Cables were included in the price, work must insure safety regulations and standards	pieces	1	20	20
3.2	Supply, install and operate lamp (economic type) with its holder, with wiring & switch.	pieces	5	8	40
3.3	Supply, install, and test socket outlet 13-15 AMP, 250 V, combined with switch, inside a suitable plastic box with the feeder wire 2 x 2.5mm	pieces	3	6	18
3.4	Supply, install and test ceiling fan with regulator, including all connecting wires	pieces	2	25	50
	Total Electric installation				128

Sub total	7145 \$
Transport cost 15 %	10712 \$
Total estimated cost *	8217 \$

* these costs are based on a 2013 market survey in Iraq



UNHCR Family Tent



T-Shelter



Tuareg Tent



Tuareg Shelter



Wooden gable frame Shelter



Refugee Housing Unit



L shape Shelter



Tent Shelter



One room Shelter



Compact bamboo Shelter



Tukul



Twin elevated Shelter

