

DIPLOMA

MATEUSZ PIETRYGA

BOOK NR 2 - PROCESS

SECLUSION AND OPENNESS

laboratory in an urban setting

AHO School of Architecture and Design
Institute of Architecture

diploma project
2021/2022

academic supervisors:

Beate Marie Hølmebakk
Chris-Johan Engh

external consultants:

structural engineering - Tinus Aune
strategic design & urban planning - Mike Fritsch
laboratory typology - Vitor Oliveira
semester guest critic - Christine Petersen

01. INTRODUCTION

- the laboratory
- contrasting spaces
- the public image
- introducing openness
- the role of architecture

02. INVESTIGATION No.1

- control
- operation
- control

03. INVESTIGATION No.2

- openness
- context
- shared knowledge

04. INVESTIGATION No.3

- Mesa Laboratory
- Salk Institute
- S.C.Johnson

05. INVESTIGATION No.4

- intention
- fear
- believe

06. INVESTIGATION No.5

- artificial and natural light
- airflow
- circulation

07. INVESTIGATION No.6

- city context
- strategic decisions
- site
- analysis

08. INVESTIGATION No.7

- concept development
- process
- program
- site
- schedule

08. INVESTIGATION No.8

- technology
- process
- program
- site
- schedule

01. INTRODUCTION

abstract, the laboratory, introducing the openness

preliminary thoughts and intentions

By observing the current pandemic we could learn that certain procedures and actions taken by highly specialized companies and institutes are not entirely clear for the public.

There is an existing problem of public trust. Ever-expanding accessibility to knowledge is in opposition to being so radically locked towards society. The laboratories often behaved like a fortress - focused on high security and silence protocols, protecting the research from external insights. The outcome was an architecture closed behind high fences, obscure and inhuman.

This tendency has changed. Increased awareness among consumers and society has forced companies and institutes to redefine the public image. Transparency of taken actions leads among strategies to succeed on the market. Scientists are more and more present in the public arena. Science seeks a room in our daily life to express itself.

I believe architecture could meet the foregoing expectations.



Fig. 1 : JPL Spacecraft Assembly cleanroom facility, NASA, Pasadena, USA
Fig. 2 : the biopharmaceutical production and research facility, Pfizer

the laboratory

Space for science seems to be a missed architectural opportunity. With all its practical qualities, barely a few buildings represent considerations for the quality of the space.

Amongst others, the technical requirements that those buildings have to meet could be the catalysts for the creation of various spacious extremes. The themes of scale, light, and flow will be investigated as opportunities for architectural settings.

A part of the process will be to challenge current typologies, introduce new qualities whilst keeping their pragmatism.

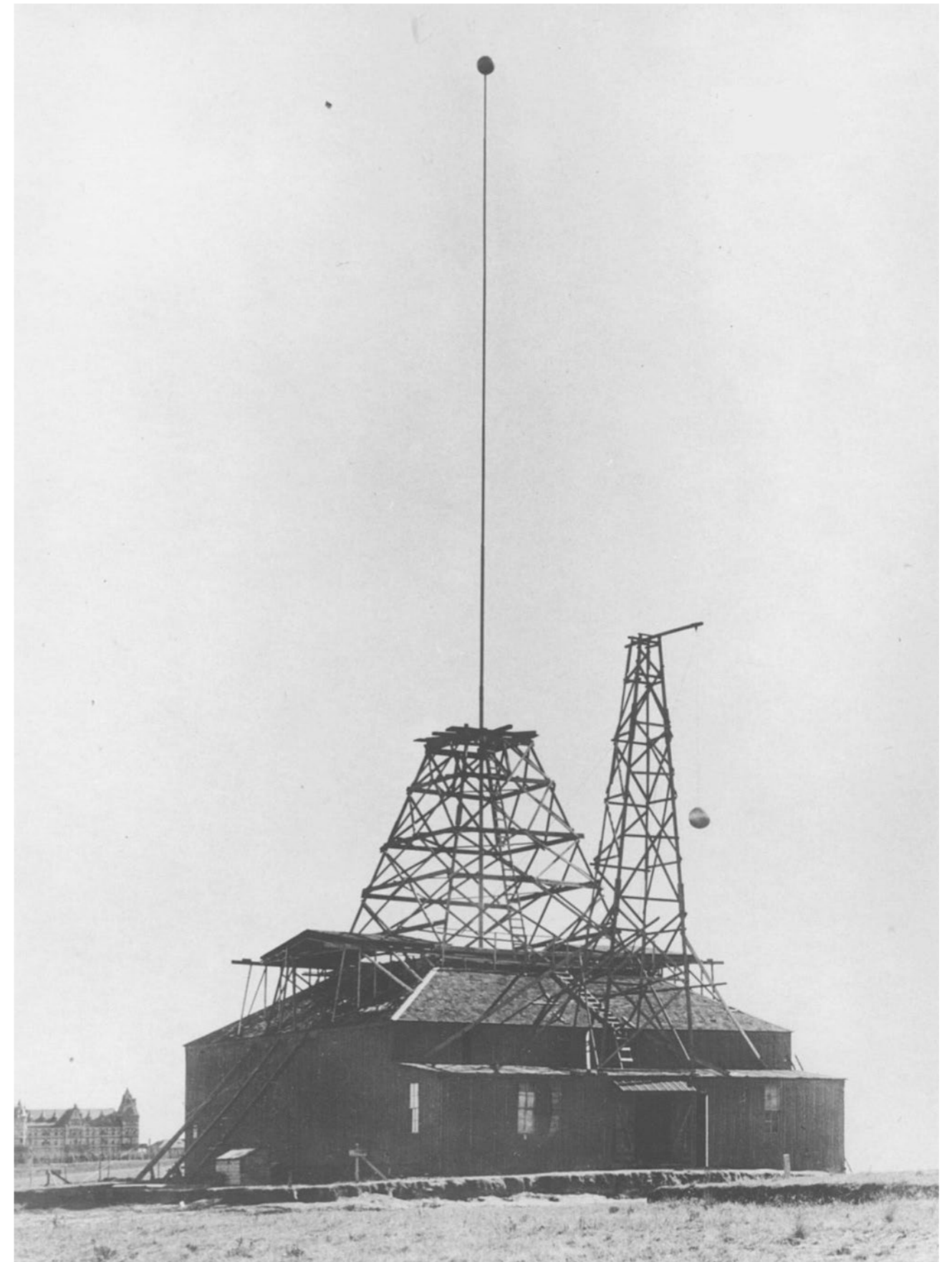


Fig. 3 : The Tesla Experimental Station, Colorado, USA

contrasting spaces

The extremes are to be found in the character of the spaces that come together to create a laboratory. What is on display comes with radically different qualities than the backbone of the building.

The cold white spaces of the laboratory are treating a human as an intruder- instructing him to wear protective clothes, become anonymous, and behave in a controlled manner.

On the other hand, the luxurious lobbies and board meeting rooms are most often unable to tell the story of the research that takes place inside. As a result, the visiting person never really touches upon the essence of what this unique working environment represents.



Fig. 4 : The lobby of the Photographic Science Laboratory, USA, 1943
Fig. 5 : Wayne University's Laboratory ,USA, 1935

the public image

Recently, the news (especially negative) regarding big-pharma companies and laboratory procedures are among the best-selling ones. The massive amount of money that those companies feed the governments with, thus influencing their decisions, can't pass unnoticed by public opinion. The lack of transparency due to the market rivalry also does not help in restoring the trust.

This, and more, have created a negative portrait of those companies. We often tend to forget the contribution many of them made to the development of science and the improvement of our health.

Animals farmed
Animal
experimentation

Animal testing suspended at Spanish lab after 'gratuitous cruelty' footage

Madrid regional government says it has suspended all activity at Vivotecnia after inspection found 'signs of animal mistreatment'

Animals farmed is supported by



About this content

Ashifa Kassam in Madrid and Natalie Grover

Mon 12 Apr 2021 12.20 BST



▲ One of the images released by Cruelty Free International, said to be taken by a whistleblower who worked at the Vivotecnia testing facility in Madrid between 2018 and 2020. Photograph: Cruelty Free International

Pharmaceuticals industry

Pharma firm Advanz fined after thyroid drug price hike of 6,000%

Competition watchdog found company's 'excessive and unfair' prices cost NHS almost £30m extra over 10 years

Jillian Ambrose and Rob Davies

Thu 29 Jul 2021 08.21 BST



▲ The repeated price increases led to NHS spending on the tablets to soar from £600,000 in 2006 to more than £2.3m by 2009 and £30m by 2016. Photograph: Melanie Foster/AAP

The UK's competition watchdog has imposed fines of more than £100m on the pharmaceutical company Advanz and its former private equity owners

introducing openness

Alienation versus openness - and the possibilities behind the juxtaposition of these contrasting space characteristics are in the center of my pre-diploma research. Introduction of the public matter into a scientific building can result in an interesting combination, both socially, politically, and architecturally.

Designing such a space is a big logistic task that will significantly influence the architecture emerging from it. To some extent, it is similar to a proposal for an archive or museum, where operation with two variations of routes - public and restricted, is in use. Diploma work will have to classify the permanent, temporary, transitory rooms with public, semi-private and restricted routes.



the role of architecture

Technological needs, crucial for the proper functioning of this type of building, determine many design decisions. However, it should be remembered that the scientific space is not only a room for machines and devices. The choices made by the scientists working there and their ability to think innovatively are equally important in the research process. This again requires a quality workspace. Inspiring, sparking creativity, and meeting the needs of interaction and cooperation between individuals.

Achieved not only within the building itself but also in the relation between building and city. Along with the changing tendencies in science, it ceases to be an isolated discipline, it comes out against people and needs their attention. Architecture plays a key role here, as it is capable of providing spatial solutions that can help create such an interaction. Increased communication between those two worlds can result in better dialogue and improved business standards.

The less obvious layer is architecture that reflects the scientific ambiance. Architecture that talks about the values of a thorough understanding of the world and affects people in a way, that communicates this idea. That idyllic vision of the role of architecture was important for Luis Kahn in his work on Salt Institute and became an intention in this case as well.



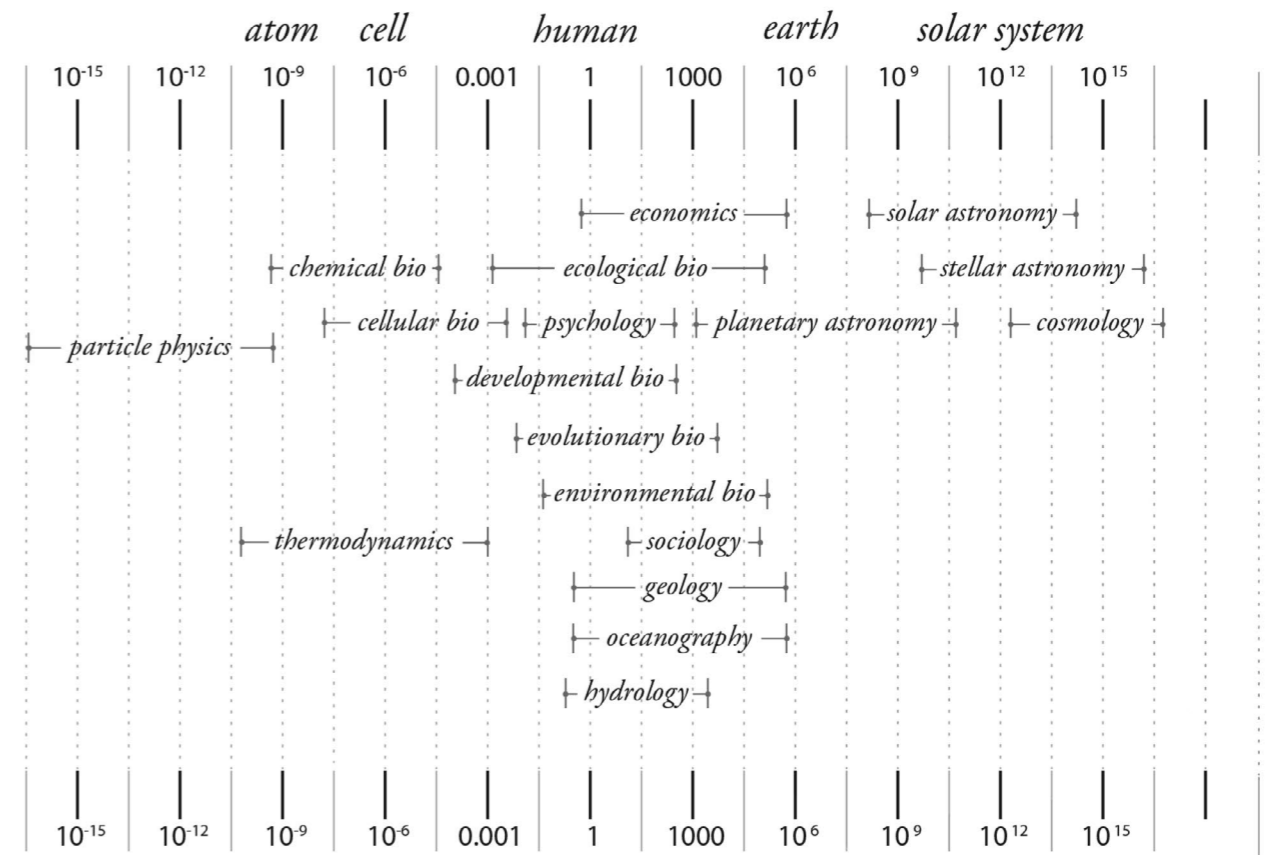
Fig. 10 : Louis Kahn's Salk Institute, 1965, photo by Jason Taellious

02.INVESTIGATION No. 1

scale, operation and control

fields of science & industry state

in need of architecture taking control over indoor environment in
research and/or production facility



Tackling the scientific problems from a human perspective became almost unconstrained in terms of the scale of the observed objects. Over the period of thousand years, we found a way to align them to our limited senses.

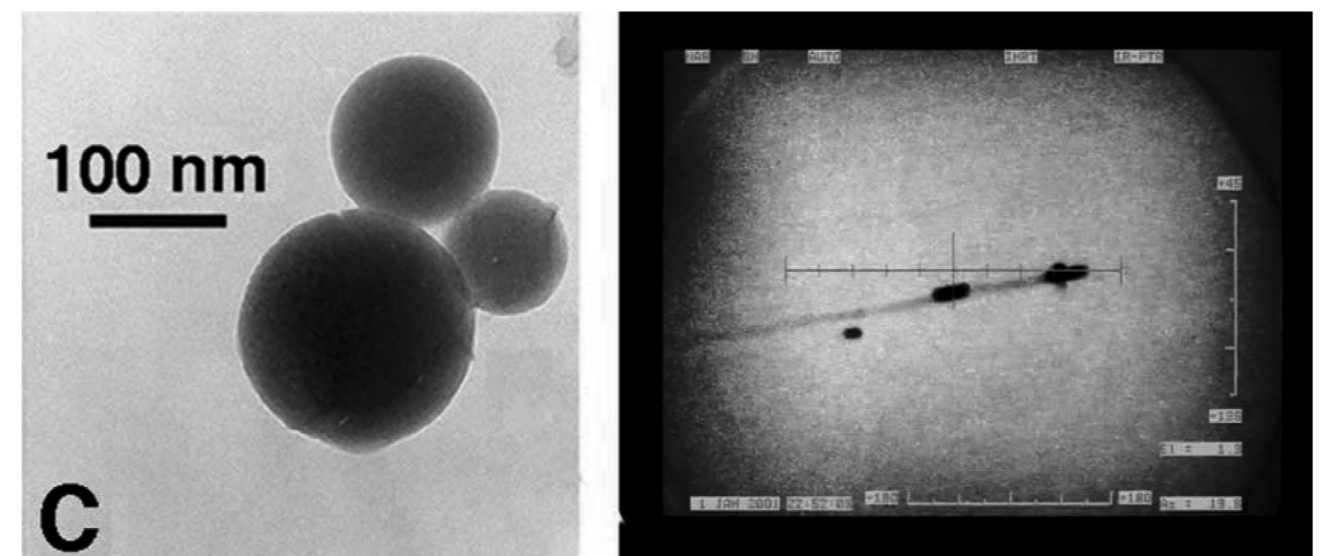
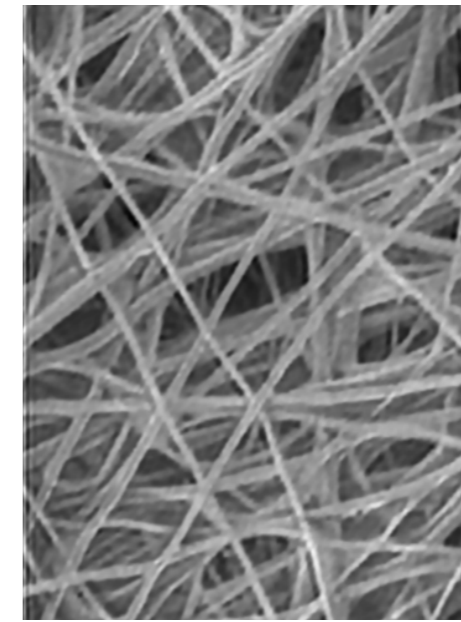
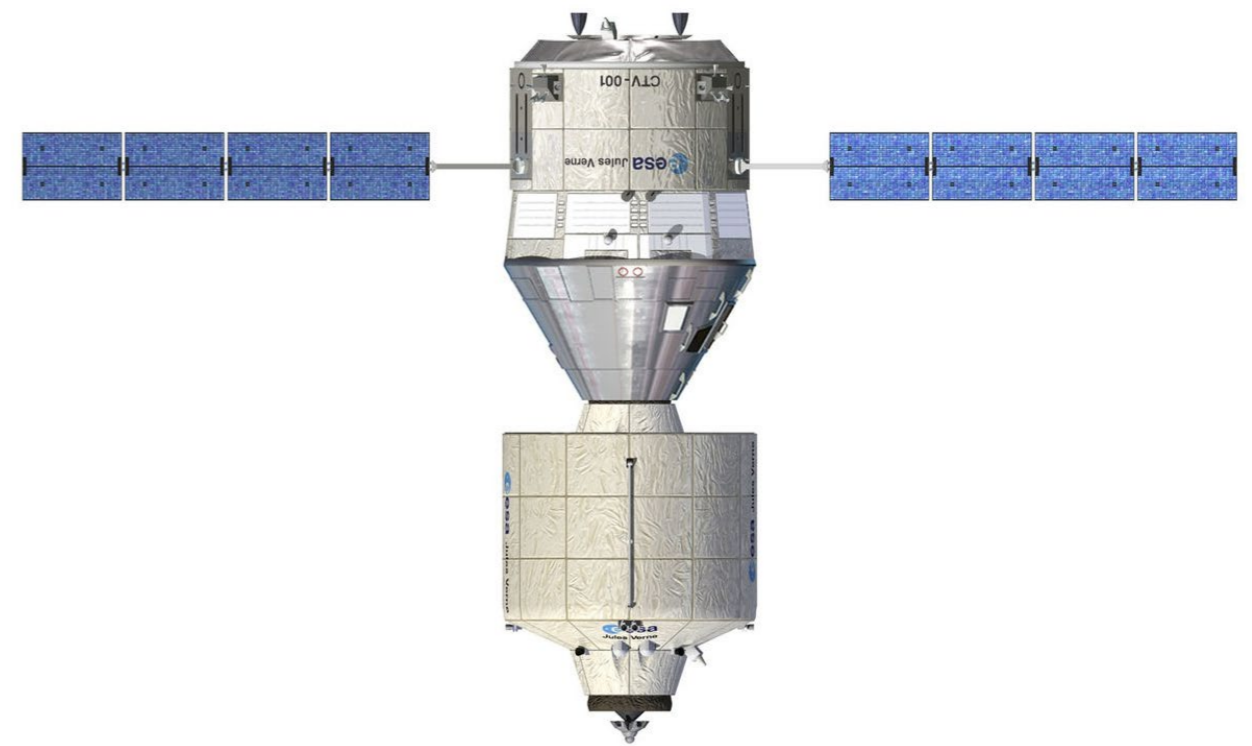


Fig. 11 : diagram illustrating scales of scientific inquiry, Adrian Lahoud, 2015
 Fig. 12 : carbon dioxide molecule, satellite image of human migration, Adrian Lahoud, 2015

Means by which we obtain the anticipated result define the architectural measurments.
The dimensional extremes that one room can reach, in this typology, is an architectural phenomnom.



100000:1



1:100

PRIVATE

automatization, focused on production, specialised, big scale of operation

PUBLIC

flexibility, diversity, spontaneity, experimental character

Cornell Ornithology Laboratory laboratory and animal shelter, 2003 7 400 sq.m.	+ Bispebjerg Hospital Laboratory and Logistic clinical biochemistry, 2018 9 500 sq.m.	+ Mercedes-Benz Factory and Technology Center automotive, 1915 120 000 sq.m. + 27 000 sq.m.
Salk Institute biological research, 1965 38 200 sq.m.	+ Max IV Laboratory X-ray research facility, 2015 49 500 sq.m.	+ Maersk Tower medical research, 2017 42 700 sq.m.
Jet Propulsion Laboratory unit aerospace research, 1936 10 500 sq.m.	+ Novartis Laboratory pharmaceutical research, 2010 11 600 sq.m.	+ Ippin Dental Laboratory dental facility, 2013 100 sq.m.
High-Voltage Test Laboratory electric power research, 1960 1 400 sq.m.	+ Sainsbury Laboratory plant science, 2010 11 000 sq.m.	+ Lab City CentraleSupélec engineering school facility, 2017 48 700 sq.m.

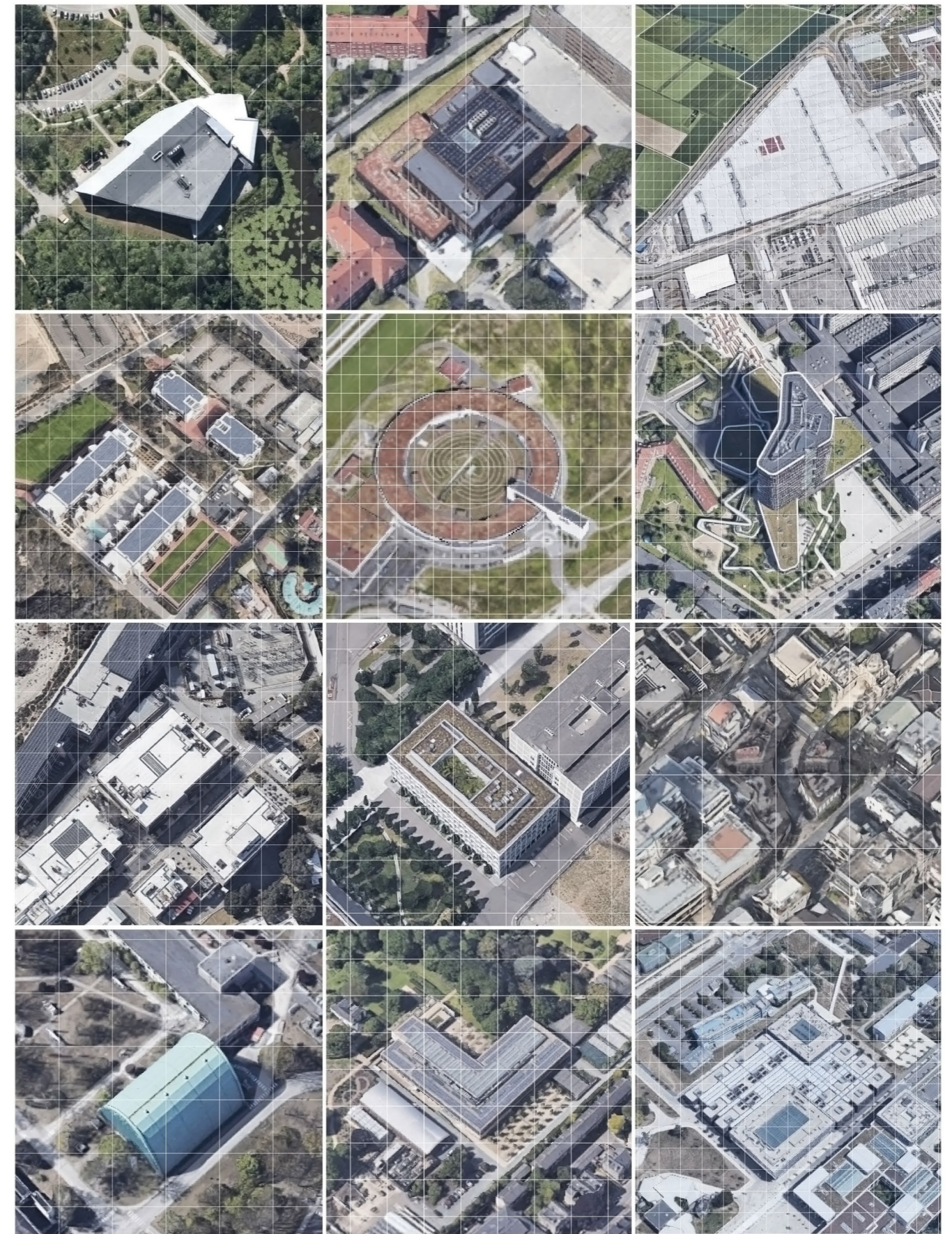


Fig. 15 : collage based on captured aerial photo, scale comparison; author

The relation between the scale of operation and context in which the laboratory is situated - reflecting the infrastructure need, the theme of research, and privacy policy.



Fig. 16 : Ippin Dental Laboratory, Tokyo, Japan

Fig. 17 : High Bay 1 cleanroom, Spacecraft Assembly Facility, NASA, Pasadena, California, USA

Fig. 18 : Frequency quadrupled IR laser, experiment

AEROSPACE SCIENCES

AUTOMOTIVE

BIOTECHNOLOGY

ELECTRONICS

FOOD MANUFACTURING

LIFE SCIENCE RESEARCH & LAB SERVICES

NANOTECHNOLOGY

OPTICS AND PHOTONICS

PHARMACEUTICAL SCIENCES

ROOM CLASS

1, 5-6

7-9

1-4

3-6

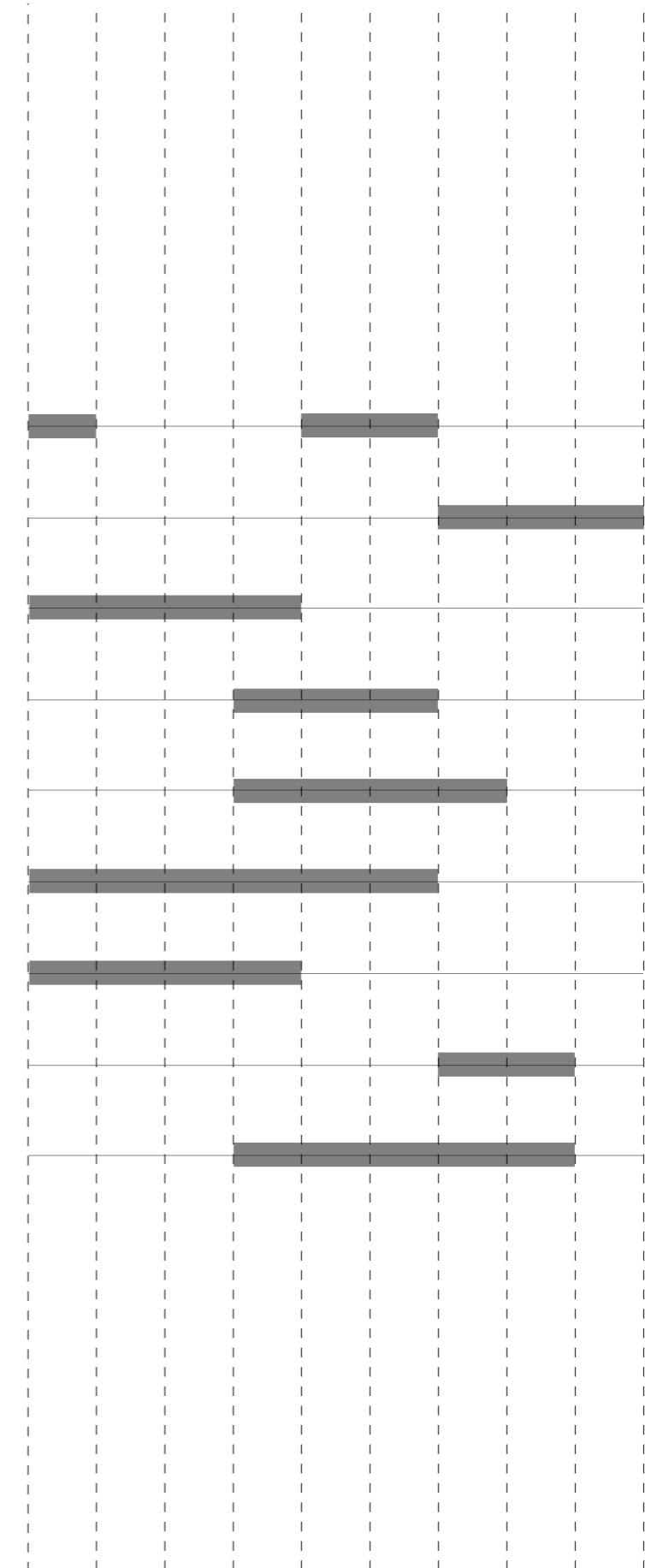
3-7

1-6

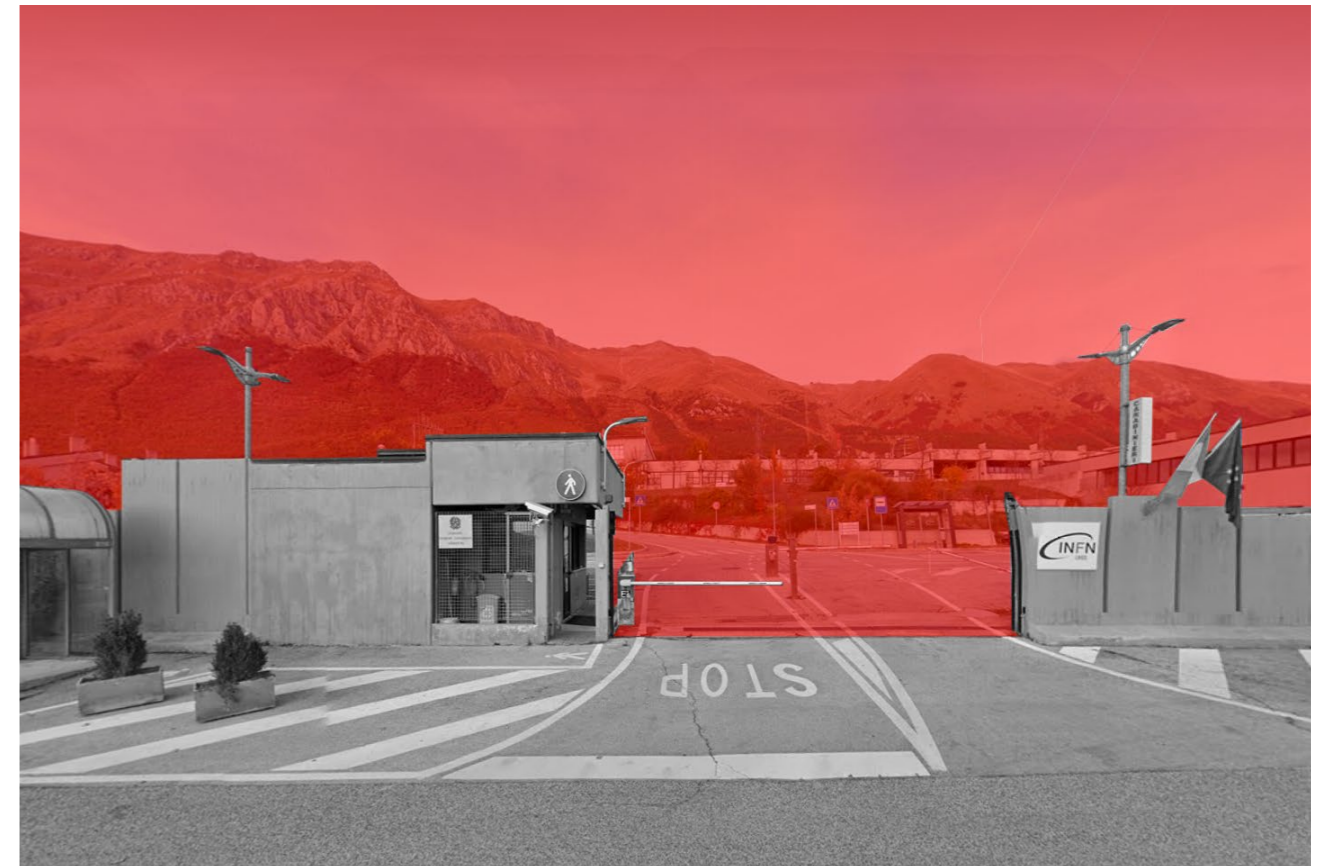
1-4

6-8

4-8



The control over the indoor environment has expand also outside the building, creating a border and inaccessible, monitored territories. This takes place both in the urban setting and in the context of nature.



This tendency sometimes leads to a wipe-out of whole regions within the city. Detached from inhabitants through the border condition such as terrain height difference, steel fences, and security control. Most often becoming the ghost districts.



Fig. 22 : map of the city of Basel, Switzerland with highlighted area of Novartis campus; author

03.INVESTIGATION No. 2

openness, location, shared knowledge

laboratory transformations

tendencies and changes in the typology, past and current

In 1597, initiated by Pieter Pauw the dissection theater in Leiden became open to public. This cabinet of curiosities displaying not only human corpses, but also skeletons of birds and animals, held a regular ceremony of dissection.

With time the ceremony changed into a performance, accompanied by big interest from the public, with a music in the background, perfumes diffused in the air and candles illuminating the room.

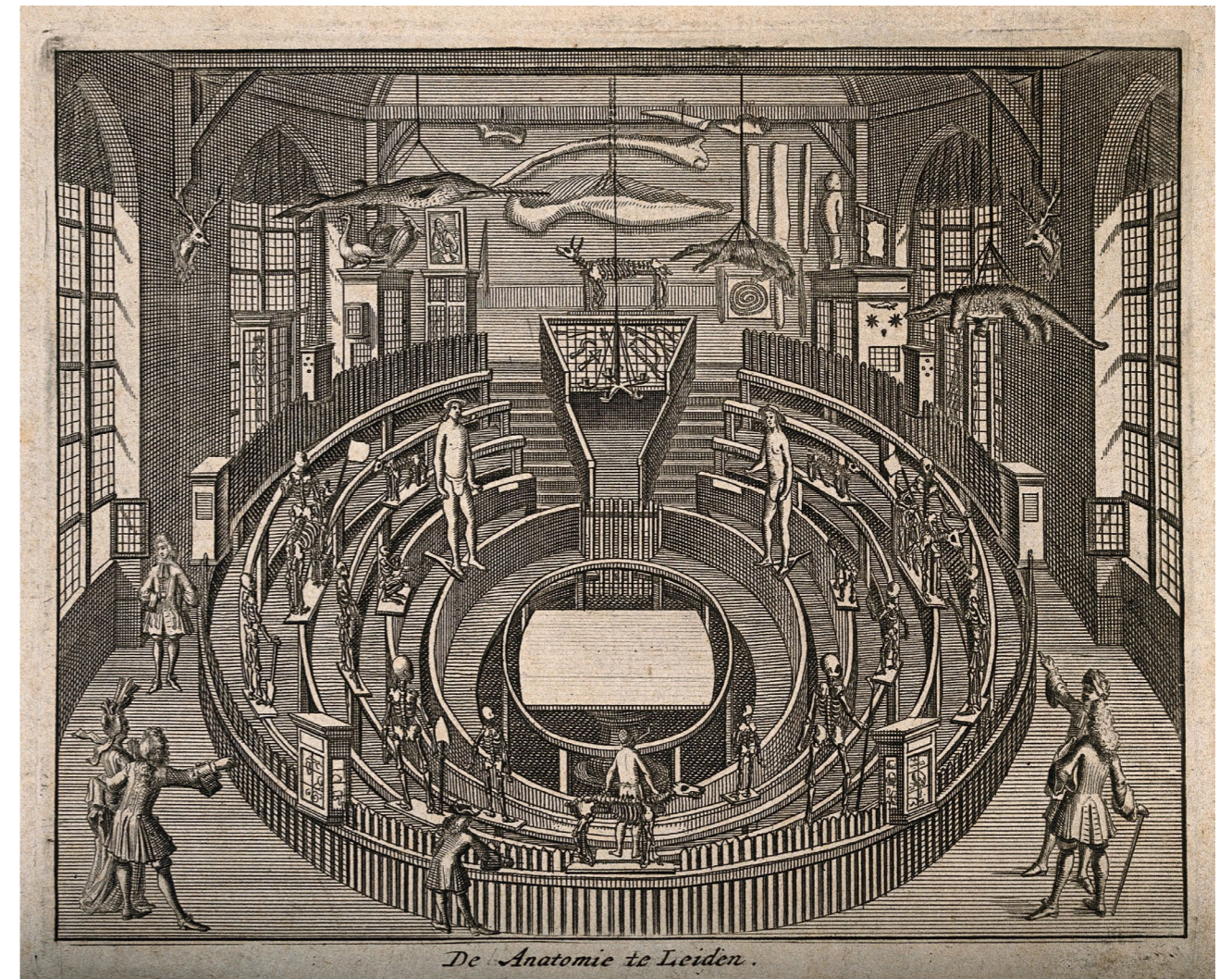
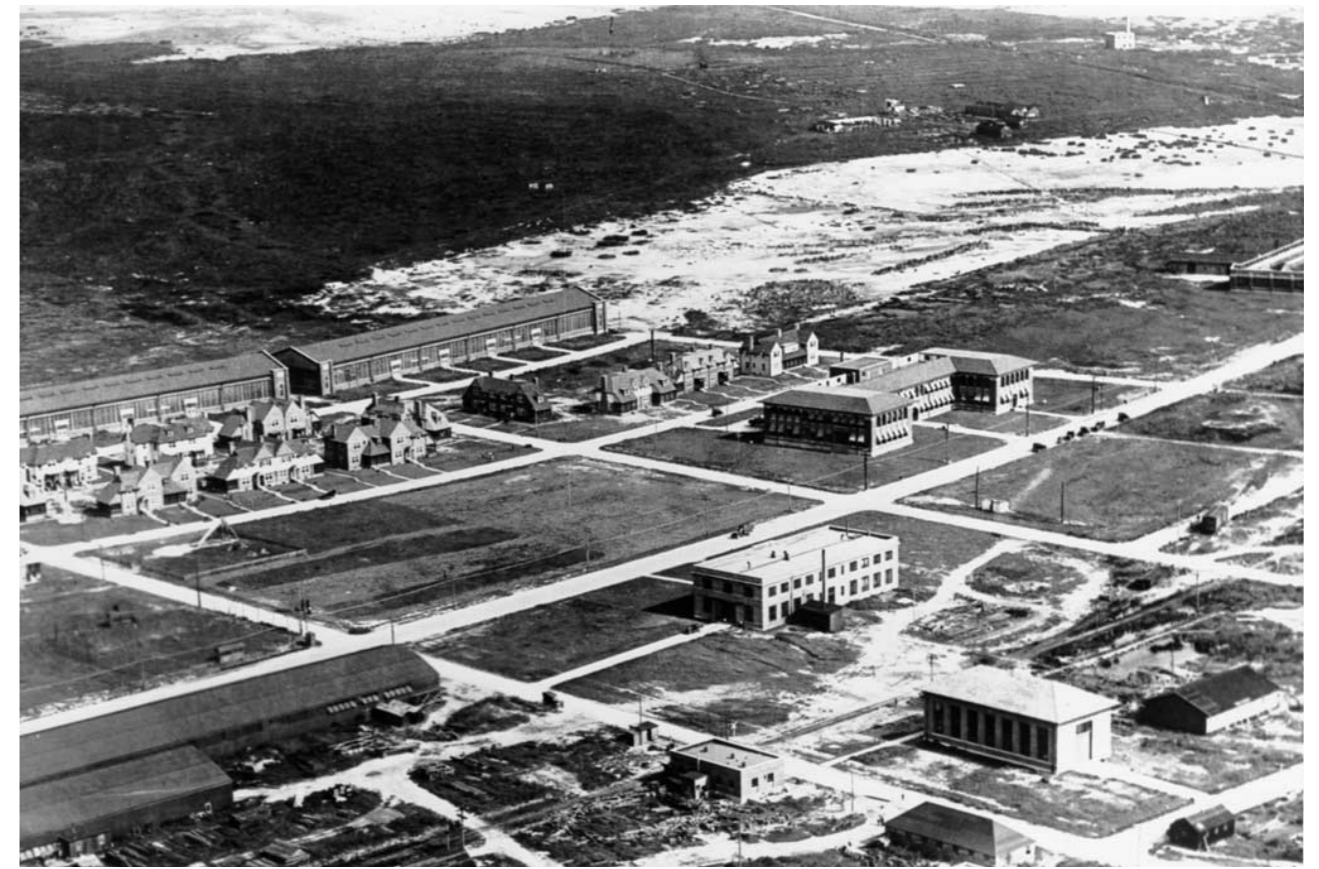


Fig 23. : Anatomy theater in Leiden that turned into Museum of Natural History, 1610



Fig 24. : The Anatomy Lesson of Dr. Deijman, Rembrandt, 1656



The transformation of research complexes has occurred in the urban scale. We can notice a significant shift from a mono-functional program to multi-program complexes.

The precursor of worldwide known NASA, NACA Langley specialized in aeronautics and developed many innovative solutions for aircraft manufacturing. Today as NASA Langley Research Center it expanded and alongside aviation technology its research focus also on atmospheric studies and space exploration.



Fig. 25 : Langley Memorial Aeronautical Laboratory, NACA, USA, 1920
Fig. 26 : Langley Research Center, NASA, USA

The historical position of research facilities was driven by the danger of contamination and more individual approach, therefore it tended to be located away from the city center.

With the shift of understanding science as a more collaborative venture, research has become embedded into the city tissue. That helped in attracting skilled workers as well as supplied with satisfactory infrastructure. The collaboration between universities and private actors emerged as both an opportunity for young researchers and, for companies, increased efficiency in recruitment.



Fig 27. : location of Karolinska Institute in the urban context, Stockholm

Before a drug can be sold in the United States, the Food and Drug Administration (FDA) must approve it as safe and effective for a particular use. However, doctors are generally allowed to prescribe drugs that the FDA has approved for one use for any other use. This “off-label use” is common and legal, but the FDA largely forbids drug companies from promoting their own products for off-label use.

What role should the FDA play in regulating off-label drug use?

In science, individual work is an outdated term. The pace of technological development and scientific advancement has necessitated collaboration not only in larger groups but also as multidisciplinary teams. Only this “set-up” can compete on the high-speed science market.

Science needs a place to express itself. Towards public opinion and among the researchers. That is one of the reasons for “the journal clubs” existence. Those particular meetings allow discussing current problematics, the taboo of the scientific world.



Fig. 28 : The example of the question raised during the debate, Southwestern Law School, 2014
Fig. 29 : The picture frame of recorded debate between Richard Epstein and Ryan Abbott, SLS, 2014

04. INVESTIGATION No. 3

Salk Institute, S.C.Johnson Wax and Mesa Laboratory

case studies

evaluating the existing laboratory buildings after years of use for
adaptability and validity

Changes in technology occur often and have direct implications on a laboratory needs. This causes that buildings struggle to keep pace with the program they were dedicated for. One either accept the fact that building will receive another life once no longer suitable, or design in a way that provides great adaptability.

60's in the USA were time of great architect's contribution to the laboratory typology. After more than half century of building's life we can notice that some of them are still valid, while other faced obsolescence.

Having an opportunity to learn from the past, the 3 iconic laboratories are being analysed.

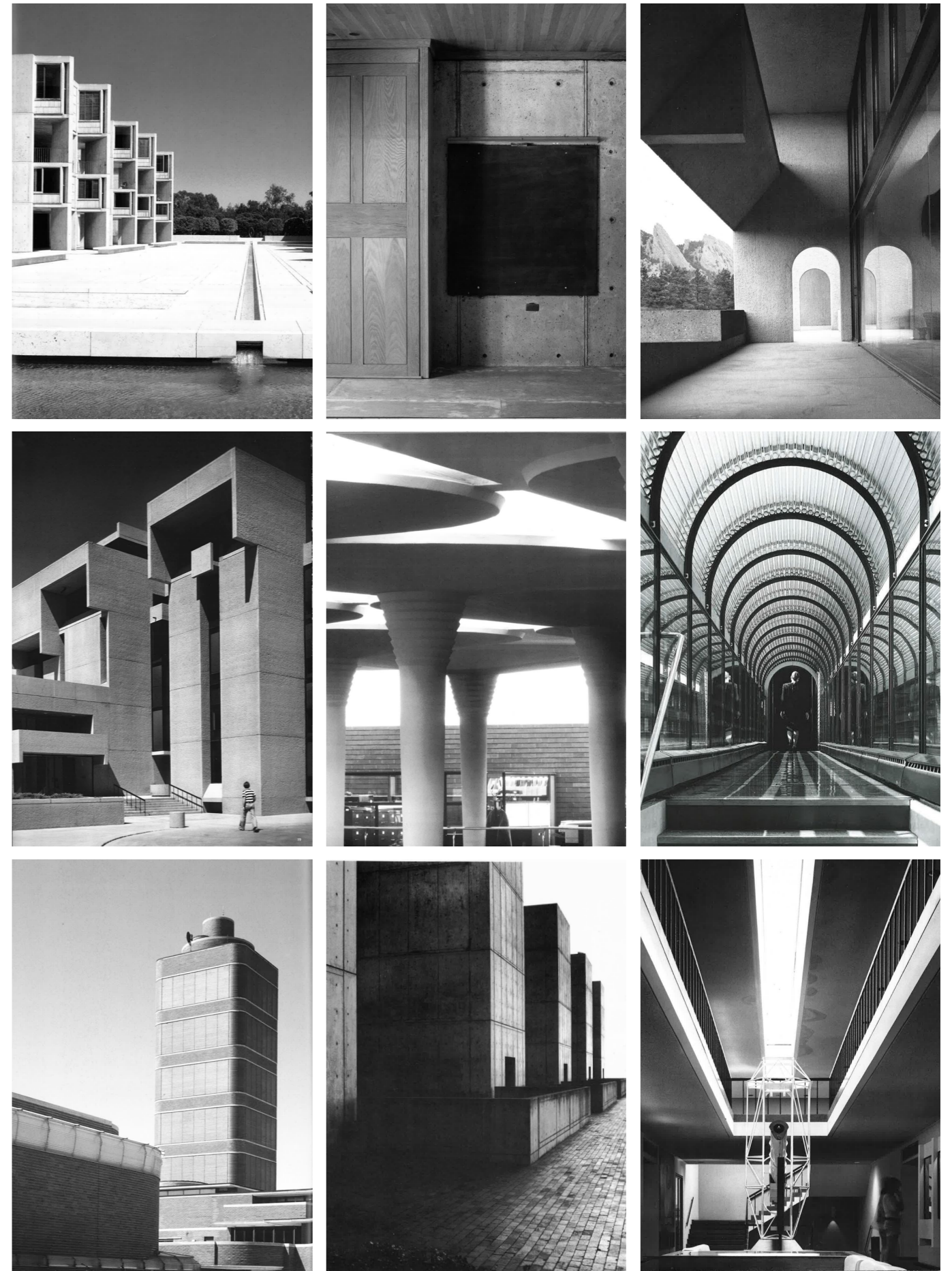


Fig. 30 : a sequence of photocopies of Salk Institute by Louis Kahn, San Diego, USA, 1965; S.C. Johnson Wax Administration and Laboratory Building by F.L. Wright, Racine, USA, 1950; Mesa Laboratory at NCAR by I.M.Pei, Boulder, USA, 1961

A lot of effort was dedicated to separate “study rooms”, spaces where scientists’ creative thinking is stimulated, with the laboratories. Those special offices (4 per one block) align in section with the mechanical level. This gesture protects from direct insight. Only symbolic bridges connect study rooms with laboratories, creating a psychological separation.

Two rectangular blocks have 3 stories of laboratory space, above which thirteen Vierendeel beams give space for mechanical service of a total height of 2.75 meters. Those generous service areas provide a flexible supply of spaces underneath. At the end of each block, there is an additional mechanical room.

Interstitial space and mechanical infrastructure constitute more than half of the footage of the buildings.

When built, areas for mechanical service were much more generous than needed. This came as a result of architect thoughts on future flexibility. Indeed this additional cost was repaid many times over years of use.

HVAC has a seven-year cycle to accommodate changes that occur in the functional program and the needs of the future research activity.

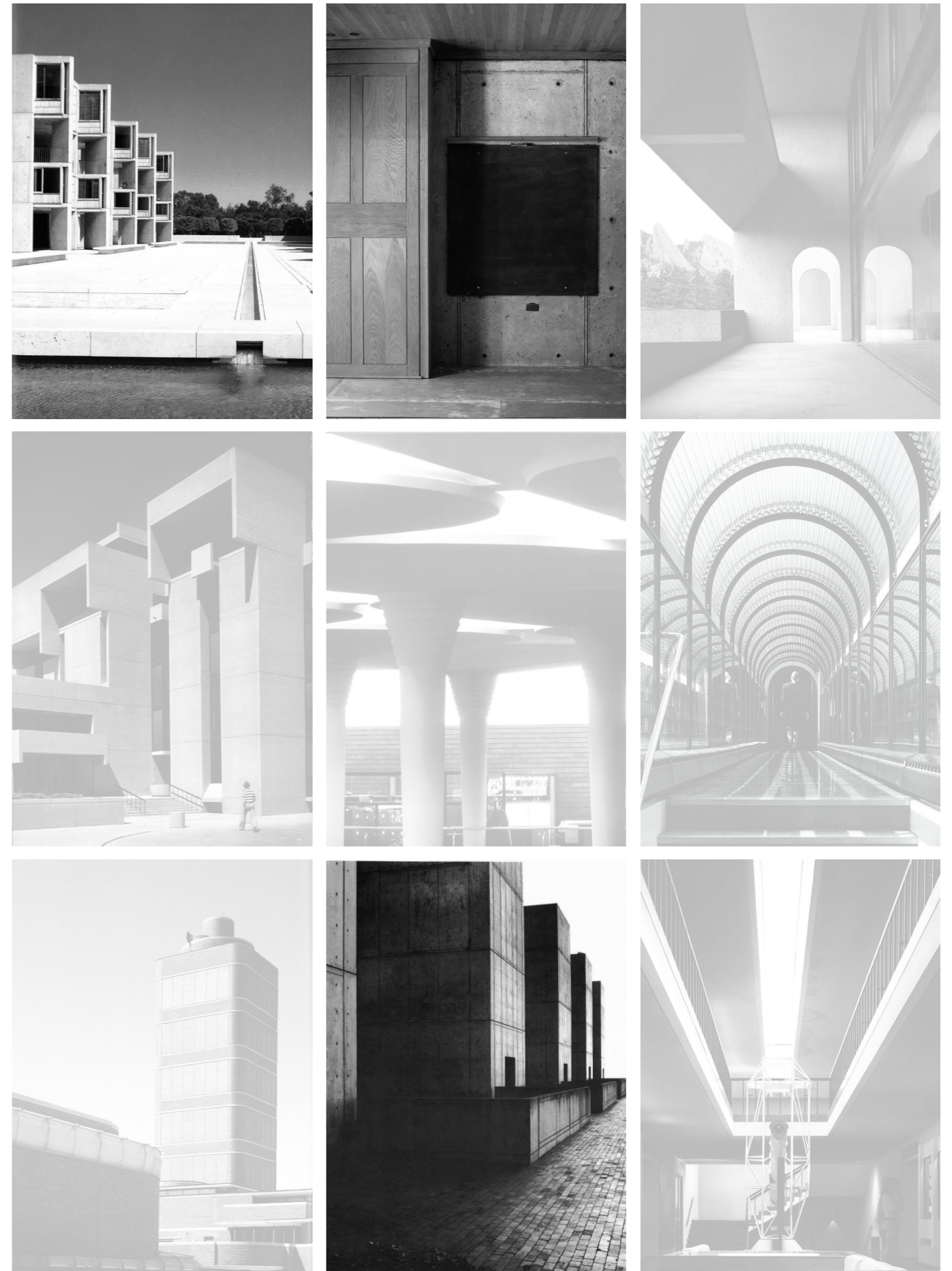


Fig. 31 : a sequence of photocopies of Salk Institute by Louis Kahn, San Diego, USA, 1965

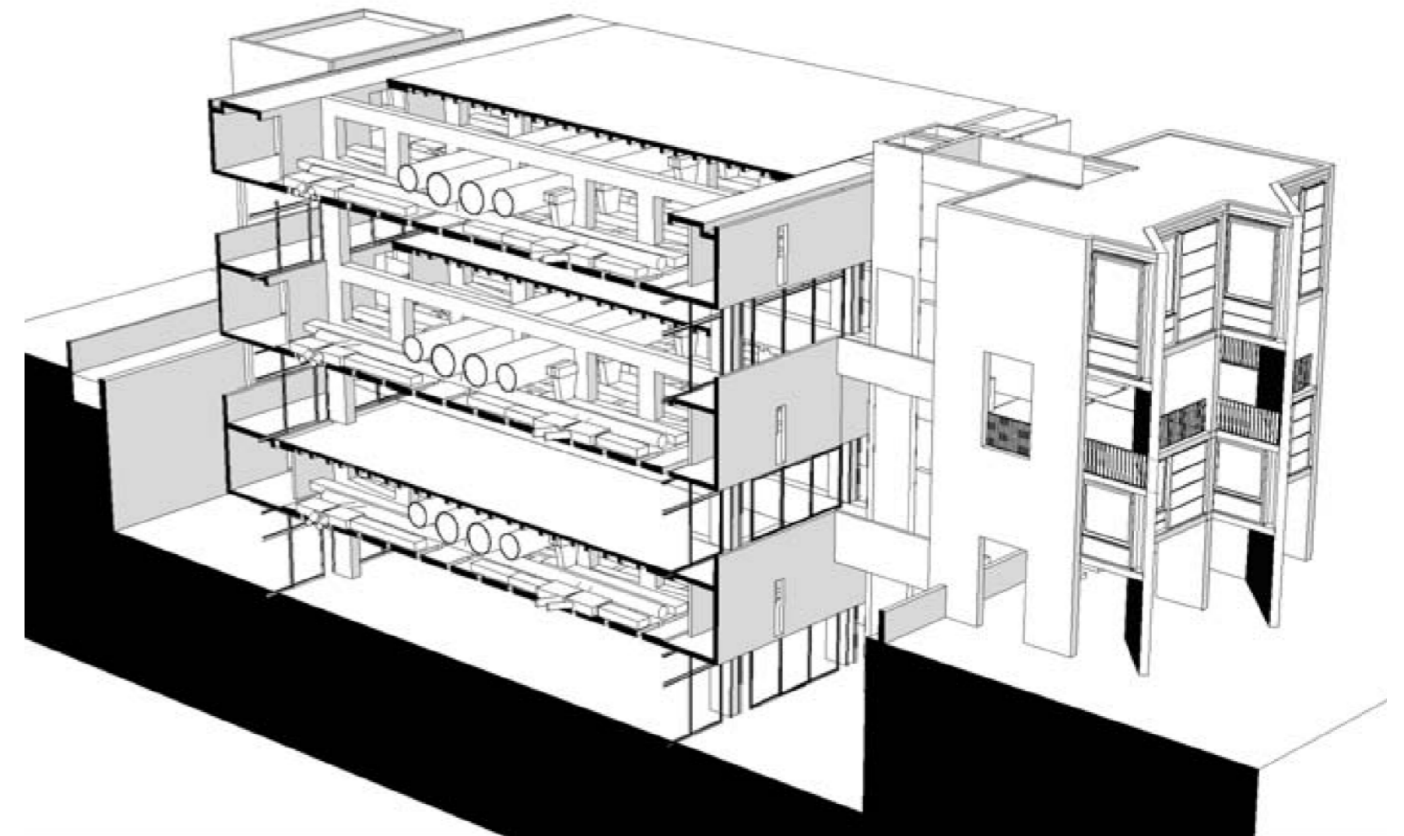
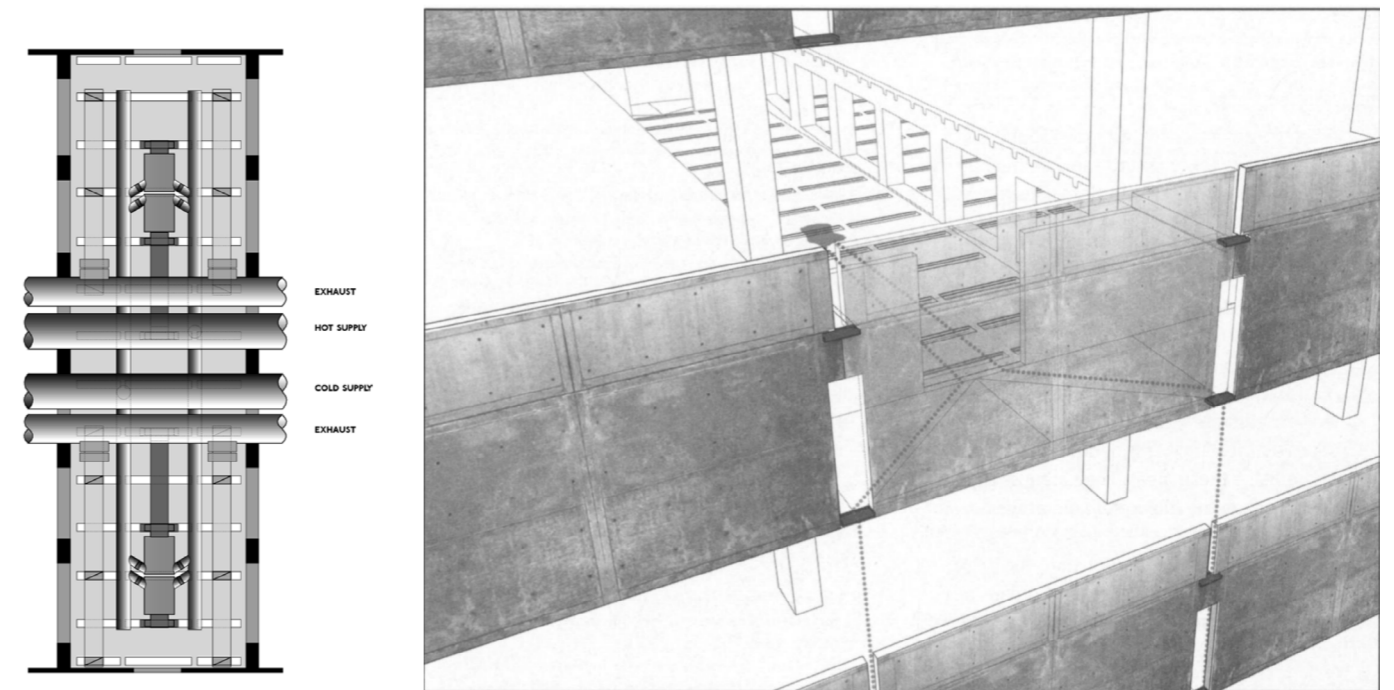
The uninterrupted research has driven many technological solutions within the building. Doubled systems all over the building (including the heating with the complex's own co-generation plant) allowed for maintenance work to be conducted on one of the systems, keeping the other one functional.

A high-temperature water system has been chosen instead of steam as the main energy source (less maintenance in comparison to steam, like in Johnson Wax). Discharged energy from the heated water produces space heating, space cooling, domestic hot water, and steam for laboratory sterilizers. The complex needs to be freshly ventilated. Re-circulation is prohibited due to the potential hazards. The Dual-duct system controls the temperature in all the zones.

The architect's details show an amazing understanding of processes happening inside the laboratory. Post-tensioned Vierendeel truss slightly cambers the floor of the pipe space upwards, protecting the laboratories from eventual flooding due to the system failure. Flexible ceiling striations slots are locked/open depending on the need and keeping the dust away from the sterile workspaces.

Kahn has foreseen great longevity of materials, working with materials such as concrete based on Roman Pozzolana (known for its strength) and teak wood (known for low maintenance need).

There is no conventional reception hall. This has been replaced by the plaza. Many critics highlight the lack of a clear public entrance and circulation system, which makes it difficult for visitors to find their way into the complex.



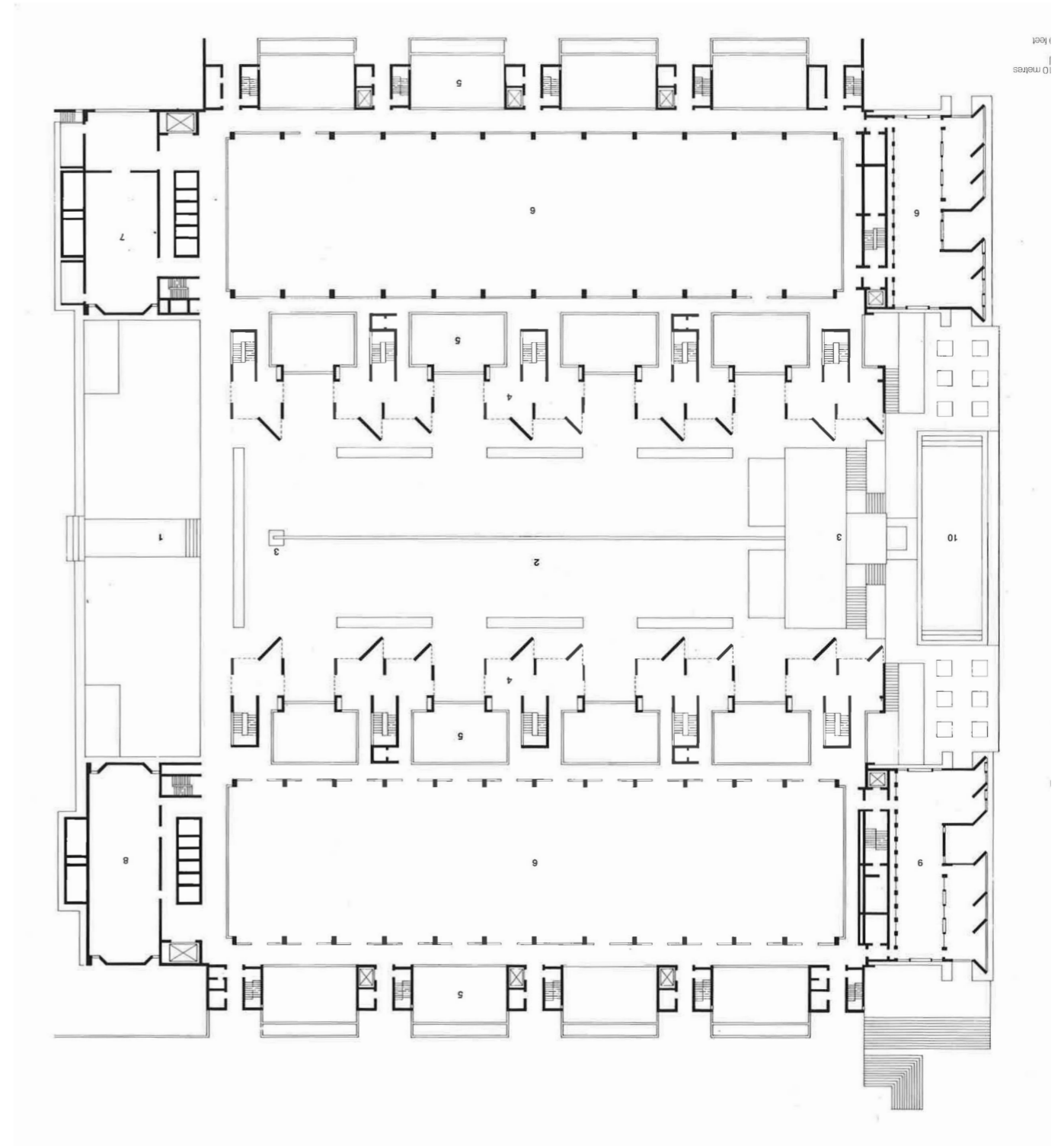


Fig. 33 : Facade towards central court, photography by Peter Aprahamian
Fig. 34 : Ground floor plan at laboratory level, drawing by Ann Knudsen, John Hewitt

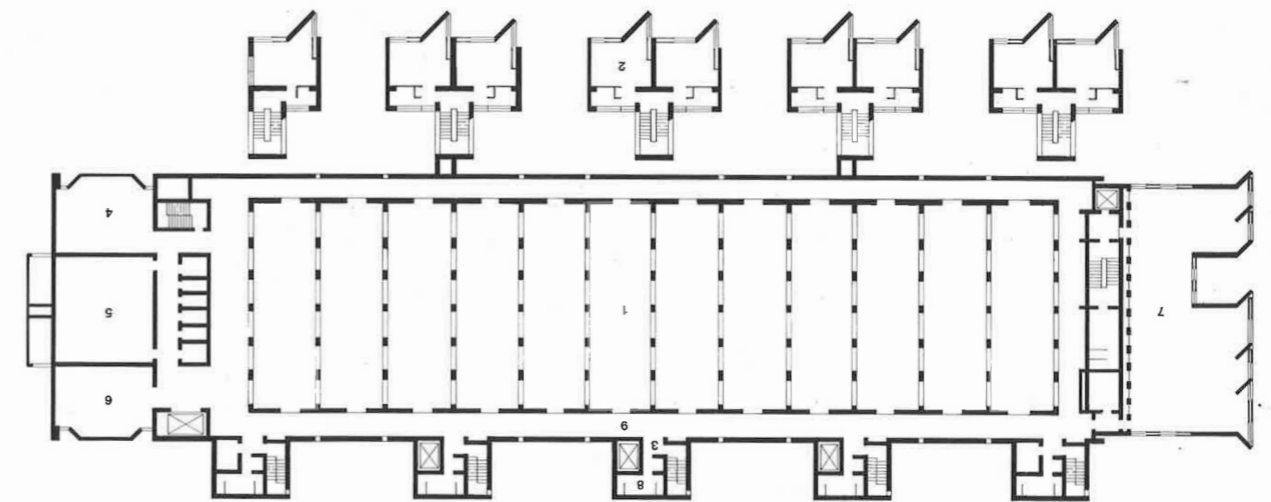
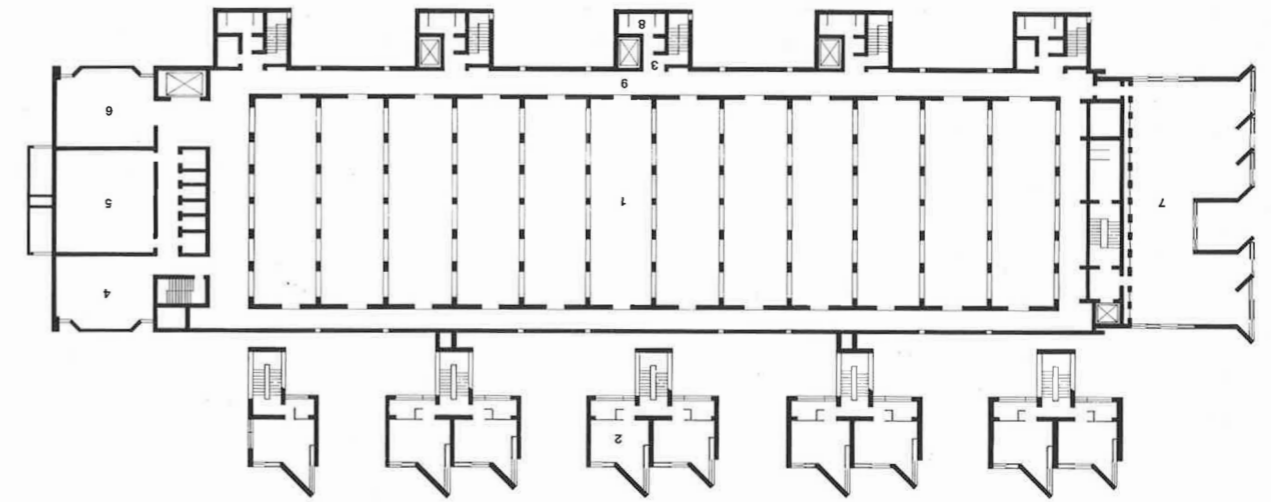


Fig. 33 : Facade towards central court, photography by Peter Aprahamian
Fig. 34 : Ground floor plan at laboratory level, drawing by Ann Knudsen, John Hewitt

The Administration Building for Johnson Wax was raised as first one, the tower came after a great success of the first building investment (as addition).

Sam Johnson (the president of the company) "We achieved international attention because that building represented and symbolized the quality of everything we did in terms of products, people, the working environment...".

First, it was proposed to Johnson to develop a laboratory as two-story building. Wright proposed the tower, arguing for the reduced overall length of utility distribution routes compared to the horizontal-spread building of similar floor area.

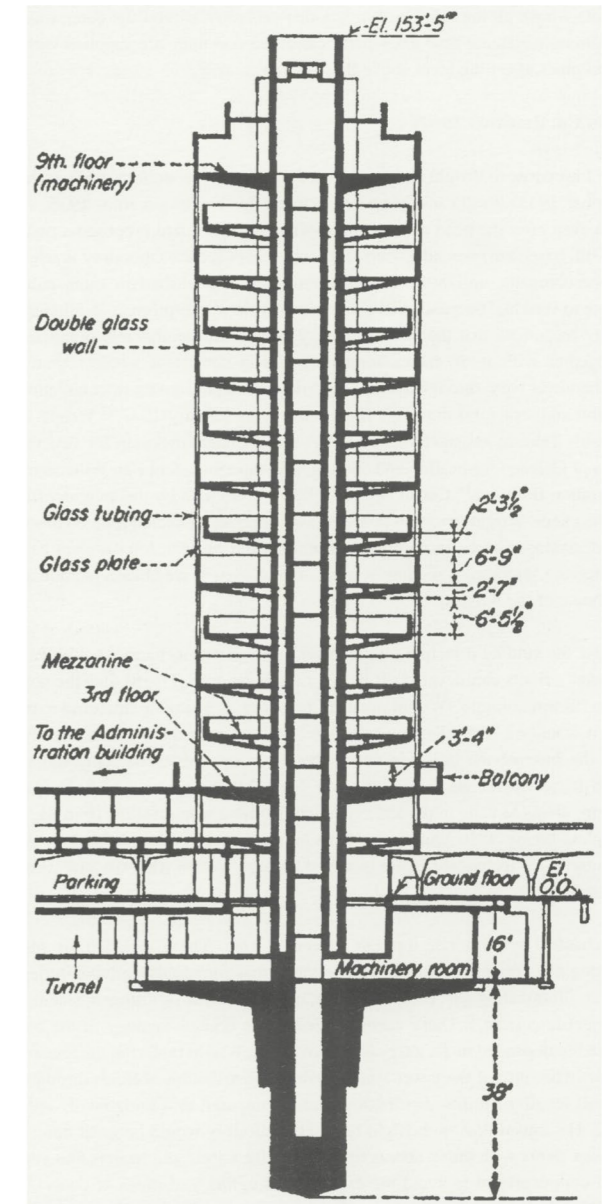
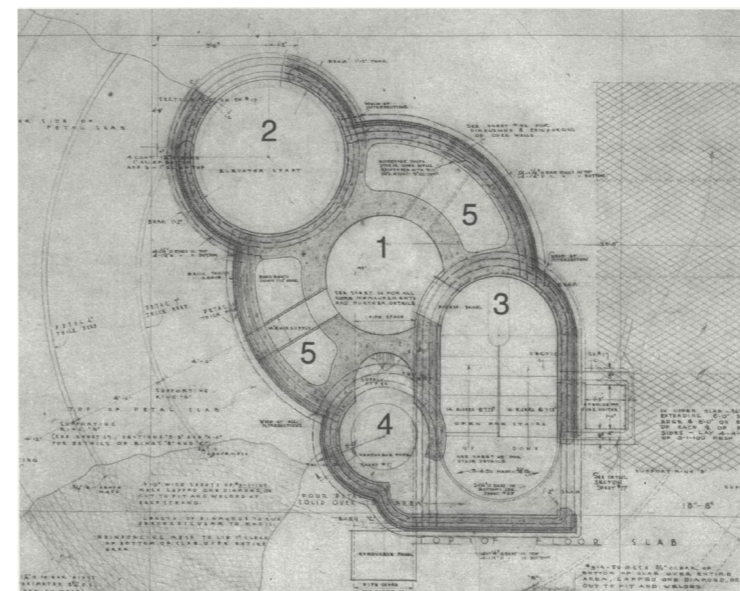
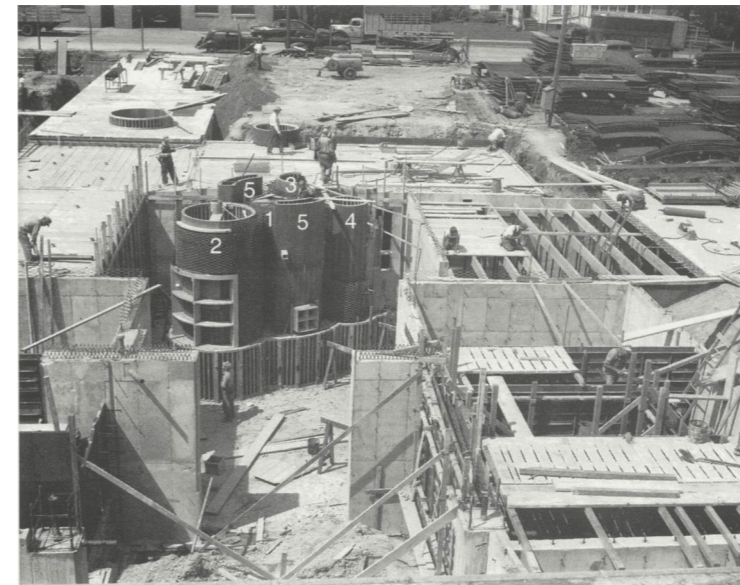


Fig. 30 : a sequence of photocopies of Salk Institute by Louis Kahn, San Diego, USA, 1965; S.C. Johnson Wax Administration and Laboratory Building by F.L. Wright, Racine, USA, 1950; Mesa Laboratory at NCAR by I.M.Pei, Boulder, USA, 1961

There is vertical segregation of departments within the laboratory tower (considered as an attribute at that time - not anymore). Duct-system is cast in the hollow reinforced-concrete floors, connecting to the vertical hollow of the core.

“All utilities and the many intake and exhaust pies run in their own central utility grooves arranged like the cellular pattern of a tree trunk,” said Wright explaining the idea. Glass walls hang from the floors.

Concrete shafts are hollowed to house vertical circulation, amenities, and service risers. At that time the laboratory space seemed to be efficient and flexible - a great amount of natural light, column-free, uncluttered by service risers. Even though the floor spans only two meters from the core to the external glass. A range of special custom-made furniture had to be made to fit this one-only building due to its architectural form. Pyrex tubing + inner glazing to provide a more effective weathertight solution (after partly failure of glazing system at the administration building).



After 50 years of being in use, it is still in good condition due to the client's dedication to maintaining it, the Administration Building is still functioning just as it was planned.

However, when it comes to the laboratory, the size of the floor area, only one stair, restricted floor to a mezzanine height determined lack of long-term flexibility and made expansion impossible. Wright's idea of the organic architecture, where systems are highly integrated, proved to be constraining. It limited the opportunities for the addition of new serving systems, as consequence restricted the use of laboratories.

In addition to that, the glazed facade caused many problems like leakage and overheating.

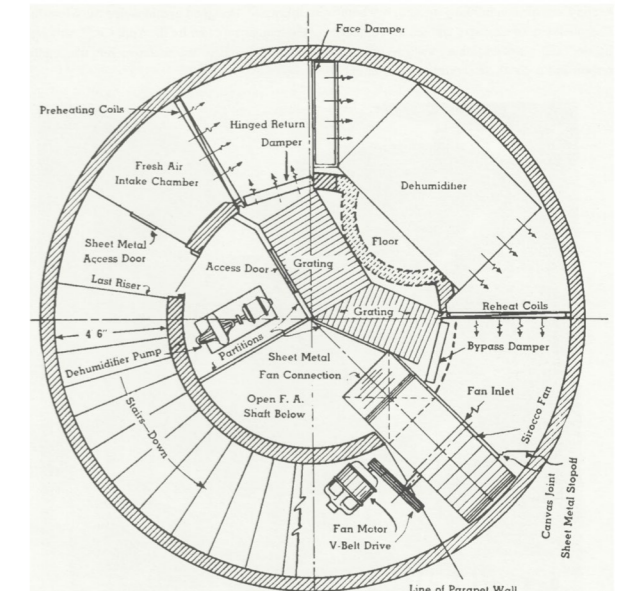
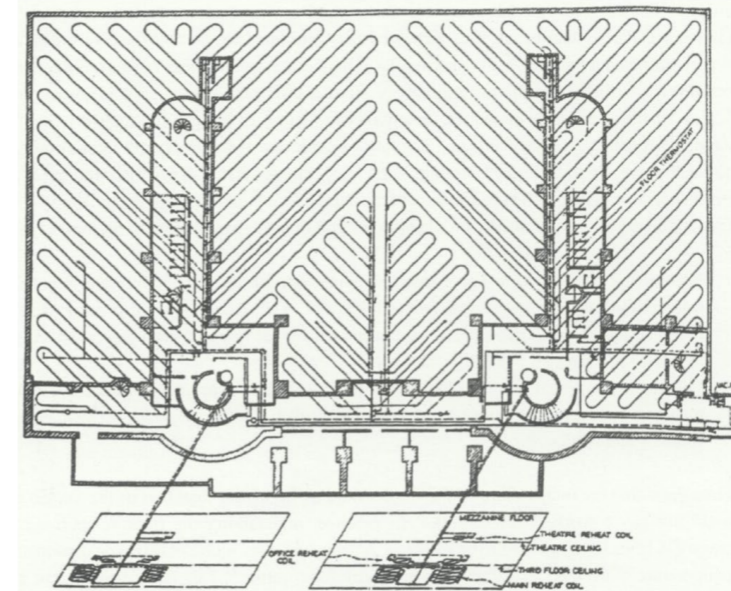
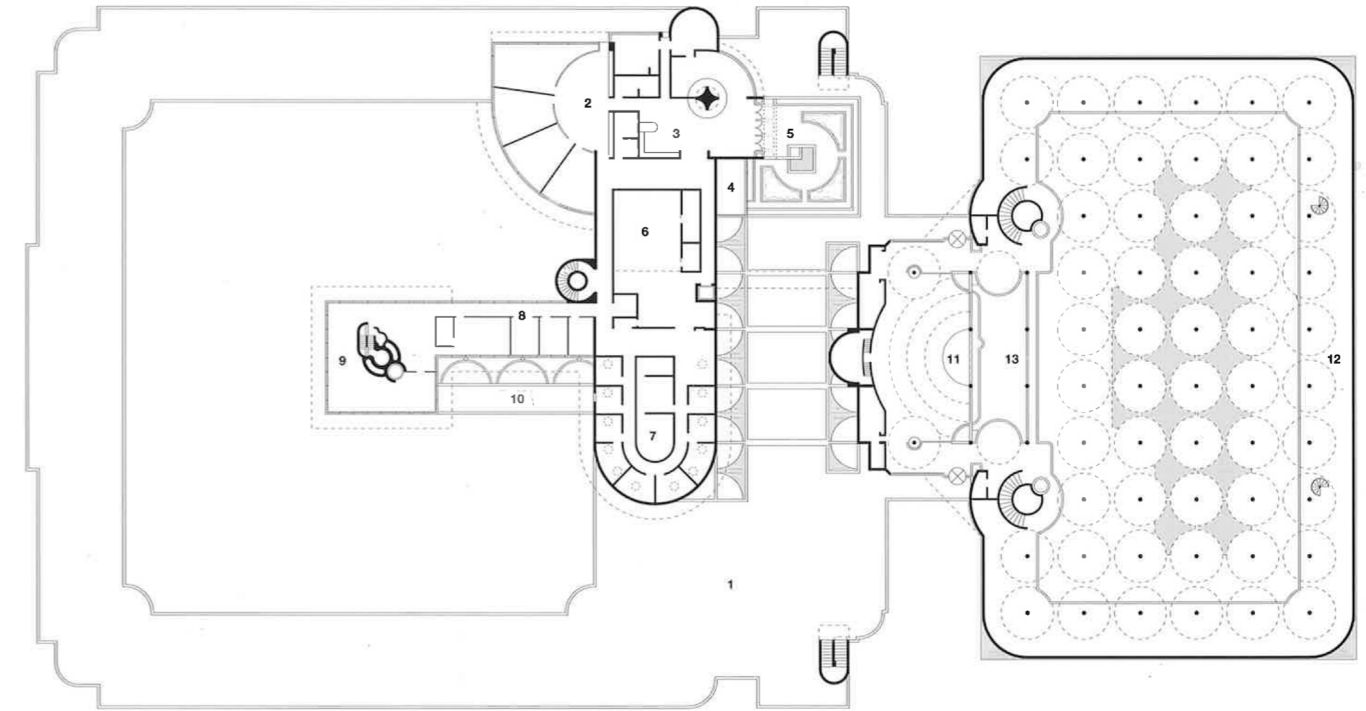


Fig. 35 : The example of the question raised during the debate, Southwestern Law School, 2014
Fig. 36 : The picture frame of recorded debate between Richard Epstein and Ryan Abbott, SLS, 2014

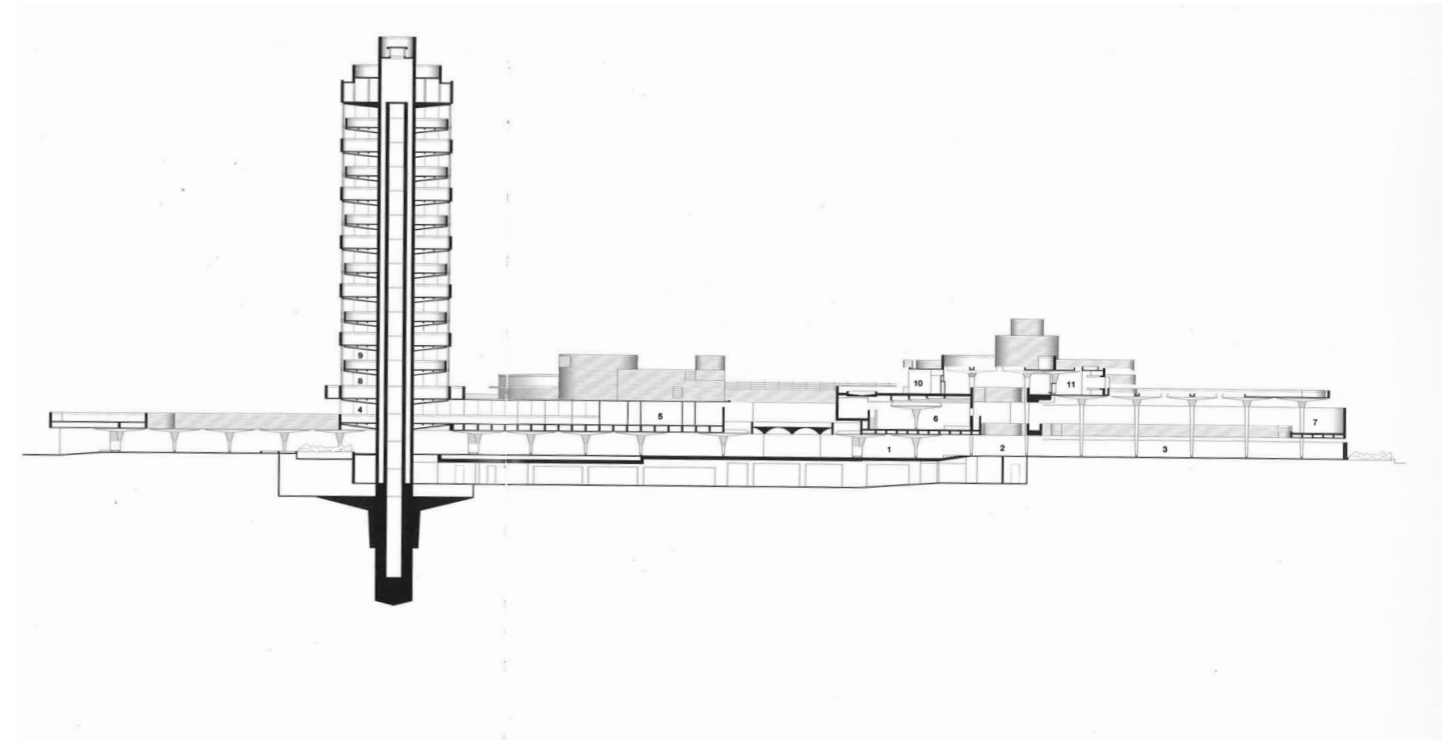


Fig. 35 : The example of the question raised during the debate, Southwestern Law School, 2014
Fig. 36 : The picture frame of recorded debate between Richard Epstein and Ryan Abbott, SLS, 2014

There was a close collaboration between I.M. Pei, Richards, and scientists during the work on the campus. The brief for Mesa Laboratory was unusual for this typology, stating that the scientists would be working in small teams, the circulation has to be complex, and one should avoid long corridors and homogeneity. The scientists also requested the possibility of more private contemplation within the complex. The interference between several thousand people visiting NCAR every year and the staff was to be reduced to a minimum.

The achieved result was highly appreciated. Smaller spaces were clustered, facing more public areas. Pei has also managed to accommodate for easy conversion of space from one purpose to another. Each room received a lot of wall space, perceived as some sort of flexibility for personal expression - hanging up graphs, mounting shelves, etc.

As complex has been growing radically over the years, many changes applied to the initial vision. However, the building has delivered the creative environment it was designed to.



Fig. 30 : a sequence of photocopies of Salk Institute by Louis Kahn, San Diego, USA, 1965; S.C. Johnson Wax Administration and Laboratory Building by F.L. Wright, Racine, USA, 1950; Mesa Laboratory at NCAR by I.M. Pei, Boulder, USA, 1961

The use of glass in the building is minimal, taking up barely 10 percent of the exterior. This has to do not only with the flexibility of the interior but also because of the site-specific conditions. Both the sunlight and wind are strong on the hill, additional wall surface protects the interior from heat gains/losses. Additional permutations and cantilevers overhang the form and act as extra protection.

Despite a small number of openings in the form, Pei wanted the researchers to look out between day-to-day activities to gain inspiration from nature. The complex has been equipped with 30 balconies and numerous viewpoints from inside of the building, mainly in the circulation path. For windows tinted glass has been used.

Due to the budget cuts, only 2 towers have been raised. One referred to as "wet" designed for laboratories with piped water, compressed air, and other gases and venting fumes through exhaust hoods. The ductwork accessible shafts and ceiling.

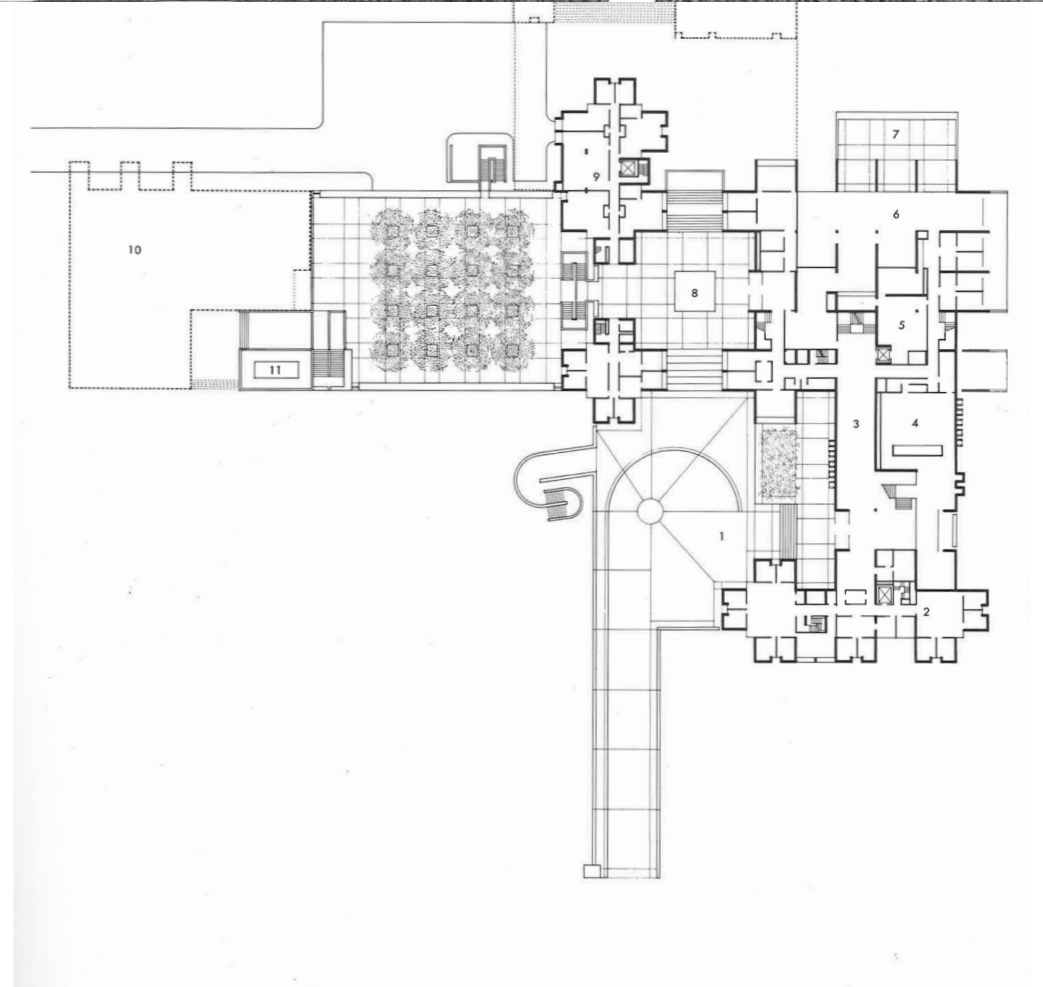


Fig. 37 : View on laboratory tower, photography by Y. Futagawa&Associated Photographers
Fig. 38 : Ground floor plan, Global Architecture Magazine

A lot of radical experiments took place in Mesa Laboratory forcing radical changes in the interior. Large vertical wind shaft in which droplets could be studied running through the floors, rooms with -40 celsius to study snow and ice (now moved outside Mesa) among others.

Each year 5-10% of the building is being remodeled. It is being constantly extended since the number of people has increased significantly. Including additional volumetrics around the site. The computing addition, completed in 1977, reflects changes in technology not foreseen when the building was designed.

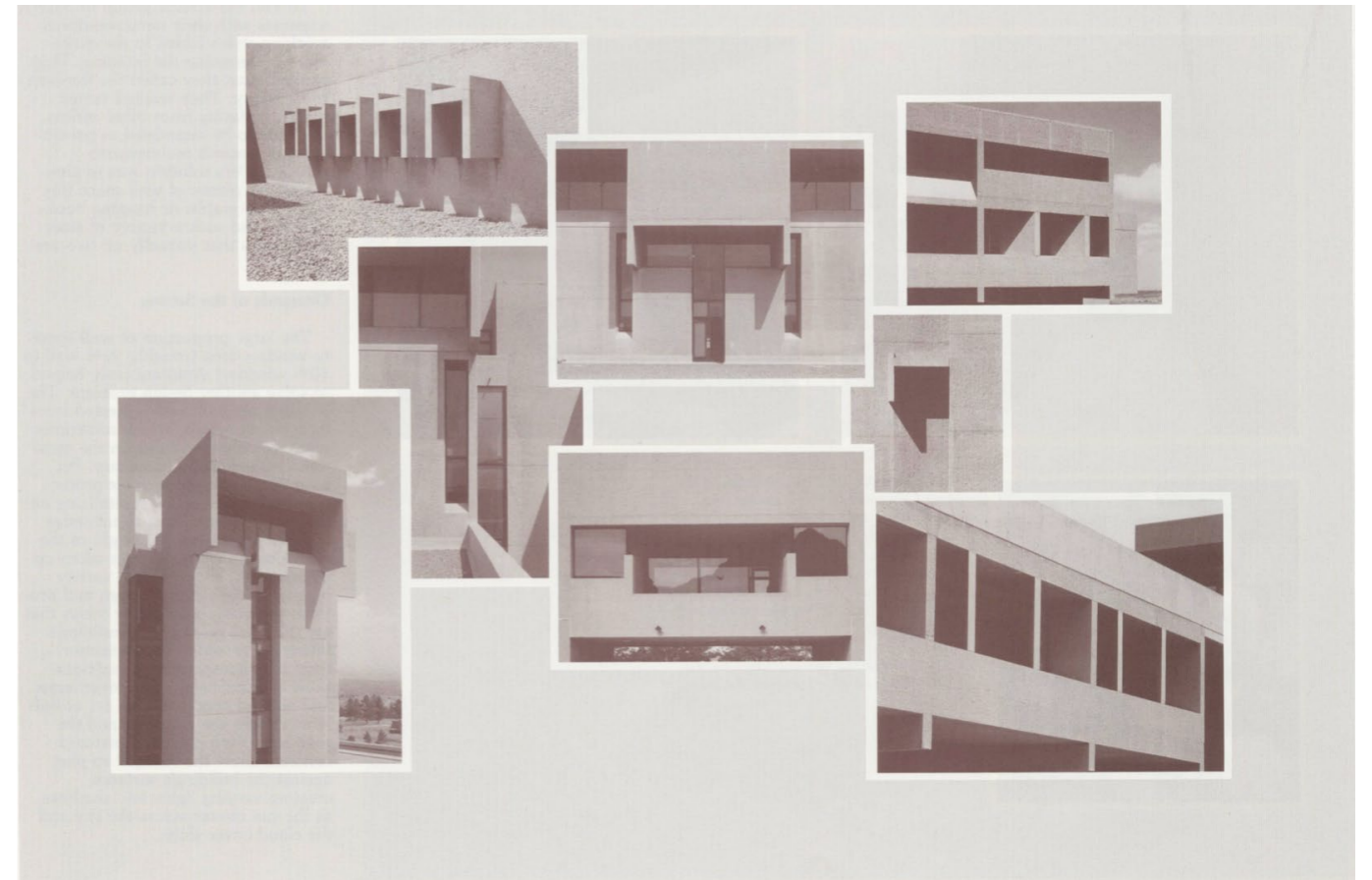


Fig. 37 : View on laboratory tower, photography by Y. Futagawa&Associated Photographers
Fig. 38 : Ground floor plan, Global Architecture Magazine



Fig. 39 : The picture frame from "Sleeper" by Woody Allen, 1973

05. INVESTIGATION No. 4

intentions, believes and fears

introducing openness

the characteristics of contrasting spaces, border condition,
juxtaposition and the role of architecture

collage no. 1

architecture as a mirror of social changes

(rising accessibility to knowledge, curiosity of the public, increasing interest in science)

Undeniably, we as society are more and more interested in what happens in the sciences and the media has become an arena of speculation and debate on the future and ethical issues of research. Scientists are looking for a place to express themselves, especially in the topics including moral question.

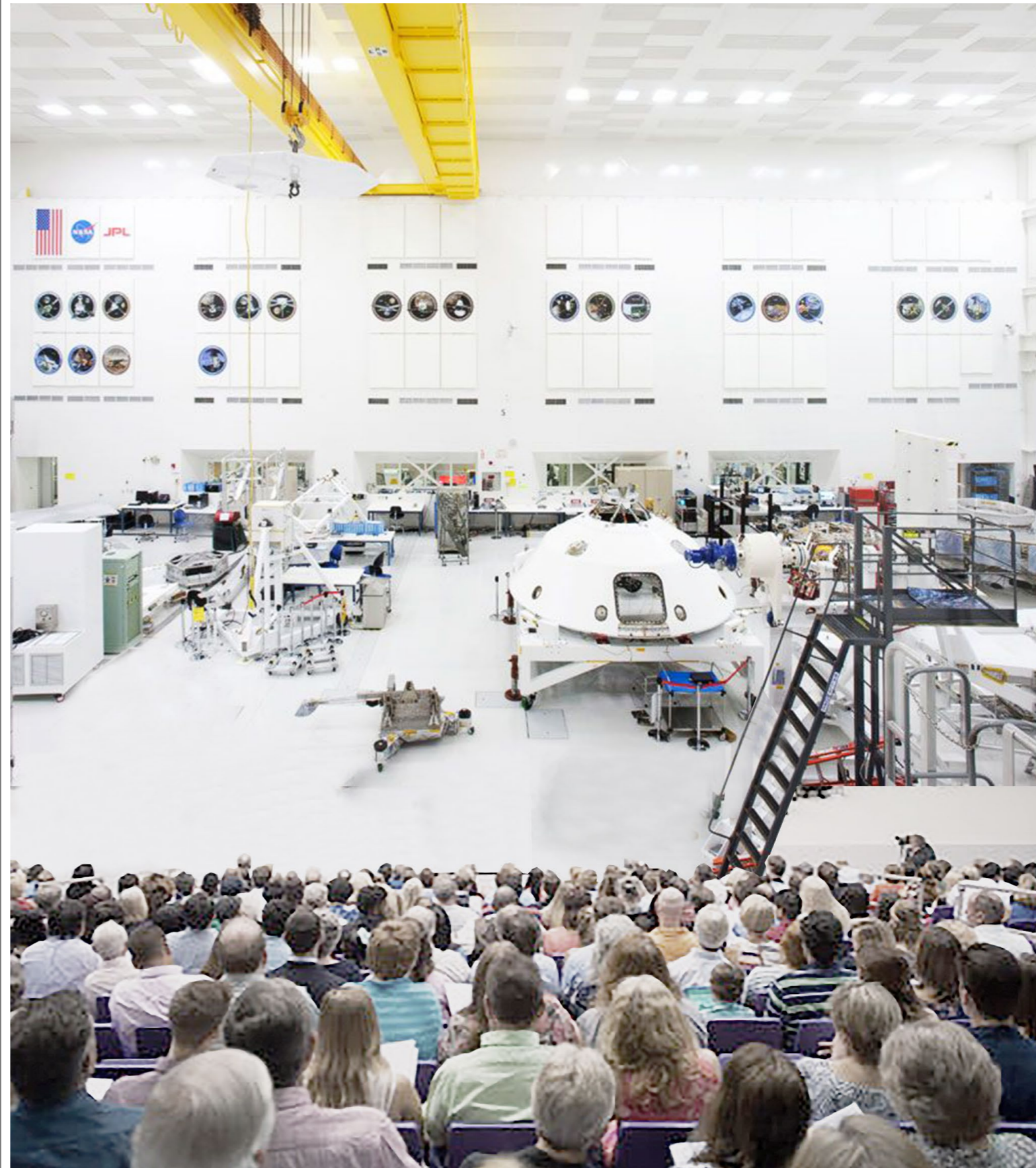


Fig 40. : architecture as a mirror of social changes, collage; author

collage no. 2

architecture as a socio-spatial element

(juxtaposition, consequences, product and producer of public interactions)



Fig 41. : architecture as a socio-spatial element, collage; author

06. INVESTIGATION No. 5

artificial and natural light, airflow, circulation

technical requirements

and the architectural opportunities behind them

NANOTECHNOLOGY

In nanofabrication facility the yellow light is necessary because photolithography is a primary use of the facility, and shorter wavelengths of light can interfere with fabrication using such processes - similar to a darkroom for photographic film production.



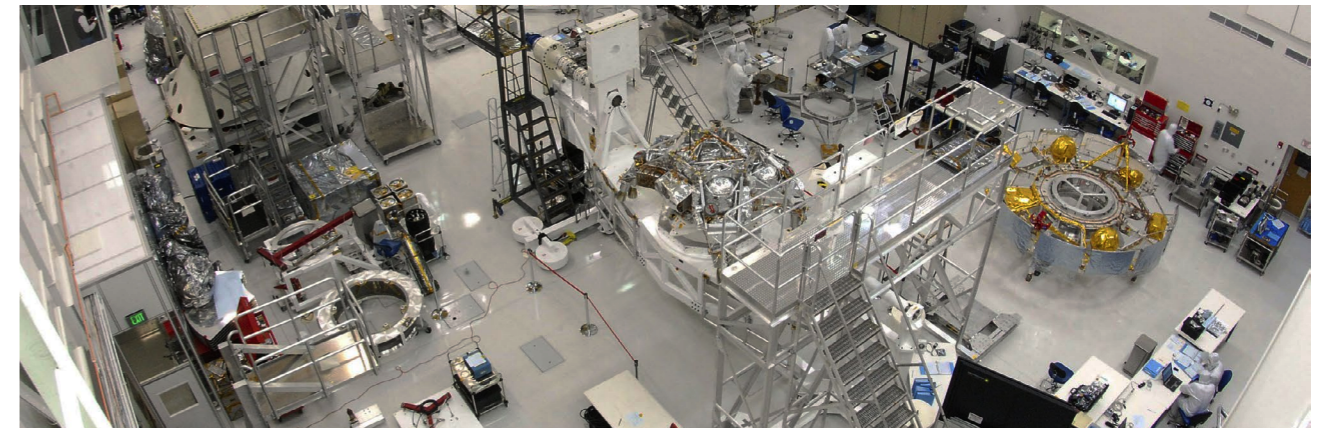
FOOD MANUFACTURING

Indoor vertical farms with full electric lighting are able to modulate the spectrum to fit plant needs. Red and blue lights are often used, being highly active for photosynthesis.



AEROSPACE SCIENCES

Facilities of spacecraft assembly halls aim at providing diffused light with constant focus on all the areas within its border. This improves the quality of working conditions, where often objects are of various sizes.



OPTICS AND PHOTONICS

The optical amplification, focused light, is the main character in such a room. In order to protect the reliability of the result the other light source intensity is under controll. Often the experiment takes place in the enclosed part of the room/device.

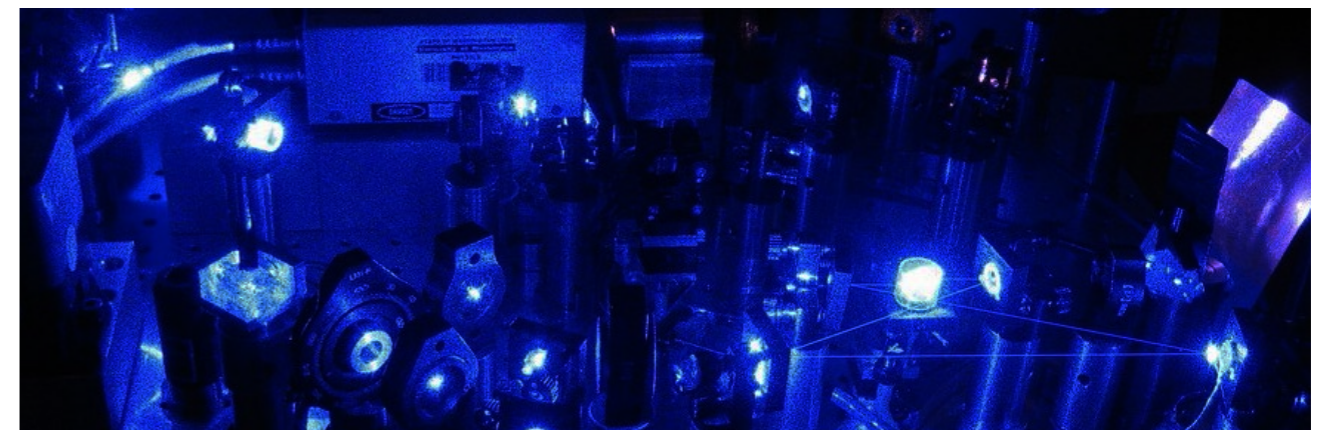


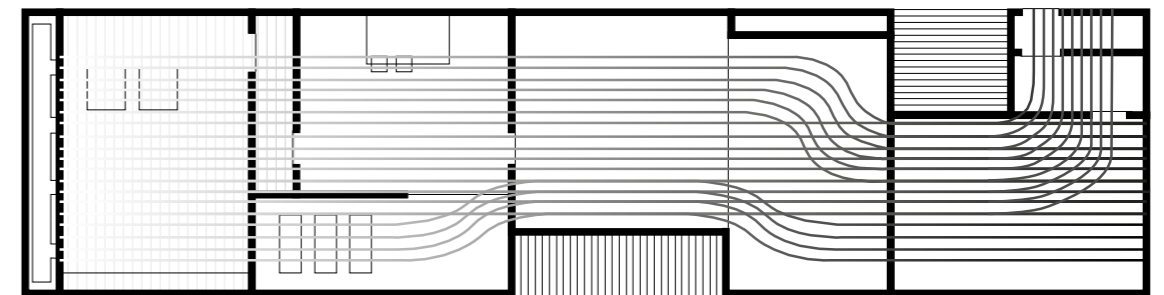
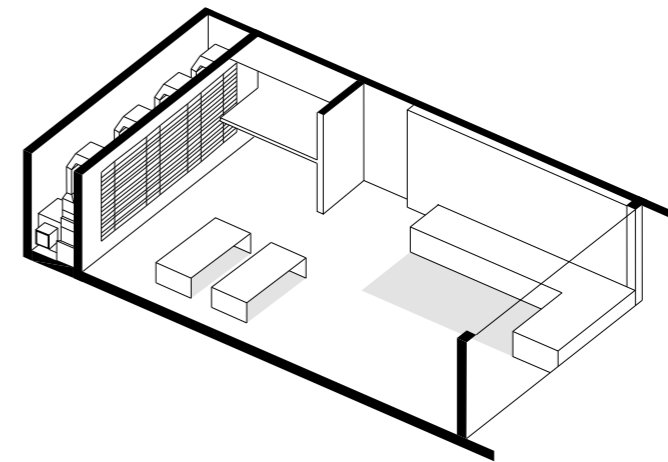
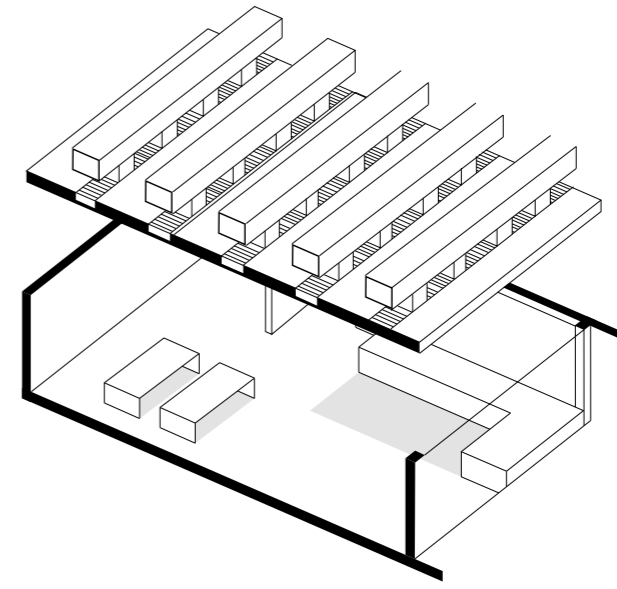
Fig. 42 : nanofabrication facility of the Molecular Foundry, Lawrence Berkeley National Laboratory, USA

Fig. 43 : Indoor farming facility, Detroit, Michigan, USA

Fig. 44 : High Bay 1 cleanroom, Spacecraft Assembly Facility, NASA, Pasadena, California, USA

Fig. 45 : Frequency quadrupled IR laser, experiment

Unidirectional flow of the air as the most efficient - highest class of control over indoor environment, air flow movement from the cleanest space to the dirtiest, use of airlocks

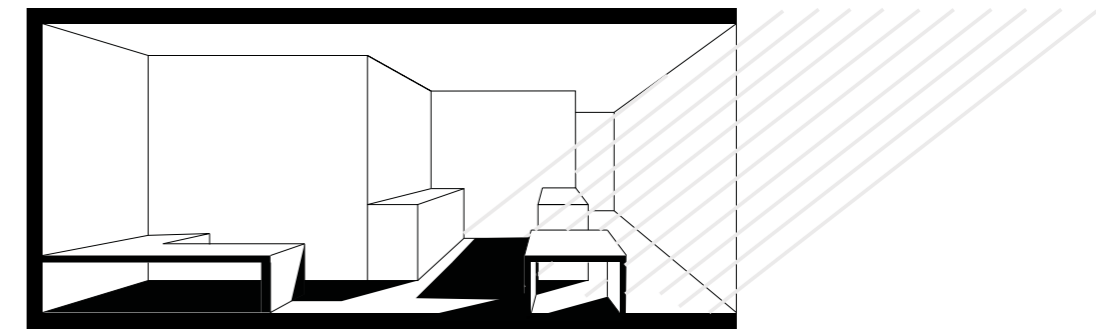


highest air purity ← → lowest air purity

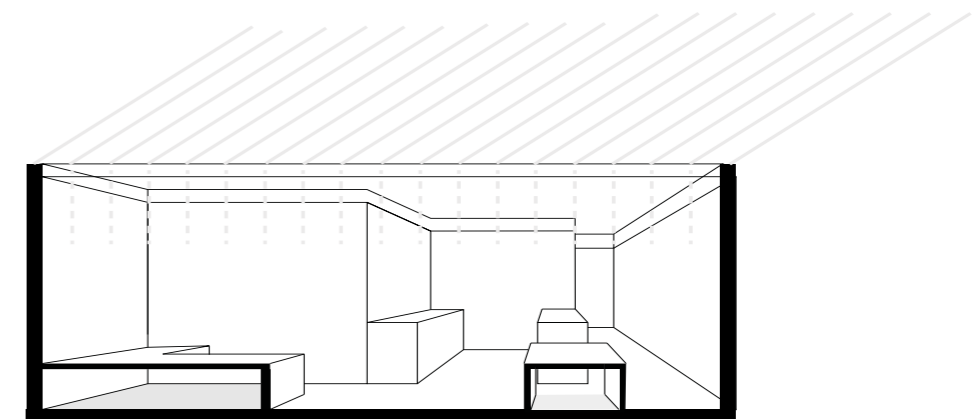
The natural light can not only create a healthier workplace, but also enhance the process itself. Research shows that it helps to focus, increases the productivity, boosts the energy level. Although it can be so beneficial, in laboratory direct natural light is not always welcome.

The artificial environment of the laboratory often requires the highest possible control over lighting source and intensity. Therefore diffused light, with controlled level of rays transition is more appropriate.

The “human-centred” spaces within building such as offices and research rooms, which require creativity and focus, are functioning much better with direct light source.



direct light - rays reflection, strong shading, high contrast, reduced visibility, non-uniform lighting
insight outdoors, comfort, natural state



diffused light - precise vision, precise temperature control, enclosed, even distribution of light, light shading, restructured rays, unnatural state

07. INVESTIGATION No. 6

urban strategic and site

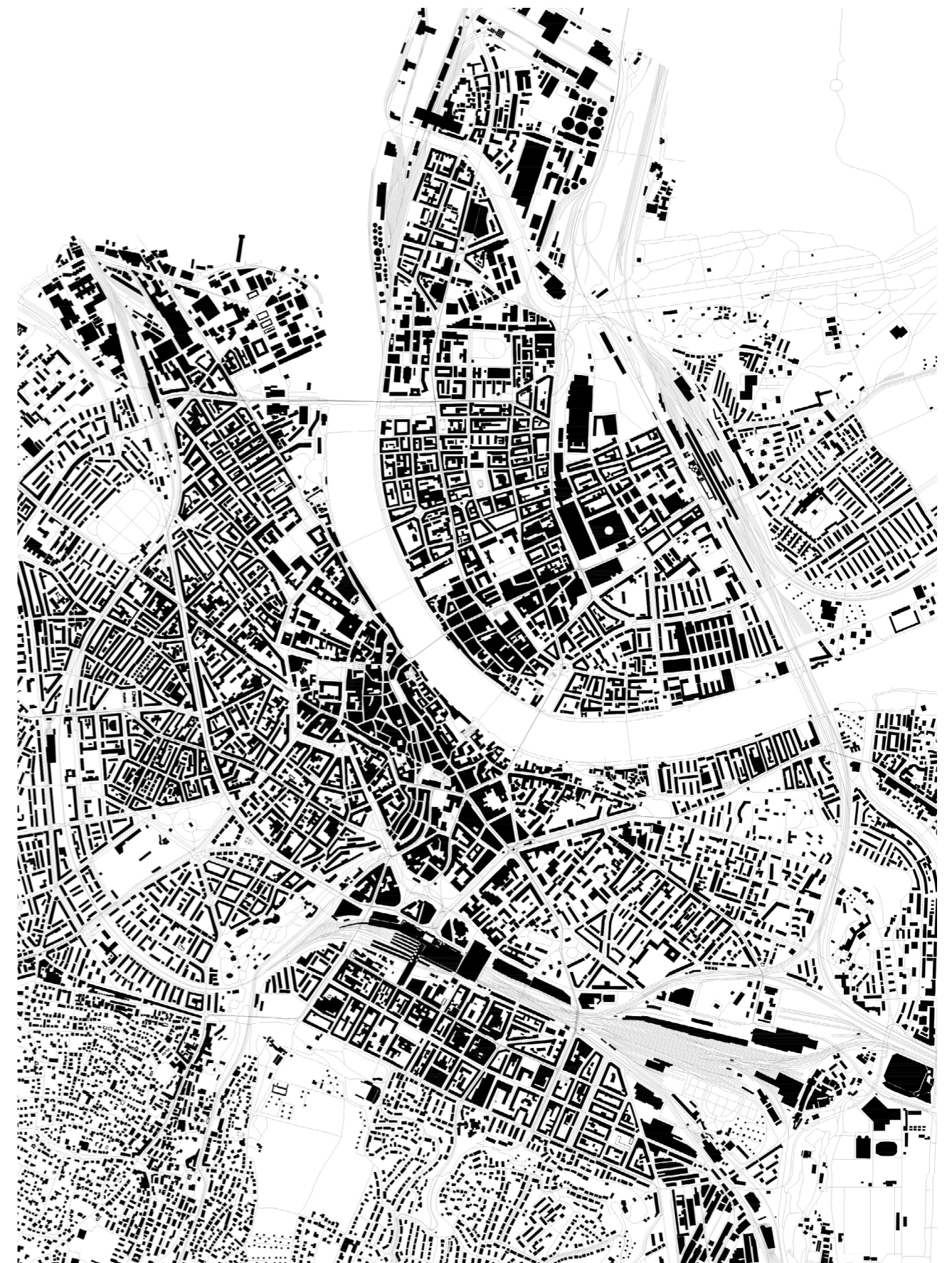
general information about the site

and main strategic urban decisions

BASEL, SWITZERLAND

population: 177,595

density: 7,400 sq. km



BASEL, SWITZERLAND

world no. 7 index for corporate research institutions

NOVARTIS

BASF
MEPHA
STRATPHARMA

MEDARTIS AG
LONZA

BAYER

SYNGENTA
ROCHE

STRAUMANN GROUP



OVER 700 COMPANIES

LARGEST SHARE OF ADDED VALUE IN THE BASEL REGION

WORLD LEADING LIFE SCIENCES COMPANIES

choice of the site - Voltamatte,
northern part of the city, with a proximity to the river, railway station, well developed
road infrastructure and the border with France







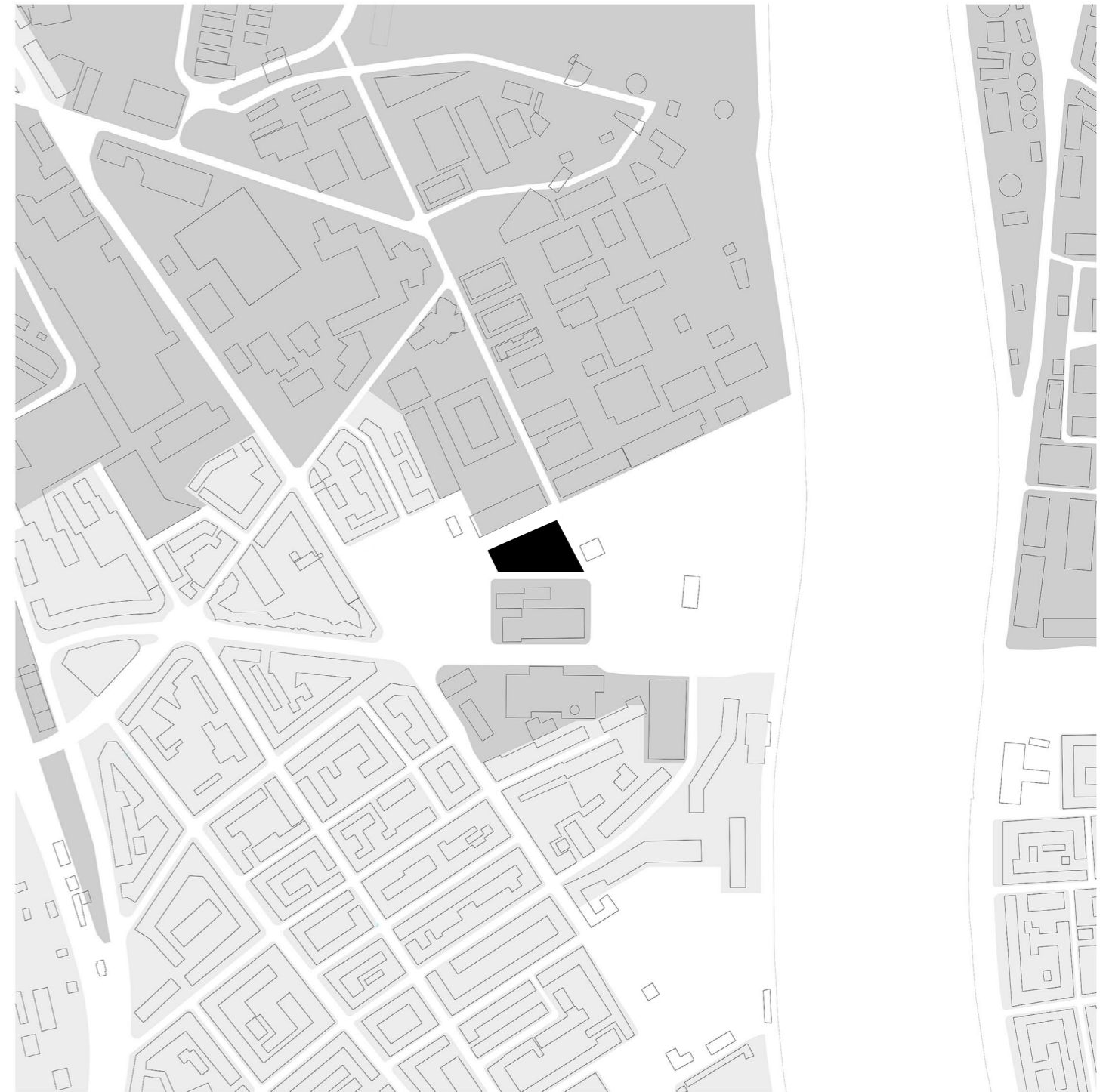
HOUSING, LIVING DOMINANT

INDUSTRY, WORKSPACES DOMINANT

site model photo,
colours symbolizing the difference in the program that city offers



choice of the site - a proximity to the river, railway station, well developed road
infrastructure and the border with France



creating a connection between the park and the river (to the right)
and the designed plaza (to the left)

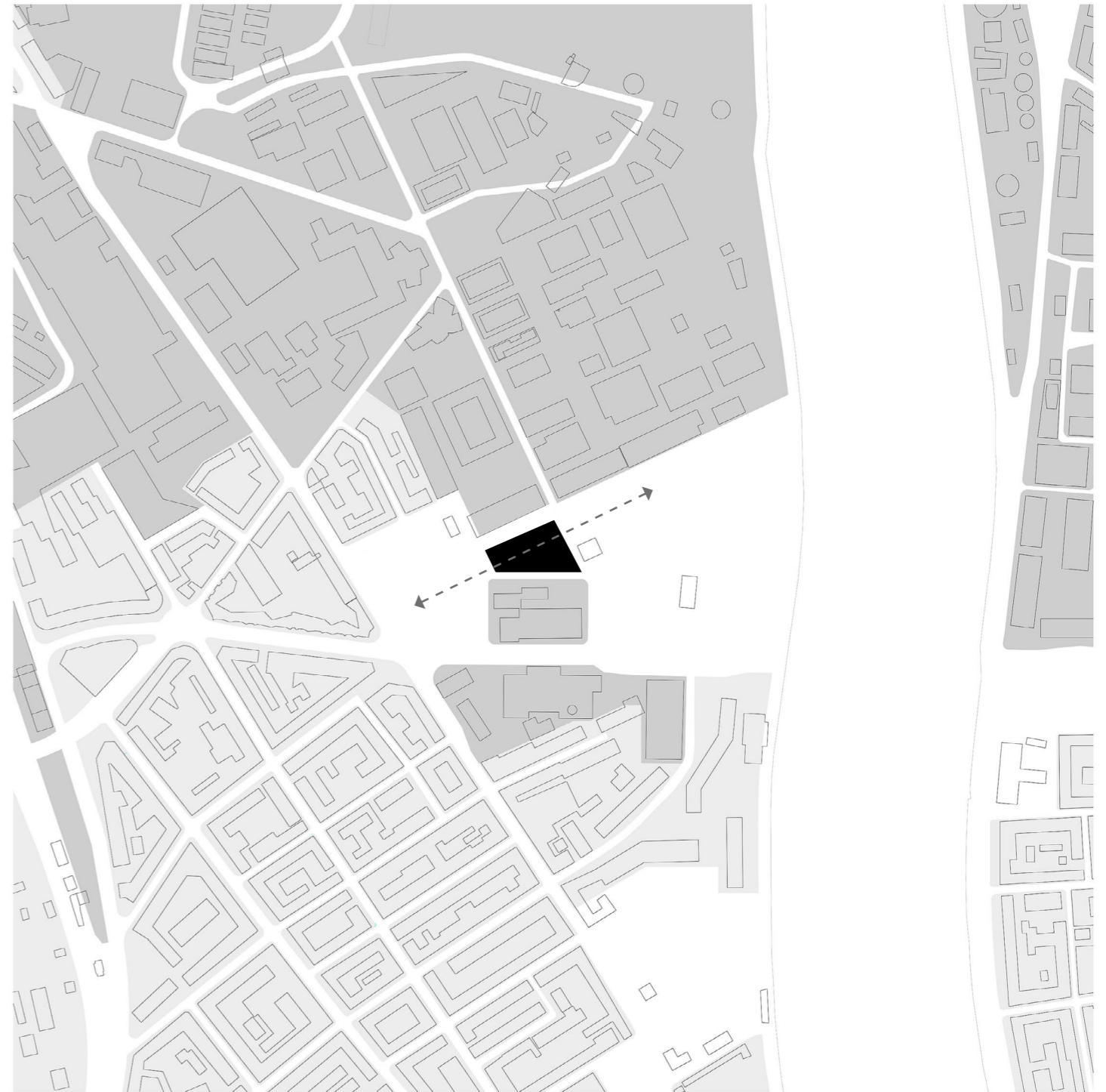




Fig. 58 : site visit, photo: author





Fig. 60 : site visit, photo: author



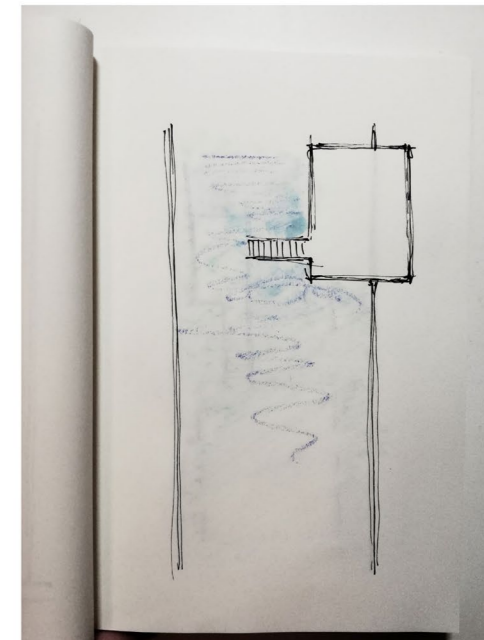
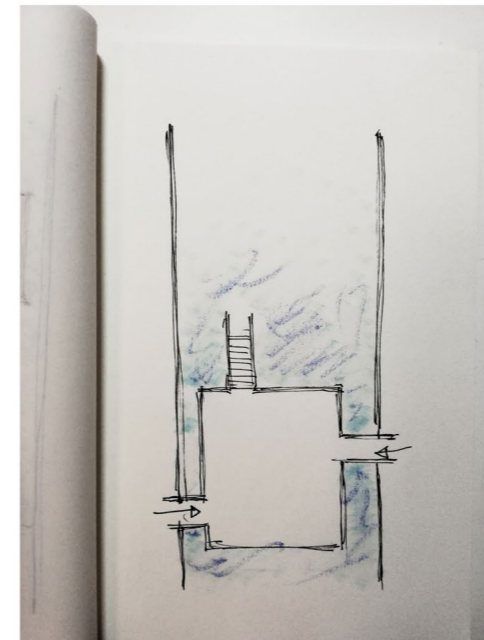
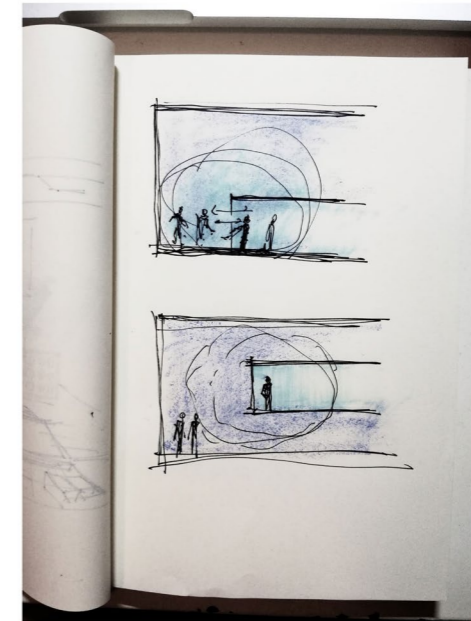
Fig. 61 : site visit, photo: author

08. INVESTIGATION No. 7

form-finding process and idea

registration of the process of idea finding,
simultaneous to the research process

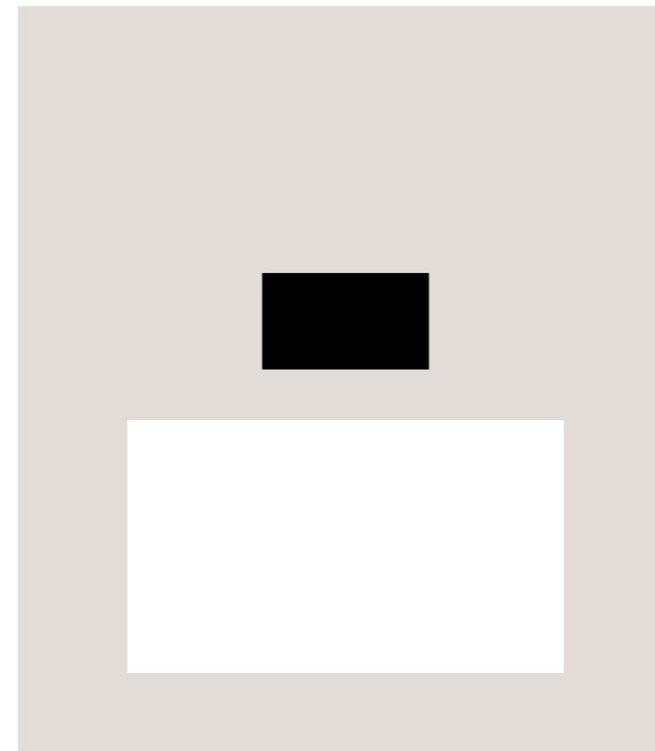
initial sketches and thoughts



idea collage - working on spaces with different characteristics



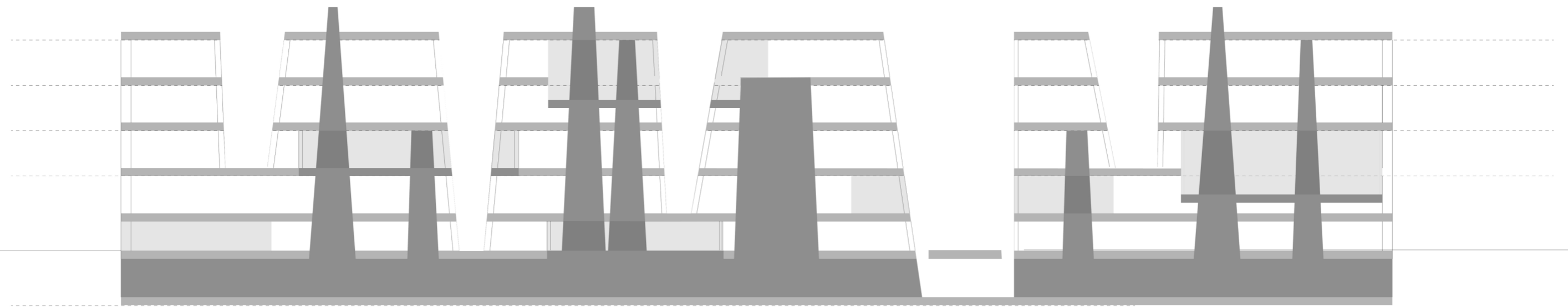
idea collage - working on spaces with different characteristics



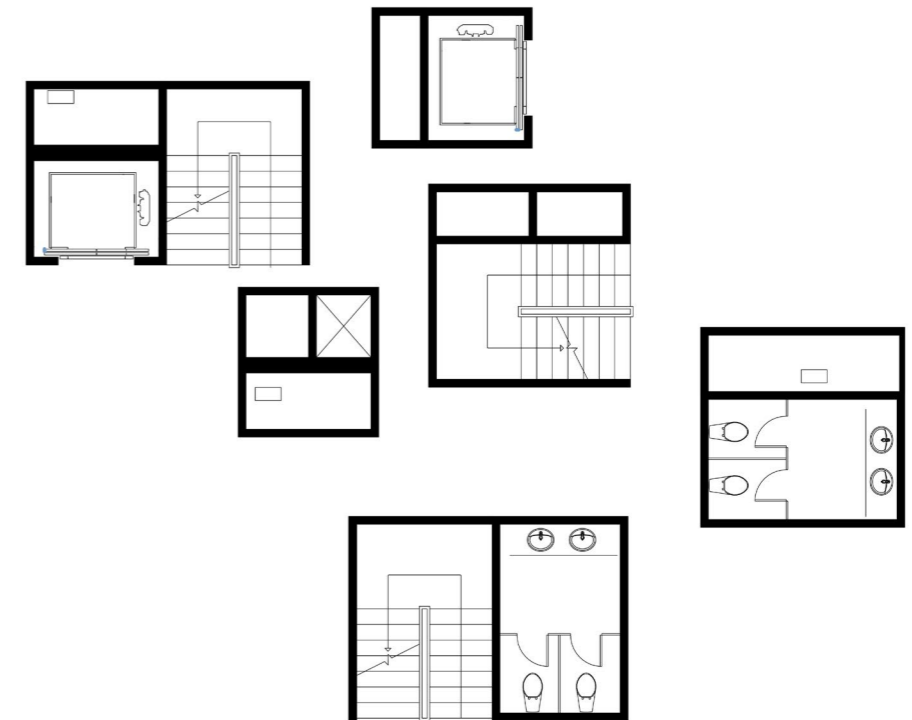
WORKING

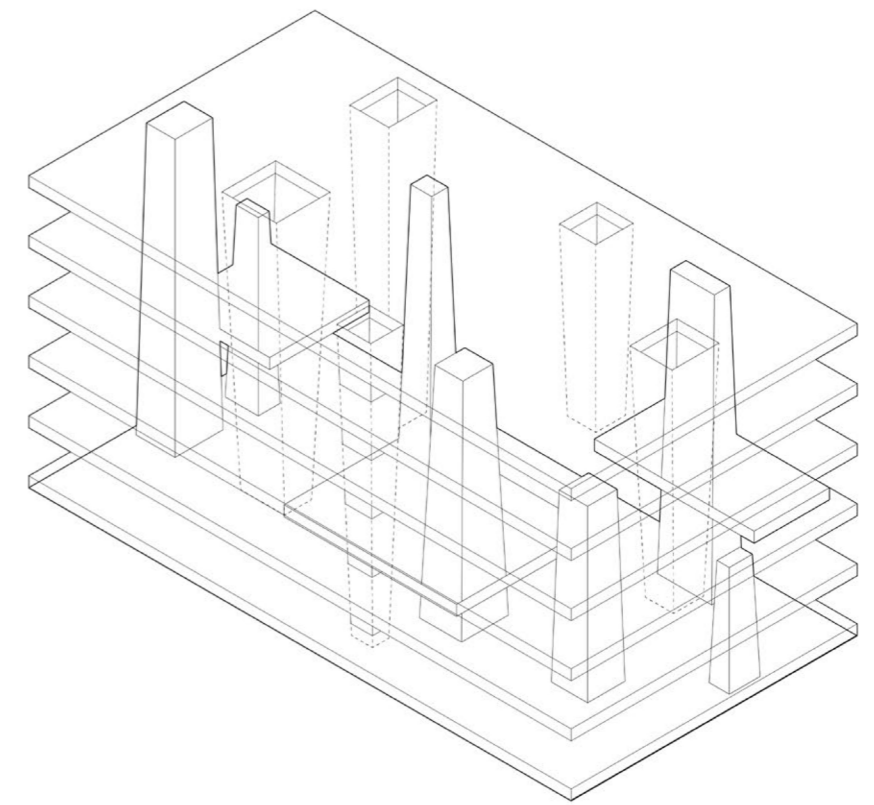
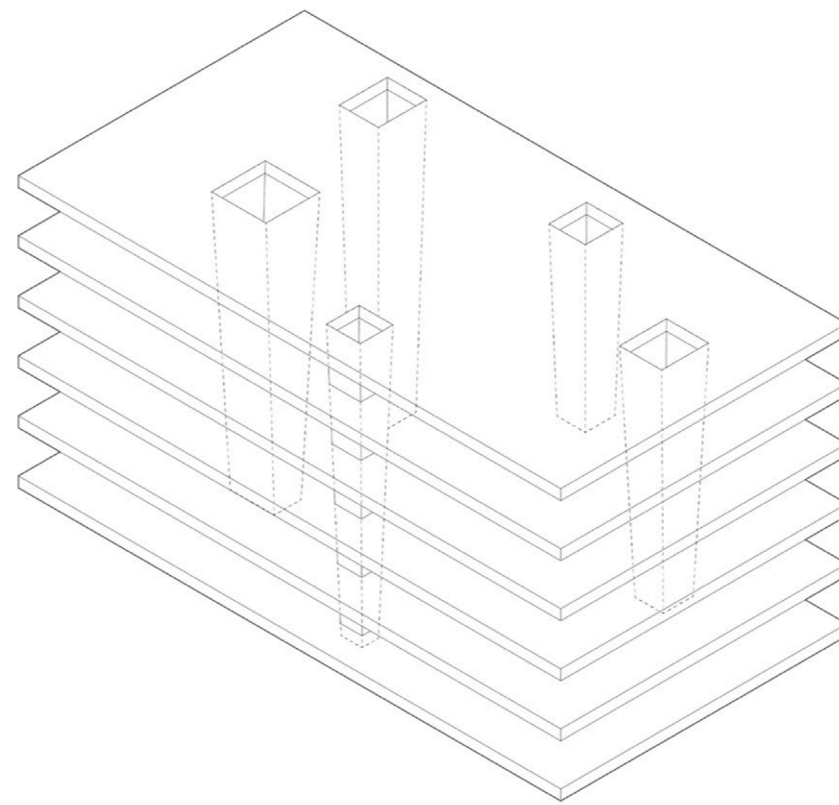
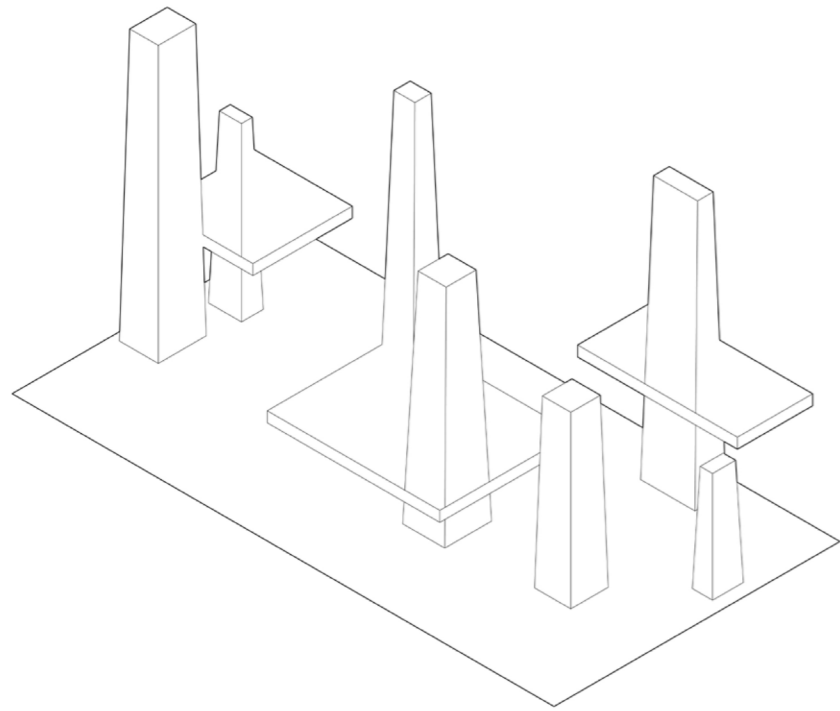
INTERSTITIAL

PUBLIC

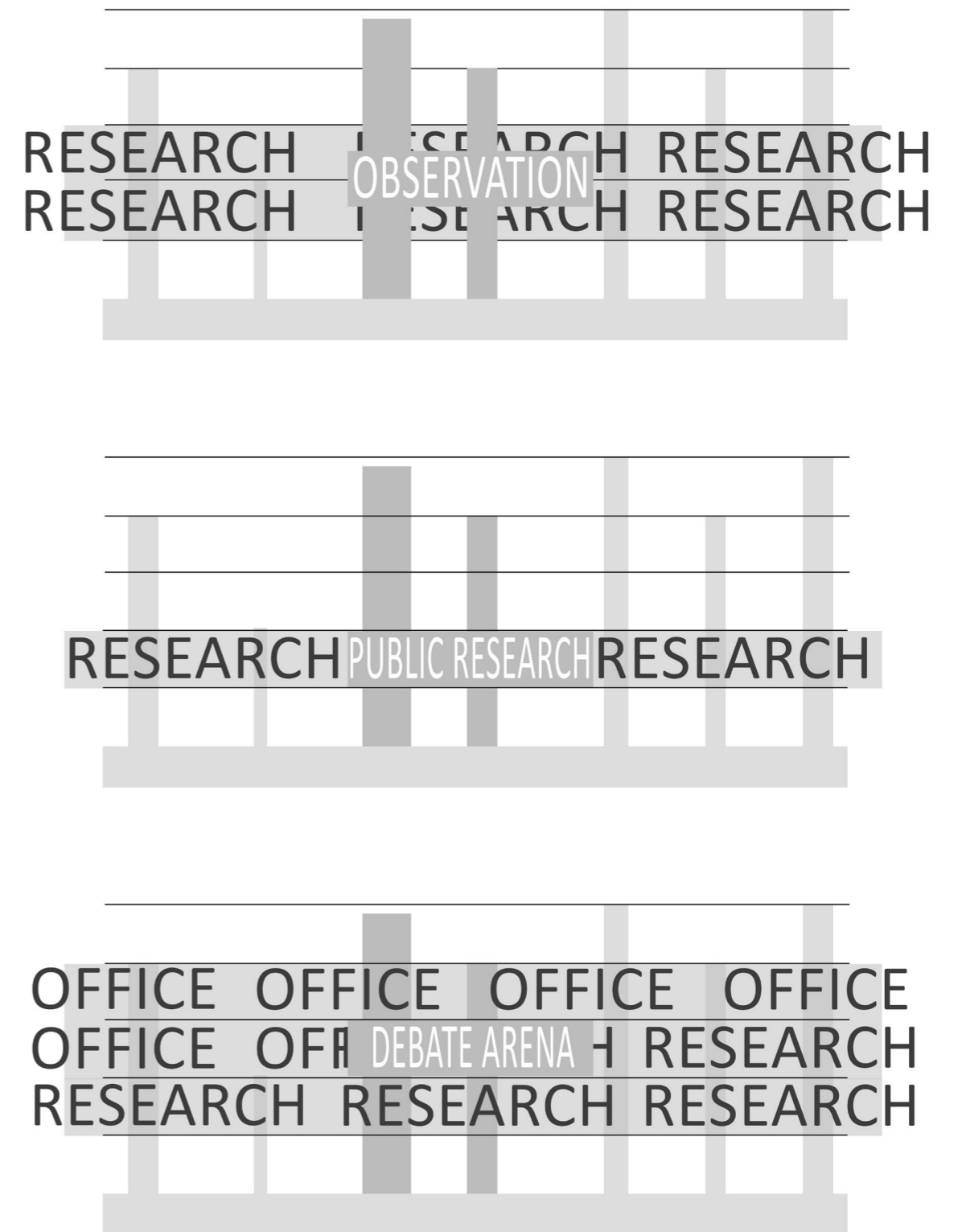


cores - circulation and delivery





idea collage - solving the differentiation between participating and observation state of the public person inside the building

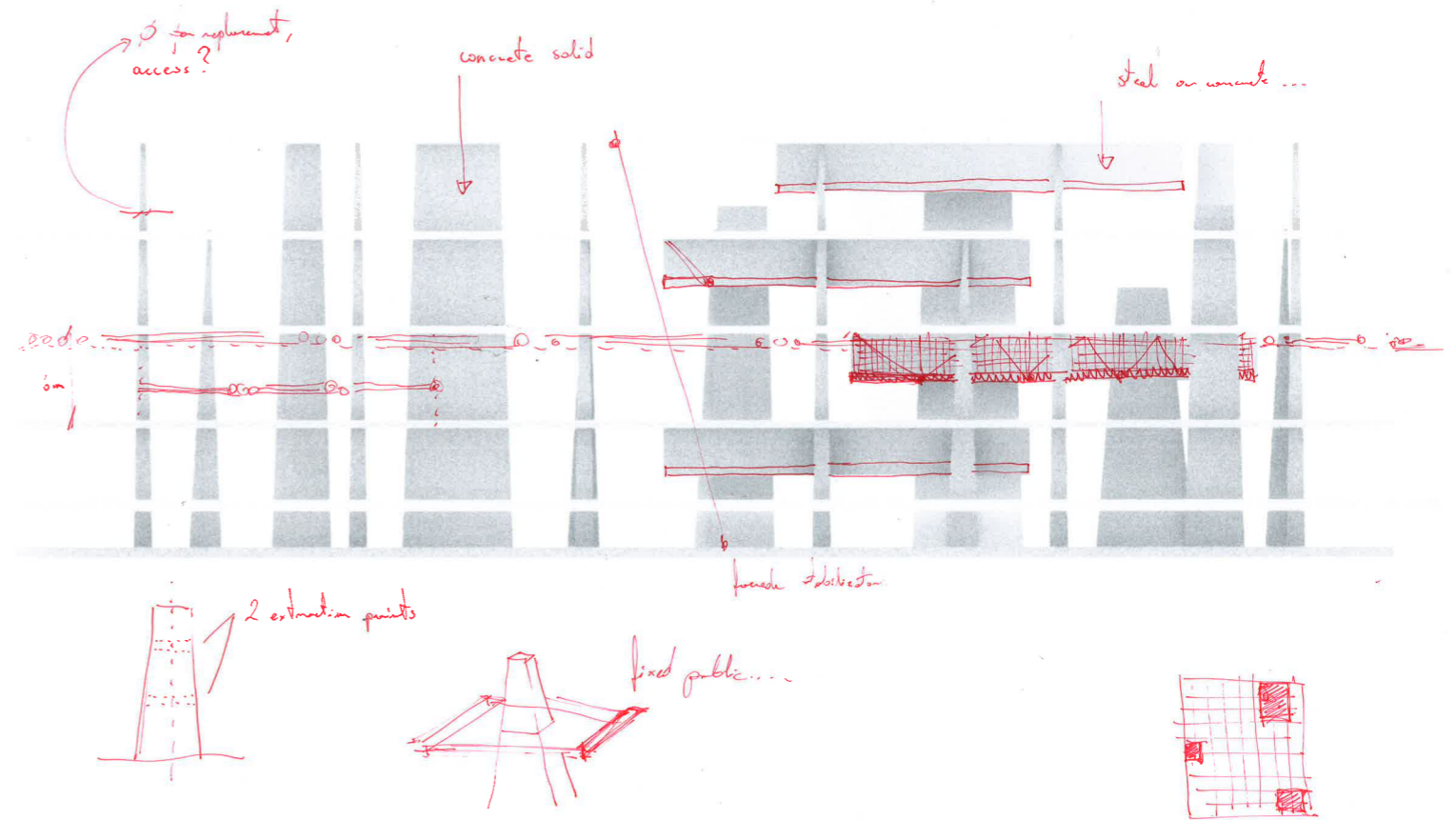


09. INVESTIGATION No. 8

architectural solutions

architectural decisions and solutions reflecting the ambience of scientific world,
technology and architectural quality

study of the materiality in the section drawing,
working with mezzanine floors

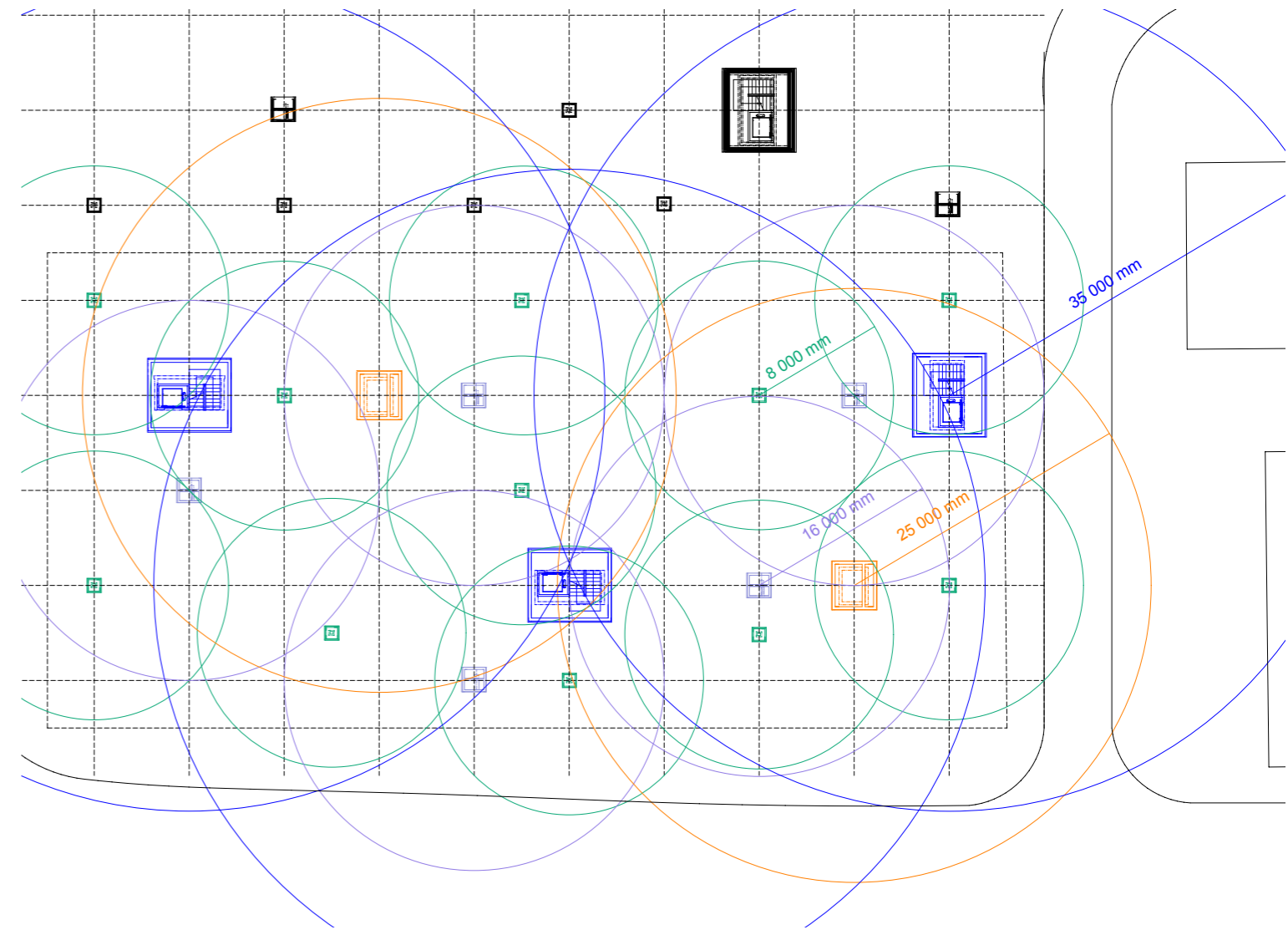


pipng and the system of delivery that provides with the best flexibility possible

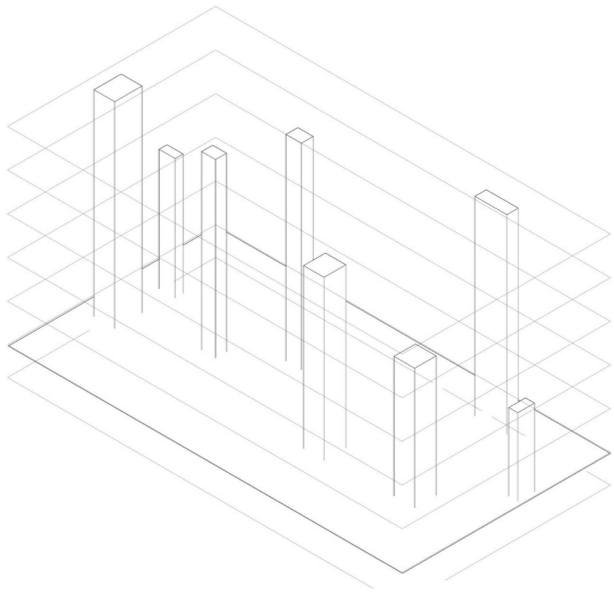
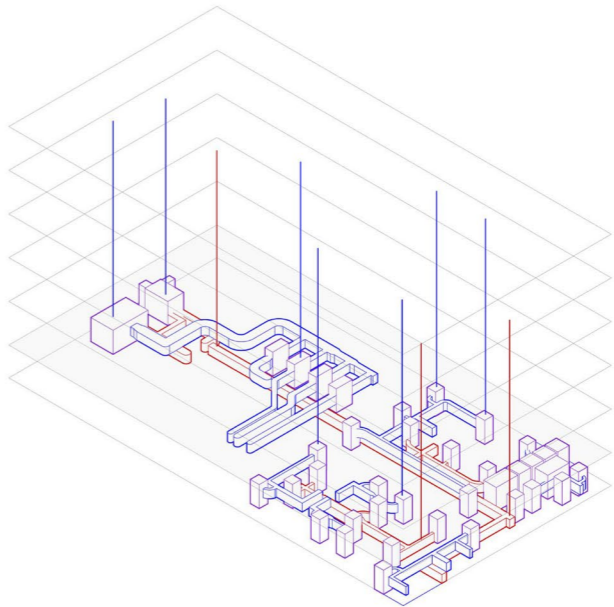
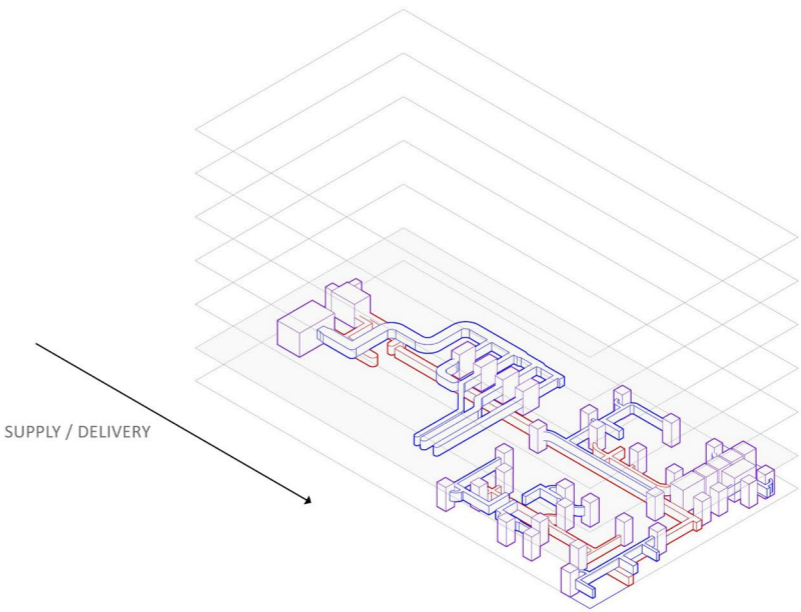


Fig. 71 : piping system, photo: unknown

sketch on the delivery ratio of different cores withing the building



the supply system through the cores - explanatory diagram



the supply system through the cores - explanatory diagram

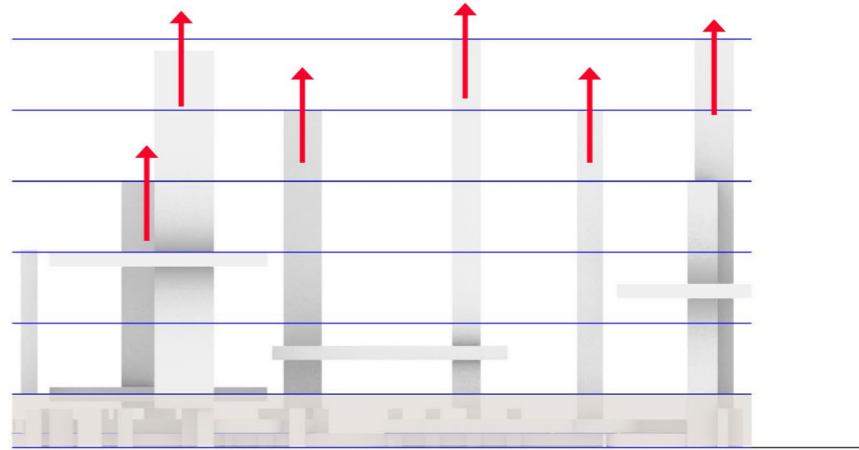
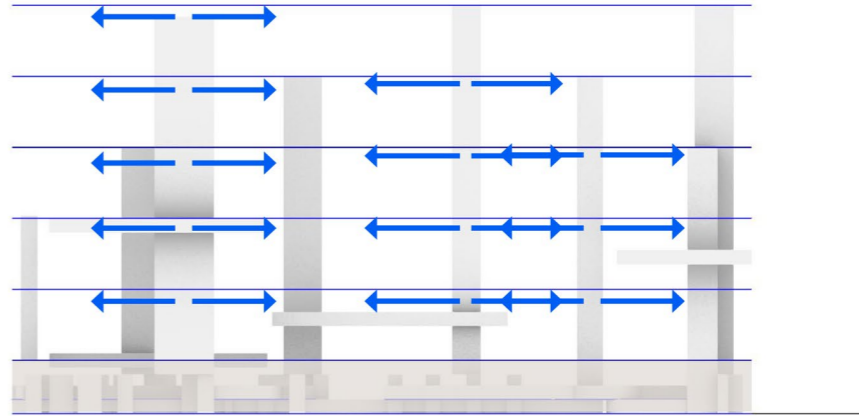
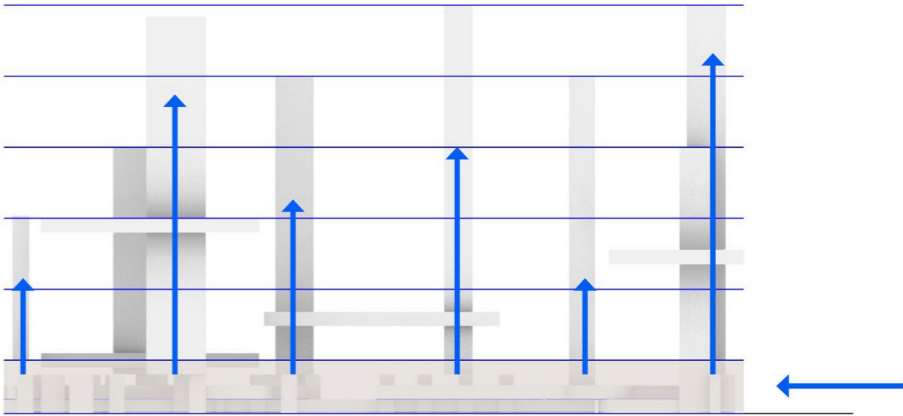


Fig. 74 : supply diagram, drawing: author

the example of a way the system of delivery through the core functions

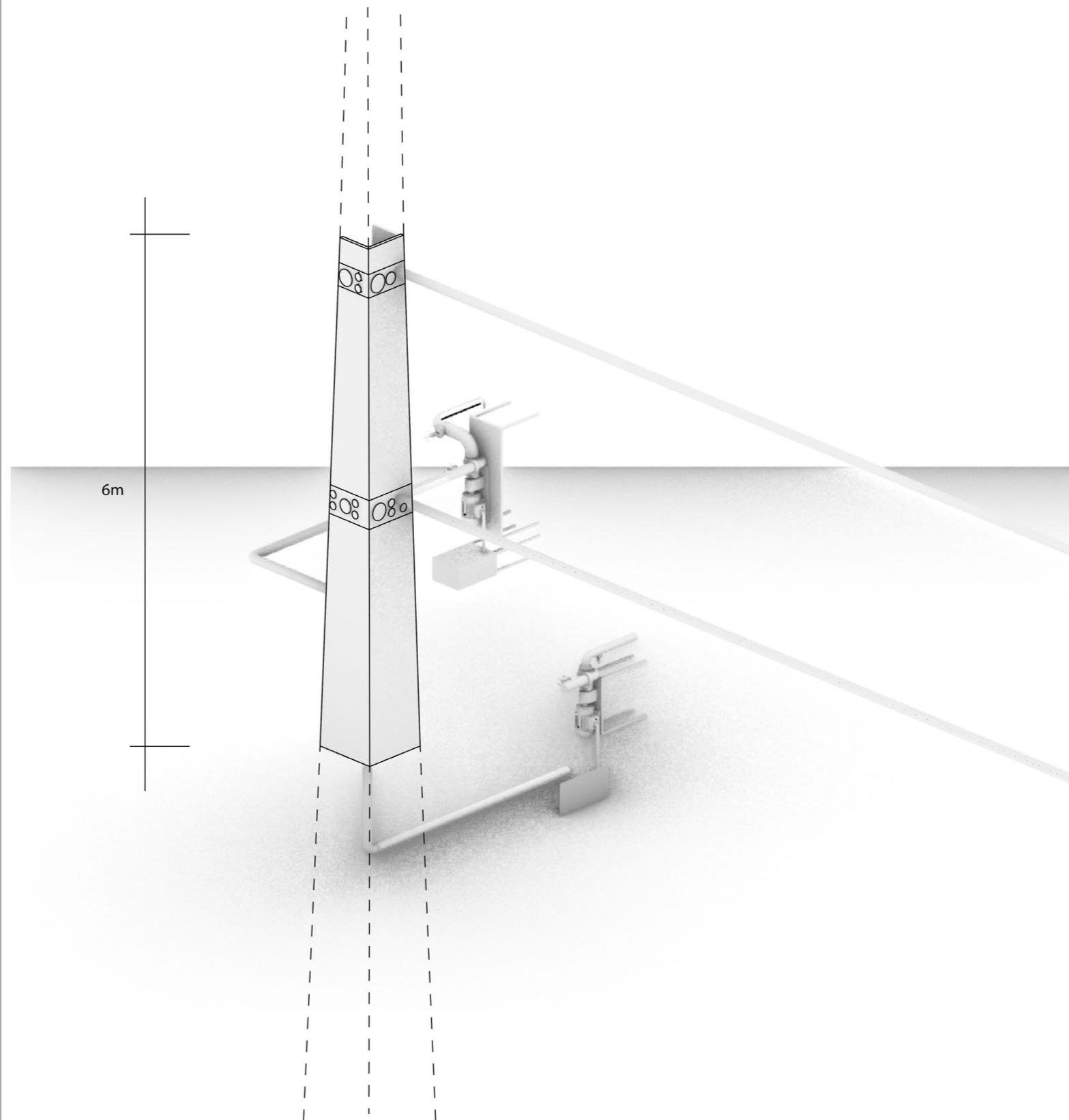
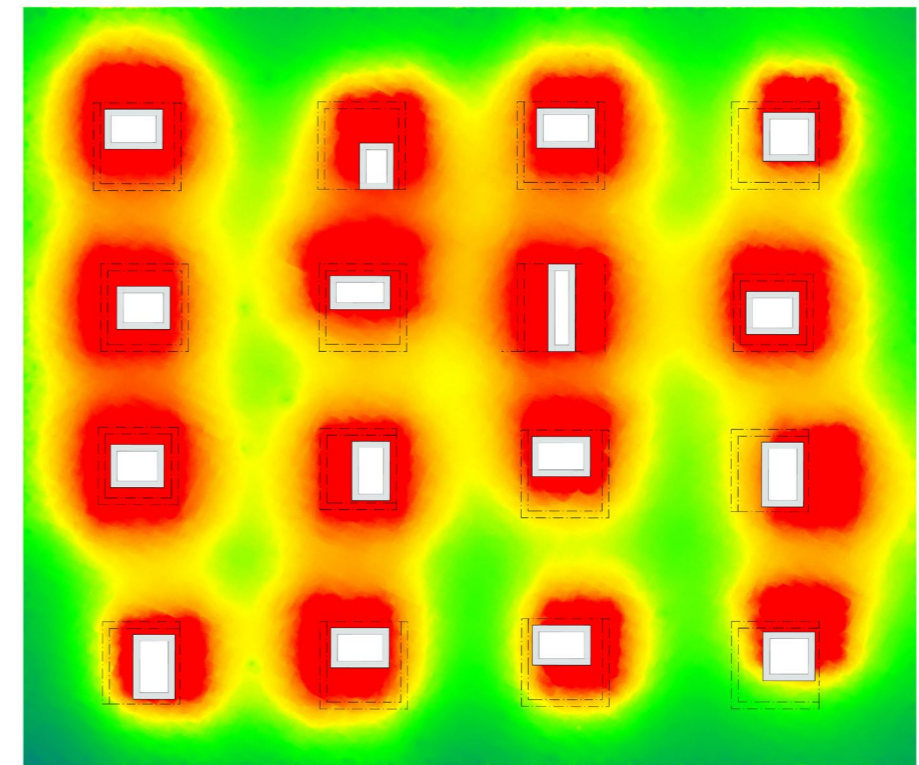


Fig. 75 : detail investigation, drawing: author

the sketch on the light conditions provided by the atriums, simulation



distribution of the cores and different heights they achieve shown in physical model

