

Plan 1, Main entrance

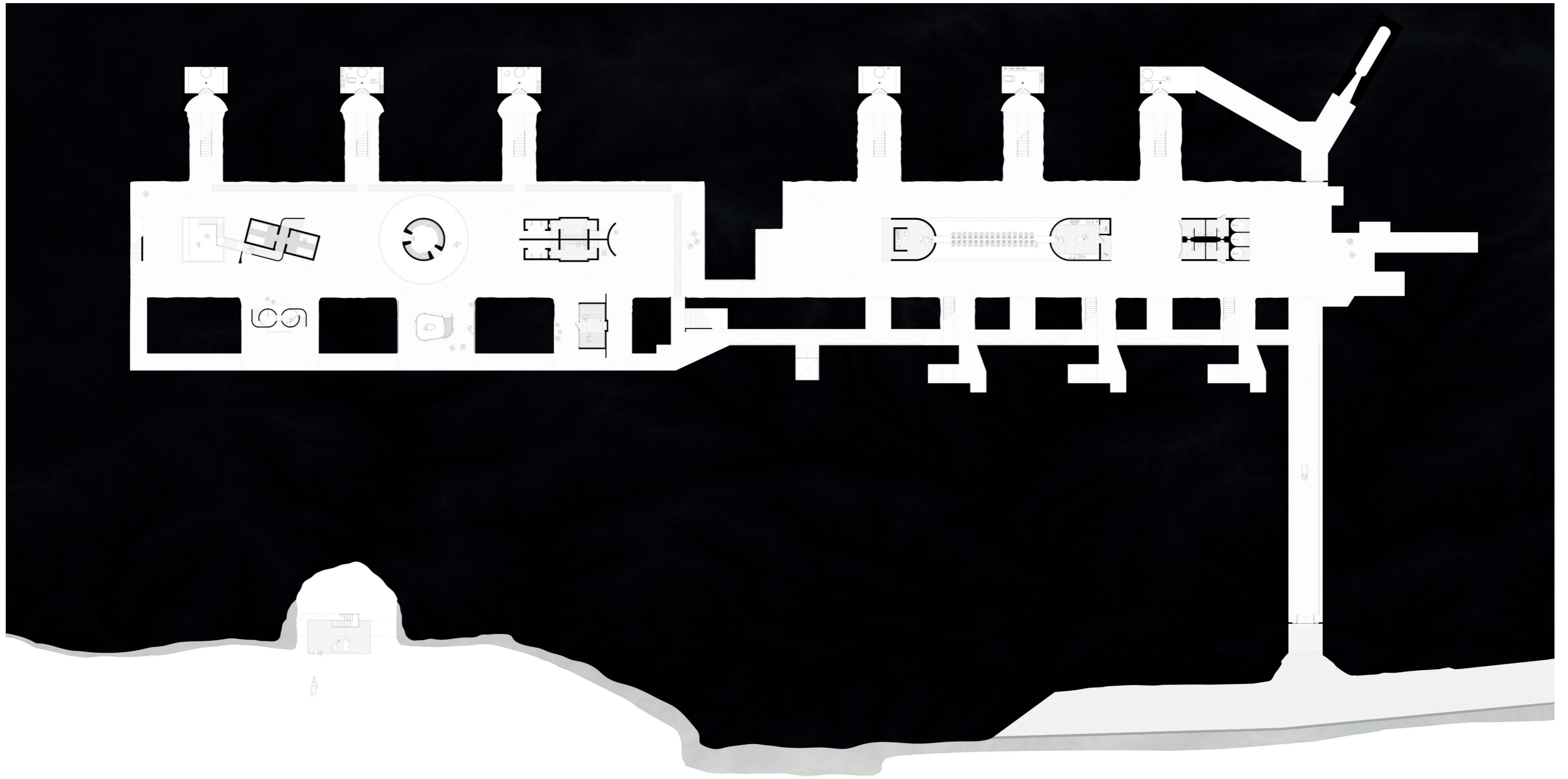

Plan U, Main floor



Section, Long

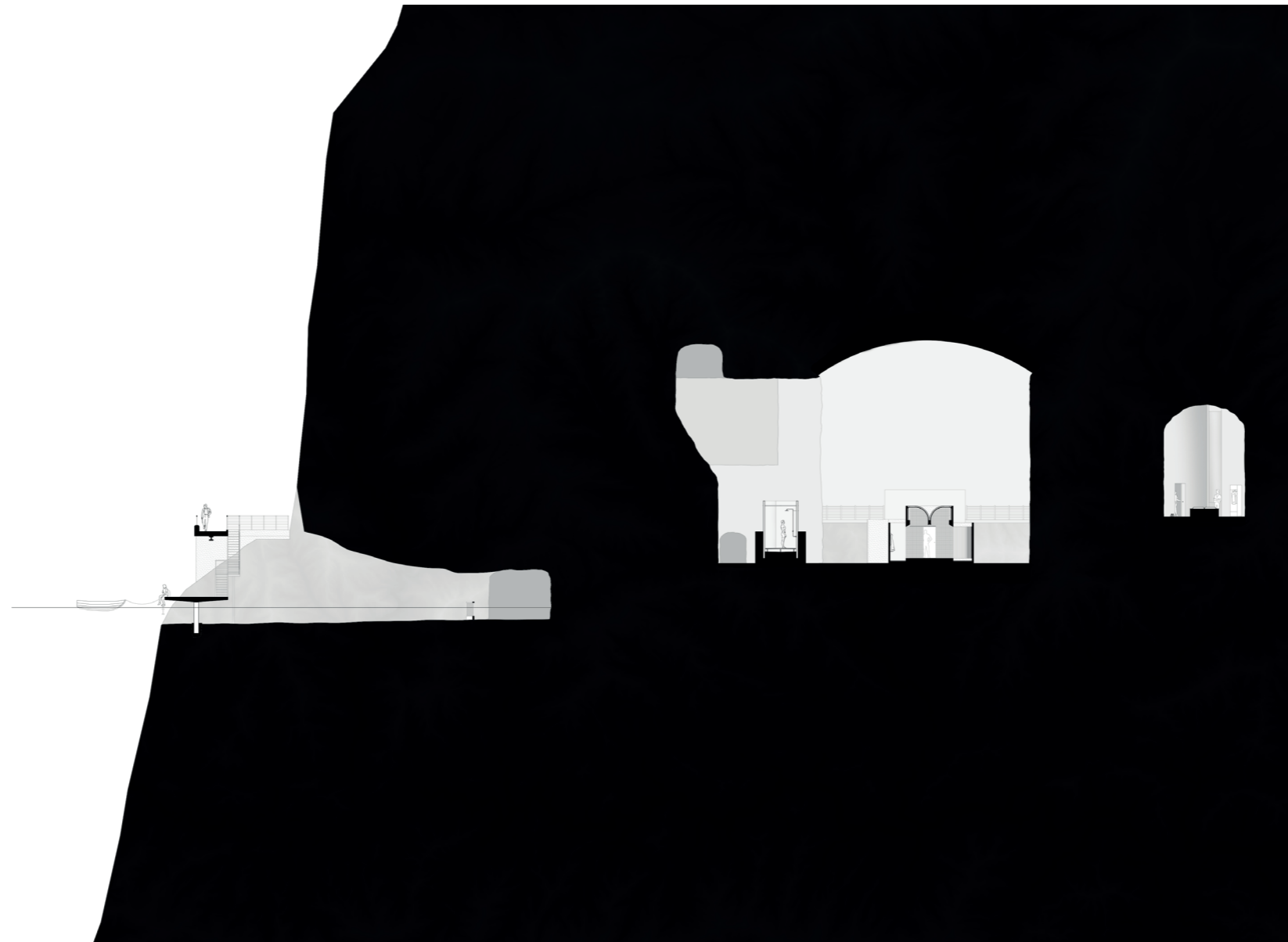

Section, Short

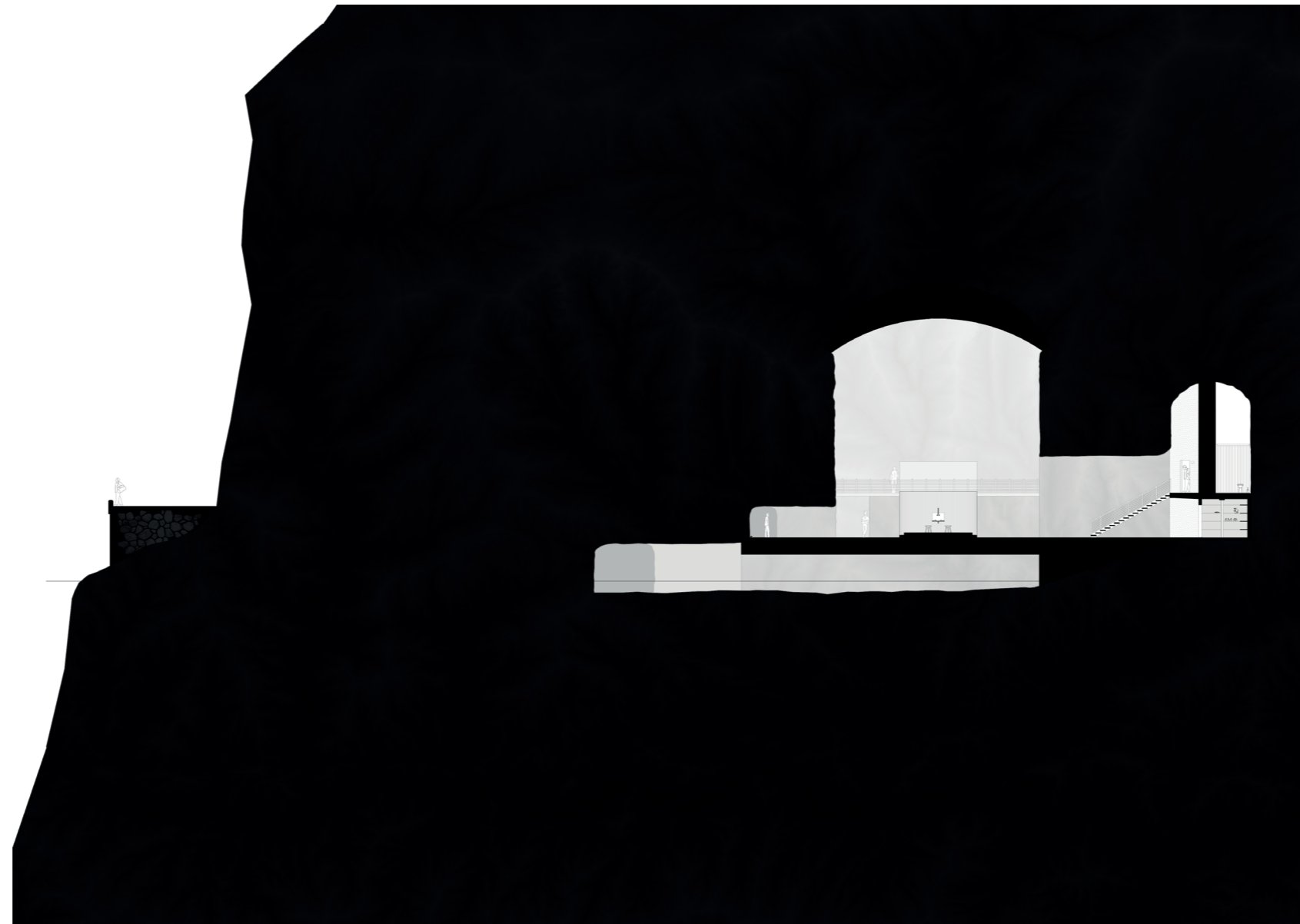

Section, short

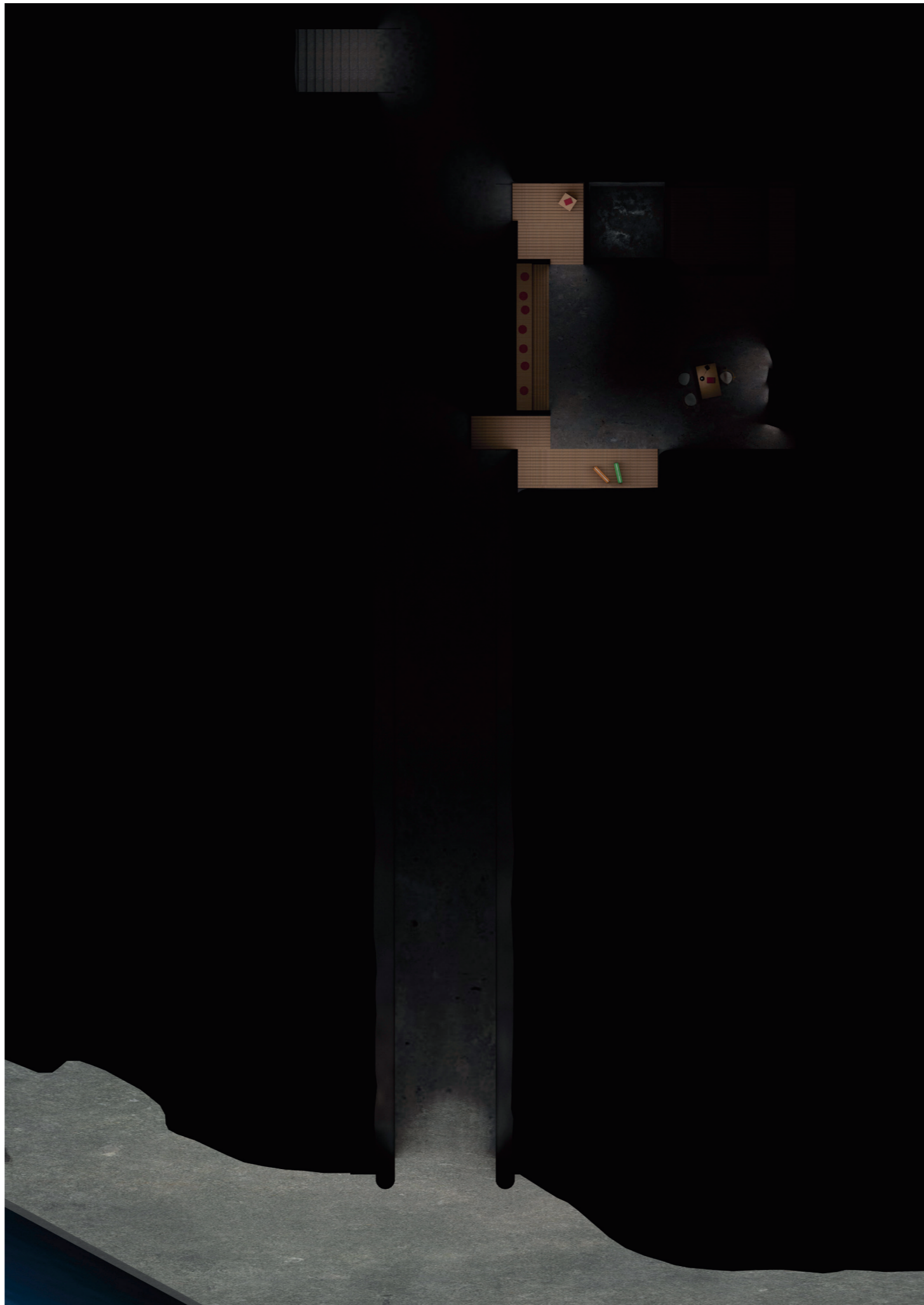

Lightning plan, entrance



Lighting plan, main floor, lights from different functions, how they interact with each other and the dark space around.



Lightning plan, Sleeping area. Moveable furniture to create different and personal space in the dark room.





Lightning plan, Sleeping area. Moveable furniture to create different and personal space in the dark room.



Illustration sleeping 1, showing the concrete wall and the feeling of the room.

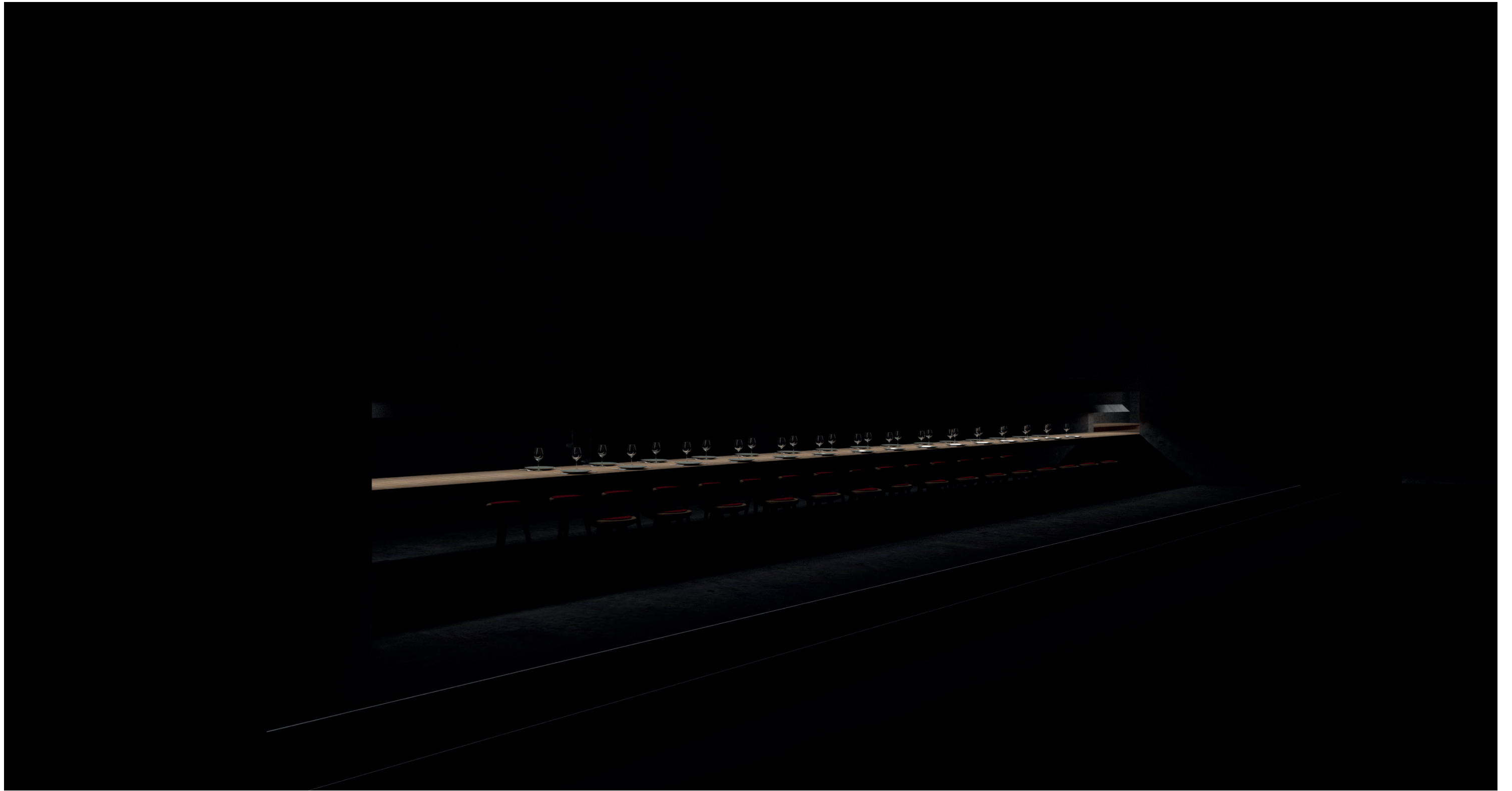

Illustration eating area. Eating in the dark

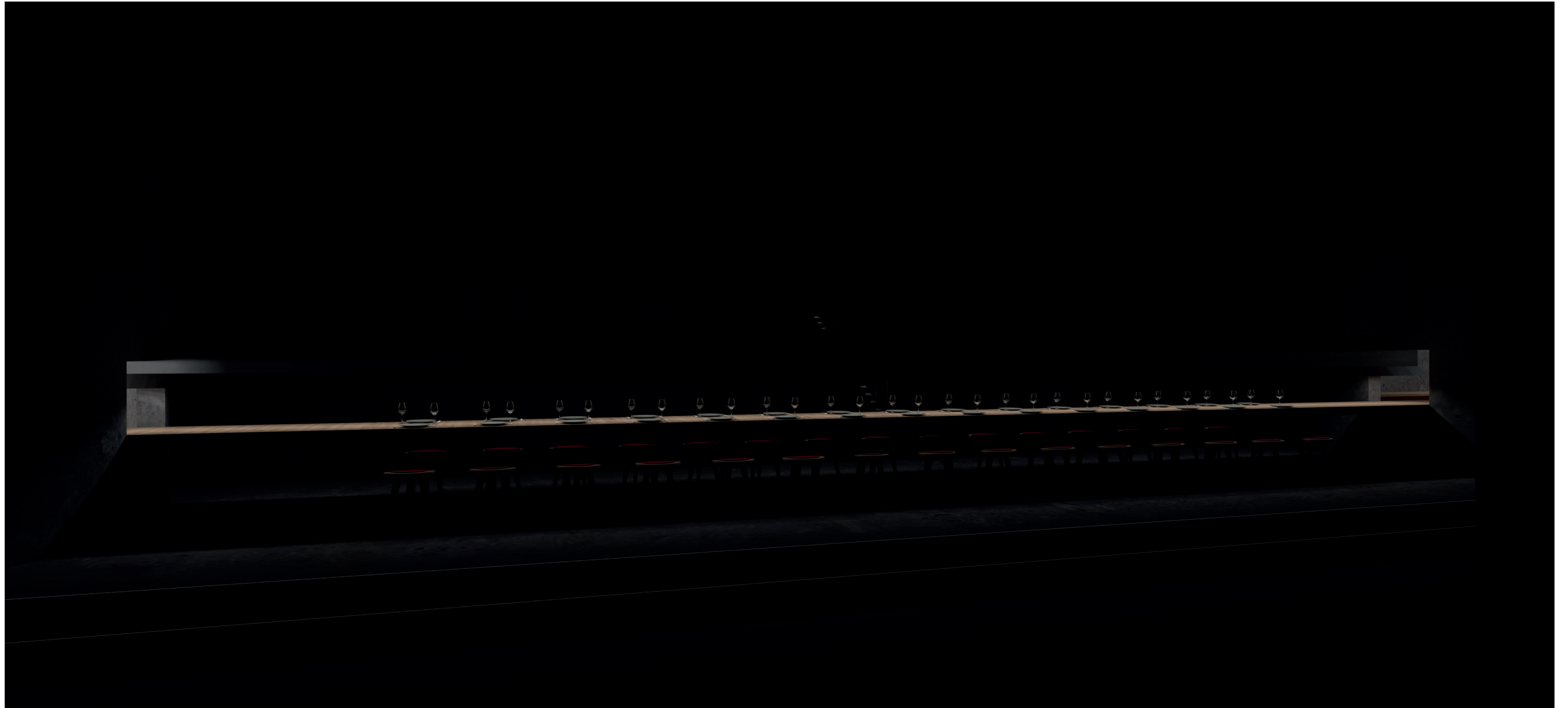

Illustration eating area. Eating in the dark



Section illustration, showing the relation between the light spaces inside of the kitchen/bar and the darkness around the dinnertable.



Illustration inside the bath, showing the shower.

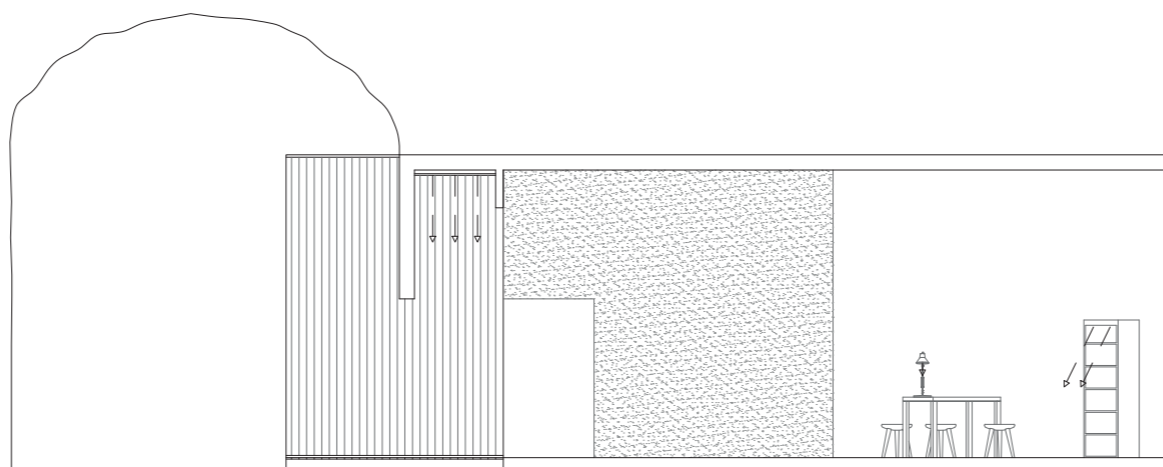
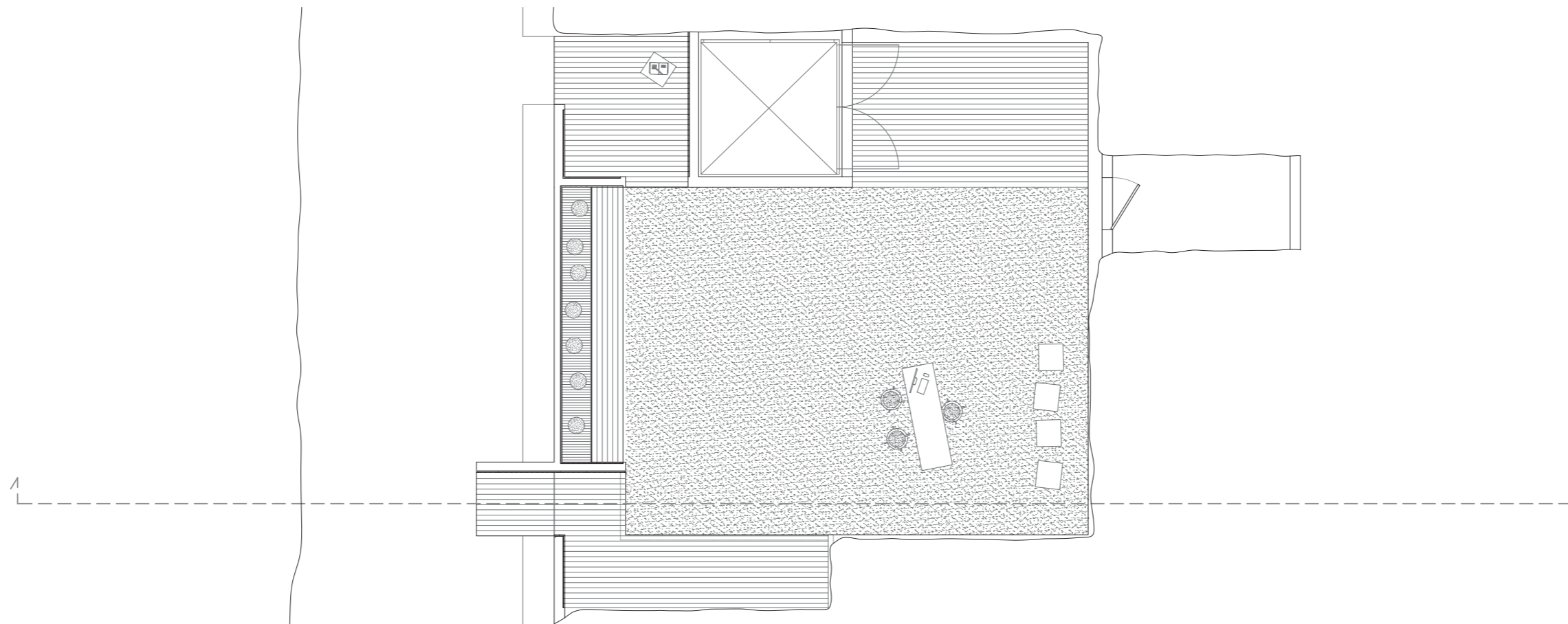

Reception

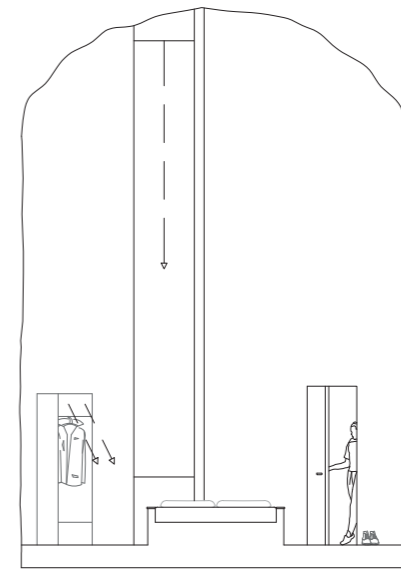
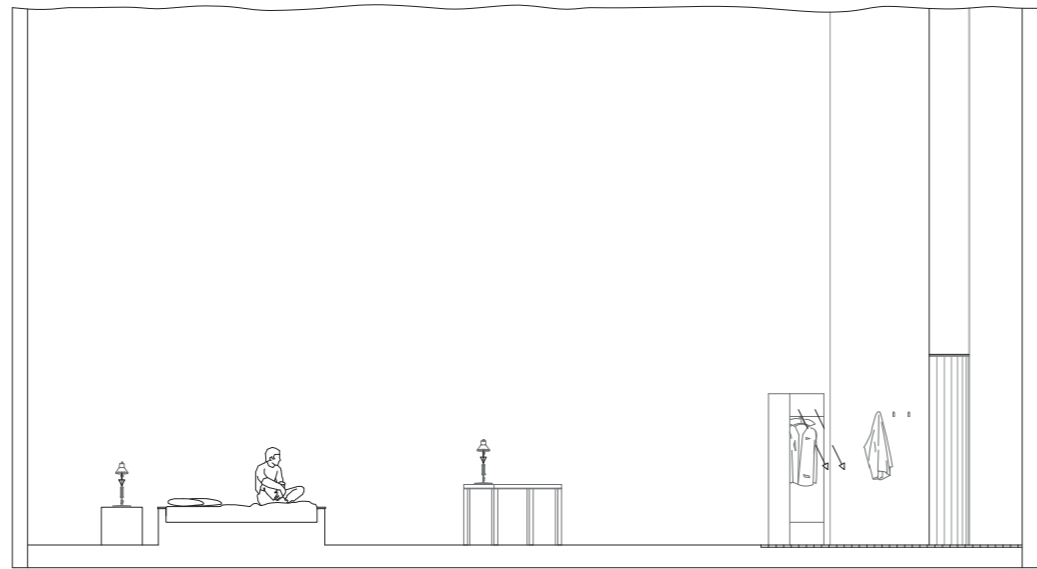
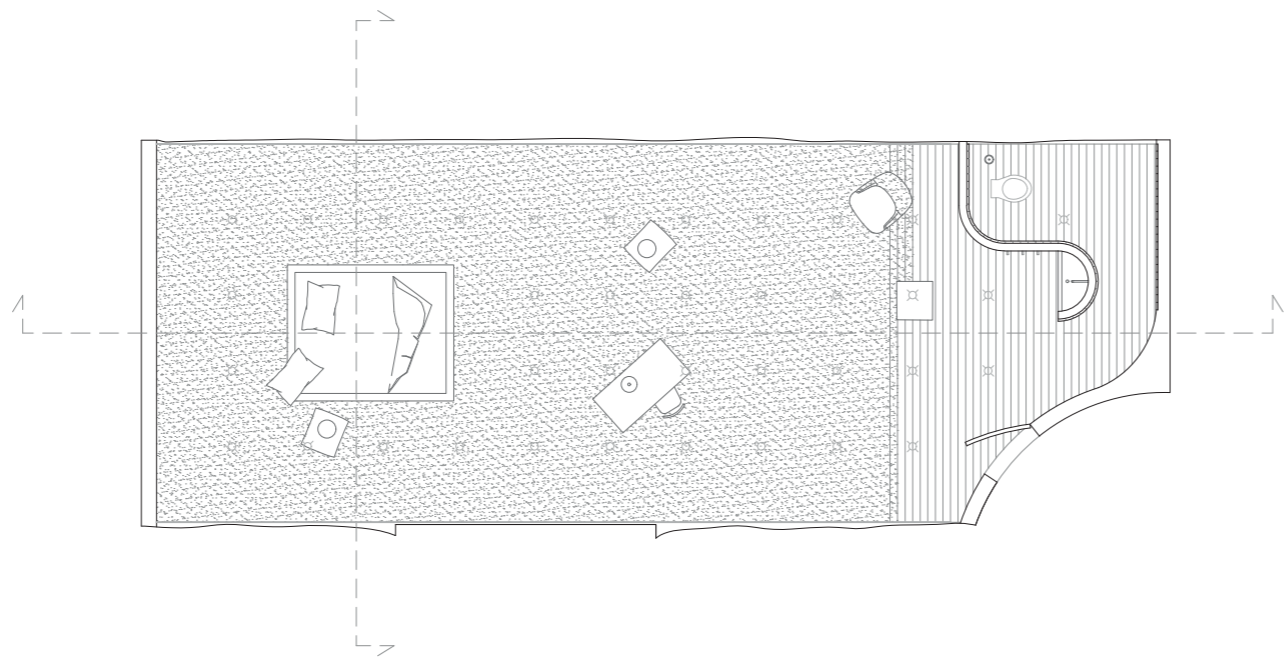

Sleeping 1



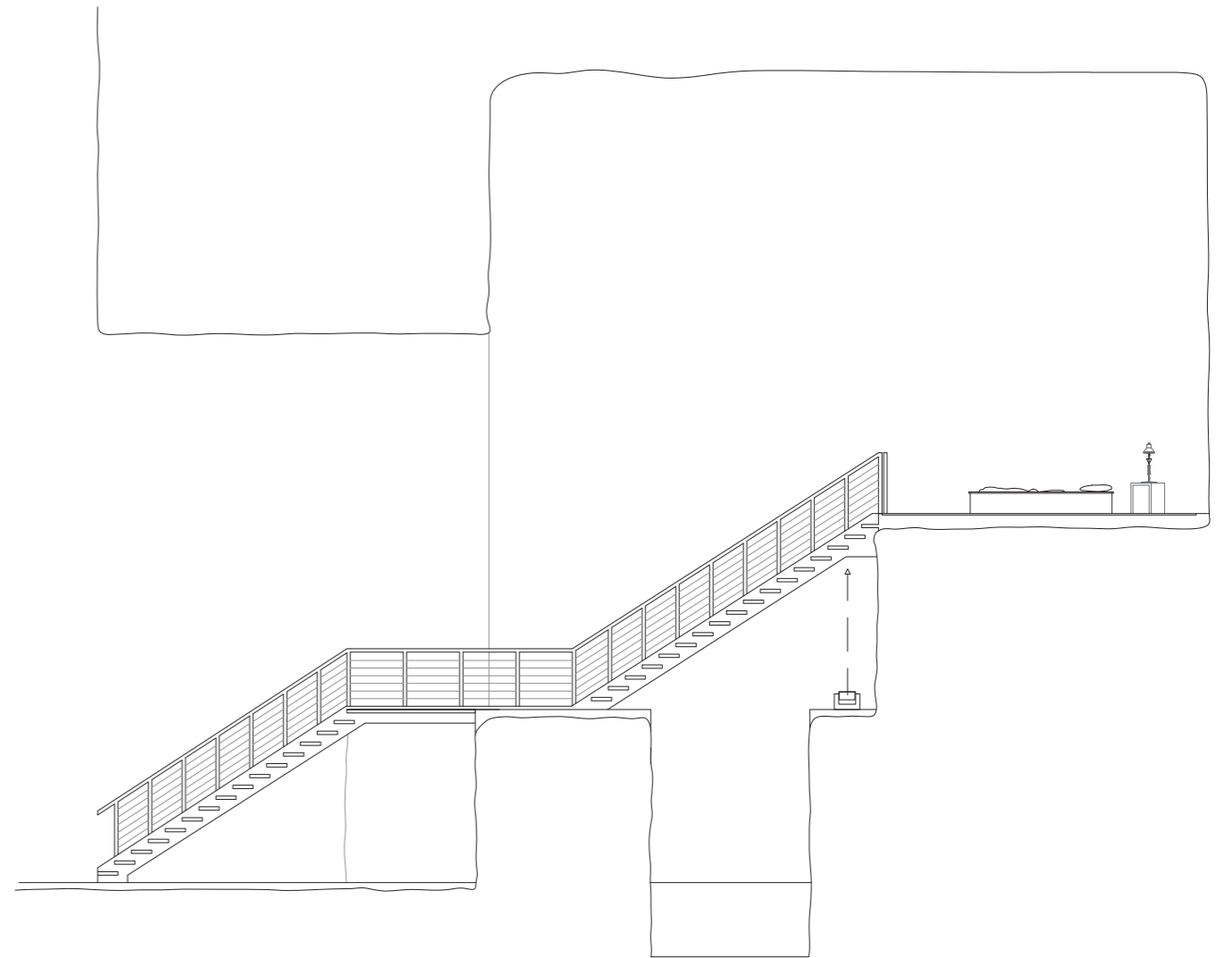
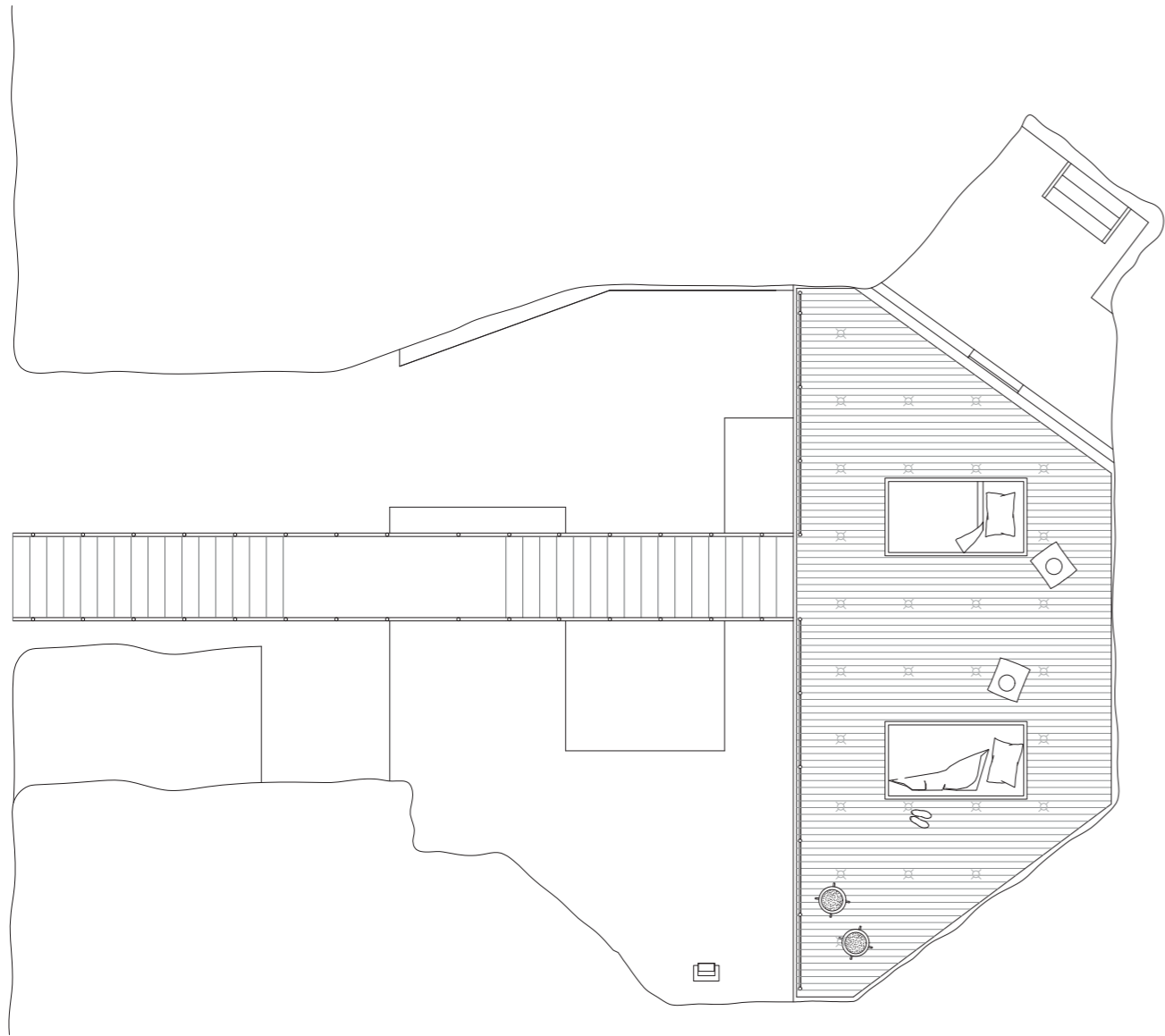

Sleeping 2

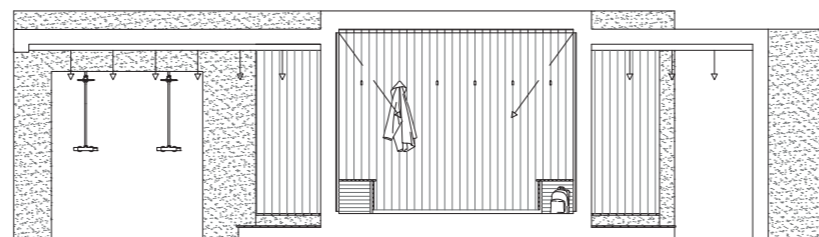
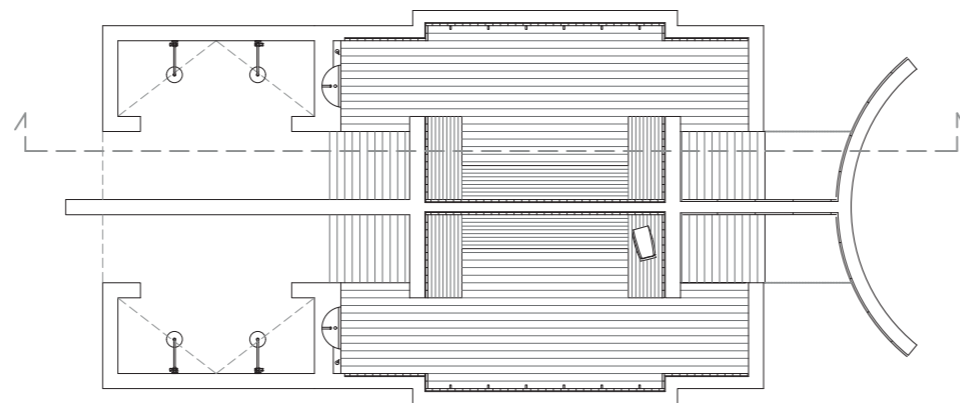

Wardrobe

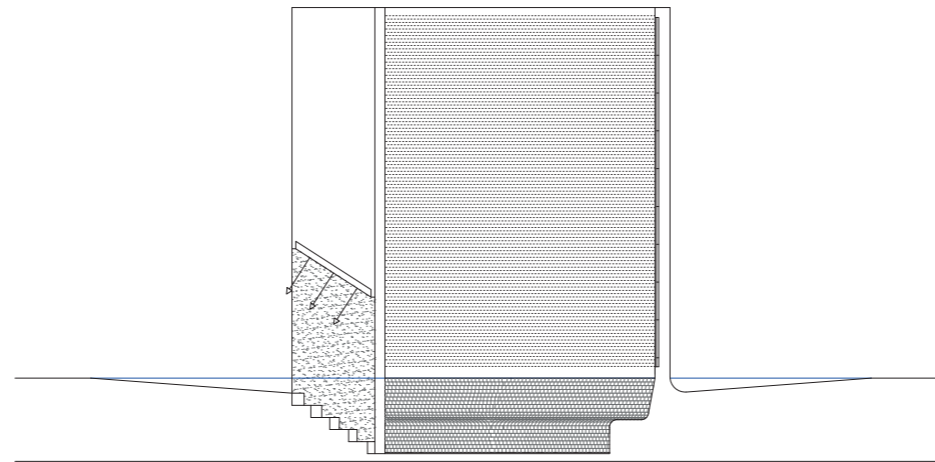
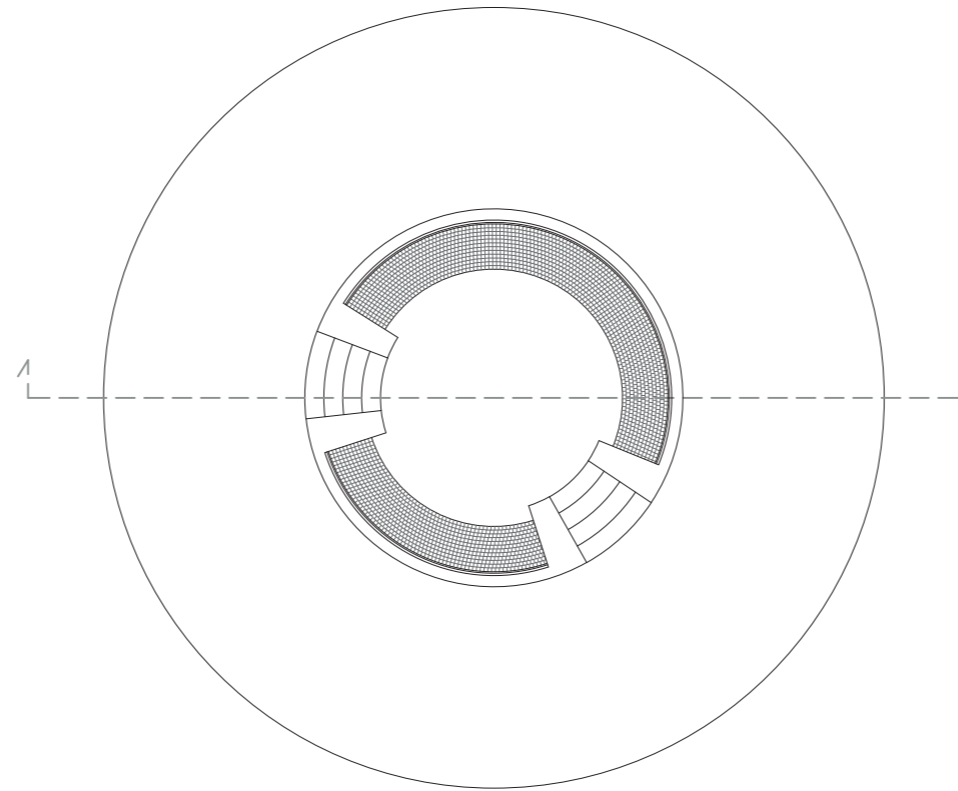

Hot water

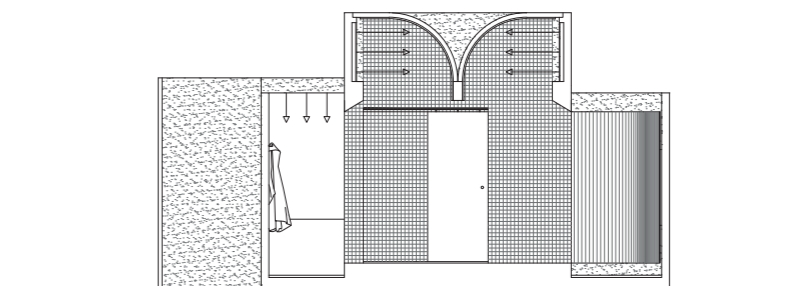
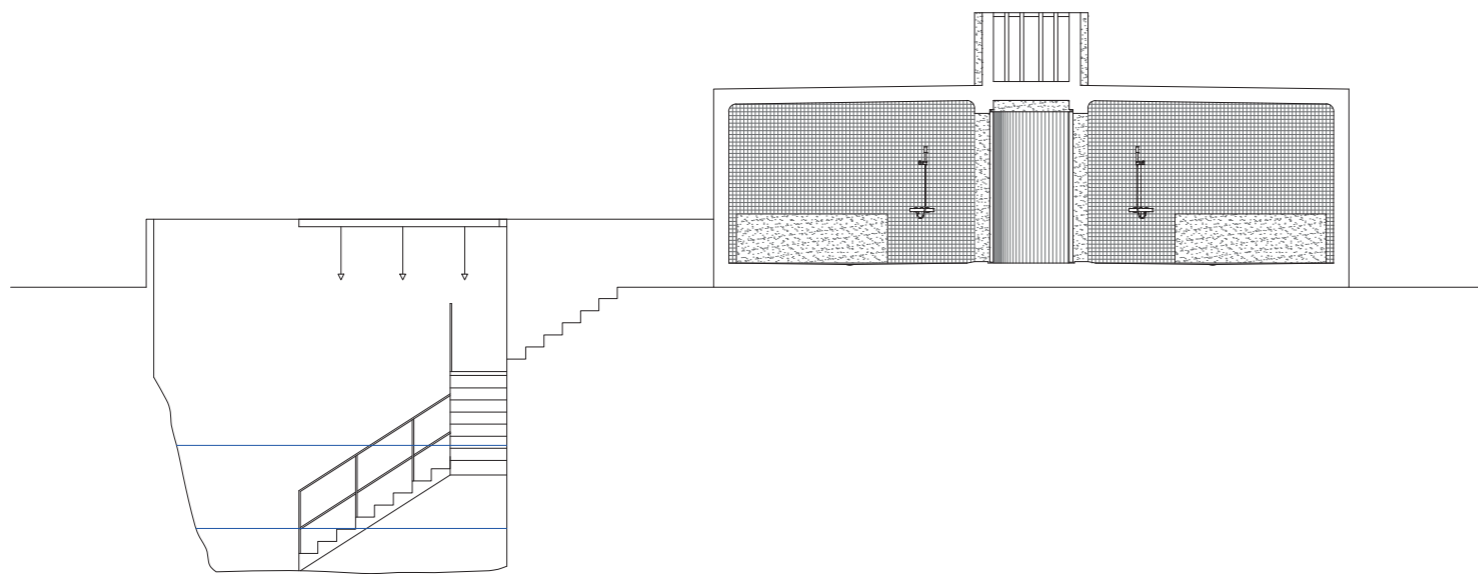
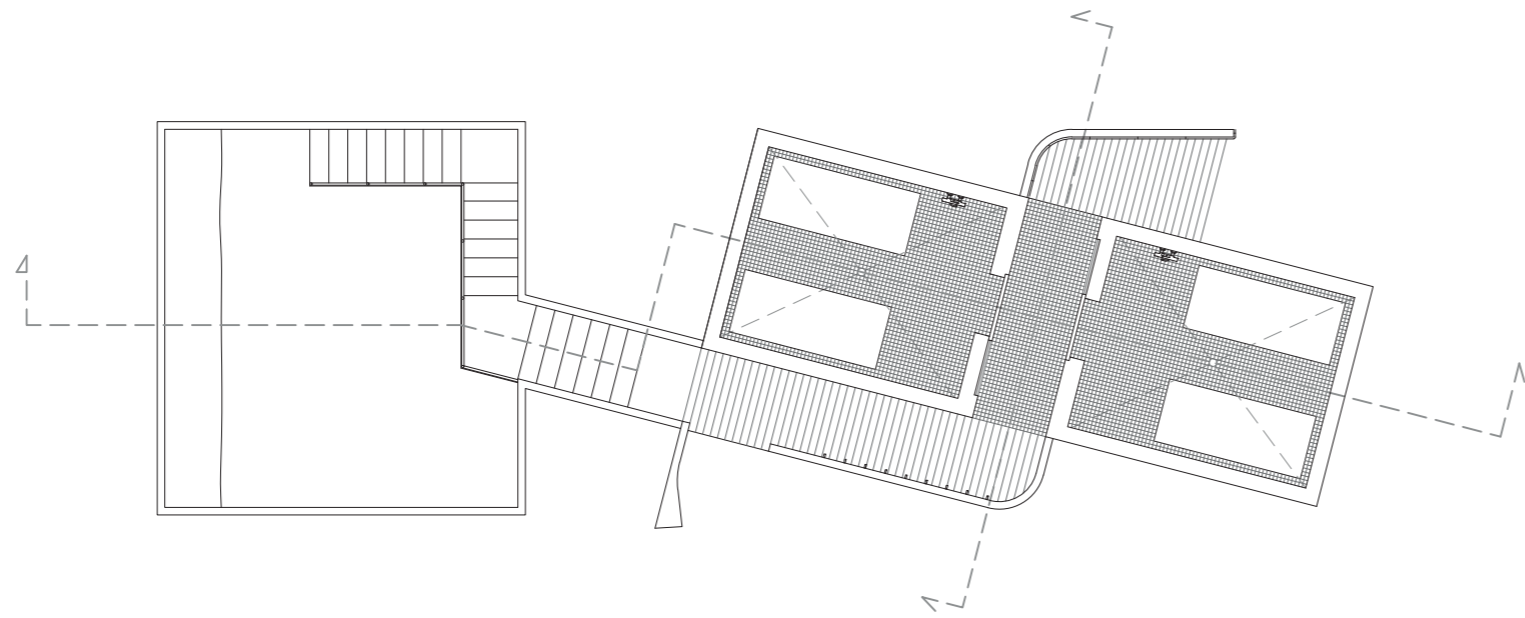

Sweatroom and fjord water

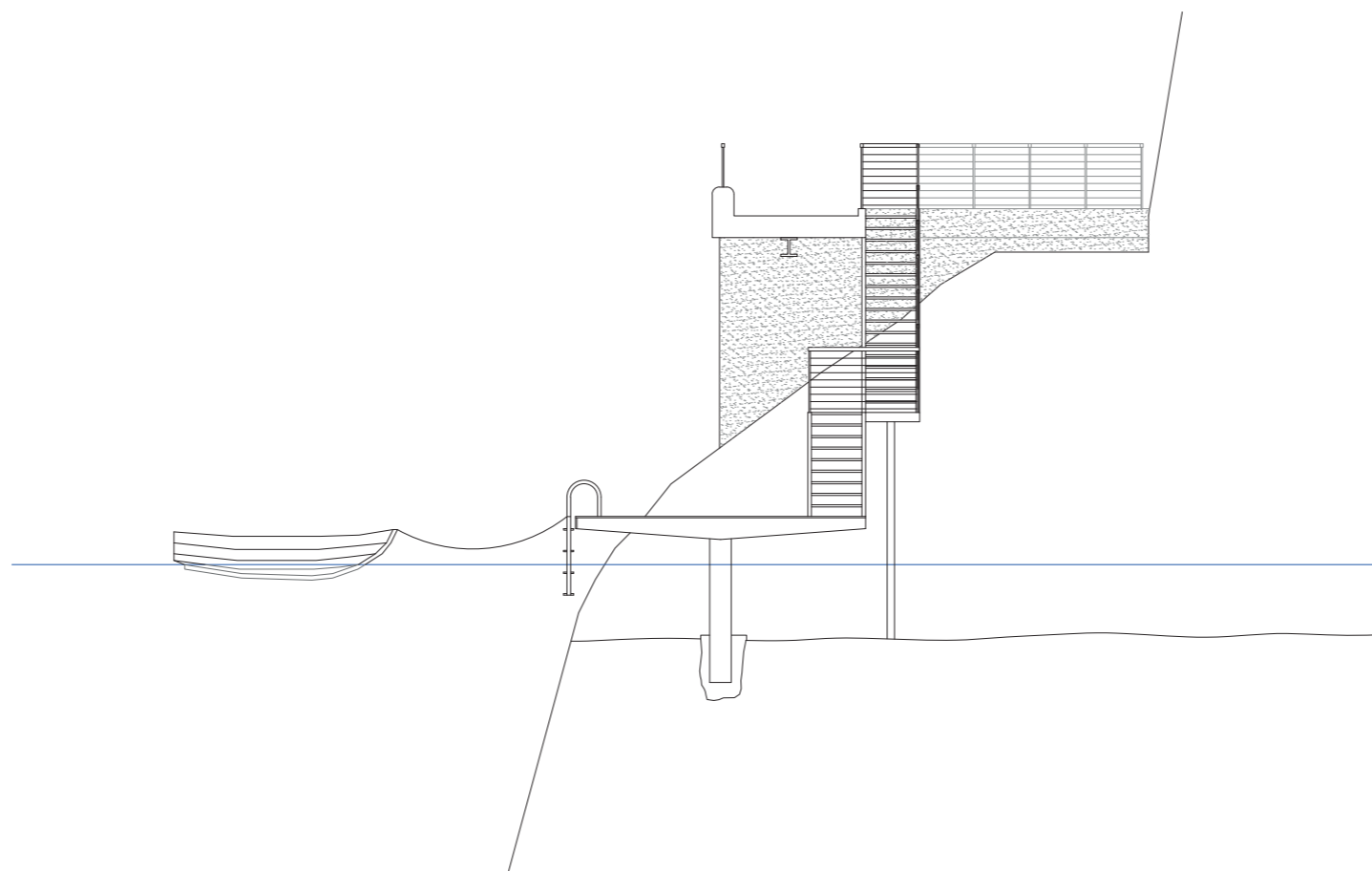
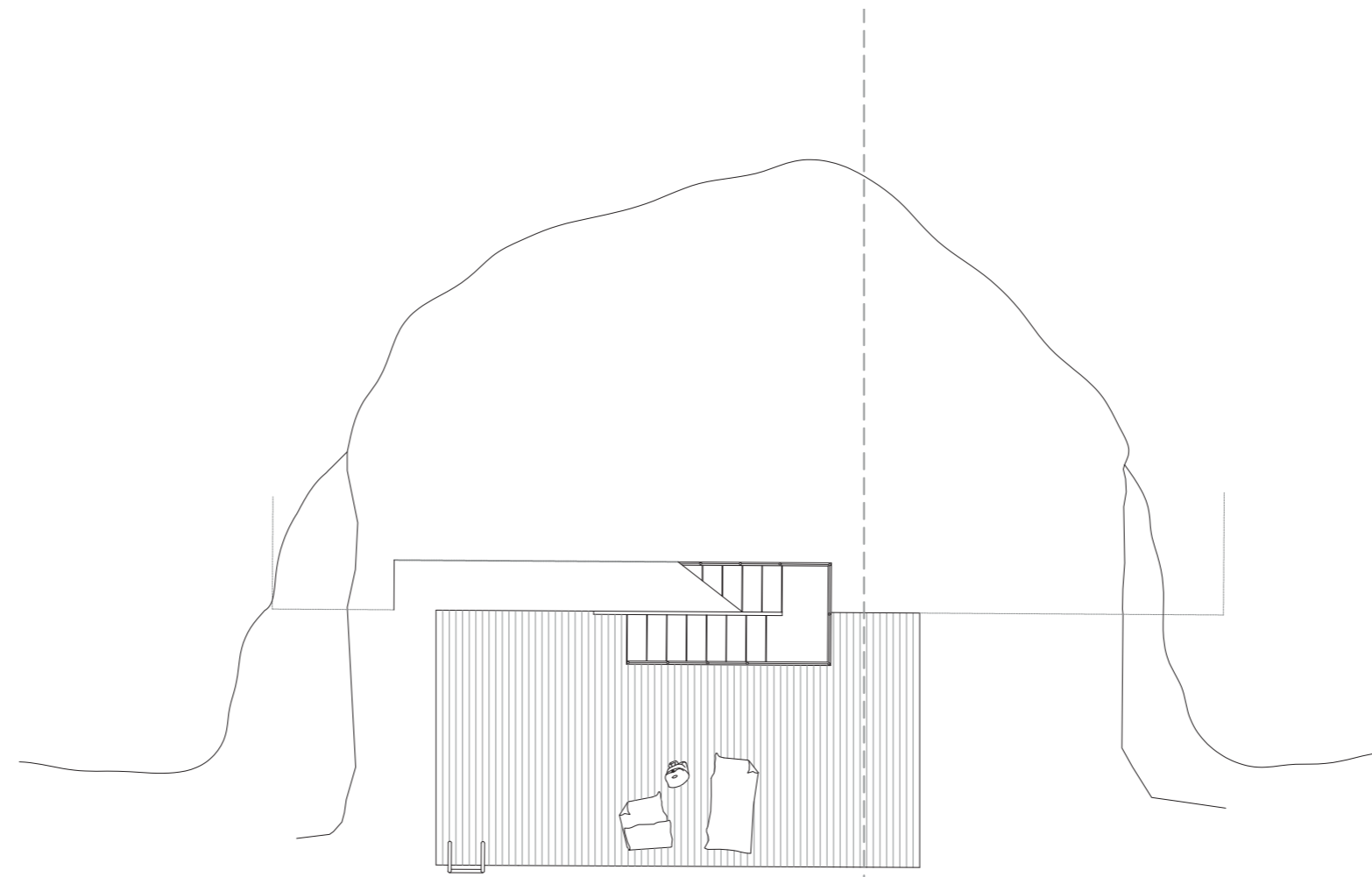

Small pier outside

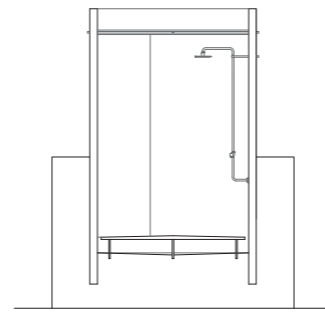
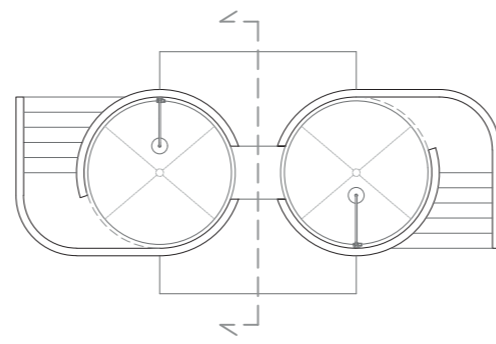

Shower

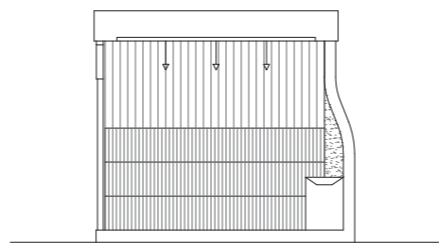
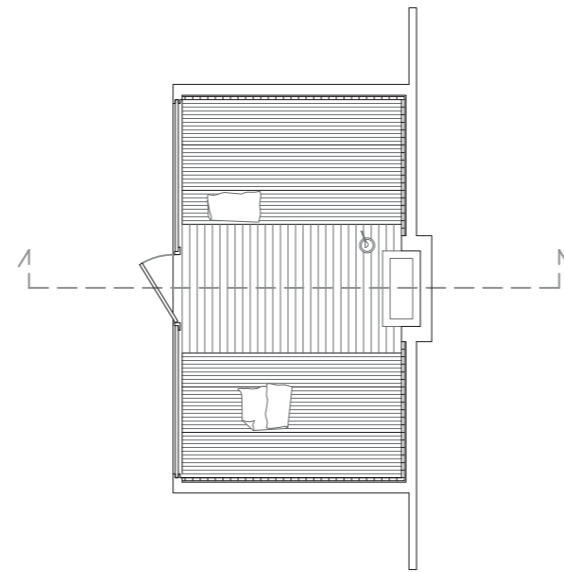

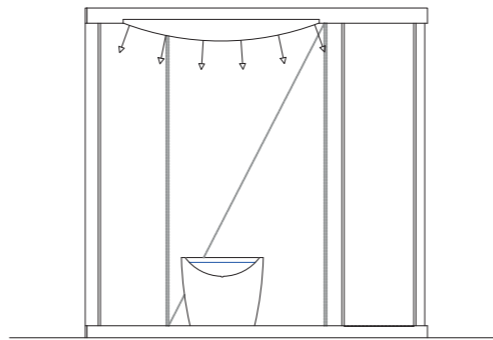
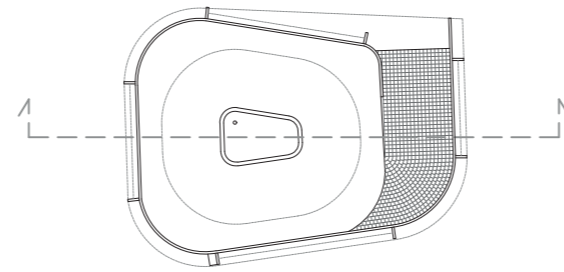

Drinking fountain



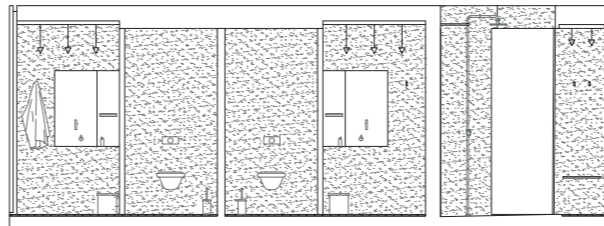
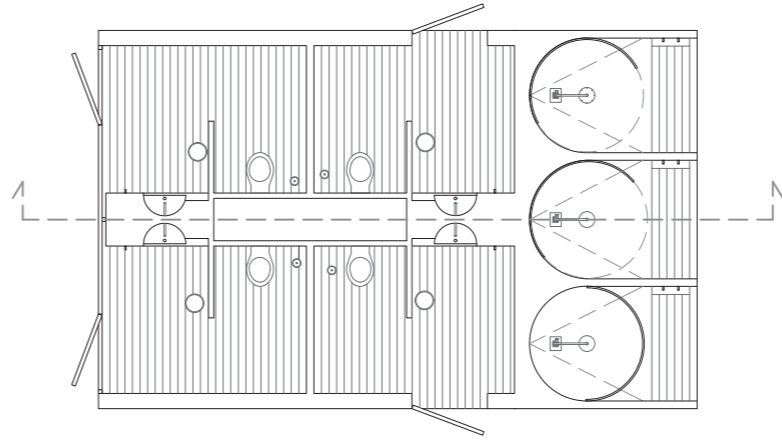

wc and toilet

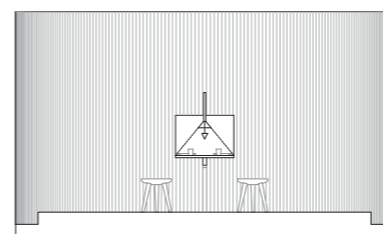
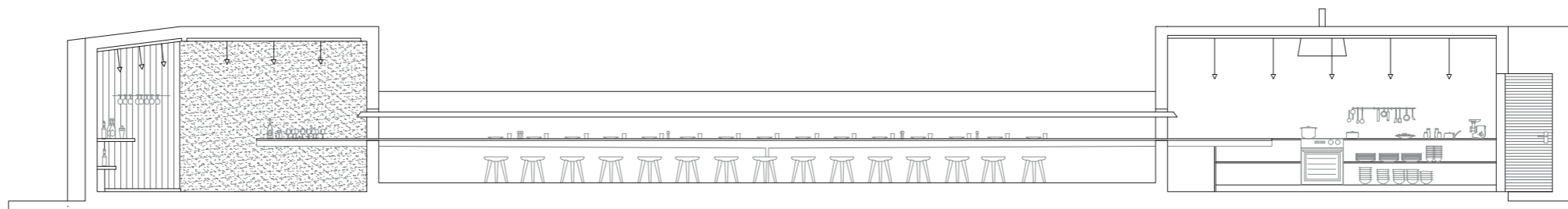
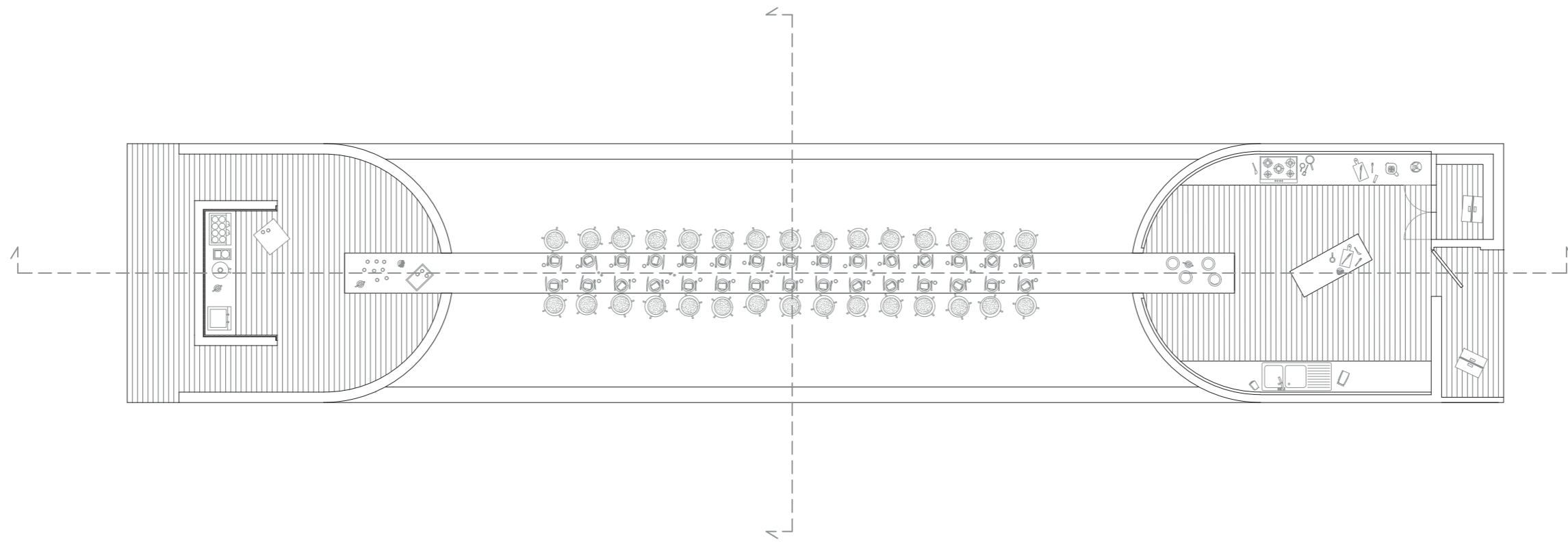

Eating