

DWELLING IN LIGHT - 70° N

Arctic light as generator for new architectural typologies



David Pedersen

Diploma autumn 2023

Supervisor
Lisbeth Funck
Matthew Anderson

External supervisors
Dagur Eggertsson
Lone Sjøli
Christine Fontaine

Institute of Architecture

The Oslo School of Architecture and Design

ABSTRACT

Norway, due to its specific location on Earth, experiences various climatic as well as topographic challenges that architecture has had to face over time in order to cope with its harsh surroundings. In addition, the Arctic region of Norway has to face irregularities in daylight distribution throughout the year, phenomena called polar days and polar nights. As I have been traveling to Northern-Norway, exploring cities such as Tromsø, Bodø, Vardø, and other smaller villages in the county of Troms & Finnmark, I have experienced architecture that is oddly similar to the one we find in Southern-Norway. The shape of a single-family house, its materials, the quantity of windows and its size speak more or less the same language.

Tromsø, located at approximately 70° North, has more sunhours (around 4541 hours) above the horizon during a year comparing to Oslo (around 4441 hours) at 50° North. Despite that being a fact, it is strictly related to a mathematical calculation. It is, rather, the distribution of these hours and the light conditions they create that should be of interest. Light phenomena that occur in Northern-Norway play an important role in everyday life for the inhabitants that live there, which happens to be one of the biggest accumulations of people living above the Arctic Circle on Earth. In the summer, you can experience the midnightsun while, on the contrary, in winter, the sun never rises above the horizon for some weeks, creating extended sunrise and sunset colors in the sky as it approaches from the south for a few hours of the day. Dwelling in Light - 70° N aims to address thematic irregularities in daylight distribution in single-family house typologies in Arctic Norway, with Tromsø as a reference point. Through my investigation, I wish to learn from the locals, professionals, case studies, history, and a more analog approach to light using a method developed during my pre-diploma semester.

That will hopefully raise new questions and contribute to a better understanding and exploration of the light conditions this region offers on a daily basis, creating an architecture generated by this region by implementing the surroundings in the shell we call our home.

BACKGROUND



SINGLE-FAMILY HOUSE
SOUTHERN NORWAY



SINGLE-FAMILY HOUSE
NORTHERN NORWAY

CONTENTS

1. INTRODUCTION TO ARCTIC & TROMSØ

1.1 - Arctic	10
1.2 - Arctic circle - Norway	11
1.3 - Inhabitants	12
1.4 - Tromsø	13 - 14
1.5 - Light conditions	15 - 16
1.6 - Pictures of Tromsø	17 - 26
1.7 - Sources	27

2. INTRODUCTION TO THE THEME - RESEARCH

2.1 - Research question/s	29 - 30
2.2 - Methods	31
2.3 - Heliodon 1 - process	32 - 55
2.4 - Heliodon 2 - process	56 - 57
2.5 - Interview locals - statistics	58 - 73
2.6 - Interview professionals & history	74 - 76
2.7 - Case studies	77 - 90
2.8 - Sources	91 - 92

3. DEVELOPING THE CONCEPT

3.1 - Program	96 - 97
3.2 - Sun studies - Heliodon 1	98 - 121
3.3 - Sketches - process	122 - 201

4. FINAL PROJECT

4.1 - Project description & Program	204 - 205
4.2 - Diagrams	206 - 213
4.3 - Construction	214 - 218
4.4 - Section - Imaginary life	219
4.5 - Plans	220 - 223
4.6 - Specific site	224 - 225
4.7 - Interior photos of 1:20 model	226 - 245
4.8 - Painting	246 - 247
4.9 - Acknowledgements	248
4.10 - Dedication	249

Unless stated in the binder, all illustrations are by the author

1. INTRODUCTION TO ARCTIC & TROMSØ

- 1.1 - Arctic
- 1.2 - Arctic circle - Norway
- 1.3 - Inhabitants
- 1.4 - Tromsø
- 1.5 - Light conditions
- 1.6 - Pictures of Tromsø
- 1.7 - Sources

RESEARCH REFERENCE POINT

70° N

19° E

TROMSØ

1.1 - Arctic

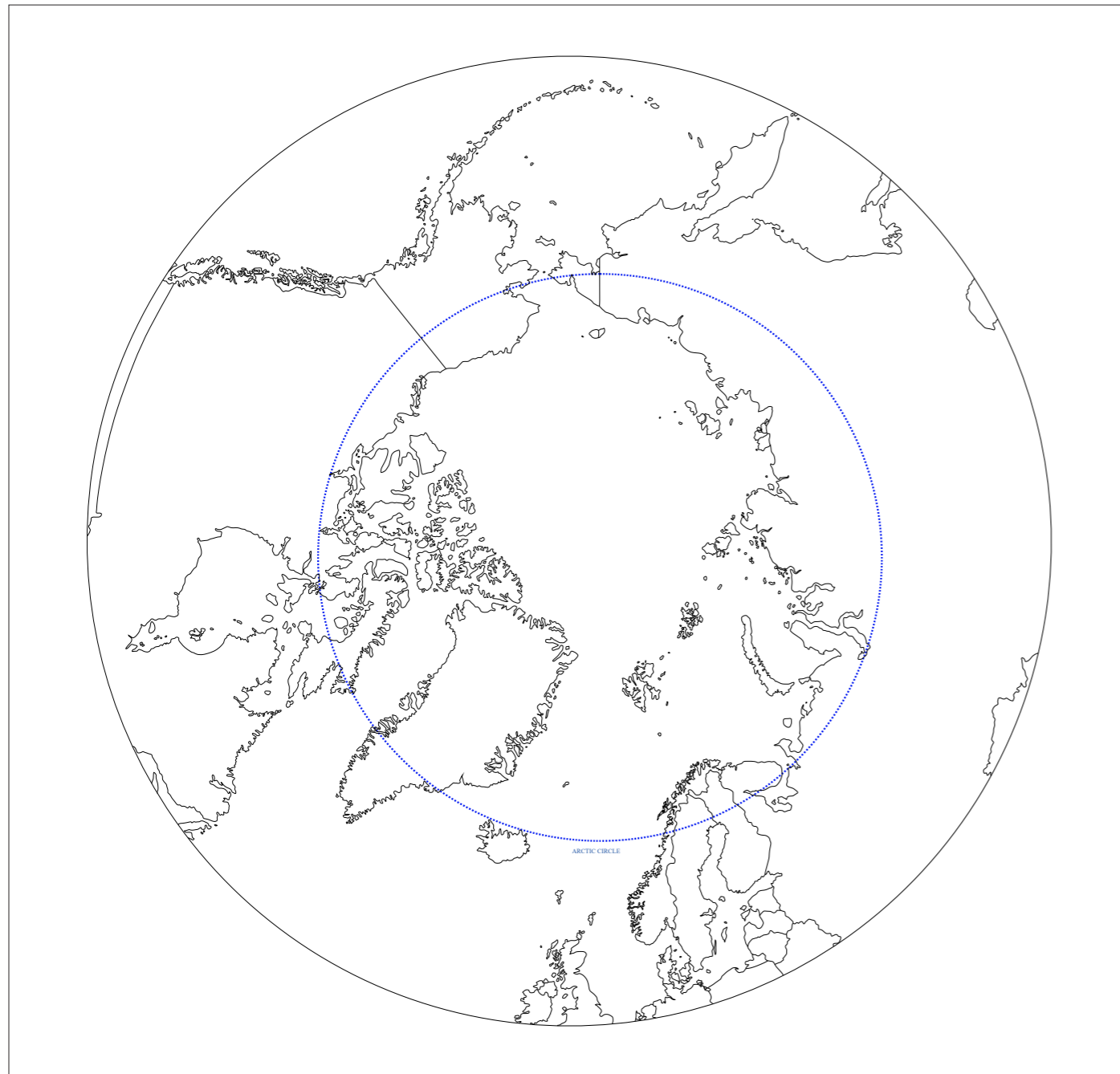

Arctic is an area located at approximately 66 degrees north, marked as a blue dashed line in the illustration above. Countries like: Norway, Sweden, Iceland, Finland, Greenland (Denmark), Russia, US, and Canada are all located in the intersection of the arctic border. This specific region is known for having a harsh climate with particular summers and winters. During summer you can experience the sun being above the horizon for 24 hours, condition that is called the polar-day or midnight-sun. In winter on the contrary the sun never gets above the horizon during daytime making it completely dark*, polar-night. *It should be mention that areas that are located closer to the arctic border can still experience some sunlight due to curvutere of the earth and atmospheric refraction.¹

¹ GEOGRAPHYREALM, <<Arctic Circle>>, by Caitlin Dempsey, read 27.08.23. <https://www.geographyrealm.com/arctic-circle/>

1.2 - Arctic circle - Norway

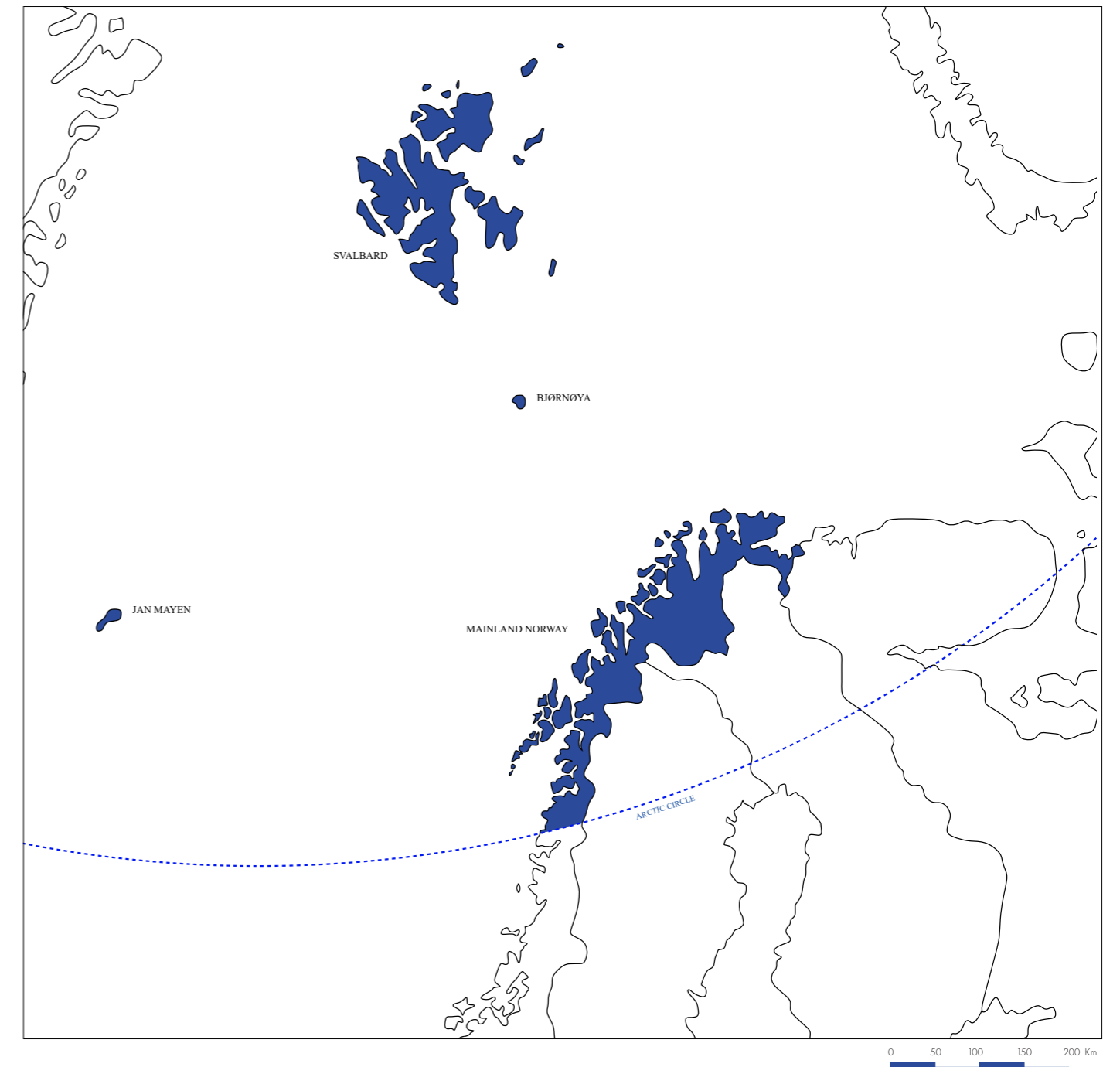

A big part of Norway consists of several parts within the arctic circle; Jan Mayen at approximately 71° N, Bjørnøya 74° N, Svalbard 76° - 80° N and Mainland Norway at 67° - 71° N. Note that Arctic is hard to define by a simple line and there is no clear reference to where the arctic border starts. Due to the interest in light conditions within this diploma the reference points are located above 66° N.² Despite arctic region of Mainland Norway (Troms&Finmark and northern part of Nordland) being located above the arctic circle it is not as cold as places located further south in many other countries. The norwegian coastline is - due to the Gulf Stream - completely ice free and because of that has given an opportunity to create settlements and making this region habitable. Svalbard on the other hand is closer to temperatures that are considered being normal at this latitudes. It is also an area that experiences biggest changes caused by the climate change and affect the ecological conditions. This goes for the northern region of Mainland Norway aswell.³

² FRAMSENERET, <<Hva er Arktis?>>, by Kjetil S. Grønnestad, BarentsWatch, read 09.12.23. <https://framsenteret.no/arkiv/hva-er-arktis-5809086-146437/>

³ THE ARCTIC INSTITUTE, <<Norway>>, by Unknown, read 29.08.23. <https://www.thearcticinstitute.org/country-backgrounders/norway/>

1.3 - Inhabitants

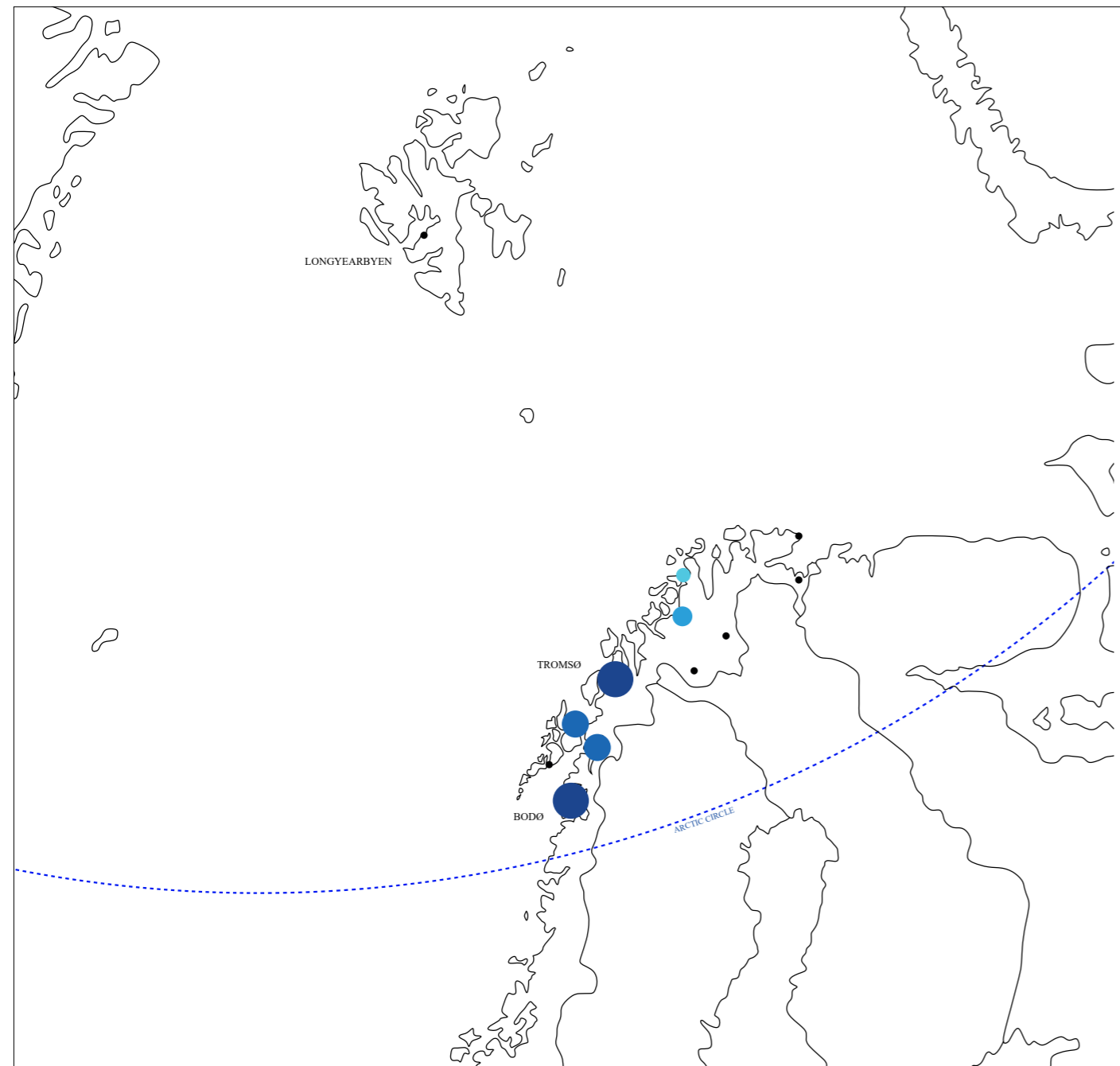

Of all the countries located in the intersection of arctic circle, Norway happens to have a population of around 480 000 people living in that region. This makes it one of the largest accumulation of people on earth to live above the arctic circle. The two biggest cities within this region are Tromsø (approx. 76 000 inhabitants, 2019) and Bodø (approx. 52 000 inhabitants, 2019). Some part of the arctic population in Norway is also inhabited by Sámi, indigenous group of people that contain around 50 000 inhabitants. Sápmi - lands of Sámi, is stretching across several nordic countries and Russia.⁴

⁴ THE ARCTIC INSTITUTE, <<Norway>>, by Unknown, read 29.08.23. <https://www.thearcticinstitute.org/country-backgrounders/norway/>

1.4 - Tromsø



Fig.1: Perspektivet Museum, *Måne over Tromsdalstinden*, Tromsdalen og Tromsdalstinden sett fra Tromsøya. 1955. <https://www.flickr.com/photos/perspektivmuseum/7087173365/in/album-72157634246871890/>

Tromsø, often called Nordens Paris (Paris of the North) as mentioned earlier is one of the largest city above the arctic circle. The city lays in the county of Troms og Finnmark. The main part of the city lies on the island of Tromsøya but it also consists of the suburban and peripheral areas located, instead, on the island of Kvaløya to the west and on the mainland to the east. The main island, that is Tromsøya, is connected to both sides by bridges and an underwater tunnel.

The city has expended rapidly since the second World War, mostly thanks to the opening of Tromsø Airport (1964) that is located on the western part of Tromsøya - and the opening of the northernmost University in the world (1972), leading to further increase of the population and growth of the city.

The area is surrounded by several tall mountains such as: Store Blåmann, Store Fornestinden, Hamperokken, Jiehkkevárri and Tromsdalstinden.⁵ Due to Tromsøs location it attracts a lot of tourists to visit and experience conditions this area has to offer throughout the whole year. From city walks and hiking to experience midnight-sun during summer and northern lights during winters, the last one has especially exploded during the last years and the northern lights industry has become a big thing in Tromsø.⁶

⁵ STORE NORSKE LEKSIKON, <<TROMSØ>>, by Geir Thorsnæs; Trond Olav Svendsen and Lars Engerengen, read 09.12.23. <https://snl.no/Troms%C3%B8>

⁶ northernnorway, <<Tromsø>>, by Unknown, read 31.08.23. <https://nordnorge.com/en/destinasjon/tromso/>



SCALE 1:50 000



Fig.2: Pedersen David, <<FULL MOON DURING POLAR NIGHT>>. Scan of aquarelle painting.

FULL MOON DURING POLAR NIGHT



Fig.3: Pedersen David, <<POLAR NIGHT>>. Scan of aquarelle painting.

POLAR NIGHT



Fig.4: Pedersen David, <<POLAR DAY-MIDNIGHTSUN>>. Scan of aquarelle painting.

POLAR DAY - MIDNIGHTSUN

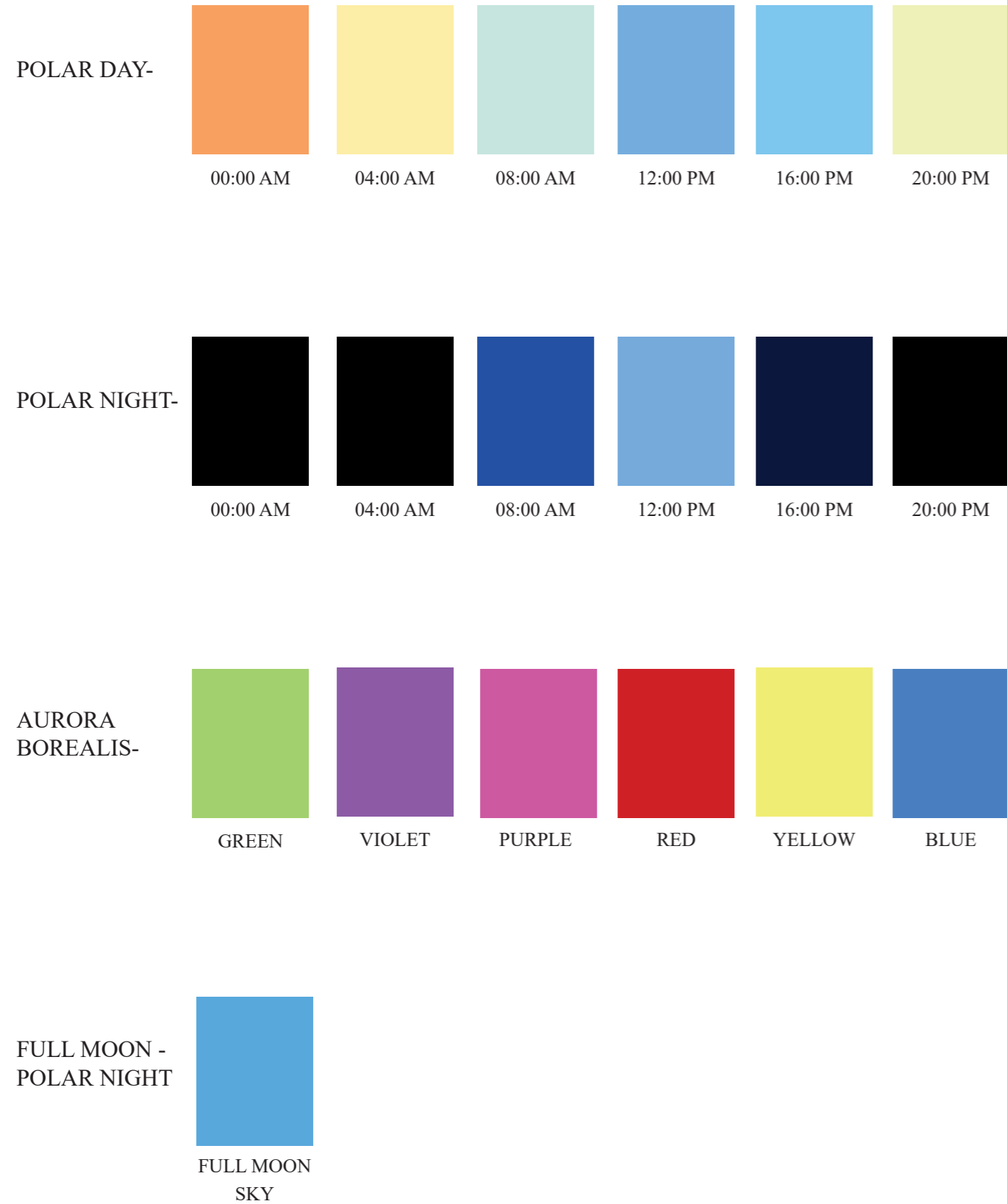

Fig.5: Pedersen David, <<AURORA BOREALIS - DURING POLAR NIGHT>>. Scan of aquarelle painting.

AURORA BOREALIS - DURING POLAR NIGHT

1.5 - Light conditions

Colors that occur on the sky during polar night and day.



1.6 - Pictures of Tromsø - field trip august 2023



Fig.6:



Fig.7:

Fig.8:



Fig.9:

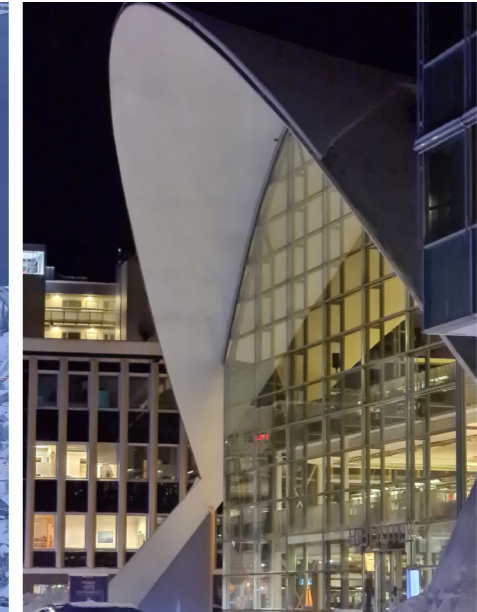

Fig.10:



Fig.11:

Fig.12:



Fig.13:



Fig.14:



Fig.15:

Fig.16:



Fig.17:

Fig.18:



Fig.19:

Fig.20:



Fig.21:



Fig.22:



Fig.23:

Fig.24:



Fig.25:



Fig.26:



Fig.27:



Fig.28:



Fig.29:

Literature and other sources

EndNotes

- 1 GEOGRAPHYREALM, <<Arctic Circle>>, by Caitlin Dempsey, read 27.08.23. <https://www.geographyrealm.com/arctic-circle/>
- 2 FRAMSENTERET, <<Hva er Arktis?>>, by Kjetil S. Grønnestad, BarentsWatch, read 09.12.23. <https://framsenteret.no/arkiv/hva-er-arktis-5809086-146437/>
- 3 THE ARCTIC INSTITUTE, <<Norway>>, by Unknown, read 29.08.23. <https://www.thearcticinstitute.org/country-backgrounders/norway/>
- 4 THE ARCTIC INSTITUTE, <<Norway>>, by Unknown, read 29.08.23. <https://www.thearcticinstitute.org/country-backgrounders/norway/>
- 5 STORE NORSKE LEKSIKON, <<TROMSØ>>, by Geir Thorsnæs; Trond Olav Svendsen and Lars Engerengen, read 09.12.23. <https://snl.no/Troms%C3%B8>
- 6 northernnorway, <<Tromsø>>, by Unknown, read 31.08.23. <https://nordnorge.com/en/destinasjon/tromso/>

Photos and illustrations

Fig.1: Perspektivet Museum, *Måne over Tromsdalstinden*, Tromsdalen og Tromsdalstinden sett fra Tromsøya. 1955. <https://www.flickr.com/photos/perspektivmuseum/7087173365/in/album-72157634246871890/>

Fig.2: Pedersen David, <<FULL MOON DURING POLAR NIGHT>>. Scan of aquarelle painting.

Fig.3: Pedersen David, <<POLAR NIGHT>>. Scan of aquarelle painting.

Fig.4: Pedersen David. <<POLAR DAY-MIDNIGHTSUN>>. Scan of aquarelle painting.

Fig.5: Pedersen David. <<AURORA BOREALIS - DURING POLAR NIGHT>>. Scan of aquarelle painting.

Fig: 6, 12, 13, 14, 15, 18, 19, 20, 21, 22, 23, 24, 25, 26, 27, 28 and 29: Pedersen David. Field trip august 2023.

Fig: 7, 8, 9, 10, 11, 16 and 17: Pedersen David. Private trip december 2021.

2. INTRODUCTION TO THE THEME - RESEARCH

- 2.1 - Research question/s
- 2.2 - Methods
- 2.3 - Heliodon 1 - process
- 2.4 - Heliodon 2 - process
- 2.5 - Interview locals - statistics
- 2.6 - Interview professionals & history
- 2.7 - Case studies
- 2.8 - Sources

2.1 - Research question/s

How can architecture adapt to extreme diversification in daylight conditions within the Arctic - Norway?

Tromsø and Oslo separately contain almost equal amount hours of daylight in a year. Tromsø around 4541 hours, Oslo around 4441 hours.

Therefore there should not be any significant differences within architectural language in housing typology regarding topic of daylight, other than climatic or perhaps social differences in the cities/regions and its affection on the architecture.

Situated at a latitude of approximately 70 degrees North, Tromsø-the capital of Northern Norway-is located above the Arctic circle experiencing huge diversification in daylight conditions throughout the year, from everlasting sun conditions during the summer-known as the midnight sun-to dark period in winter - known as polar-nights. As I have been traveling to the North exploring cities such as; Tromsø, Bodø, Vardø and other smaller cities and villages in the county of Troms&Finnmark, I have experienced architecture being oddly similar to the one we find in the southern part of Norway. The shape of a single-family house, the quantity of the windows, its size and materials used for construction and cladding speak more or less the same language.

Daylight conditions play an important part of humans wellbeing, and affect our daily routines. It is a vital component for our society to function on everyday basis.

Pre - diploma questions:

- Why is the architecture within housing typology in Tromsø (Northern-Norway) so similar to Oslo (Southern-Norway)?
- Why has it not been challenged or been more adapted to its extreme diversification in daylight conditions?
 - Are there any historical aspects that had an impact on architecture within housing typology in Arctic-Norway regarding topic of daylight?
 - Are people in Northern Norway more adapted to its specific daylight conditions?
- Should the light qualities that occur in the north be given more importance to within single family house typology? How can we bring this light inside our homes when it is needed the most?

Methods:

For my investigation I am going to focus on five methods that could answer or raise new questions regarding my topic and develop it into a final project.

1. Sun analysis. To better understand the working area, I wish to work with both analog and digital tools. As I am intending to work with daylight, materials and its reflection of light will play an important role in the whole design process. Therefore, I will look into different practices in which daylighting can be simulated physically in a model.

2. Interview with the locals. As my diploma is strictly based on information found in literature and research on the internet, I intend to include information from people who actually live in Northern Norway (Tromsø), to understand what their needs are today and perhaps in the future. This could potentially open for a discussion regarding the house program and create something that is based on a collective understanding for a change.

3. History of Architecture in Northern Norway. I will investigate the history regarding topic of daylight in housing architecture within the arctic Norway. Through the conversations with professionals and literature.

4. Interview with an architecture office in the North. My goal is to have an interview with offices to gain information and their point of practice in architecture considering light conditions in the North.

5. Case studies. Analysis of projects with focus on daylighting, not specifically about extreme changes in daylight conditions, but program, tectonics and materials that could provide new light experiences.

1. Sun analysis. To understand light better, I wish to work with both analog and digital tools. As I am intending to work with daylight, reflection of light will play an important role in the whole design process. Therefore, I will look into different practices where daylighting can be simulated physically in a model.

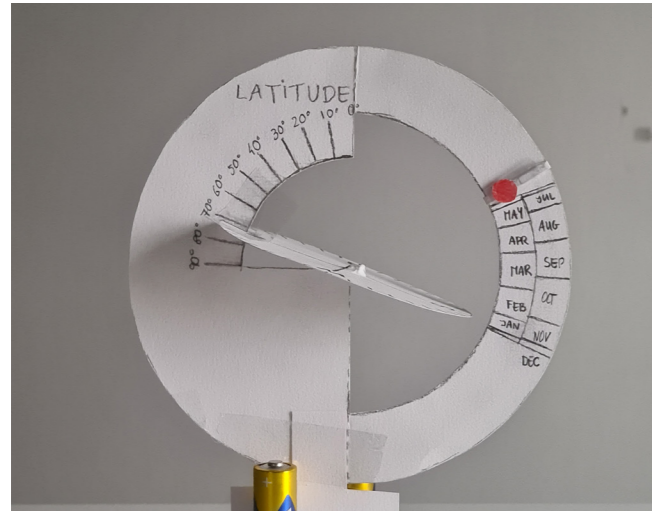

Fig. 1: Pedersen David: Paper model of solar demonstrator

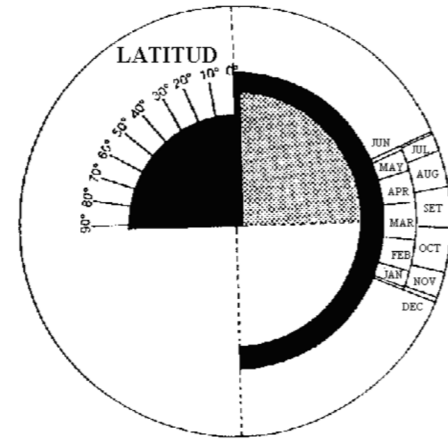

Fig. 13: The main part of the solar demonstrator for the Northern Hemisphere.

Fig. 2: Ros M. Rosa, Berthomieu Francis. Stellar, solar and lunar demonstrator.



Fig. 3: Ekko, Sakari. How to build a big plywood demonstrator.

During my pre-diploma semester I have looked into different practices of simulating the sun in a physical model. After reading paper of Rosa M. Ros & Francis Berthomieu I started to make a smaller paper version of the simulator (Fig. 1) based on the given manual.¹ Furthermore I combined it with paper and plywood demonstrator made by Sakari Ekko (Fig. 3).² This has resulted in a sketching and model process to both understand and achieve a result that could be used during research phase with physical models. The next pages illustrate the process and result, two types of a heliodon.

1 Ros, Berthomieu, *Stellar, solar and lunar demonstrators*

2 Ekko, *How to build a big plywood demonstrator*

Fig. 4:

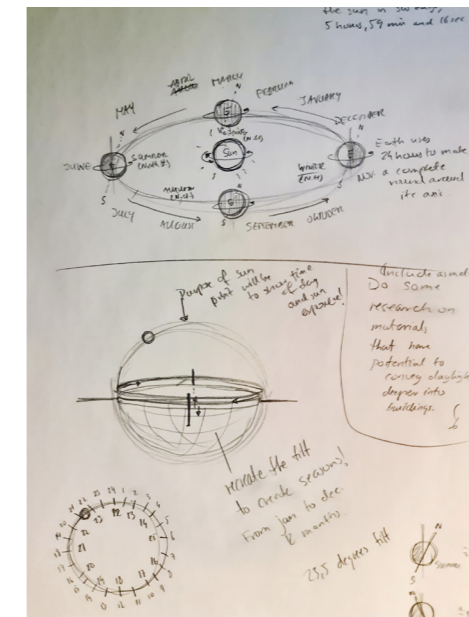

Fig. 6:

Fig. 5:

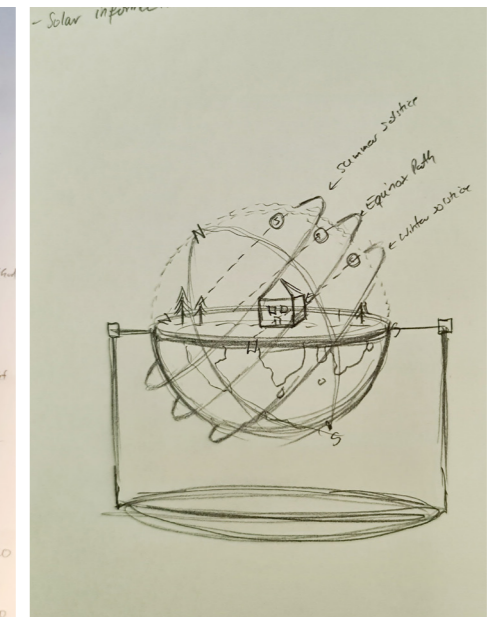

Fig. 7:

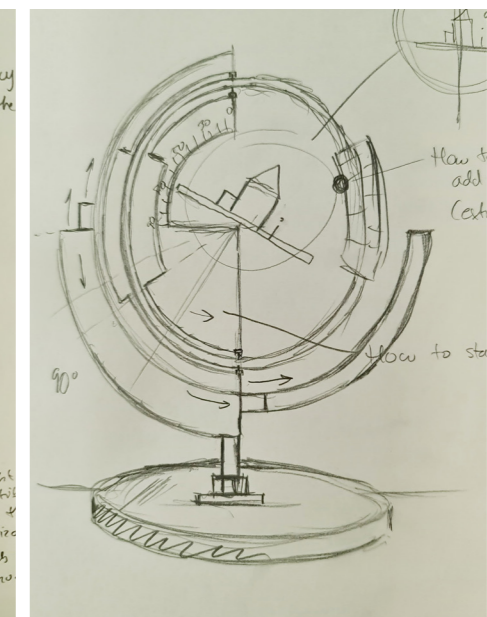
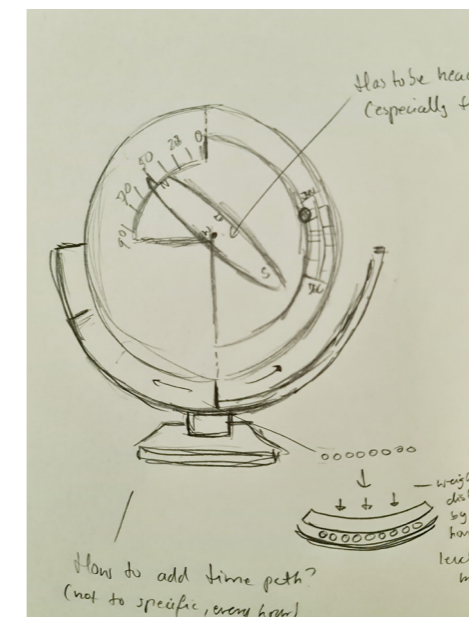

Fig. 8:

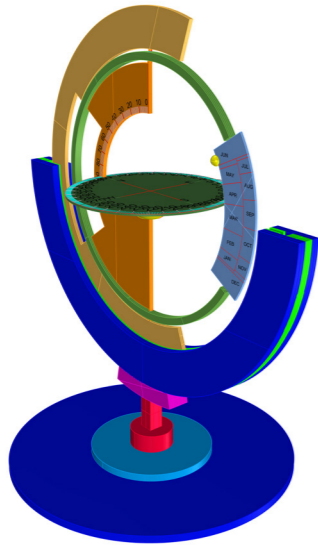

Fig. 9:

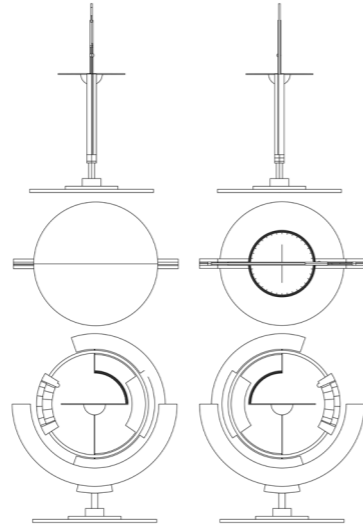

Fig. 10:

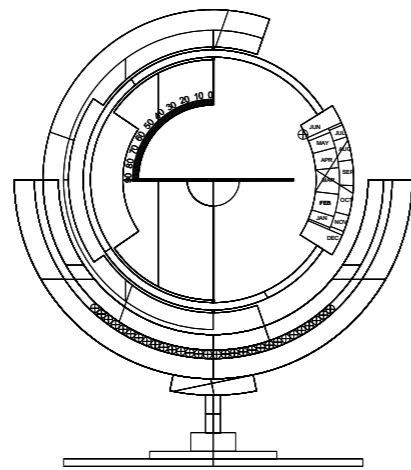

Fig. 11:

Fig. 12:

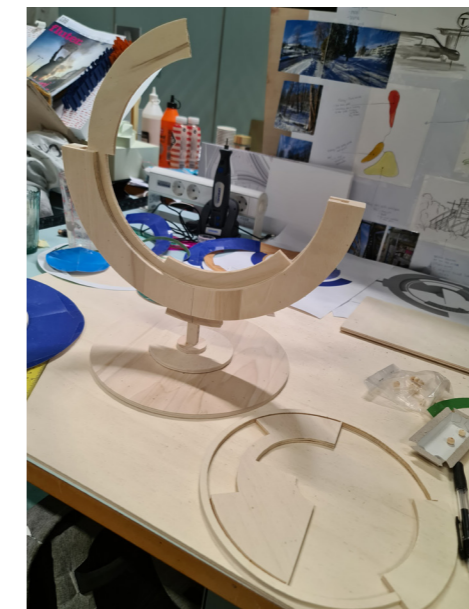

Fig. 13:



Fig. 14:

2.3 - Heliodon 1 - process - PRE-DIPLOMA

Completed concept model for the sun analysis

Fig. 15:



Fig. 16:



Fig. 17:



Fig. 18:

2.3 - Heliodon 1 - process - PRE-DIPLOMA

Sun analysis model in use showing sunpath for Tromsø (69 degrees north) during January, February, March and June. Pictures are taken with phone camera using long exposure to recreate the sunpath.

Fig. 19: 22: June



Fig. 20: 23: March



Fig. 21: 24: February



Fig. 22: 25: January

The final design of the Heliodon* is based on the concept model. Errors that occurred were either redesigned or replaced for proper functionality. Model will be made of 12mm thick MDF board and metal components.

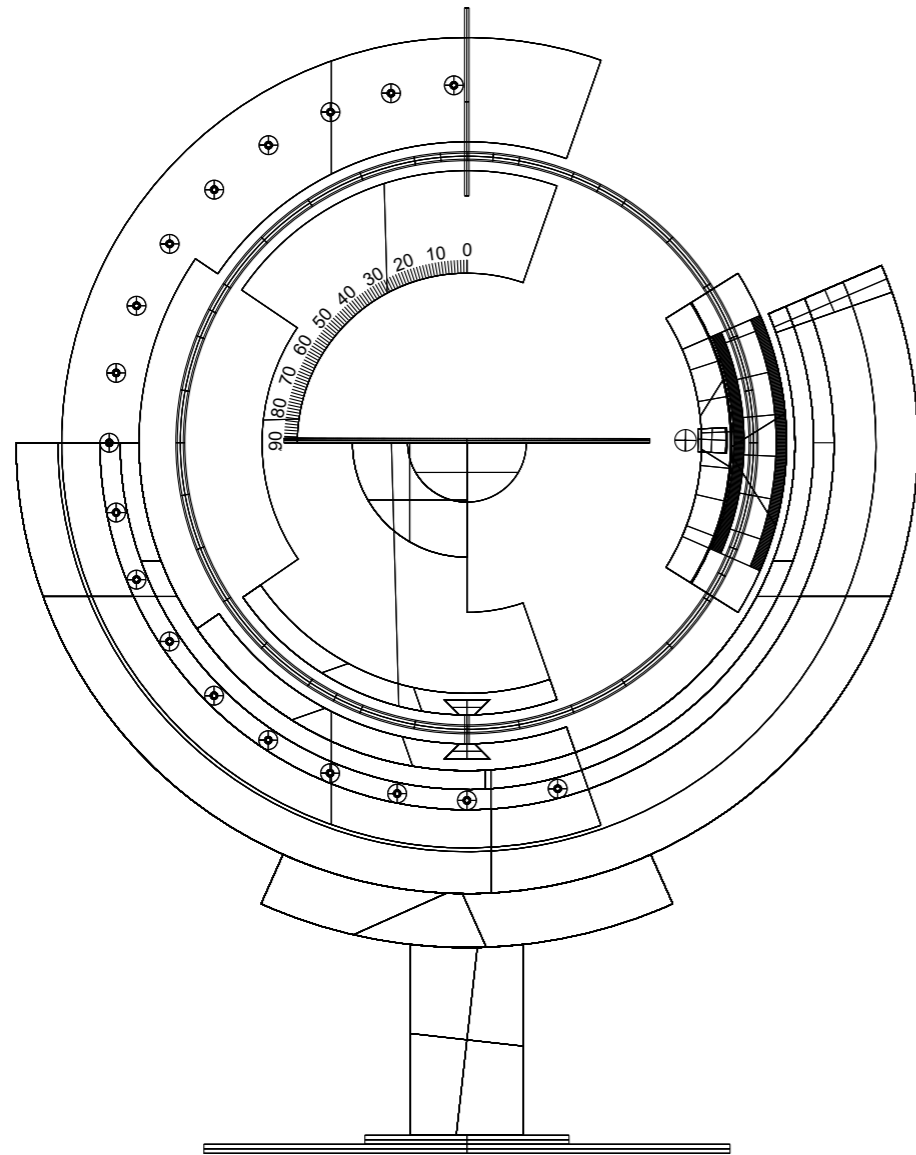
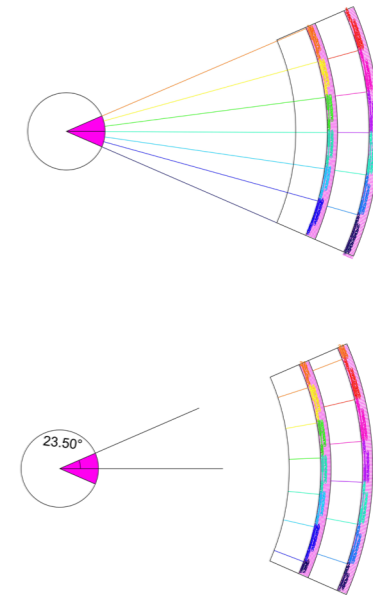

Fig. 23:

* A heliodon is a device that can be used for architectural purposes, as light studies of a physical model.³

!Calculations and date - scale got verified in a 3D model on a random day of the year before building the physical model !



Days in a year: 365
 Earth tilt: approx. 23.5 degrees

Equinoxes:
 March - 20
 September - 22/23

Solstices:
 Summer - 20/21 (june)
 Winter - 21/22 (december)

$365 \text{ days} : 2 = 182,5 \text{ days}$
 $23.5 \text{ degrees} + 23.5 = 47 \text{ degrees}$
 $47 \text{ degrees} : 182,5 \text{ days} = 0,2575$

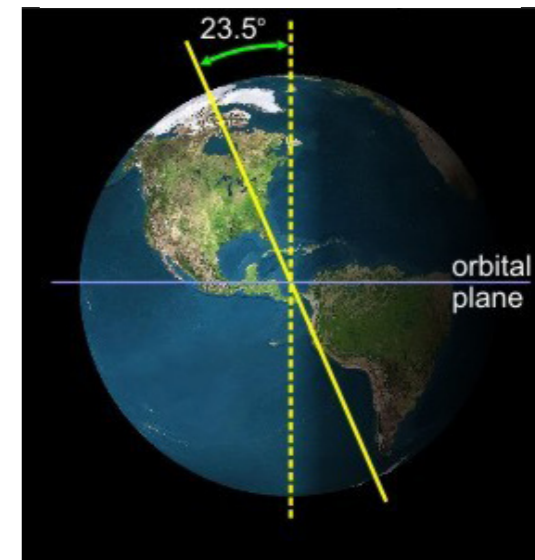

Fig. 24: Babb, David

³ Øyvind Aschehoug, *Dagslys i bygninger: prosjekteringsveiledning*. (Stabekk: Lyskultur, 1998), 44.

Fig. 25:



Fig. 26:



Fig. 27:



Fig. 28:

Fig. 29:

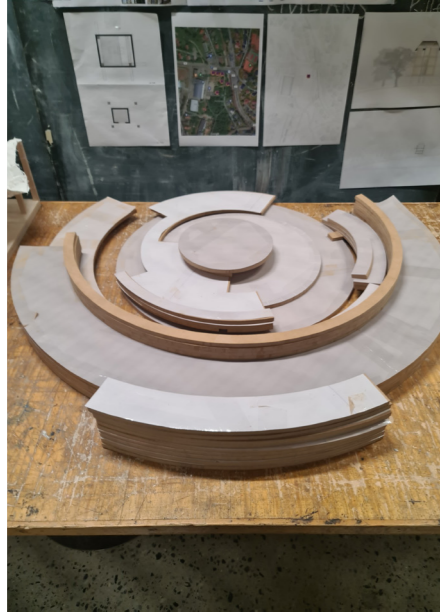

Fig. 30:

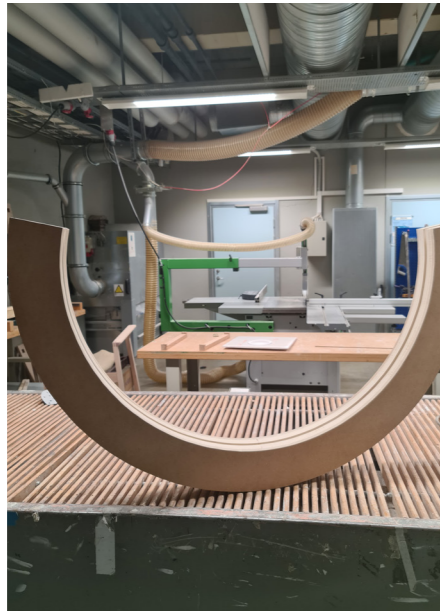

Fig. 31:



Fig. 32:

Fig. 33:

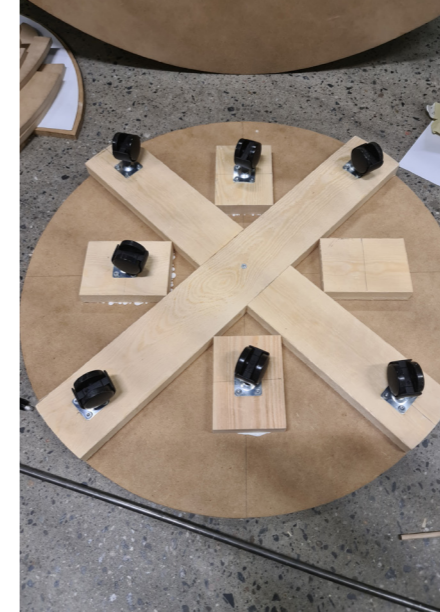

Fig. 34:



Fig. 35:



Fig. 36:

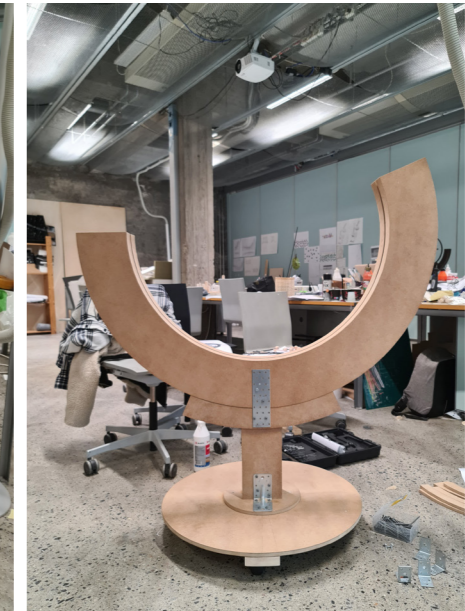

Fig. 37:

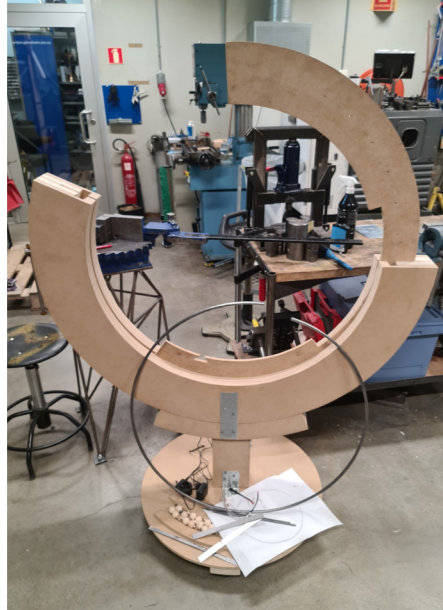

Fig. 38:



Fig. 39:



Fig. 40:

Fig. 41:



Fig. 42:



Fig. 43:



Fig. 44:



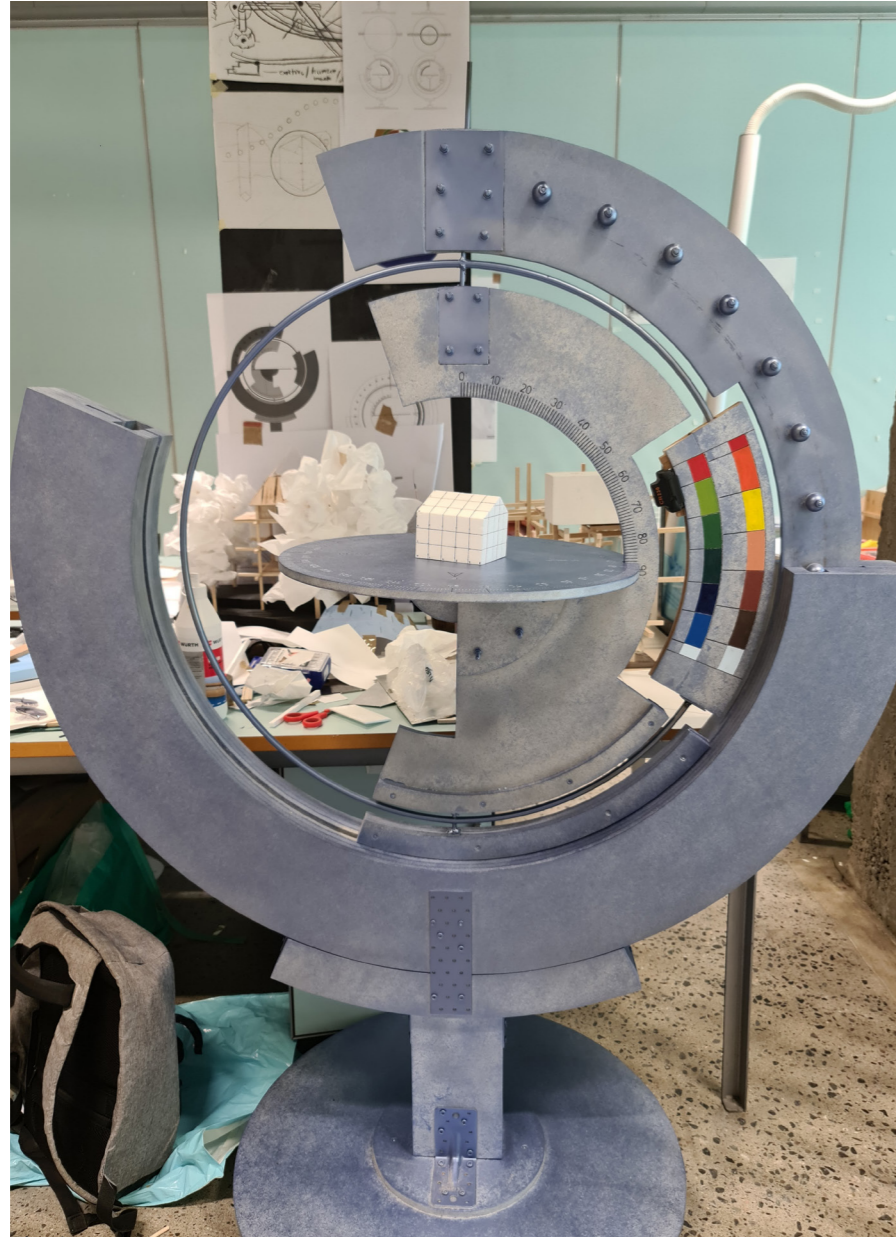

Fig. 45:

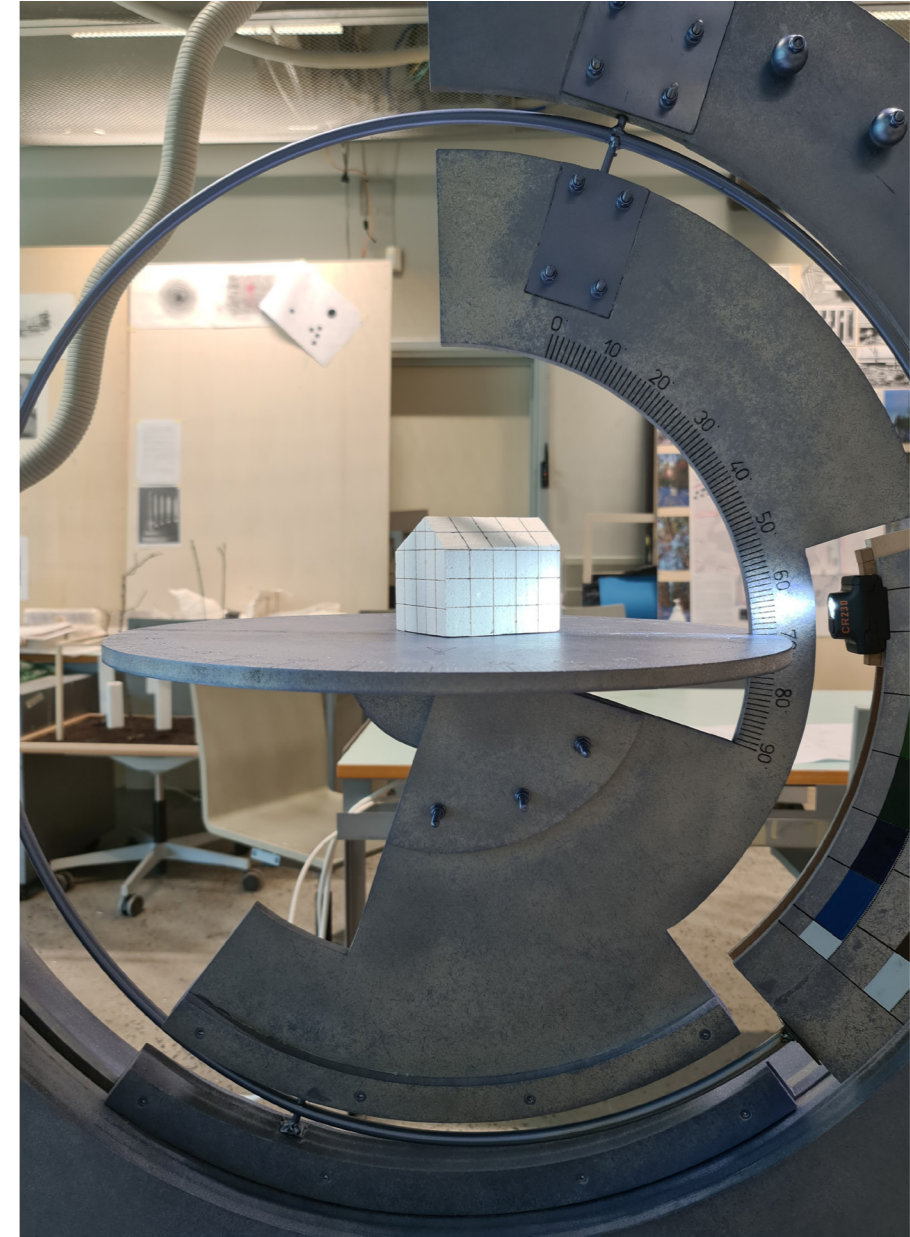

Fig. 46:

Fig. 47:



Fig. 48:



Fig. 49:



Fig. 50:

Heliodon will be verified
Location: Oslo + other latitudes. Unknown where now.
Date and time: (unknown, once model is done, may?)
Physical model: A verification cube with a grid
Take picture of a specific side that cast shadow on the facade of the verification cube in Oslo. Repeat it in the Heliodon.
Compare the results.
(Verification cube will be taken to different locations in Southern Europe for further verification on different latitudes)
Some Inaccuracy is expected.

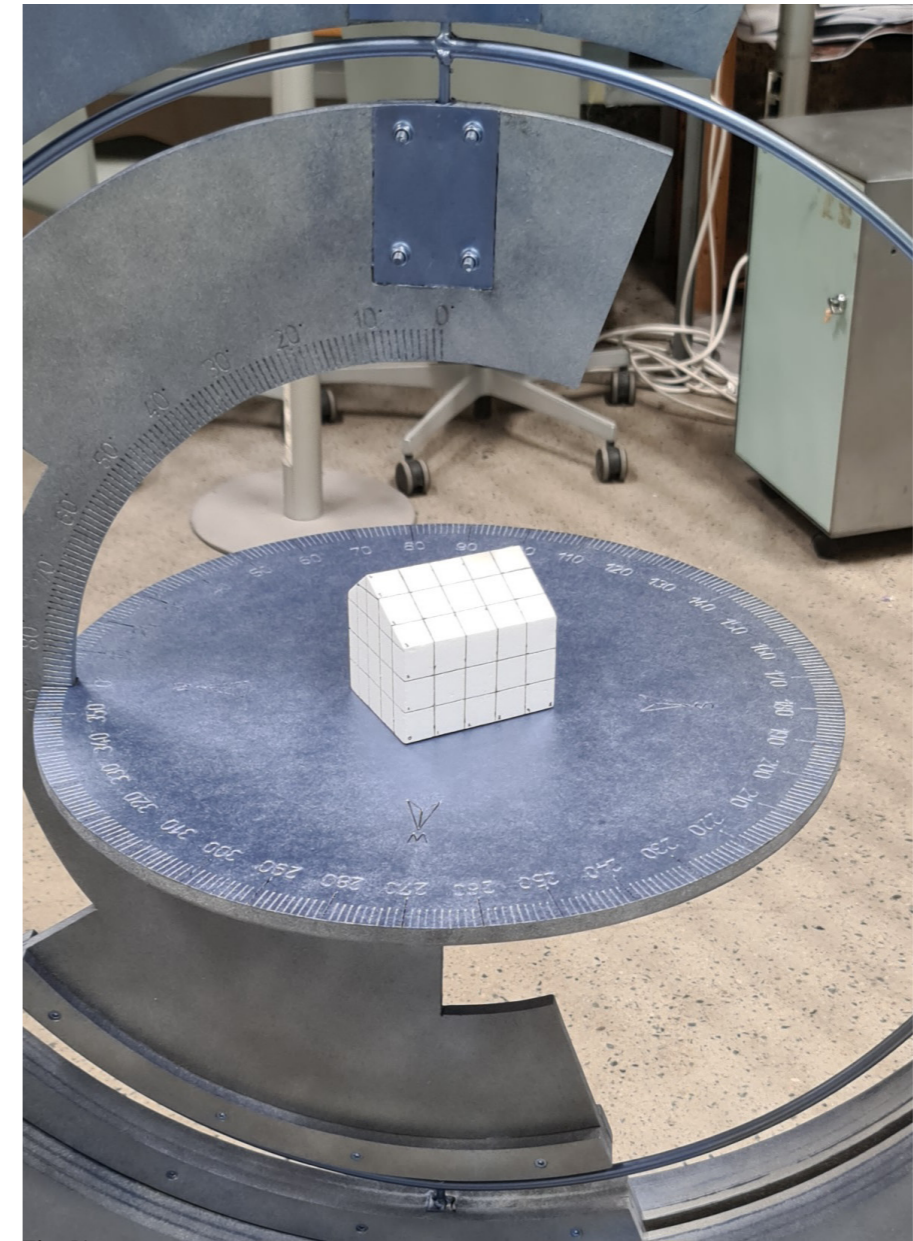

Fig. 51:

2.3 - Heliodon 1 - process - Summer 2023

Verification of Heliodon

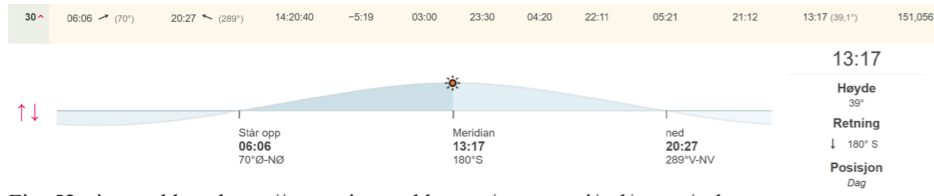

Fig. 52: timeanddate, <https://www.timeanddate.no/astronomi/sol/norge/oslo>

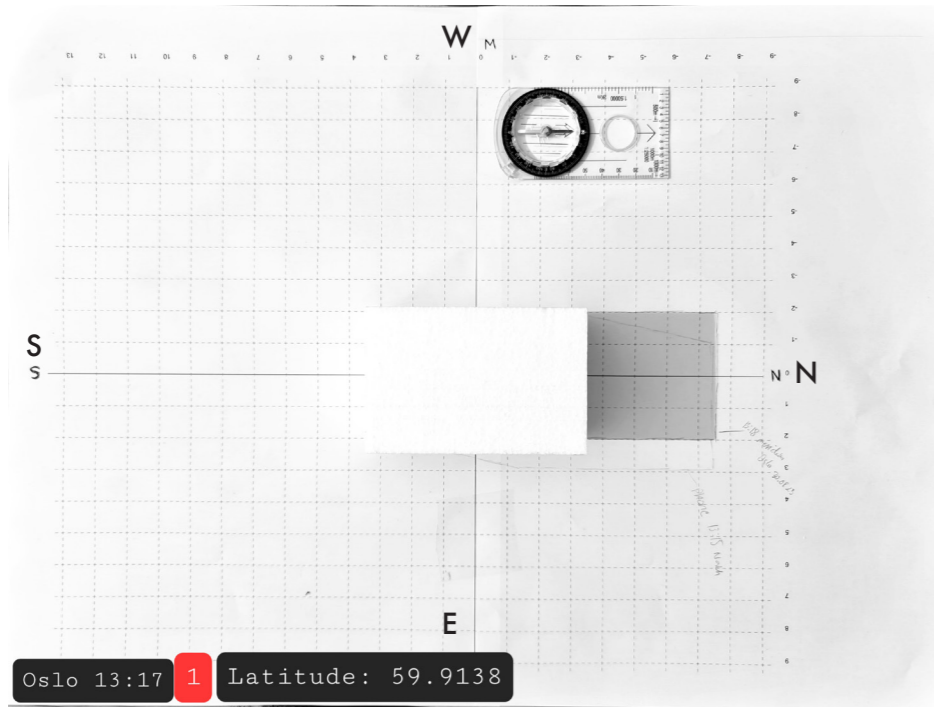

Fig. 53: Photo of sun analysis: Oslo, 13:17, 30.08.2023

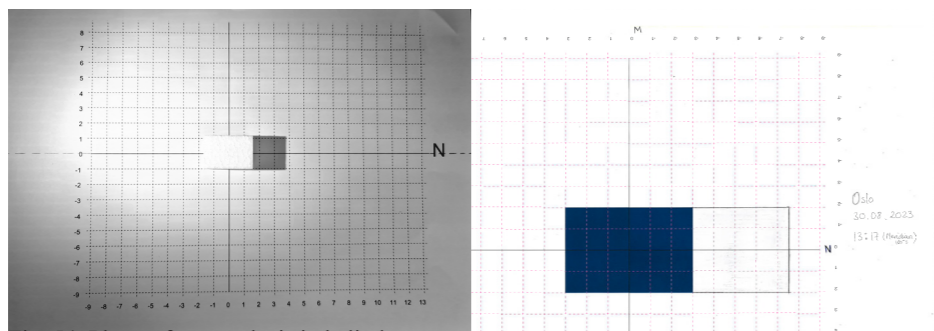
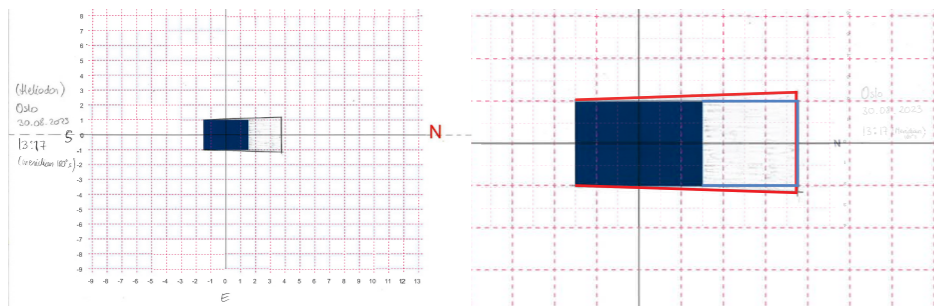

Fig. 54: Photo of sun analysis in heliodon: Oslo, 13:17, 30.08. Shadow: Sun analysis at the location



Shadow: heliodon Overlap BLUE: Sun analysis at the location RED: Heliodon

2.3 - Heliodon 1 - process - Summer 2023

Verification of Heliodon

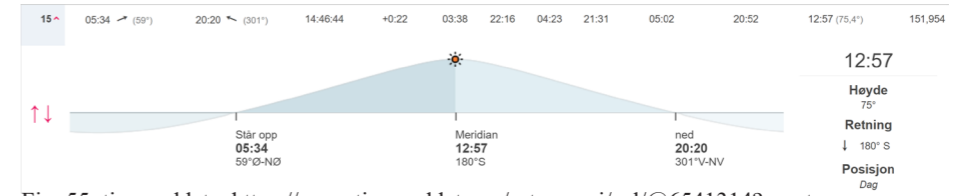

Fig. 55: timeanddate, <https://www.timeanddate.no/astronomi/sol/@6541314?month=6&year=2023>

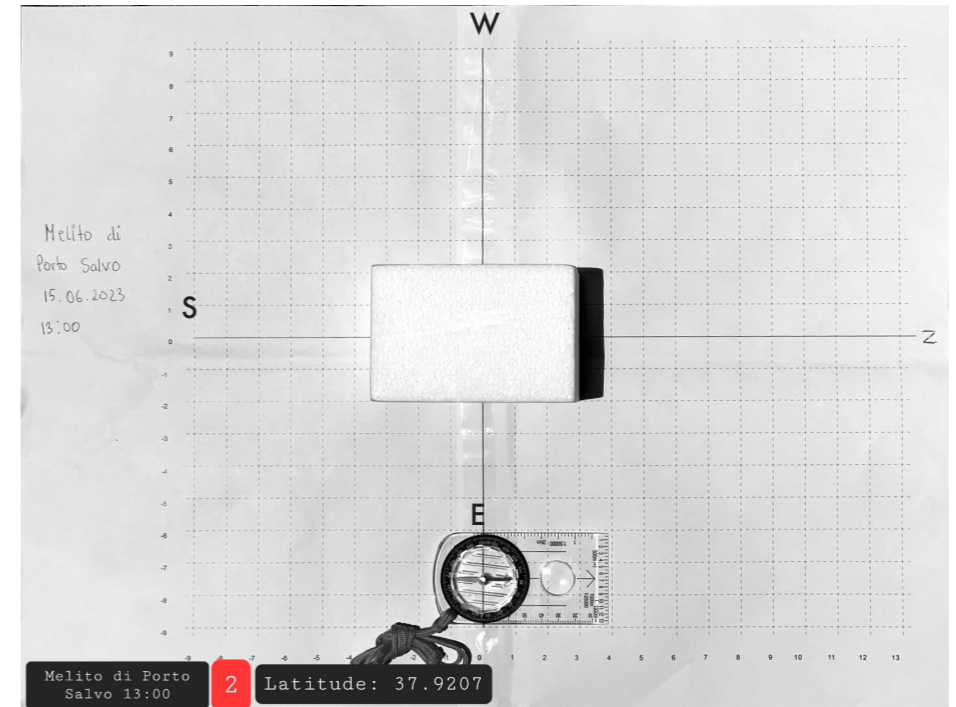

Fig. 56: Photo of sun analysis: Melito di Porto Salvo. 13:15, 15.06.2023

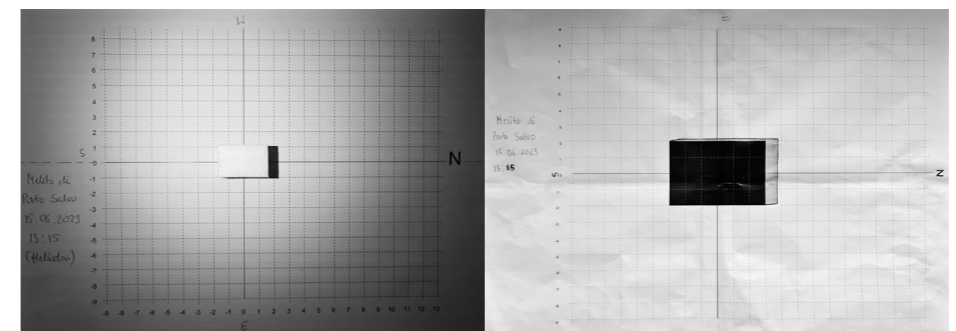
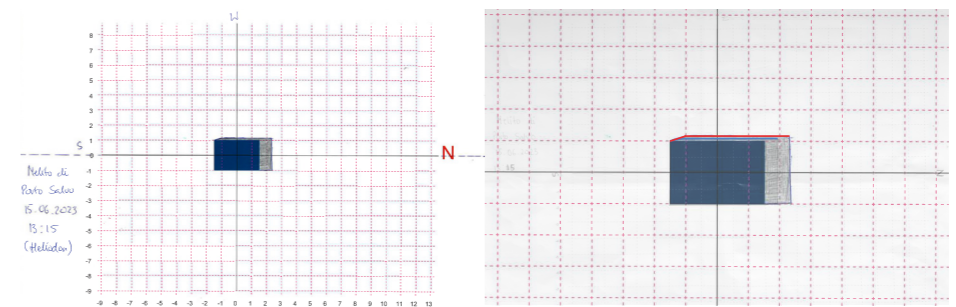

Fig. 57: Photo of sun analysis in heliodon: Melito di Porto Salvo. 13:15, 15.06. Shadow: Sun analysis at the location



Shadow: heliodon Overlap BLUE: Sun analysis at the location RED: Heliodon

Verification of Heliodon

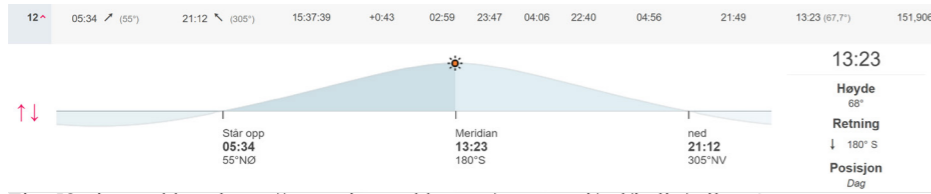

Fig. 58: timeanddate, <https://www.timeanddate.no/astronomi/sol/italia/milano?mont->

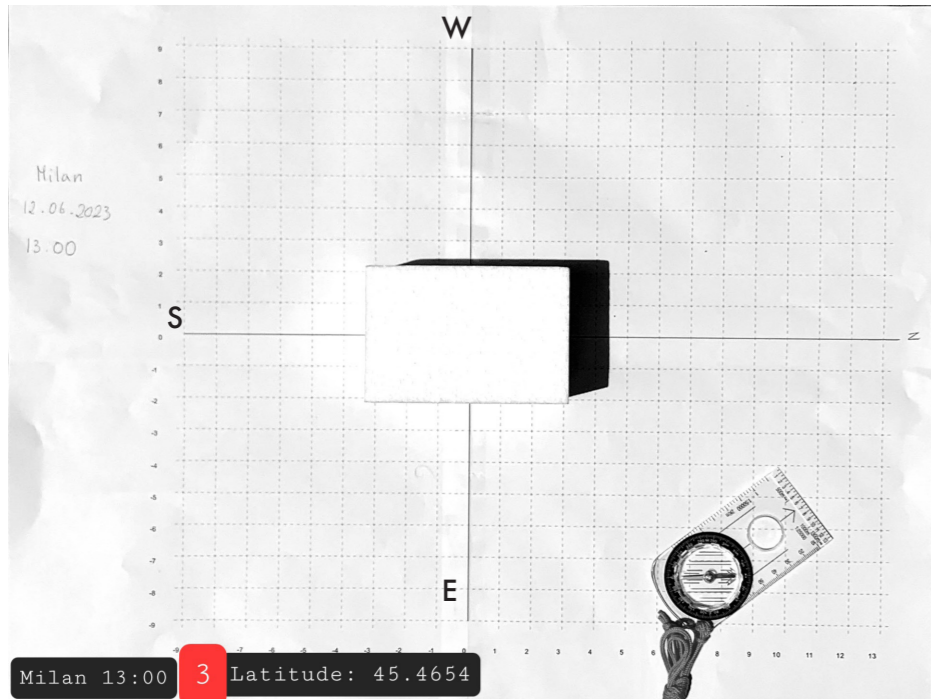

Fig. 59: Photo of sun analysis: Milan, 13:00, 12.06.2023

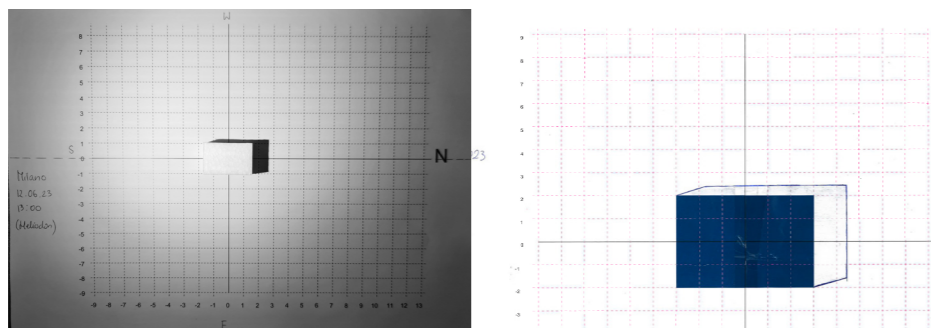
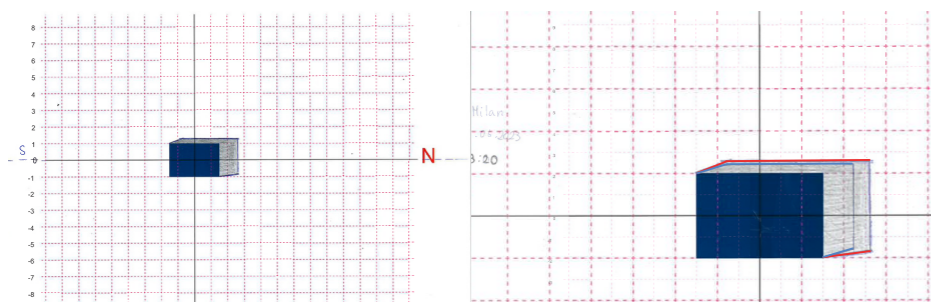

Fig. 60: Photo of sun analysis in heliodon: Milan. 13:00, 12.06
Shadow: Sun analysis at the location



Shadow: heliodon
Shadow: Overlap
BLUE: Sun analysis at the location
RED: Heliodon

Verification of Heliodon - Concluding words



Fig. 61: Attinà, Luca, Sun analysis in Milano

Results got some inaccuracy as shown in the analysis of sun studies from different locations in Europe to heliodon. This can be based on different factors:

- While doing sun analysis in different locations in Europe inaccuracy in the compass tool used to find North could have an affection on the result as the verification base was placed incorrectly according to celestial directions.
- Exact time the picture was taken some minutes can be off +/- affected on weather conditions (clouds).

Every minute that is off has an impact on the shadow and its angle.

- Heliodon: It is not build in "scale" as it would have to refer to distance of the sun from earth that is changing every day. Furthermore the model was made by hand and some inaccuracy regarding the montage of all parts were expected.

- The distance and shadows from the light source (sun) in the heliodon would be even more accurate if placed further away from the object, creating straight lines parallel to each other. Closer distance to an object creates longer shadows.

Conclusion: I will illustrate my hypothesis in a simplified model showing conditions mentioned above in practice. Heliodon is not expected to be a total representation on how the earth orbits the sun during a 365 days cyclus. It is, rather, a tool to help me understand better how the light enters spaces in dwellings that get affected by light in a very irregular way through all the seasons of the year.

2.3 - Heliodon 1 - process

Experiment



Fig. 62:

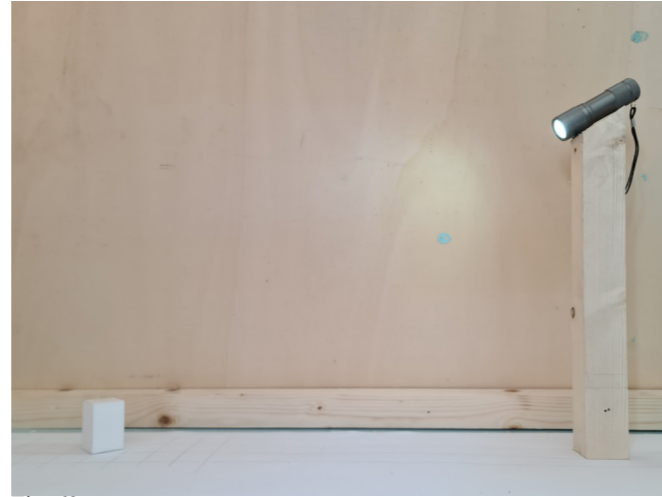

Fig. 63:

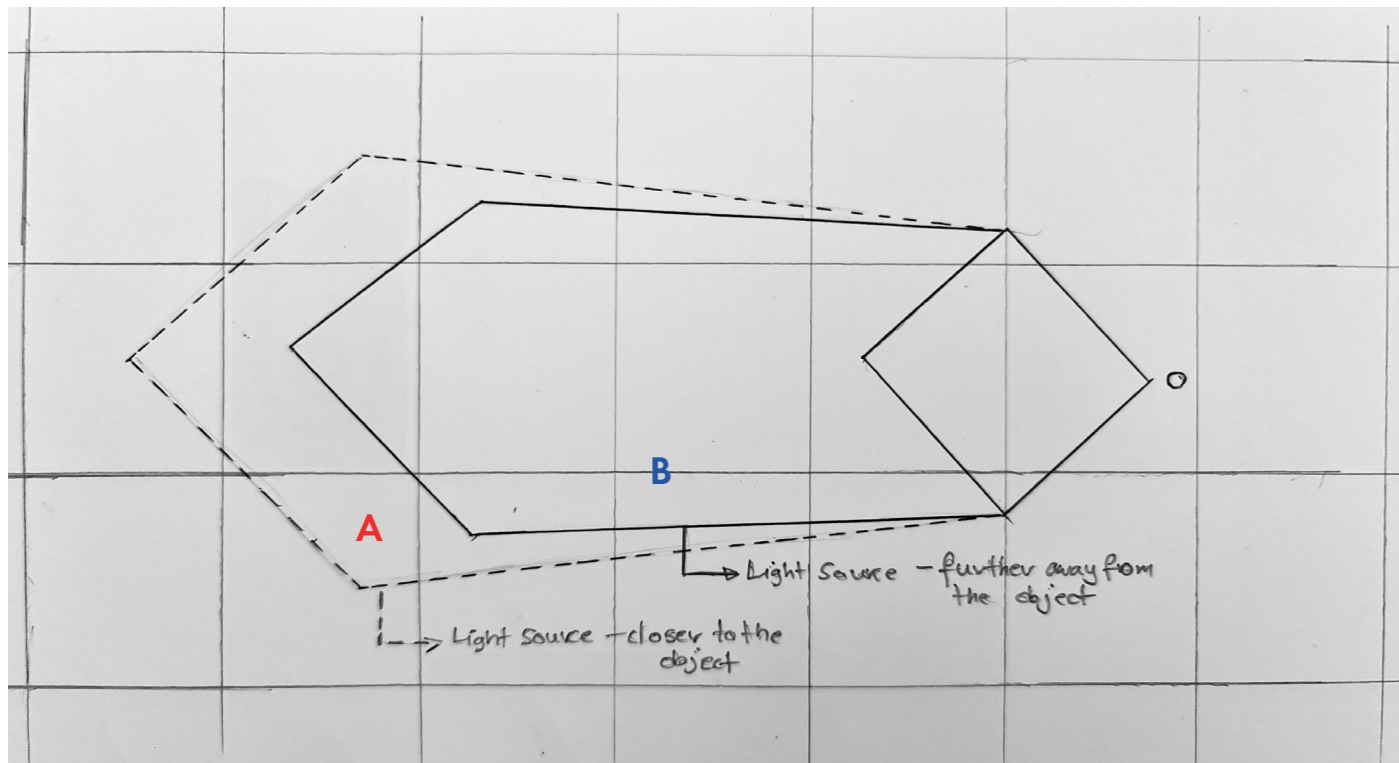

Fig. 64:

A - Light source close to the object

B - Light source further away from the object

2.3 - Heliodon 1 - process

Experiment - EQUINOX 23. september, Meridian - 12:37 (S 180) - Tromsø (approx 70 degrees N)



Fig. 65: Sun analysis in Heliodon



Fig. 66: shademap, read 3.12.2023, <https://shademap.app/@69.64976,19.0285,9.73412z,1695465457648t,0b,0p,0m!1697695845732!1697726996340,qdHJvbXPDUA=!69.6492!18.95532>

2.4 - Heliodon 2 - process - using sun as light source

Another type of heliodon using sun as a light source. The model is made by Sakari Ekko.

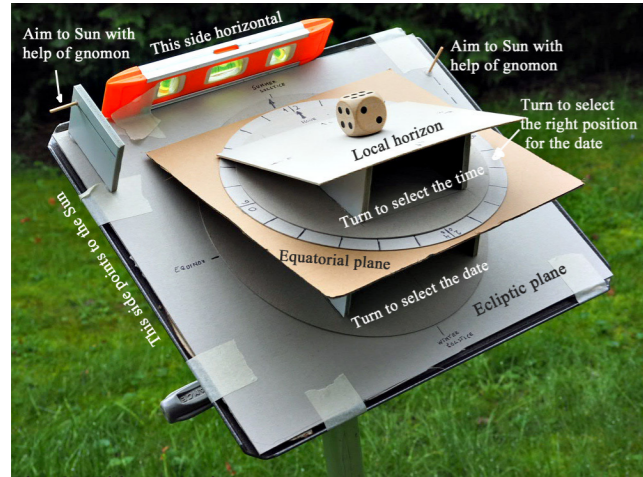

Fig. 67: Ekko, Sakari



Fig. 68: Ekko, Sakari



Fig. 69: Ekko, Sakari

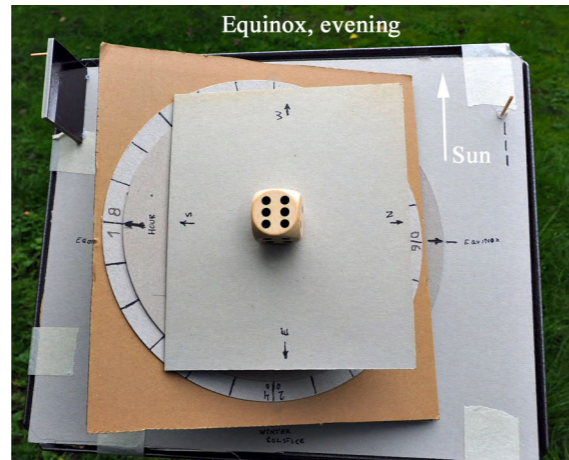

Fig. 70: Ekko, Sakari

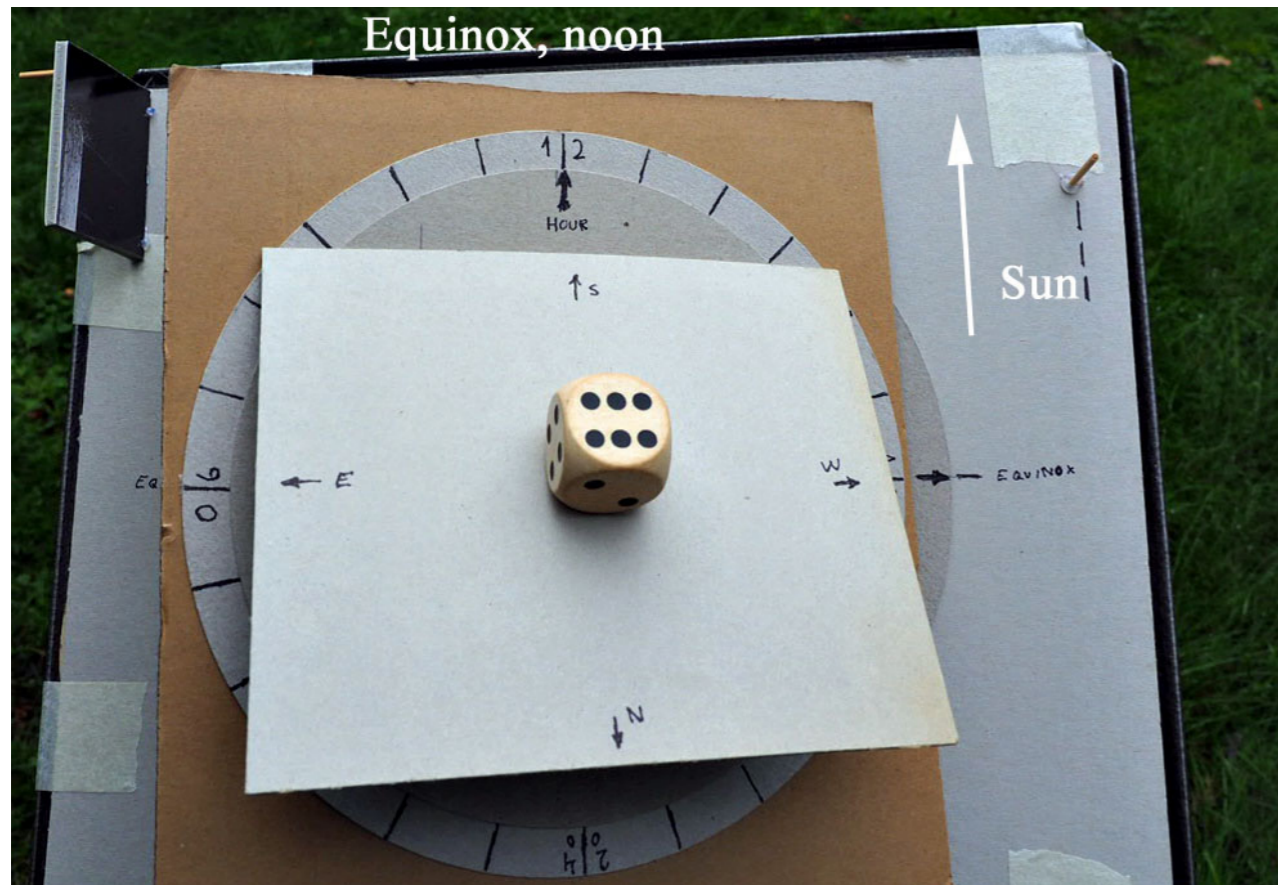

Fig. 71: Ekko, Sakari

2.4 - Heliodon 2 - process - using sun as light source

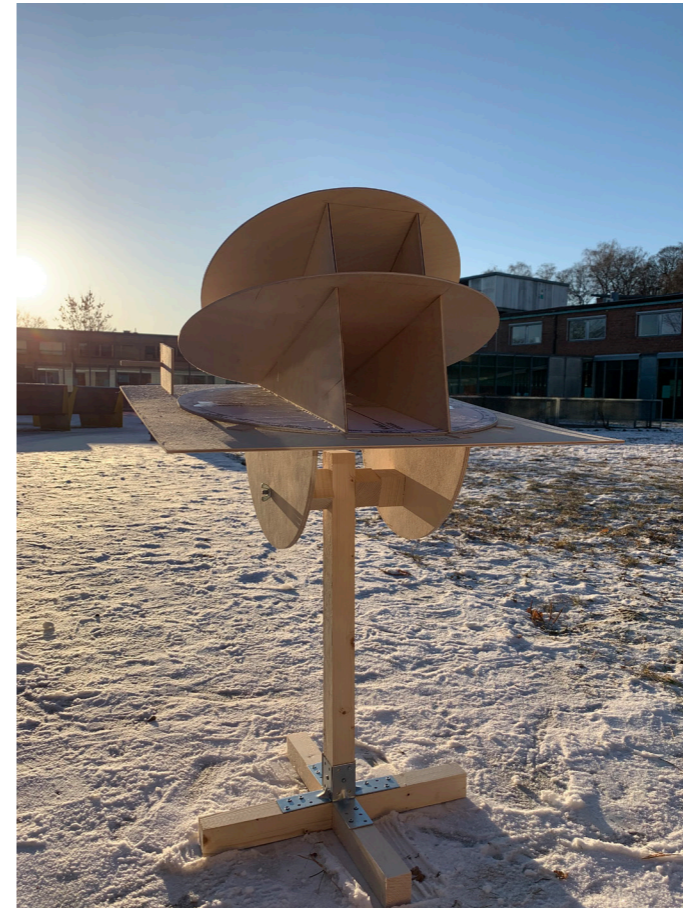

Fig. 72:



Fig. 73:



Fig. 74:



Fig. 75:

Learning from the locals:

56 people took part, anonymously in the survey. They were chosen randomly and are spread all over Tromsø municipality.

DAYLIGHT CONDITIONS IN DWELLINGS

Description: The purpose of the survey is to find out what relationship people of Tromsø have with daylight in their homes. The answers will/can be used to design an architectural proposal at AHO (Arkitektur og Designhøgskolen i Oslo). NB! The answers can/will be published to the public.

1. How long have you lived in the North*?

*By North it means north of BODØ

- Whole life or years: _____

2. How old are you?

- 10-20
- 20-30
- 30-40
- 40-50
- 50-60
- 60-70
- 70+

3. I live in:

- Single-family house
- Semi-detached house
- Terraced house
- Apartment
- Basement flat/apartment
- An annexe
- Other

4. How long have you lived in your current home?

- Whole life or years: _____

5. How satisfied are you overall with the daylight conditions in your home?

Dissatisfied Slightly satisfied Neutral Satisfied Very satisfied Don't know

6. How satisfied are you with the daylight conditions in your home during:

Winter:	<input type="radio"/>	<input type="radio"/>	<input type="radio"/>	<input type="radio"/>	<input type="radio"/>	<input type="radio"/>
	Dissatisfied	Slightly satisfied	Neutral	Satisfied	Very satisfied	Don't know
Spring:	<input type="radio"/>	<input type="radio"/>	<input type="radio"/>	<input type="radio"/>	<input type="radio"/>	<input type="radio"/>
	Dissatisfied	Slightly satisfied	Neutral	Satisfied	Very satisfied	Don't know
Summer:	<input type="radio"/>	<input type="radio"/>	<input type="radio"/>	<input type="radio"/>	<input type="radio"/>	<input type="radio"/>
	Dissatisfied	Slightly satisfied	Neutral	Satisfied	Very satisfied	Don't know
Autumn:	<input type="radio"/>	<input type="radio"/>	<input type="radio"/>	<input type="radio"/>	<input type="radio"/>	<input type="radio"/>
	Dissatisfied	Slightly satisfied	Neutral	Satisfied	Very satisfied	Don't know

7. Does dark-period have a negative effect on your circadian rhythm*?

*Circadian rhythms are physical, mental, and behavioral changes that follow a 24-hour cycle.

Completely agree Partially agree Neutral Partially disagree Completely disagree Don't know

8. Does the midnight-sun have a negative effect on your circadian rhythm?

Completely agree Partially agree Neutral Partially disagree Completely disagree Don't know



Fig. 76:



Fig. 77:

9. Which room is your favorite room in your home?

Room: _____ Don't know

Can you briefly elaborate on why?

Claim: Daylight is an important factor in why this is my favorite room.

Completely agree Partially agree Neutral Partially disagree Completely disagree Don't know

10. Which room do you feel least comfortable in?

Room: _____ Don't know

Can you briefly elaborate on why?

Claim: Daylight is an important factor in why this room is the least comfortable room to be in.

Completely agree Partially agree Neutral Partially disagree Completely disagree Don't know

11. Where do you spend the most time in your home?

Room: _____ Don't know

Can you briefly elaborate on why?

12. What light do you like to wake up to in your bedroom? Make a circle around your answer

Direct sunlight Indirect sunlight Electric light/lamp No light Don't know

Can you briefly elaborate on why?

13. What light do you like to fall asleep to in your bedroom? Make a circle around your answer

Direct sunlight Indirect sunlight Electric light/lamp No light Don't know

Can you briefly elaborate on why?

14. Other things you want to add in relation to daylight in your home:

Map of Tromsø showing areas surveys were gathered from
 In order to make the results as representative as possible i tried to collect information by walking around several neighborhoods where the light conditions are experienced differently due to external factors such as; buildings, vegetation, rocks etc.

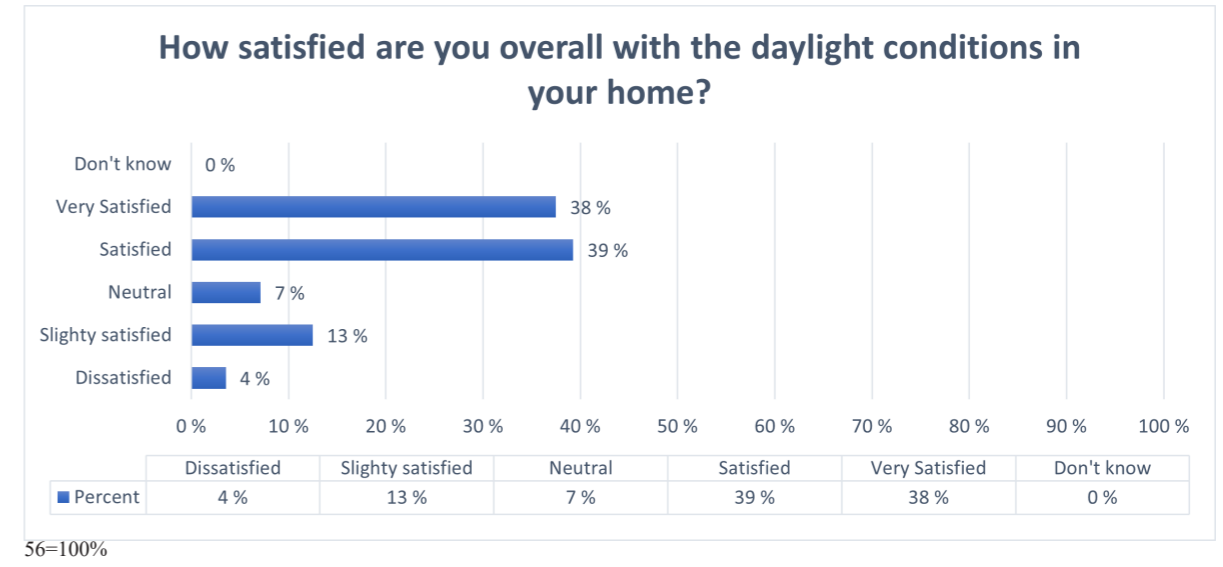
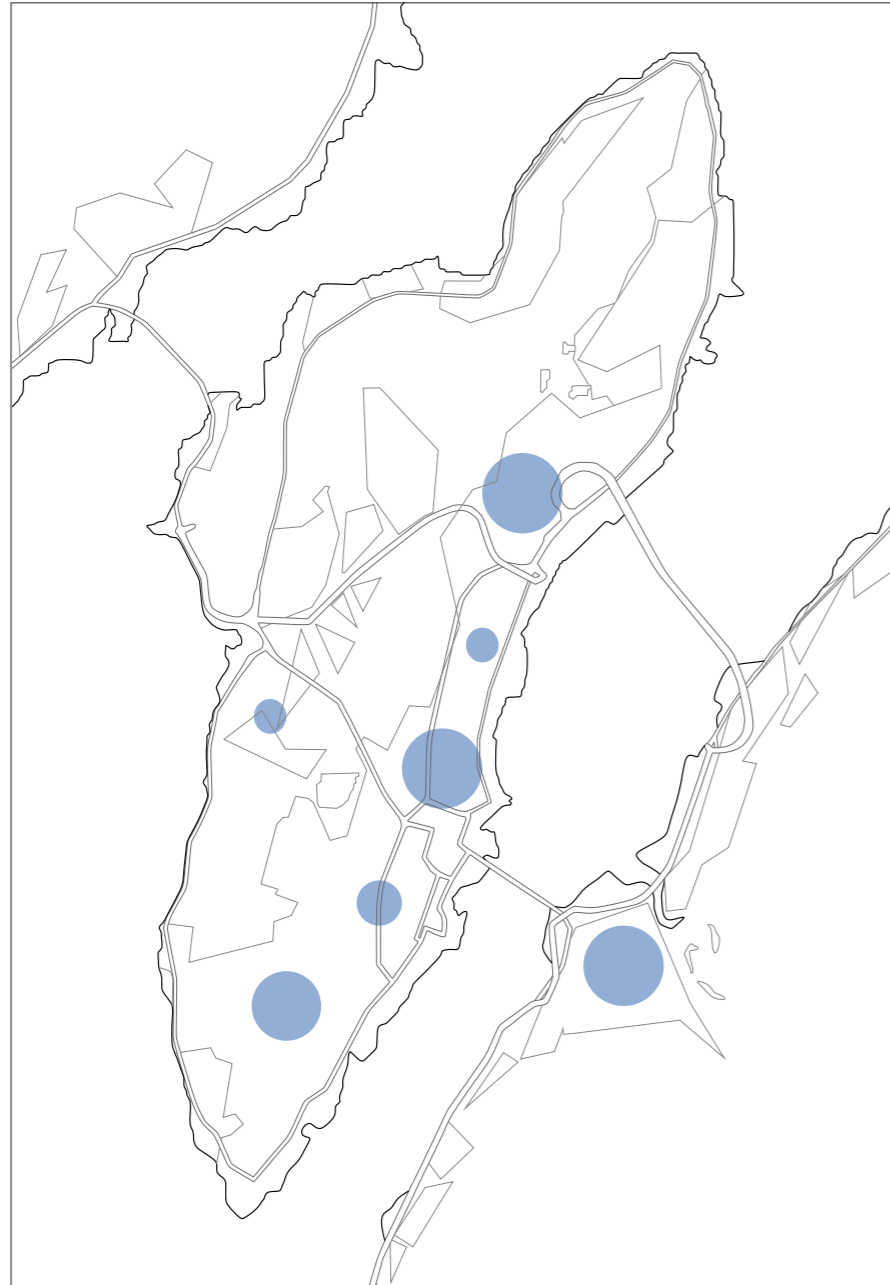

How satisfied are you overall with the daylight conditions in your home?

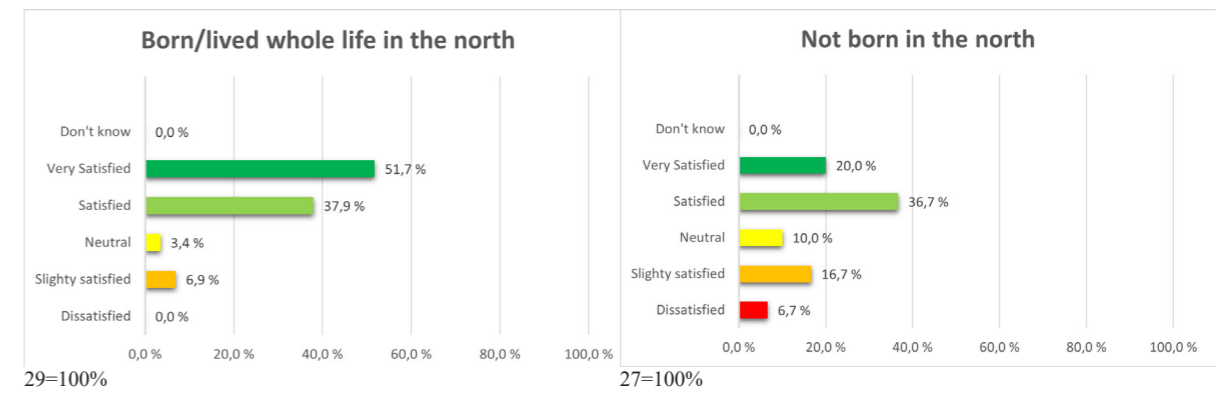

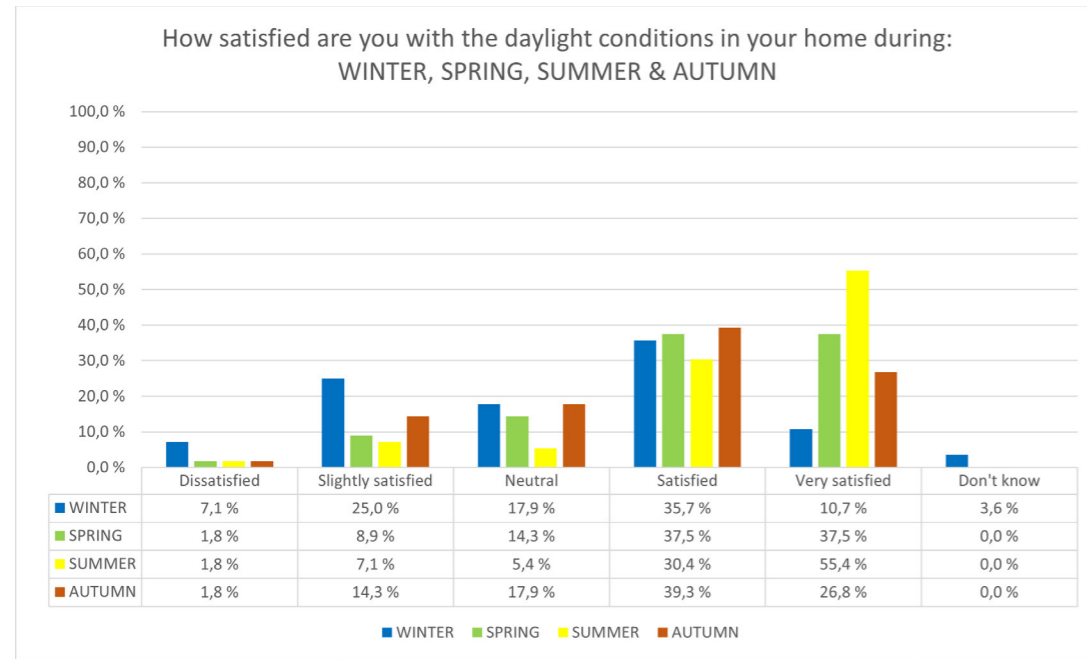

56=100%

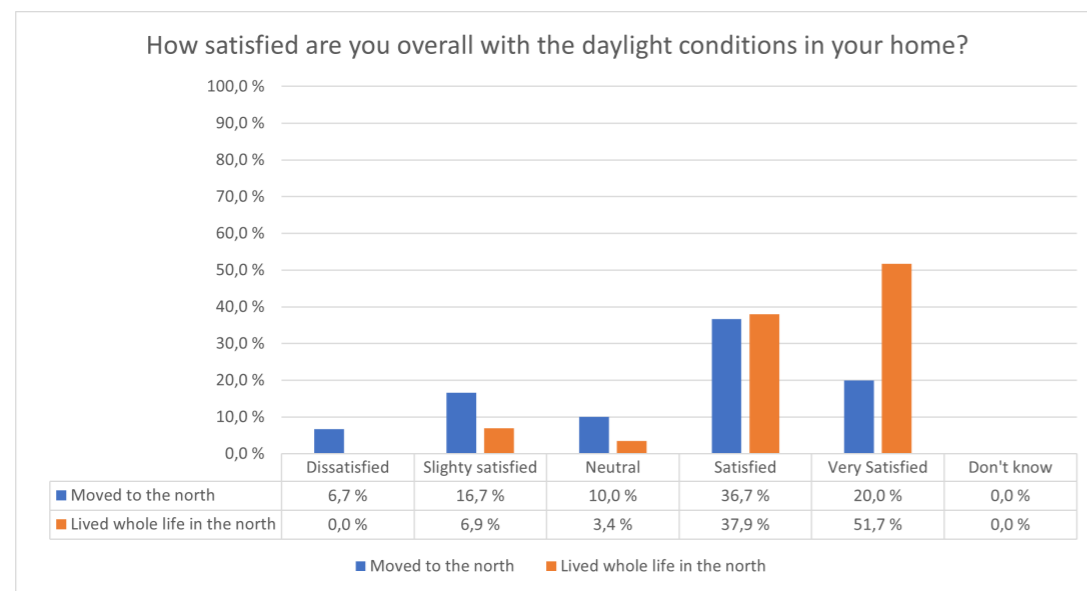

29=100% + 27=100%

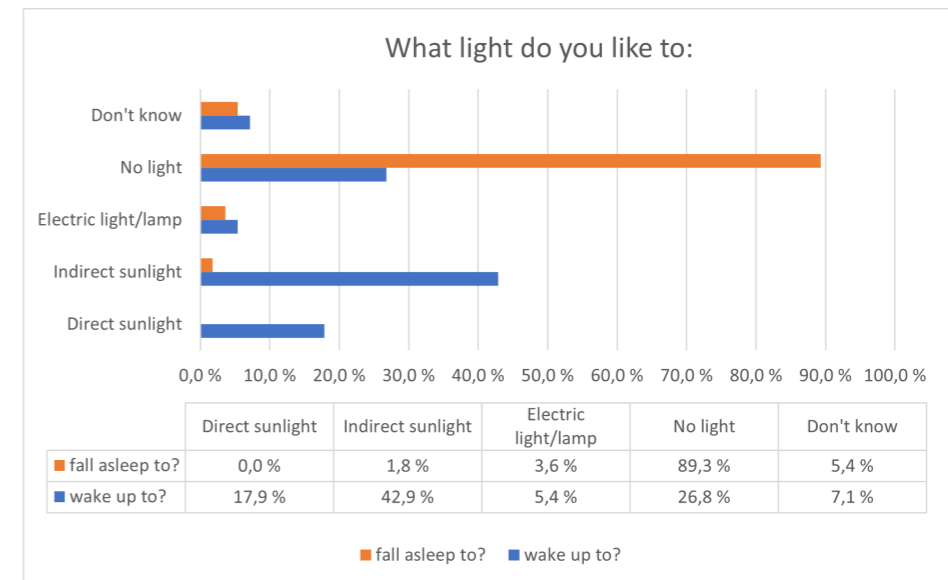

56=100%

Results illustrate how most of the people (89,3%) prefer to fall asleep when there is no light at all in their bedroom. Based on the importance a window and daylight is given to the bedroom by the respondents it is natural to think that specific shading system - for instance a manual or automatic curtain - could solve that issue. Can this be solved through architecture? Maximizing daylight input into the bedroom during the dark-period and opposite during the summer, keeping the sun and light away from it to create a pleasant environment to sleep in and at the same time creating calm, and pleasant light to wake up to in the morning.

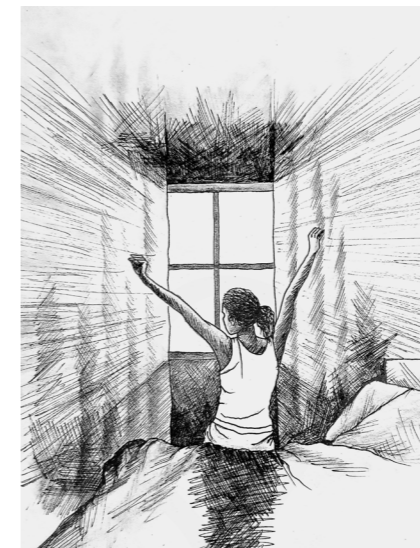
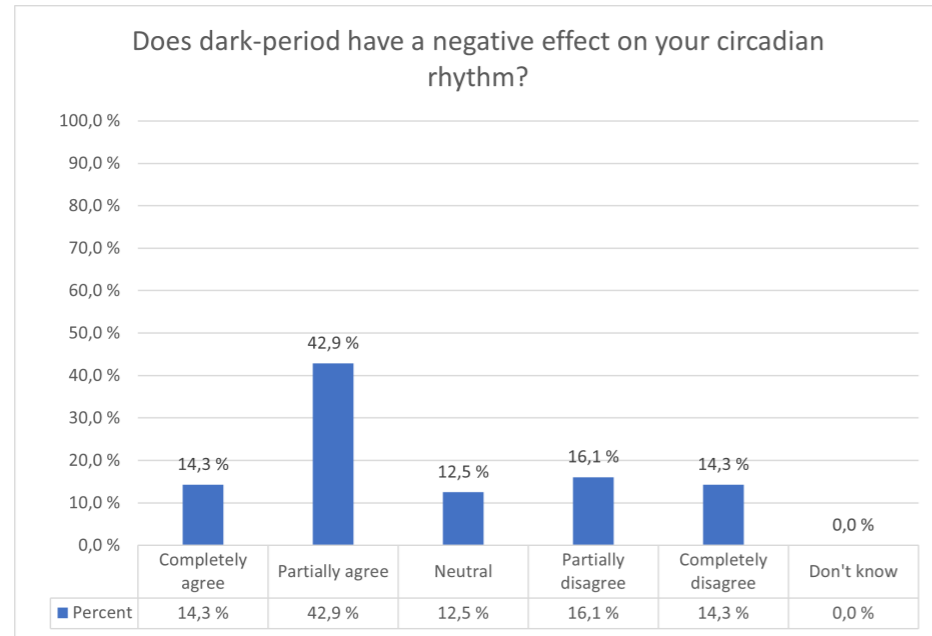

Fig. 78:



Fig. 79:



56=100%

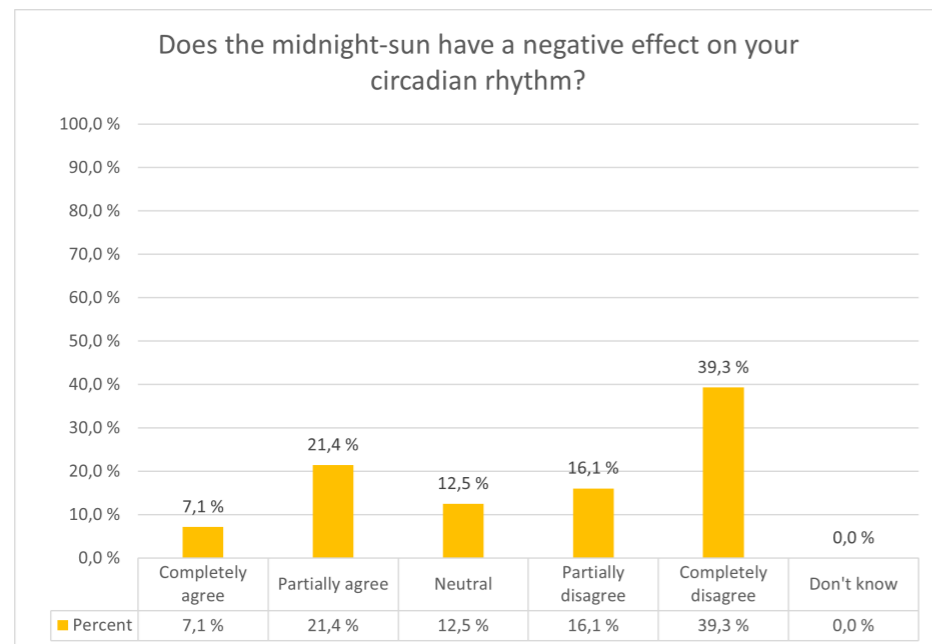

56=100%

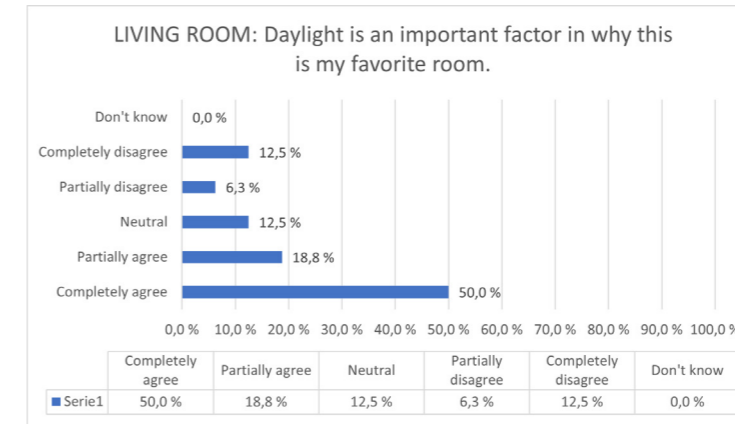
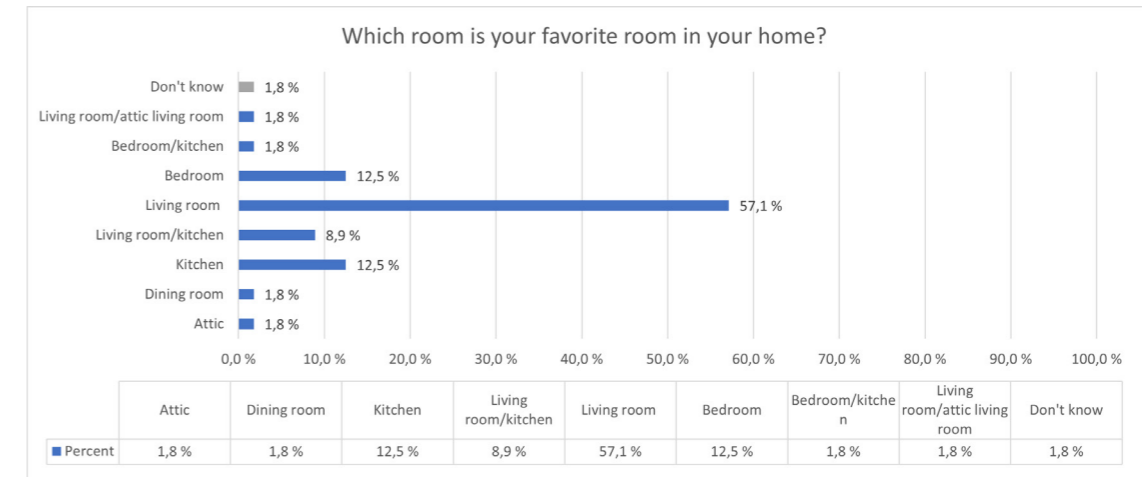

Living room is the most favorite room for 57.1% of the respondents. 50% completely agree on term: Daylight is an important factor in why this is my favorite room, while another 18,8% answer that they partially agree on that. This illustrates the importance daylight has for our experience of a space and the atmosphere it creates. As mentioned in the diagram: "What light do you like:" the idea here will be to create a space that could bring orange, purple, red and blue colors of the sky during the darkest period within Arctic-Norway inside the spaces people value the most and spend most of their time in.

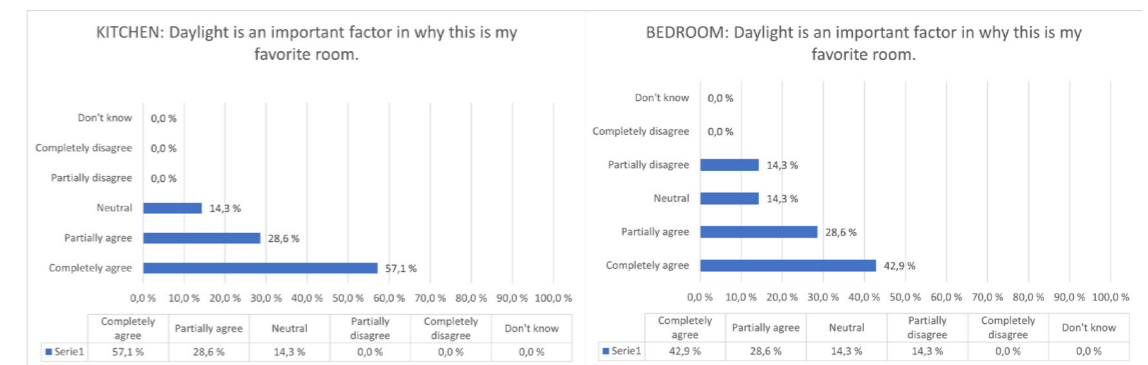

Note! English translation may vary in representation of specific norwegian words.

Question to respondents: Which room is your **favorite room** in your home? and your elaboration on why?

”Stua: Utsikten, roen - sosiale hyggelige møter.”
(Living room: View, calm - pleasant social encounters.)

”Kjøkken: Der samles vi i familien og med venner/naboer. Viktigste sosiale rommet”
(Kitchen: We gather there as a family, with friends/neighbours. The most important social room)

”Stue: Utsikt, lysforhold”
(Living room: View, light conditions)

”Stue+kjøkken: Lys, utsikt, romslig”
(Living room+kitchen: Bright, view, spacious)

”Stue: Mange vinduer”
(Living room: Many windows)

”Medierommet: Stedet hvor det er en del medier som TV-skjerm”
(Media room: A place where there are medias, such as a TV-screen)

”Stue: Liten kjellerleilighet på 36 m2. Stua er størst og har en stol og sofa”
(Living room: Small basement apartment of 36 m2. The living room is the largest and has a chair and sofa)

”Loftet: Der har jeg sminkebordet mitt med bra belysning (lampe)”
(Attic: I have my dressing table there with good lighting (lamp))

”Stua/kjøkken: stort og lyst”
(Living room/kitchen: large and bright)

”Stue: ÅPENT, LUFTIG, LYST, DER JEG TILBRINGER MEST TID”
(Living room: OPEN, AIRY, BRIGHT, WHERE I SPEND MOST OF MY TIME)

”Stua: Størrelsen på rommet, og mulighet for forskjellige aktiviteter”
(Living room: The size of the room, and possibility for having different activities)

”Soverom: fin utsikt og har terrasse”
(Bedroom: nice view and has a terrace)

”Stua: Der er flest vindu og der foregår sosialt samvær”
(Living room: Place with the most windows and social gatherings take place there)

”Stue: Mye naturlig lys, fin utsikt, behagelige møbler”
(Living room: Lots of natural light, nice view, comfortable furniture)

”Spisestue: Store vinduer og utsyn”
(Dining room: Large windows and view)

”Stue: Oppholder meg mest der”
(Living room: I spend most of my time there)

”Oppholdsrom: Tilbringer mest tid der og god mulighet for utsyn”
(Living room: Spend most time there and there is good opportunity for view)

”STUEN: VELDIG FIN UTSIKT”
(LIVING ROOM: VERY NICE VIEW)

”Stuen: Det er fint innredet og mye utsikt”
(Living room: It is nicely furnished and has a lot of views)

”Kjøkkenet: Behagelig...”
(Kitchen: Comfortable...)

”Kjøkken: liker å lage mat”
(Kitchen: I like to cook)

”Stua/kjøkken: Det er det største og lyseste rommet”
(Living room/kitchen: It is the largest and brightest room)

”Soverom: Mørkt, kjølig og rolig del av huset”
(Bedroom: Dark, cool and quiet part of the house)

”Soverom/kjøkken: Kjøkkenet har stort vindu mot vest”
(Bedroom/kitchen: The kitchen has a large window towards west)

”Soverom: Rolige farger, avslappende”
(Bedroom: Calm colors, relaxing)

”Soverommet: Lunt, mørkt, malt tak og vegger”
(Bedroom: Warm, dark, painted ceiling and walls)

”Soverommet: Da en får dagslys direkte på seg om morgen, i sommeren”
(Bedroom: When you get direct daylight on you in the morning, during summer)

”Soverommet: Stort vindu, mer lys og ”hjemmekoselig” + bra utsikt med vinduen!”

(Bedroom: Large window, more light and ”home-cozy” + good view from the window!)

”STUE: Store vindu, 3 stk - utsikt har/Fjell”

(Living room: Large windows, 3 has view/Mountains)

”Stua: Store vindu rett ut mot Rystraumen, lyst og fint”

(Living room: Large windows straight out onto ”Rystraumen”, bright and nice)

”STUE: mest åpent rom. morgensol gjennom vinduer”

(Living room: most open space. morning sun through windows)

”Stue/kjøkken: Vindu mot Sør og Nord (og de er stor) = gjennomlys!”

(Living room/kitchen: Windows to the South and North (and they are large) = light through the whole room!)

”Stue: lys fra 3 sider”

(Living room: light from 3 sides)

”kjøkken: Lyst og åpent”

(kitchen: bright and open)

”kjøkken: liker å lage mat”

(kitchen: I like to cook)

”Stue: TV”

(Living room: TV)

”Stua: åpent rom, det mest naturlige rommet i huset å oppholde seg i”

(Living room: open space, the most natural room in the house to stay in)

”Stua: Plass til det mest nødvendige, spisebord, skrivebord, sofagrupper”

(Living room: Space for the most essential things, dining table, desk, sofa group)

”Stue: TV, sofa”

(Living room: TV, sofa)

”Stue: Der man er mest, har besøk osv.”

(Living room: Where you are the most, have visitors etc.)

”Stue: koselig sted, sofa, TV (atmosfære)”

(Living room: cozy place, sofa, TV (the atmosphere))

”Stue: Store vinduer. Ser utover.”

(Living room: Large windows. Can look out)

”Stue: Den er stor og har sofa”

(Living room: It is large and has a sofa)

”Kjøkkenet: Et samlingspunkt”

(Kitchen: A point of gathering)

”stue/kjøkken: Husets ”hjerte”, der folk er mest”

(Living room/kitchen: The ”heart” of the house, where most people are)

Question to respondents: Which room is your **favorite room** in your home? and your elaboration on why?



2.5 - Interview locals - statistics

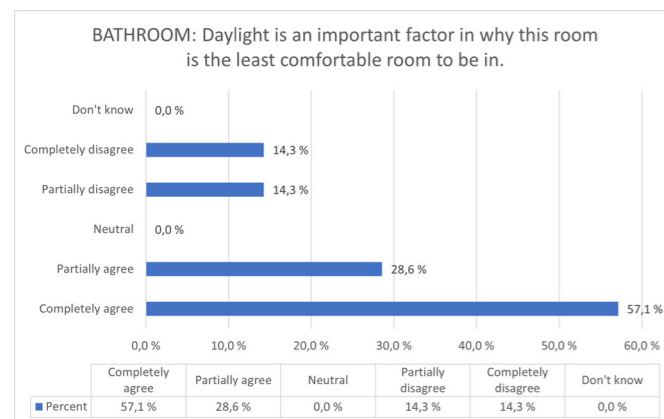
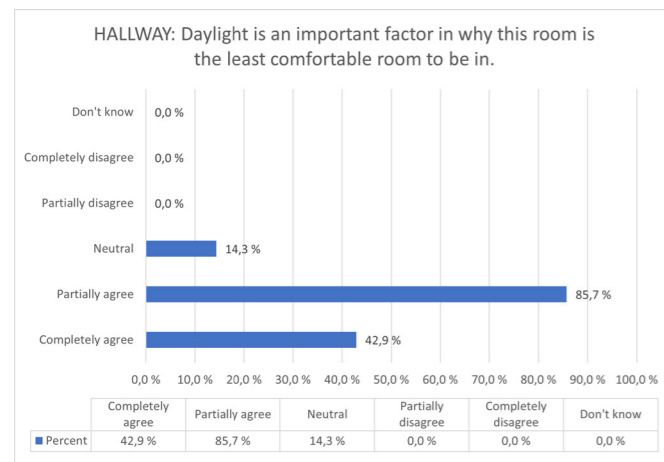
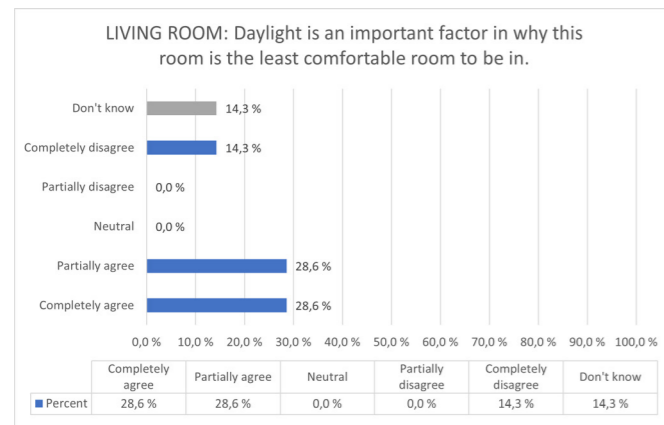
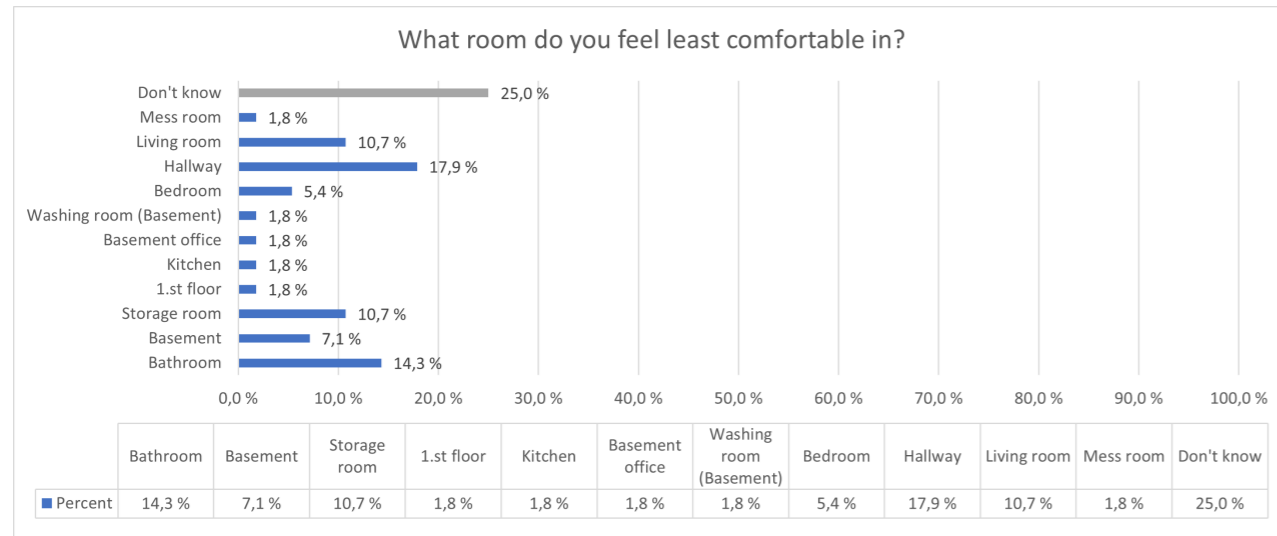

2.5 - Interview locals - statistics

Question to respondents: Which room do you feel **least comfortable** in? and their elaboration on why?

”Badet: For lite”
(Bathroom: Too small)

”Badet: uten vindu”
(Bathroom: without a window)

”Bad: Lite, mørkt”
(Bathroom: Small, dark)

”Badet: Litt lite og ingen vindu :(”
(Bathroom: A bit small and no windows :)

”BAD: Ingen vinduer”
(Bathroom: No windows)

”Badet: Lite lys. Ingen vindu”
(Bathroom: Little light. No windows)

”WC: uten vindu”
(WC: without a window)

”Stuen: Mørkt og dystert, mindre koselig å være der”
(Living room: Dark and gloomy, less pleasant to be there)

”Stuen: Da det er for dystert, vinduet slipper ikke inn nok lys”
(Living room: As it is too gloomy, the window does not let in enough light)

”Stuen: for lite dagslys iforhold til hva jeg ønsker”
(Living room: too little daylight compared to what I wish)

”Stue: Mye støy fra veggen”
(Living room: A lot of noise from the wall)

”Stue: Vindu mot fjellvegg, veldig mørkt”
(Living room: Window facing rock wall, very dark)

”Stua: For store vindu & dårlig belysning”
(Living room: Too big windows & bad lighting)

”Gangen: Mørkt, trangt, rotete”
(Hallway: Dark, cramped, messy)

”Gangen: mørk, ikke vindu”
(Hallway: dark, no window)

”Gangen: trang og dårlig belysning”
(Hallway: cramped and bad lighting)

”Gangen: kjedelig innredet, mørkt”
(Hallway: dull decor/furnished, dark)

”GANGEN: INGEN VINDUER”
(HALLWAY: NO WINDOWS)

”Ganger/korridorer: Så bortkastet areal”
(Hallways/corridors: Such a waste of space)

”Kjøkkenet: ikke et vindu”
(Kitchen: no window)

”1. etg: lavt under taket, lite dagslys...”
(Ground floor: low ceiling, little daylight...)

”Soverom: Det minste soverommet er lite, lite dagslys, liten utsikt”
(Bedroom: The smallest bedroom is small, little daylight, little view)

”Soverommet: Om vinteren pga søvnvansker”
(Bedroom: In winter due to sleep difficulties)

”Gjestebad: Blir brukt som bod. Rotete. Ingen vindu”
(Guest bathroom: Is used as a storage room. Messy. No window)

”Boden: Litt trangt og tett luft”
(Storage room: A bit cramped and dense air)

”BOD: LITE LYS, DÅRLIG VENTILASJON, TRANGT”
(STORAGE ROOM: LITTLE LIGHT, BAD VENTILATION, CRAMPED)

”Boden: ikke vindu”
(Storage room: no window)

”Boden: Fordi der har vi skjeggkre LOL”
(Storage room: Because there we have gray silverfish LOL)

”Bøttekottet: lite plass, ingenting å gjøre der utenom hente saker”
(Storage room: little space, nothing to do there except pick up things)

”kjellerkontoret: Det er mørkere der”
(basement office: It's darker there)

”kjeller: lite lys”
(basement: little light)

”kjelleren: Stusselig”
(basement: Boring)

”kjeller: Mørk, innerst i kjeller, lite vindu (1stk)”
(basement: Dark, deep in the basement, small window (1))

”kjellerrom: ikke utsikt, lite lys”
(basement: no view, little light)

”Mellomgang/gang: Her er det ikke vinduer”
(Aisle/hallway: There are no windows here)

”Yttergangen: Mørk, rotete”
(Outer hallway: Dark, messy)

Question to respondents: Which room do you feel **least comfortable** in? and their elaboration on why?

TOO SMALL LITTLE LIGHT
DARK BATHROOM MESSY
NO WINDOW

CRAMPED NO WINDOW
BAD LIGHTING HALLWAY MESSY DULL DECOR
DARK WASTE OF SPACE

LITTLE SPACE
CRAMPED DENSE AIR
LITTLE LIGHT STORAGE ROOM
NO WINDOW BAD VENTILATION

2.6 - Interview professionals & history

Based on my discussions regarding topic of daylight in architecture in Northern-Norway I will highlight the most important phrases that came up during my interviews/dialogs with architects. Their insights that are relevant for the project I wish to include in the design process.

N.B. Unfortunately due to lack of formal papers the information is presented anonymously and represents architects in Northern-Norway as a group of professionals.

Architect 1&2

- Get light in and look out
- Have a possibility to observe light for 24h
- Get windows up to the slab
- The view is important
- Sun hits horizontally here, be aware of the heating
- Little legislation relating to daylight
- Indirect daylight - light from the North is important
- Dark-period is not dark, because there is snow here. A lot of free light from the snow.
- Other types of colors - extended sunrise/sunset
- Pink and orange sky, how get this special light inside?
- Get the qualities from all celestial directions

Architect 3

- Daylight conditions in northern Norway are not reflected in the regulations
In that sense, the architecture between North and South is quite similar
- Spring - mentally, the amount of light increases rapidly in the North. There is an abrupt transition from dark-period to summer time
- Snow on the ground in winter. Large amounts of snow in Tromsø. The light is reflected from the snow into the house
- Much stronger sense of gray darkness in cities. In southern Norway, the feeling is greater than in the north
- Lift the window up. not such a big financial burden
- The sun is at about 43 degrees above the horizon at its highest in the summer in Tromsø, keep that in mind
- 2 am : Sun enters the bedroom = hot and bright
- Play with sun and shadows, the height of windows. Different heights and locations of them.
- " We can not be indifferent to light "
- There has been no awareness of daylight
- The social aspect was important in the design
- Economy
- After 2WW : There were no larger windows, it was difficult to produce them. They cost a lot of money.
One went for standardized windows for the most part.

Architect 4

Took me on a sightseeing trip around the city showcasing projects by architects that has worked with light. Shared a lot of interesting facts and history of Tromsø related to topic of my diploma.

2.6 - Interview professionals & history

In the book "Den norske byggeskikken" we get a glimpse of the past with different practices in architecture of dwellings. "Årestue" a building typology that was primarily used around year 1700, both summer and winter. A centered open fireplace was the most important and vital part of the dwelling where people often gathered around or prepared their food. Above the fireplace due to ventilation issues as there were no pipes or windows an opening was located directly above the fireplace, called "ljore" which can be translated to "light". These were the only light sources within a house available at that time.⁴

Later on through time the development of the fireplace with pipes could lead the smoke to the outdoor, that changed completely how a house could be designed. From one floor "årestue" to two storey high structures with more openings or windows. Despite these changes the windows were very expensive at that time and not many could afford them.⁵ In most cases the main light source were still the fireplace. Eventually due to technological development other types of light sources were accessible, like the kerosene lamps.

After the industrialization started the electricity became more and more part of the organization of the floor plan. The fireplace was no longer mainly working as a light source but to warm up the house, while the artificial light slowly lit up the spaces.⁶



Fig. 80: Anders Askevold, *Interior fra en årestue*, Askevold, Anders. Maleri 1875. Nasjonalmuseet. 09.12.23, <https://www.nasjonalmuseet.no/samlingen/objekt/NG.M.01821>

4 Arne Lie Christensen, *Den norske byggeskikken, Hus og bolig på landsbygda fra middelalder til vår egen tid* (Oslo: Pax, 1995) 156-157

5 Christensen, *Den norske byggeskikken*, 160

6 Christensen, *Den norske byggeskikken*, 178-184

2.6 - Interview professionals & history

Emails between author of this thesis and Direktoratet for byggkvalitet (Directorate for Building Quality in Norway)

Hei!

Jeg er en arkitektstudent ved AHO (Arkitektur og Design høyskolen i Oslo). Jeg forsker på dagslysforhold i eneboliger nord for polarsirkelen til masteroppgaven min høsten 2023. Jeg har noen spørsmål jeg håper dere kan besvare.

Norge er et langt land og grunnet sin geografiske lokasjon opplever ekstreme* variasjoner i dagslysforhold gjennom året. Dette vises/oppleves alle tydeligst nord for polarsirkelen (Troms&Finnmark og nordlige delen av Nordland).

1. Hva er bakgrunnen til at forskriften 13-7. - Lys omhandler slik jeg forstår det hele landet, til tross for store kontraster i dagslysforhold gjennom året mellom Nord og Sør Norge?

2. På nettsiden deres skriver dere følgende; ”Dagslys er den belyningsformen som vanligvis oppleves å være den beste og mest viktige allmennbelysningen”. Burde ikke det da stilles helt andre krav til dagslysinnslipp i boliger oppført i Nord for å maksimere denne belyningsformen (gjelder hovedsakelig vinterstid)?

3. Har denne problemstillingen vært drøftet tidligere?

Mvh David Pedersen

Reflection note: As it comes from the feedback I got from the Directorate for Building Quality in Norway the regulations regarding access to daylight are completely equal for the whole country, despite the difference in light conditions Northern-Norway experiences throughout a year, comparing to Southern-Norway. This definitely makes me want to explore more how we can access both more daylight as well as interpret other light phenomenas that occur in the Arctic region of Norway in a new type of dwelling.

Lys og utsyn § 13-7. Lys

Viser til henvendelse om dagslysbestemmelsen for bygninger oppført i Nord-Norge.

I byggt teknisk forskrift reguleres mange fagområder som skal sikre en minimumskvaliteter i byggverk. De fleste kravene er generelle og gjelder likt for hele landet, mens f.eks. konstruksjonssikkerhet er differensiert som følge av blant annet ulike snølaste.

Tematikken du tar opp er kjent. Dagslyskravet i TEK17 gjelder generelt for hele landet. Bakgrunnen for at regelverket er slik det er, kjenner jeg ikke til. Jeg vil anta at dette har vært politisk drøftet og konkludert en gang for mange år siden.

Endringer i regelverket er relativt omstendelige prosesser som normalt må konsekvensutredes, høres mm, og hvorvidt dagens innretning bør endres eller ikke skal ikke jeg konkludere noe om. Vi tar med oss innspillet i den videre utviklingen av regelverket.

- - -

Direktoratet for byggkvalitet svarer på spørsmål om forståelsen av byggt teknisk forskrift (TEK), byggesaksforskriften (SAK) og forskriften om produkt-dokumentasjon (DOK), men vi kan ikke vurdere konkrete byggesaker, byggeprosjekter, løsninger eller tegninger.

Har du spørsmål om saksbehandling av en konkret byggesak, må du kontakte kommunen din.

Direktoratet for byggkvalitet

N.B. Personal information in connection with the email has been removed and refers to the Directorate for Building Quality as the source.

<https://www.dibk.no/regelverk/byggt teknisk-forskrift-tek17/13/v/13-7>

2.7 - Case studies

GRØNNEGATA 21-23



Fig. 81: Groven, Harald, *Grønnegata 21-23, Tromsø*, https://no.wikipedia.org/wiki/Gr%C3%B8nnegata_%28Troms%C3%B8%29#/media/Fil:Gr%C3%B8nnegata_21-23,_Troms%C3%B8.JPG

Architect: Blå Strek arkitekter AS

- Program: 3 Family houses, dormitory building, NRL
- Sami center/office
- Location: Tromsø, Norway
- Year: 1986
- Material/s: Timber frame, woodwork

<https://arkitekturguide.uit.no/items/show/804>, 31.08.2023

Grønnegata 21-23 is a project originally intended to be a transformation-project, ended up being a new built with an intention of creating more living spaces in the area. The plot is located in the historical quarter structure part in the city center of Tromsø, characterised by typical wooden two storey high townhouses, rich in detailing and use of colors. Most of the buildings in this area stands wall to wall giving access to daylight either from above or from two of the four facades in most cases. The building that I'm focusing on in this case study is the Sami-center that has one facade facing towards the courtyard (SE) and one towards the street (NW). The architect behind the project intended to design these buildings by developing and reinterpreting existing structures with a touch of adding new elements to the design. The placement of the windows, their size and amount of them where important in order to bring daylight to all the spaces and floors within the building. By looking at the facade drawings we can see that they may appear chaotically placed in the facade⁷

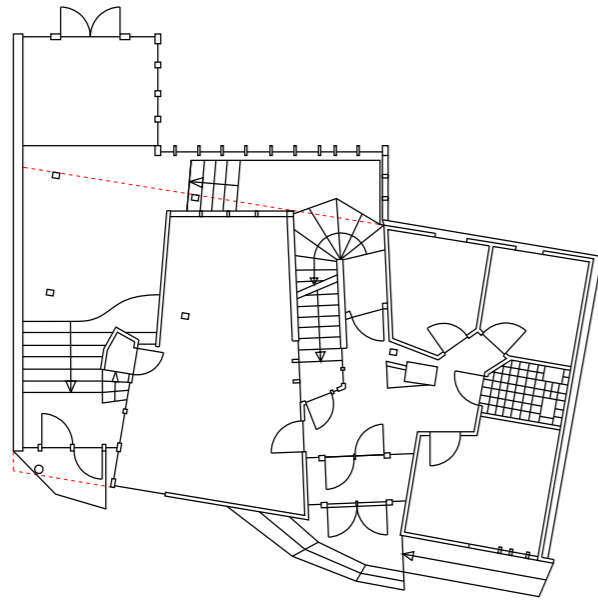

Underground
SCALE 1:200

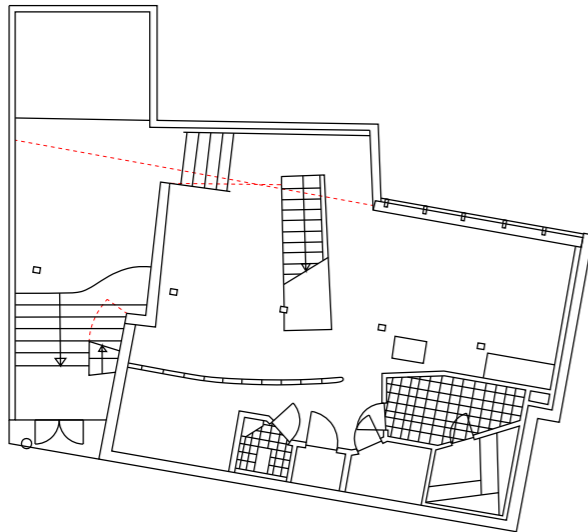

1 Floor
SCALE 1:200

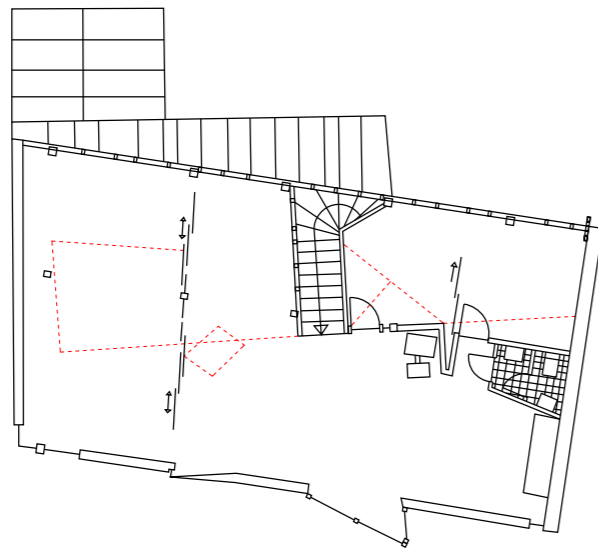

2 Floor
SCALE 1:200

POINT OF INTEREST: FACADE, WINDOWS

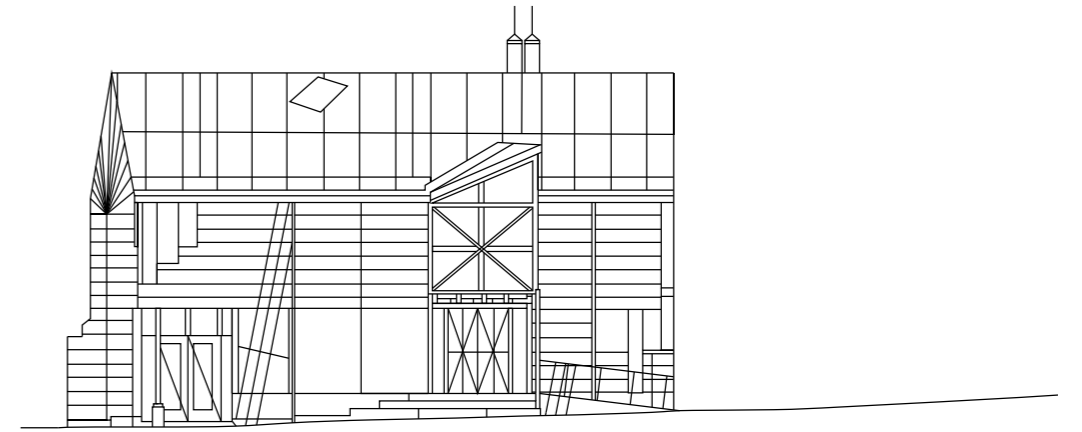

Facade exposed to: W, NW, N

SCALE 1:200

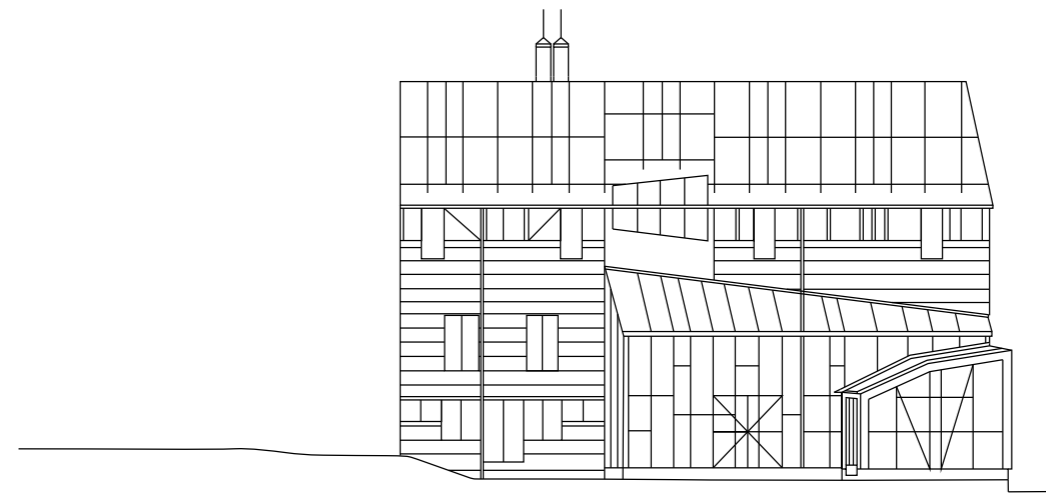

Facade exposed to: E, SE, S

SCALE 1:200

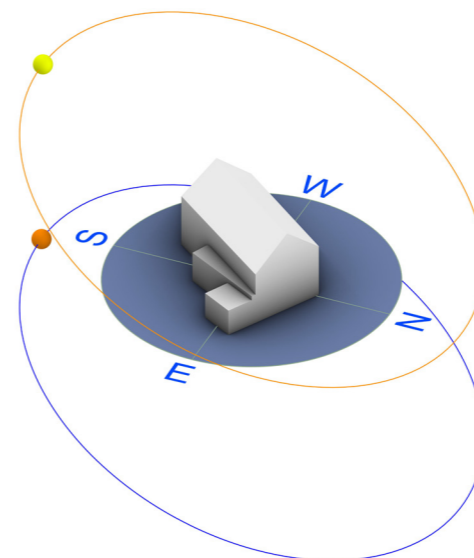

3D model of the building illustrating polar - day and night conditions on site.

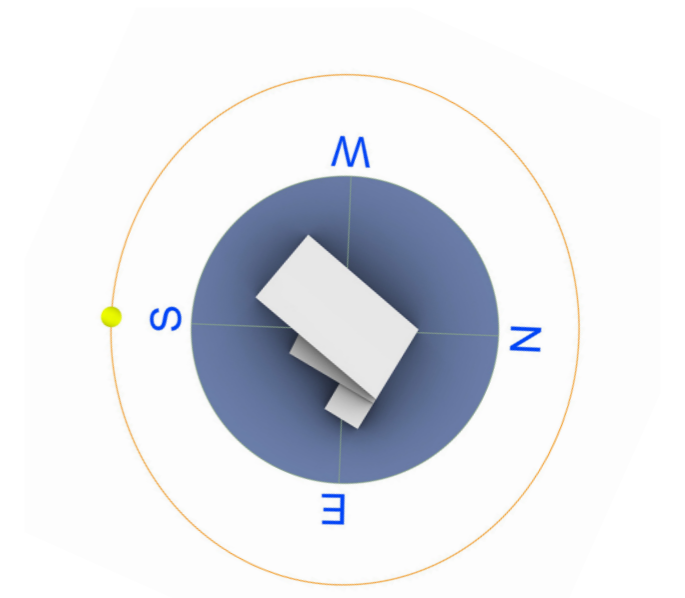

Plan of the 3D model.

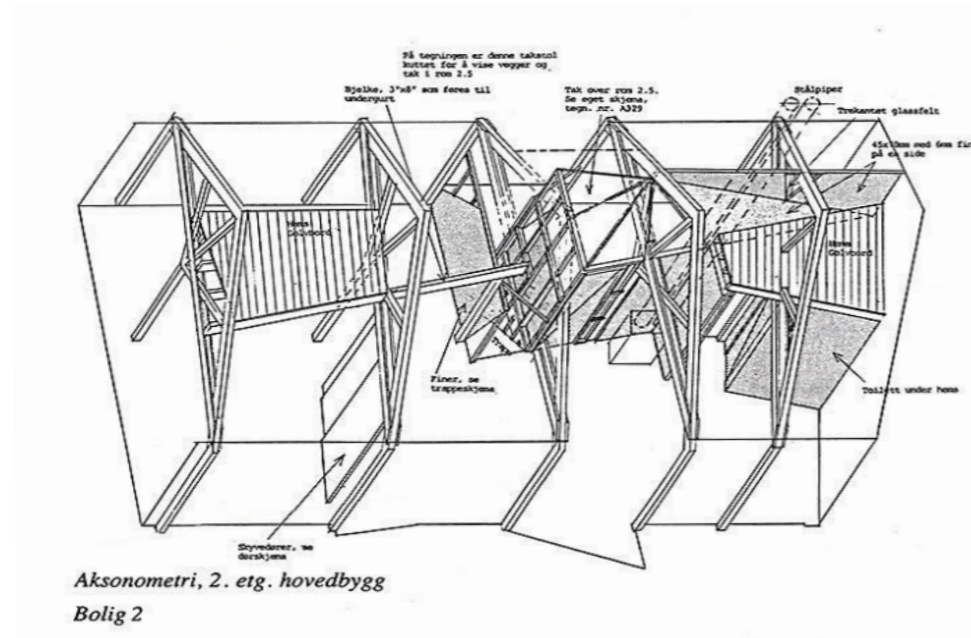
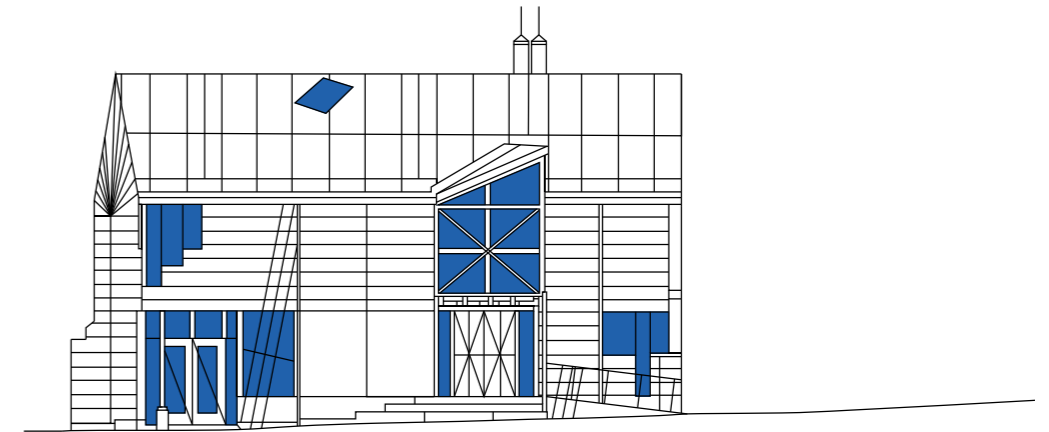

Fig. 82:

<https://old.arkitektur-n.no/prosjekter/grønnegata-21-23-tromsø>
 READ 31.08.2023



Facade (street view): Distribution of the windows

SCALE 1:200

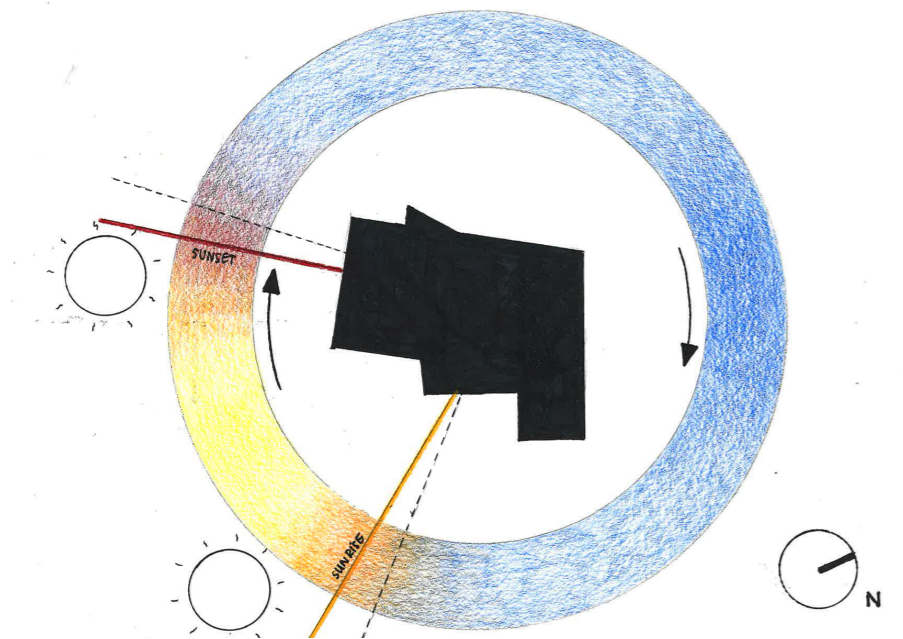

18. OCTOBER

<https://shademap.app/@69.64691,18.9517,17.74377z,16976278576,48t,0b,0p,0m!NaN!NaN,qRILDMESORUdBVEEgMjMgdHJvbXP-DuA=!69.64693!18.95155>
 READ 18.10.23

Reflection note: Due to the sun being low on the horizon most of the time during a year, never raising above 43 degrees in Tromsø, it is more sensful to work with light entering the spaces along the facades. Grønnegata 21-23 showcases that with the distribution of the windows, its placement and angles. I would like to include these thoughts further into design process along with the idea of building something new and respecting the existing language of the context

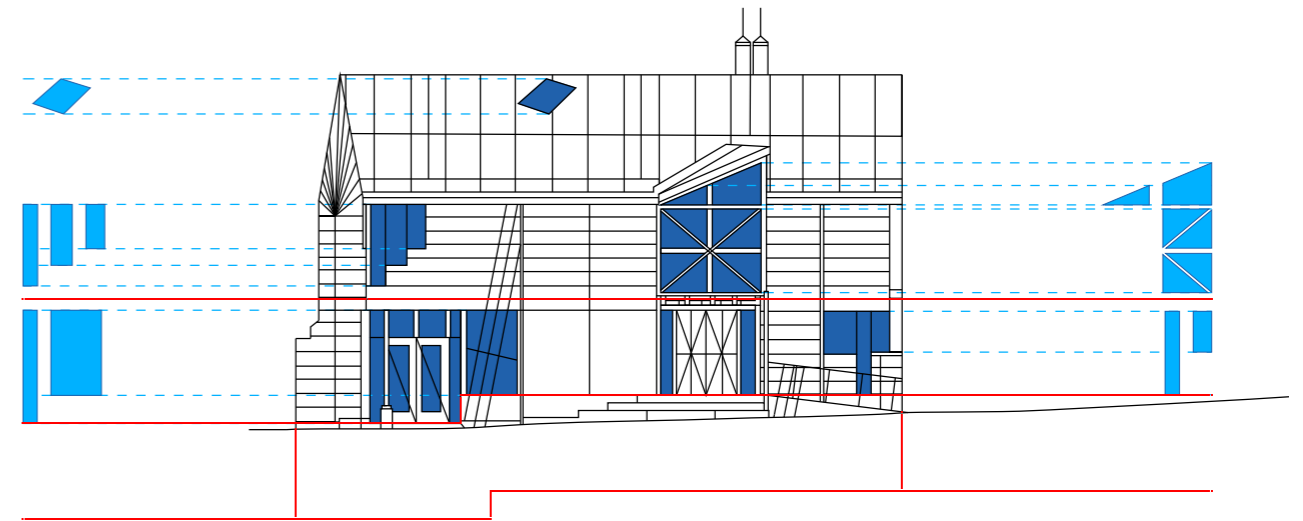

Facade (street view):

SCALE 1:200



Facade (court yard view): Distribution of the windows

SCALE 1:200

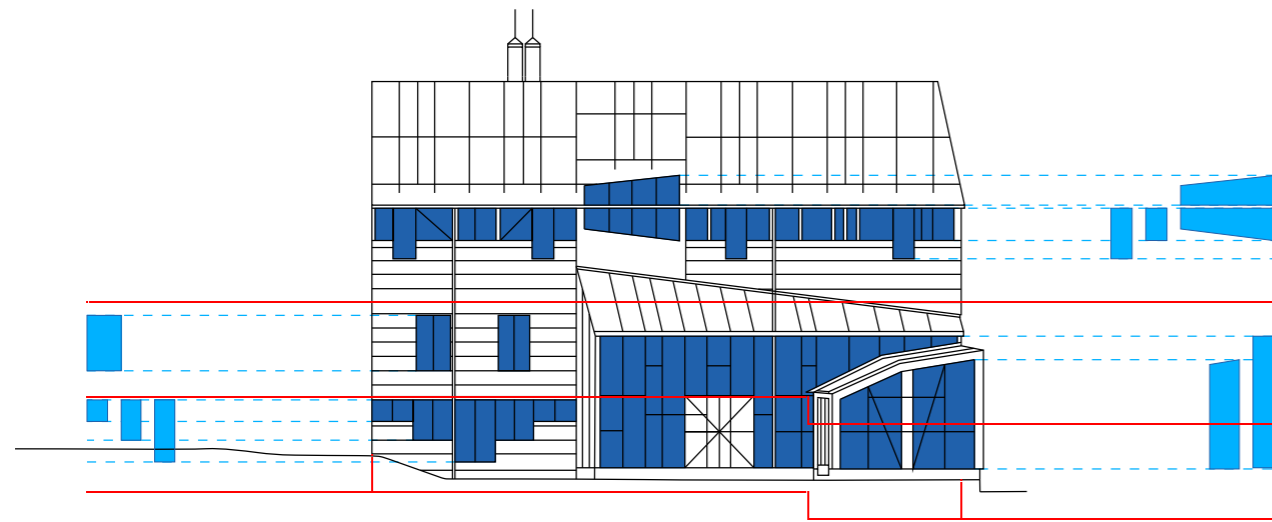

Facade (court yard view):

SCALE 1:200

VAN WASSENHOVE HOUSE



Fig. 83: Guillaume BXL, <https://hicarquitectura.com/2023/07/juliaan-lampens-villa-van-wassenhove-1973/>

Architect: Juliaan Lampens

- Project completed in 1973

- Sint-Martens-Latem, Belgium

- Materials: Concrete, wood, glass

<https://divisare.com/projects/373601-juliaan-lampens-jeroen-verre-cht-van-wassenhove-house>, 24.09.2023

Project Villa Van Wassenhove is a house that works with the base of free floor plan. The program within the interior spaces are defined by several geometrical shapes to highlight specific functions; round shaped bedroom as an example.⁸

⁸ Hidden Architecture, <<Villa Van Wassenhove>>, by Hidden Architecture, 09.12.23. <https://hiddenarchitecture.net/villa-van-wassenhove/>

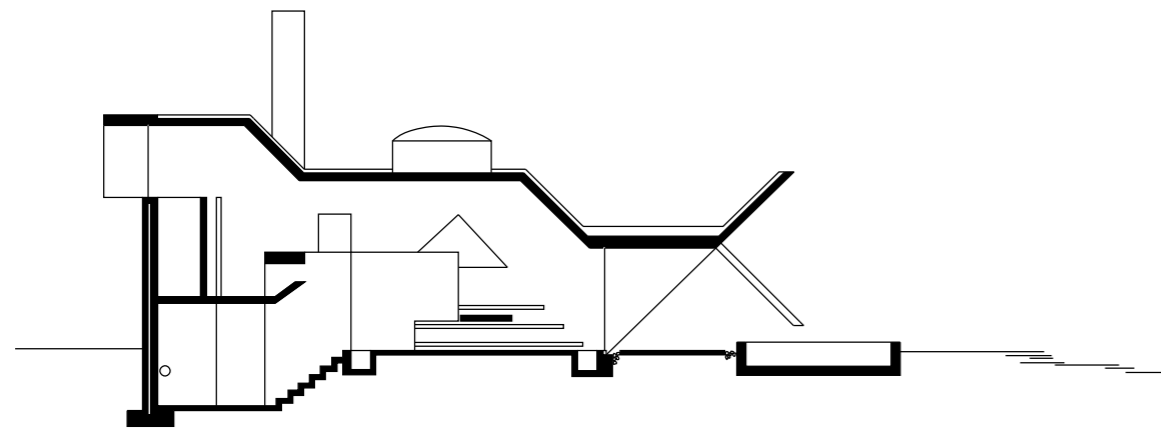

SCALE 1:100

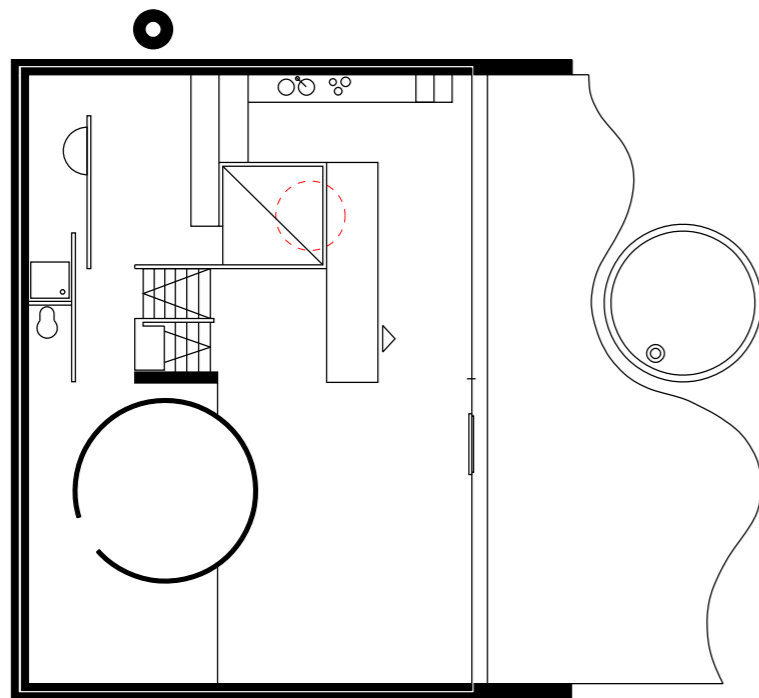

SCALE 1:100



POINT OF INTEREST: OPEN PLAN FLOOR PLAN

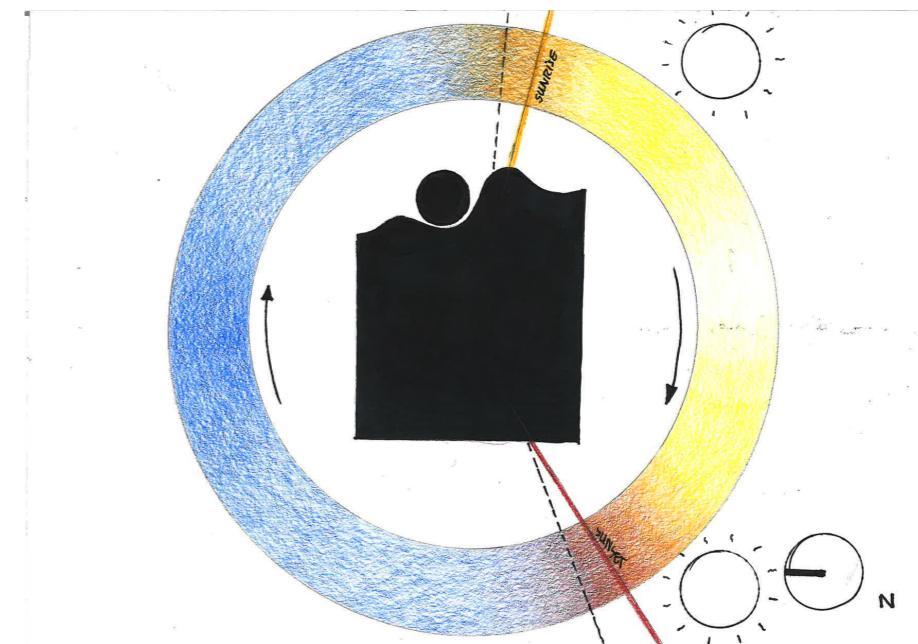
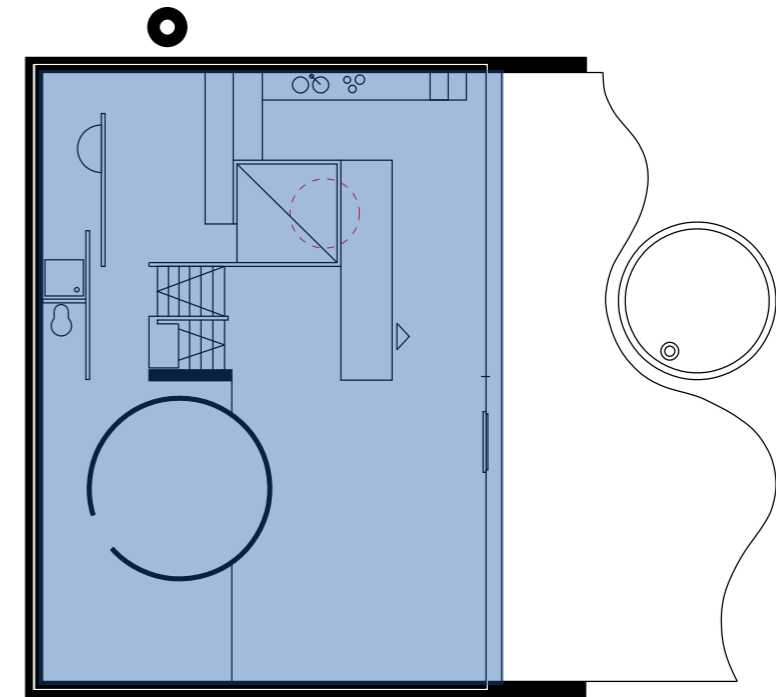

EXAMPLE; 18. OCTOBER

<https://shademap.app/@51.0242,3.61879,18.52421z,1697627857648t,0b,0p,0m!NaN!NaN,qQnJha2Vsc3RyYWF0IDU-wLCA5ODMwIFNpbmQrTWYydGVucy1MYXRibSwgQmVsZ2lh!51.02424!3.61875, 18.10.23>



Fig. 84: Unknown photographer, <https://hiddenarchitecture.net/villa-van-wassenhove/>



Fig. 85: Unknown photographer, <https://hiddenarchitecture.net/villa-van-wassenhove/>

Reflection note: I really like the idea of open floor plan in this project and how different spaces get affected by light. Especially the office area with the light coming from above (circular window, marked red in plan drawing) along with bathroom getting indirect light reflected by the angled roof in Fig. 84. I would like to work with a open floor plan that has a clear language in what the common spaces are and what is private. That being said light will play a leading role in how these spaces will be designed.

La Tourette



Fig. 86: Schapochnik, Fernando, Flickr elyullo (CC BY), Samuel Ludwig, Maria Gonzalez, <https://www.archdaily.com/96824/ad-classics-convent-of-la-tourette-le-corbusier>

Architect: Le Corbusier & assistant Iannis Xenakis

- Project completed in 1959
- France

- Materials: Reinforced unfinished concrete, altar floor of black slate, sprayed and white washed plaster walls, prefabricated pebble-dashed concrete.

Monastery of Sainte Marie de la Tourette is a project located on a hillside in close proximity to the town of Eveux-sur-l'Arbresle in France. It is designed to provide 100 Dominican monks with architecture that Le Corbusier has given individual light qualities to through the whole program of the building. In the introduction of *Cosmos of light*, Henry Plummer says; <<*In these modest religious works Le Corbusier deploys light to create enchanted, emotionally charged spaces wedded to cosmic rhythm of sunlight and season.*>> .⁹ In this analysis I will mainly focus on one specific point of interest which is the Oratory and showcase by drawings and photos how Le Corbusier worked with light and rythm of sun path in this specific part of the Monastery.

⁹ Henry Plummer, *Cosmos of light: The sacred Architecture of Le Corbusier* (Indiana: Indiana University Press, 2013) 71-72

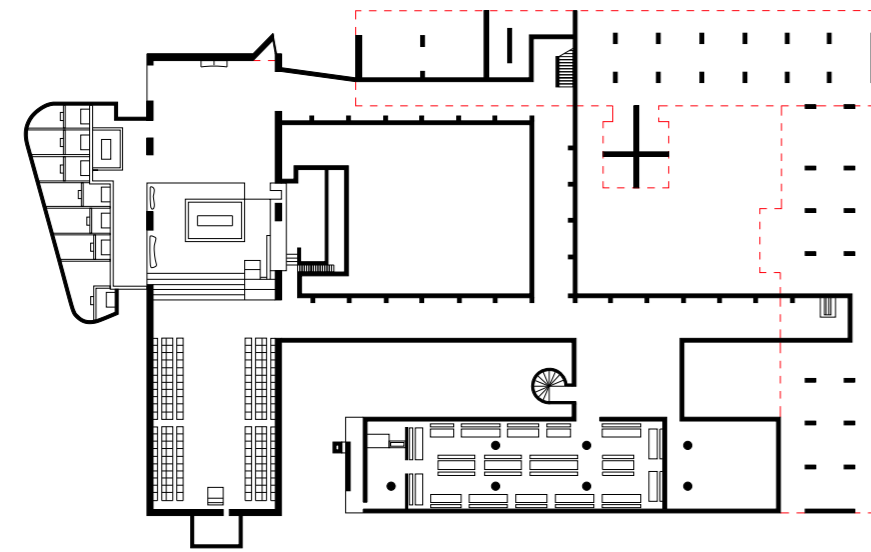

SCALE 1:500

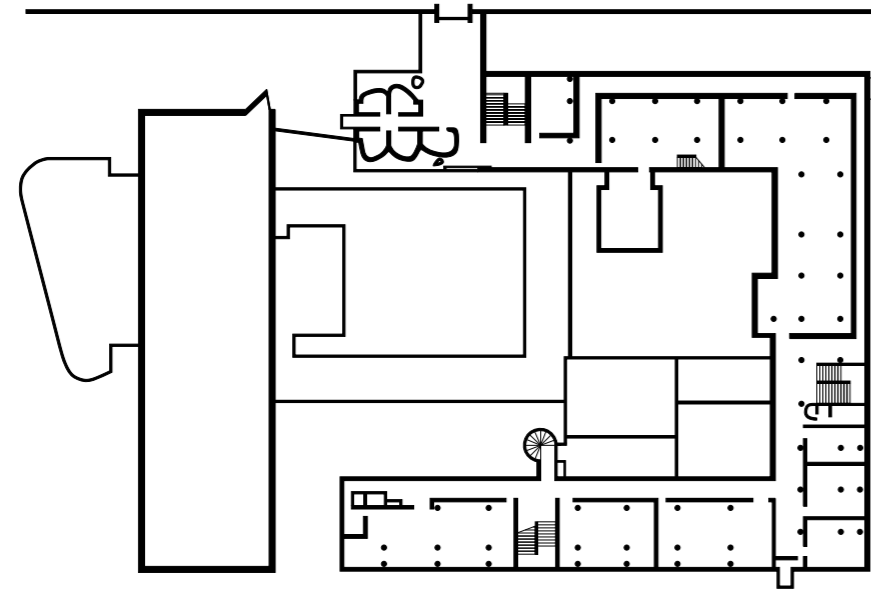

SCALE 1:500

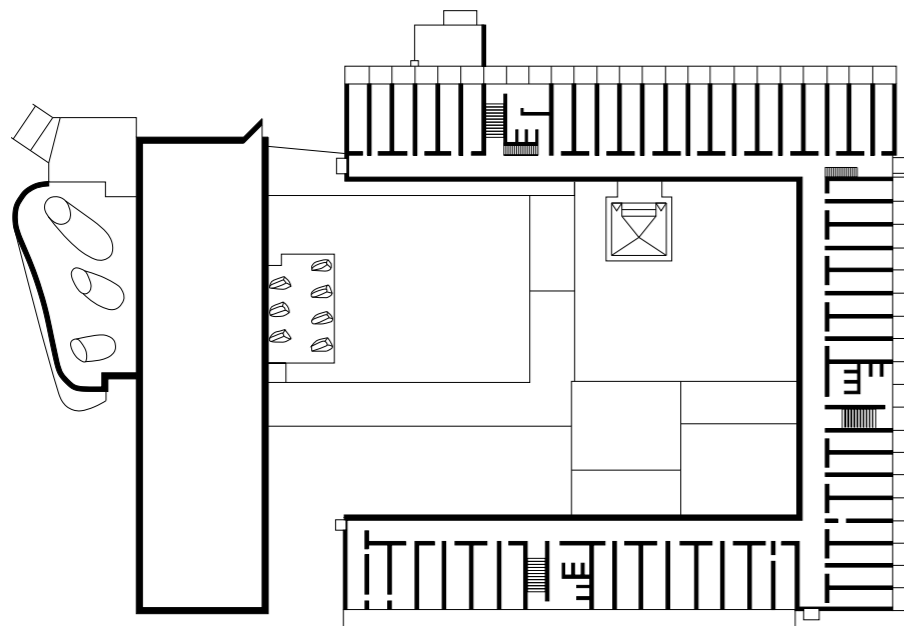

SCALE 1:500

POINT OF INTEREST: LIGHT REFLECTION

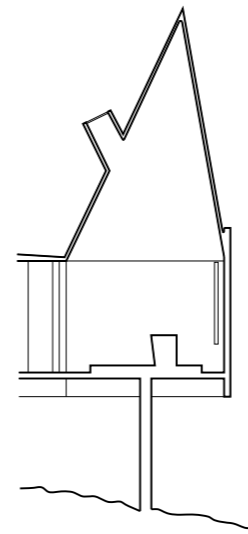

SCALE 1:200

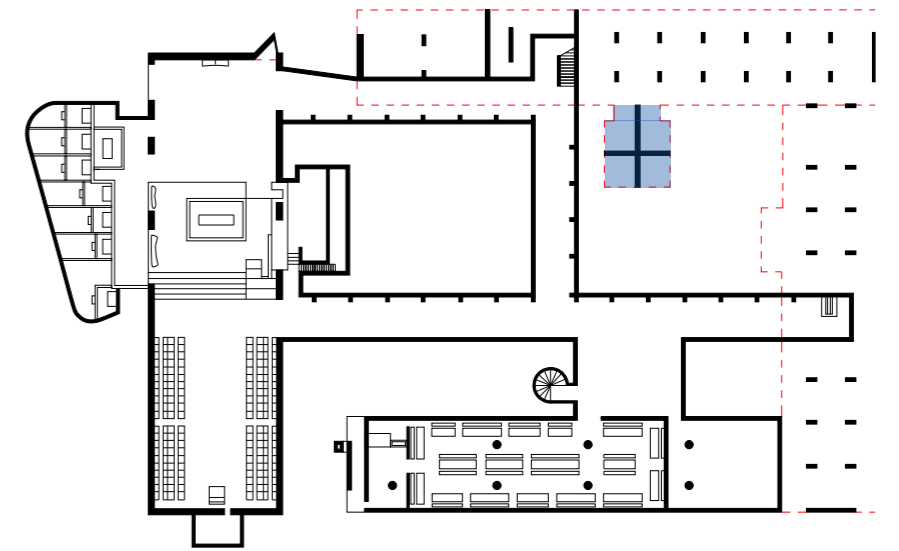

SCALE 1:500



Reflection note: I got very interested in the light reflections in this project. How a small opening (window) can provide calm atmosphere (oratory). Aswell as the materiality and how colors and surface affect how we perceive light in a space.

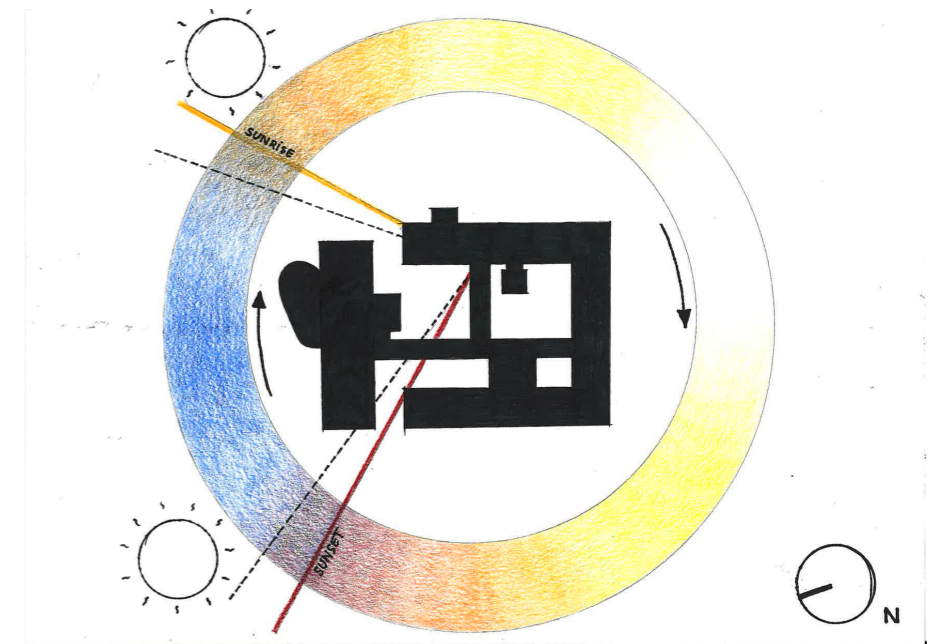

EXAMPLE; 18. OCTOBER

<https://shademap.app/@45.8192,4.62262,17.47089z,1697627857648t,0b,0p,0m!NaN!NaN,qNzYwIFJ0ZSBkZSBsYS-BUub3VyZXR0ZSwgNjkyMTAgw4l2ZXV4LCBGcmFua3J-pa2U=!45.82158!4.62378>
 READ 18.10.23

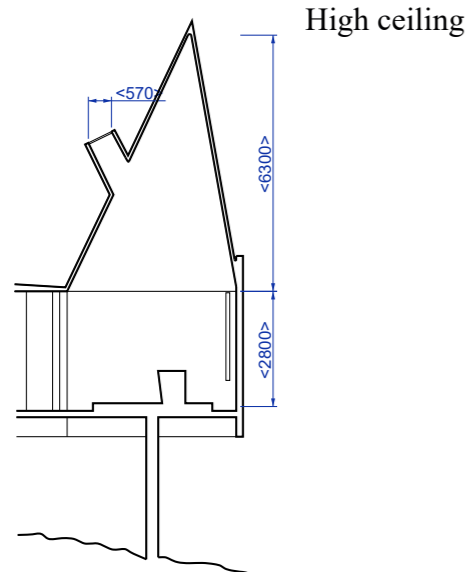

High ceiling



Light entering on a overcast day

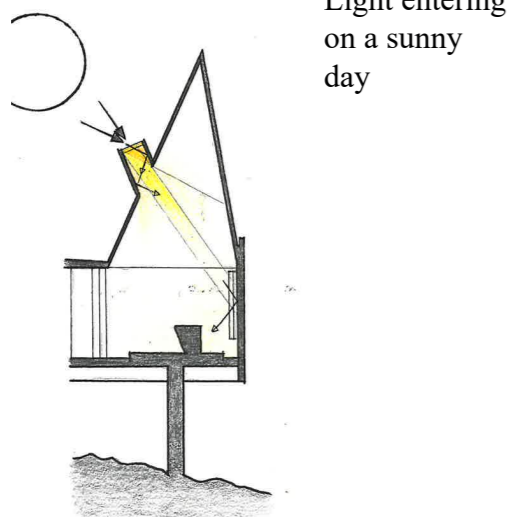

Light entering on a sunny day

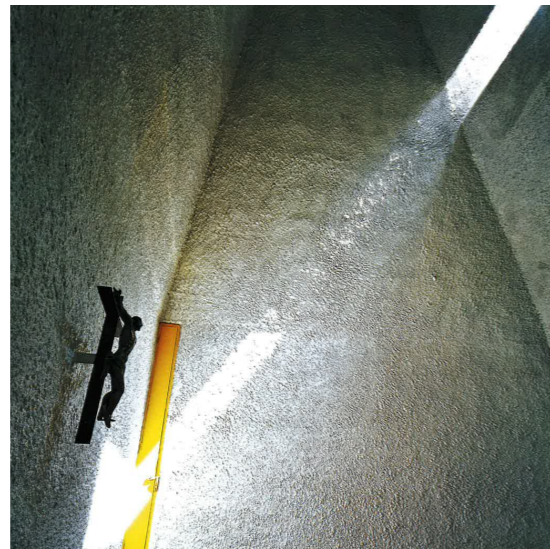
Fig. 87: Unknown photographer, <https://www.architectours.com/tour/la-tourette-corbusier/>Fig. 88: From *Cosmos of light: The sacred Architecture of Le Corbusier*. 98Fig. 89: From *Cosmos of light: The sacred Architecture of Le Corbusier*. 101

Literature and other sources

Hage, Ingebjørg, Haugdal, Elin, Ruud, Bodil, Hegstad, Sveinulf (red). *Arkitektur i Nord-Norge*. Bergen: Fagbokforlaget, 2008.

Hegstad, Sveinulf. *Tromsø: byvandringar*. Tromsø: Tromsø kommune, kulturavd. : Troms fylkeskommune, kulturetaten, 1997, https://urn.nb.no/URN:NBN:no-nb_digibok_2014062406066

Norberg-Schulz, Christian. *Nattlandene: om byggekunst*. Gyldendal, 1993, https://urn.nb.no/URN:NBN:-no-nb_digibok_2011070405028

EndNotes

- 1 Ros M. Rosa, Berthomieu Francis. *Stellar, solar and lunar demonstrator*. International Astronomical Union. Technical University of Catalonia, http://sac.csic.es/astrosecundaria/en/cursos/formato/materiales/conferencias/T2_en.pdf
- 2 Ekko, Sakari. *How to build a big plywood demonstrator*. EAAE Finland. <http://sac.csic.es/astrosecundaria/unawe/en/actividades/instrumentos/plywood.pdf>
- 3 Aschehoug Øyvind, Arnesen Heidi, *Dagslys i bygninger: prosjekteringsveiledning*. Stabekk: Lyskultur, 1998, https://urn.nb.no/URN:NBN:no-nb_digibok_2010042806078
- 4 Christensen Lie, Arne. *Den norske byggeskikken, Hus og bolig på landsbygda fra middelalder til vår egen tid*. Oslo: Pax, 1995.
- 5 Christensen Lie, Arne. *Den norske byggeskikken, Hus og bolig på landsbygda fra middelalder til vår egen tid*. Oslo: Pax, 1995.
- 6 Christensen Lie, Arne. *Den norske byggeskikken, Hus og bolig på landsbygda fra middelalder til vår egen tid*. Oslo: Pax, 1995.
- 7 Blå strek arkitekter Dahl, Hageberg, Mjaaland MNAL. *Byggekunst, The Norwegian review of Architecture, Grønnegata 21-23, Tromsø*. Published on web 30. january 2020. Originally published in *Arkitektur N* nr. 5 - 1985. <https://old.arkitektur-n.no/prosjekter/gronnegata-21-23-tromso>
- 8 Hidden Architecture, <<Villa Van Wassenhove>>. Hidden Architecture, 09.12.23. <https://hiddenarchitecture.net/villa-van-wassenhove/>
- 9 Plummer, Henry. *Cosmos of light: The sacred Architecture of Le Corbusier*. Indiana: Indiana University Press, 2013.

Photos and illustrations

Fig. 1: Pedersen, David, *Paper model of solar demonstrator*.

Fig. 2: Ros M Rosa, Berthomieu Francis, *Stellar, solar and lunar demonstrator*.

Fig. 3: Ekko, Sakari, *How to build a big plywood demonstrator*.

Fig. 4, 5, 6, 7, 8, 9, 10, 11, 12, 13, 14, 15, 16, 17, 18, 19, 20, 21, 22, 23, 25, 26, 27, 28, 29, 30, 31, 32, 33, 34, 35, 36, 37, 38, 39, 40, 41, 42, 43, 44, 45, 46, 47, 48, 49, 50, 51, 53, 54, 56, 57, 59, 60, 62, 63, 64, 65, 72, 73, 74, 75, 76, 77, 78, 79: Pedersen, David

Fig. 24: Babb, David, <https://www.e-education.psu.edu/eme811/node/642>

Fig. 52: timeanddate, <https://www.timeanddate.no/astronomi/sol/norge/oslo>

Fig. 55: timeanddate, <https://www.timeanddate.no/astronomi/sol/@6541314?month=6&year=2023>

Fig. 58: timeanddate, <https://www.timeanddate.no/astronomi/sol/italia/milano?month=6&year=2023>

Fig. 61: Attinà, Luca, *Sun analysis in Milano*

Fig. 66: shademap, read 3.12.2023, <https://shademap.app/@69.64976,19.0285,9.73412z,1695465457648t,-0b,0p,0m!1697695845732!1697726996340,qdHJvbXPDuA==!69.6492!18.95532>

Fig. 67, 68, 69, 70, 71: Ekko, Sakari

Fig. 80: Anders Askevold, *Interiør fra en årestue*, Askevold, Anders. Maleri 1875. Nasjonalmuseet. 09.12.23, <https://www.nasjonalmuseet.no/samlingen/objekt/NG.M.01821>

Fig. 81: Groven, Harald, *Grønnegata 21-23, Tromsø*, https://no.wikipedia.org/wiki/Gr%C3%B8nnegata_%28Troms%C3%B8%29#/media/Fil:Gr%C3%B8nnegata_21-23,_Troms%C3%B8.JPG

Fig. 83: Fig. 83: Guillaume BXL, <https://hicarquitectura.com/2023/07/juliaan-lampens-villa-van-wassenhove-1973/>

Fig. 84: Fig. 84: Unknown photographer, <https://hiddenarchitecture.net/villa-van-wassenhove/>

Fig. 85: Fig. 84: Unknown photographer, <https://hiddenarchitecture.net/villa-van-wassenhove/>

Fig. 86: Schapochnik, Fernando, Flickr elyullo (CC BY), Samuel Ludwig, Maria Gonzalez, <https://www.archdaily.com/96824/ad-classics-convent-of-la-tourette-le-corbusier>

Fig. 87: Unknown photographer, <https://www.artchitectours.com/tour/la-tourette-corbusier/>

Fig. 88: From: *Cosmos of light: The sacred Architecture of Le Corbusier. 98*

Fig. 89: From: *Cosmos of light: The sacred Architecture of Le Corbusier. 101*

3. DEVELOPING THE CONCEPT

- 3.1 - Program
- 3.2 - Sun studies - Heliodon 1
- 3.3 - Sketches - process

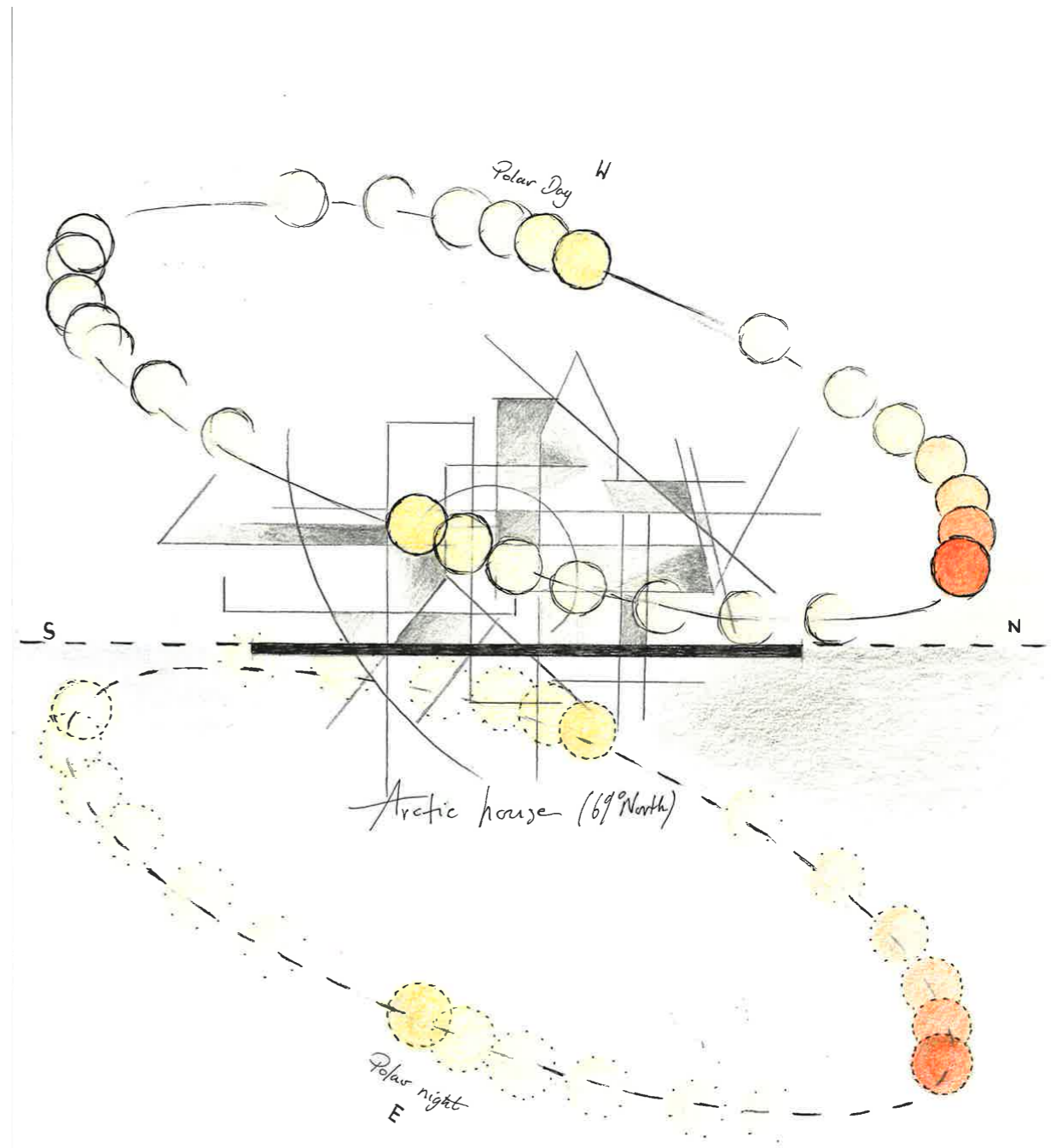

3.1 - Program

- Single family-house
- Around 200 sqm
- Access to daylight in every space
- Max 2/2,5 floors
- Max height 9m-regulations (can be lower depending on context)
- No basement in the ground/ no large excavations on the plot.
- Kitchen
- Living room
- Bedrooms
- Bathroom

*In addition to the base of the program I am including findings from the research that guided development of the project: BLUE colored words are included

SURVEY:

Most favorite rooms + <<Daylight is an important factor in why this is my favorite room>>

- LIVING ROOM
 - LARGE WINDOWS
 - LIGHT CONDITIONS
 - VIEW
 - SPACIOUS
- KITCHEN
 - BRIGHT
 - SOCIAL ROOM
 - LIGHT CONDITIONS
- BEDROOM
 - DARK
 - VIEW
 - RELAXING

Least favorite rooms + <<Daylight is an important factor in why this is my least favorite room>>

- BATHROOM
 - NO WINDOW
 - LITTLE LIGHT
 = WINDOW/S
- HALLWAY
 - NO WINDOW
 - DARK
 - WASTE OF SPACE
 = PART OF OPEN FLOOR PLAN
- STORAGE ROOM
 - CRAMPED
 - NO WINDOW
 - LITTLE LIGHT
 = PART OF OPEN FLOOR PLAN

PROFESSIONALS - ARCHITECTS

- **Observe light 24h**
- **Windows up to the slab**
- **Sun hits more horizontally in the North**
- **Qualities from all celestial directions**
- **Snow and reflection from it**

CASE STUDIES

- **Having windows placed mostly along the facade**
- **Open plan floor**
- **Angles/angled walls**
- **Construction/facade materials reflecting existing architectural language**

3.1 - Program

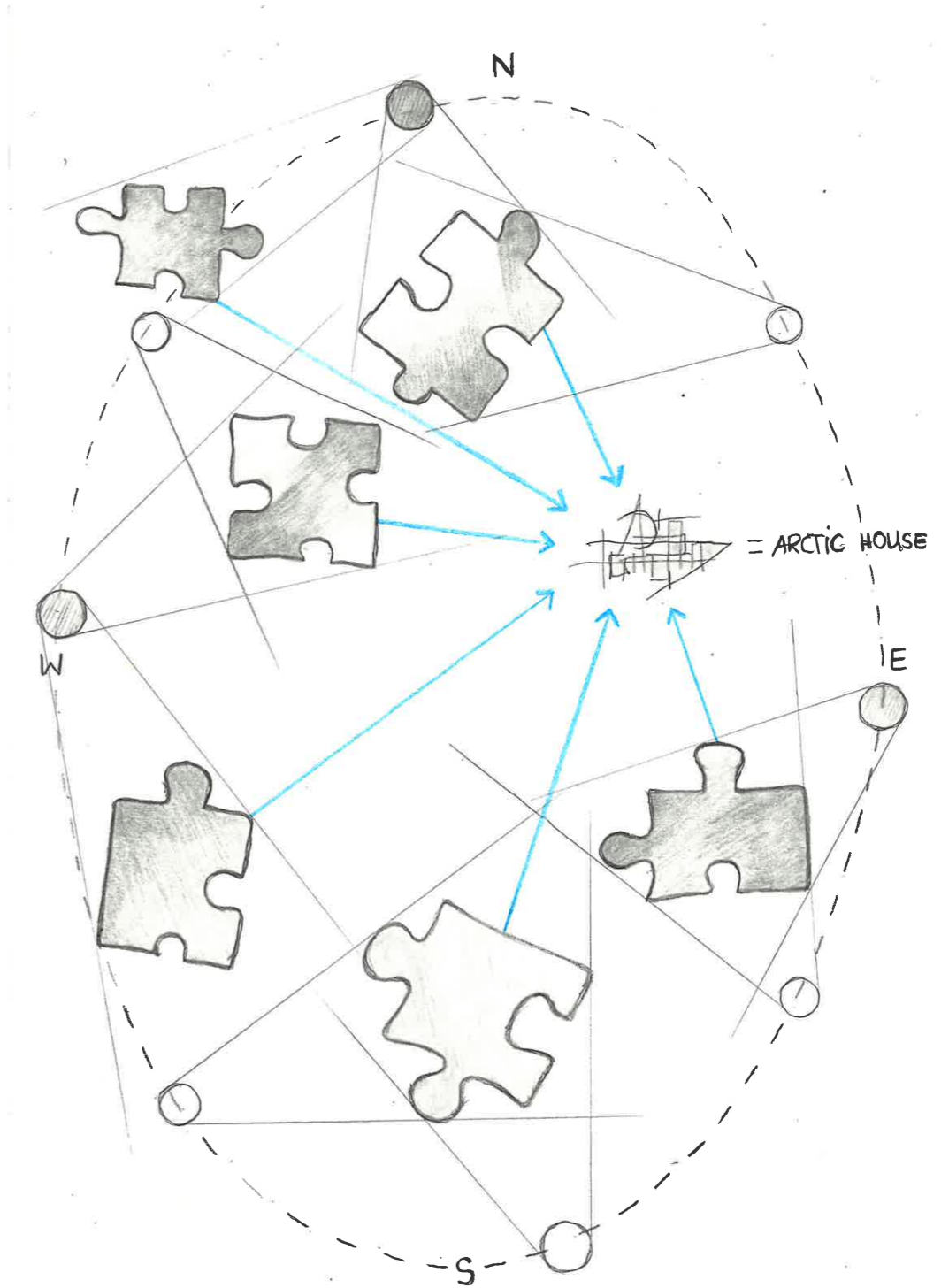

3.2 - Sun studies - Heliodon 1 - separate "puzzles" with different light qualities

ROOM/SPACE	1	- DARK (22:00 - 06:00) - LIGHT (06:00 - 22:00)
Regulations - program		
MARCH 15.03		
ANALYSIS - 70° N NOT AFFECTED BY THE CONTEXT		
00:00 am (HELIODON)	04:00 am (HELIODON)	08:00 am (HELIODON)
12:00 pm (HELIODON)	16:00 pm (HELIODON)	20:00 pm (HELIODON)

3.2 - Sun studies - Heliodon 1 - separate "puzzles" with different light qualities

ROOM/SPACE	1	- DARK (22:00 - 06:00) - LIGHT (06:00 - 22:00)
Regulations - program		
JUNE 15.06		
ANALYSIS - 70° N NOT AFFECTED BY THE CONTEXT		
00:00 am (HELIODON)	04:00 am (HELIODON)	08:00 am (HELIODON)
12:00 pm (HELIODON)	16:00 pm (HELIODON)	20:00 pm (HELIODON)

3.2 - Sun studies - Heliodon 1 - separate "puzzles" with different light qualities

ROOM/SPACE	1	- DARK (22:00 - 06:00) - LIGHT (06:00 - 22:00)
Regulations - program		
SEPTEMBER 15.09		
ANALYSIS - 70° N NOT AFFECTED BY THE CONTEXT		
00:00 am (HELIODON)	04:00 am (HELIODON)	08:00 am (HELIODON)
12:00 pm (HELIODON)	16:00 pm (HELIODON)	20:00 pm (HELIODON)

3.2 - Sun studies - Heliodon 1 - separate "puzzles" with different light qualities

ROOM/SPACE	1	- DARK (22:00 - 06:00) - LIGHT (06:00 - 22:00)
Regulations - program		
DECEMBER 15.12		
ANALYSIS - 70° N NOT AFFECTED BY THE CONTEXT		
00:00 am (HELIODON)	04:00 am (HELIODON)	08:00 am (HELIODON)
12:00 pm (HELIODON)	16:00 pm (HELIODON)	20:00 pm (HELIODON)



16:00 pm (HELIODON)
SEPTEMBER 15.09

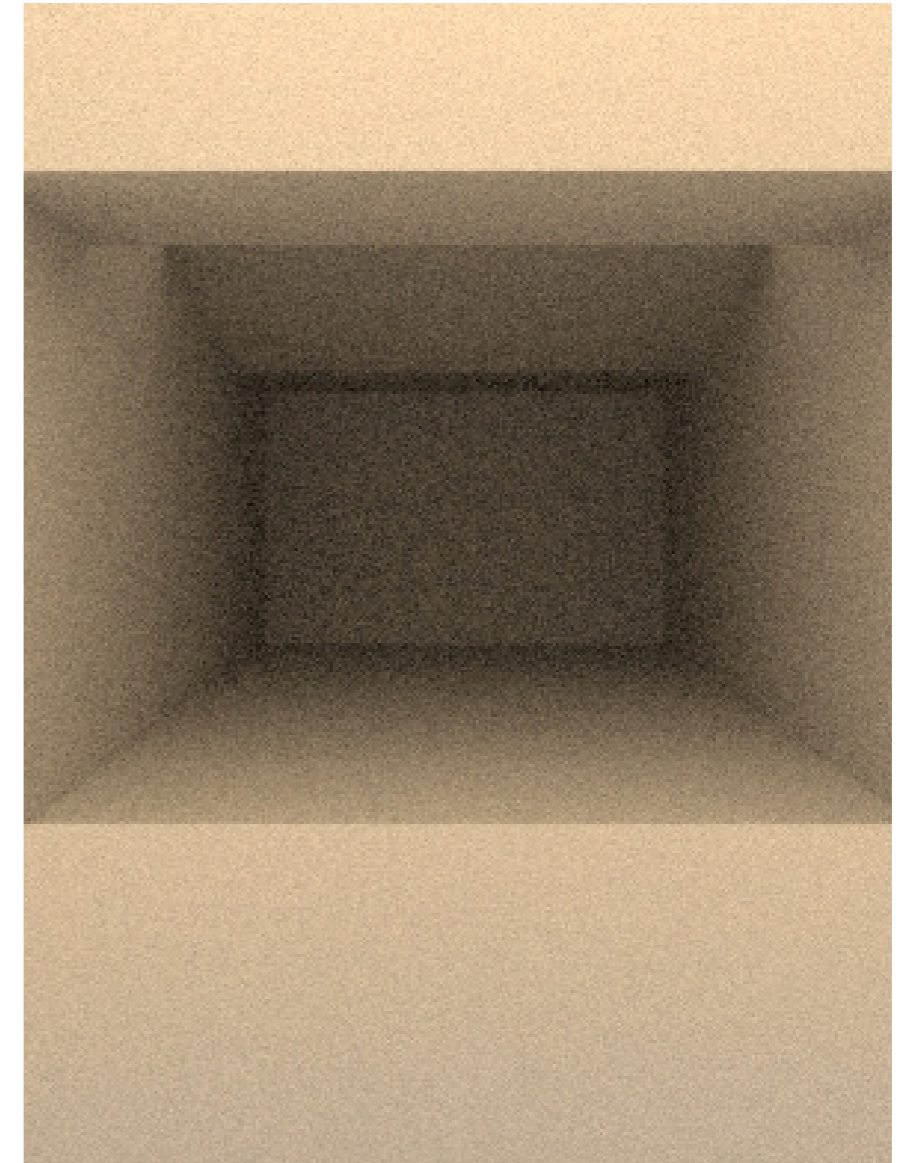

16:00 pm (DIGITAL SUN ANALYSIS)
SEPTEMBER 15.09

3.2 - Sun studies - Heliodon 1 - separate "puzzles" with different light qualities

ROOM/SPACE	2	- DIFFUSE LIGHT AT ALL TIME	
Regulations - program			
MARCH 15.03			
ANALYSIS - 70° N NOT AFFECTED BY THE CONTEXT			
	00:00 am (HELIODON)	04:00 am (HELIODON)	08:00 am (HELIODON)
	12:00 pm (HELIODON)	16:00 pm (HELIODON)	20:00 pm (HELIODON)

3.2 - Sun studies - Heliodon 1 - separate "puzzles" with different light qualities

ROOM/SPACE	2	- DIFFUSE LIGHT AT ALL TIME	
Regulations - program			
JUNE 15.06			
ANALYSIS - 70° N NOT AFFECTED BY THE CONTEXT			
	00:00 am (HELIODON)	04:00 am (HELIODON)	08:00 am (HELIODON)
	12:00 pm (HELIODON)	16:00 pm (HELIODON)	20:00 pm (HELIODON)



20:00 pm (HELIODON)
JUNE 15.06

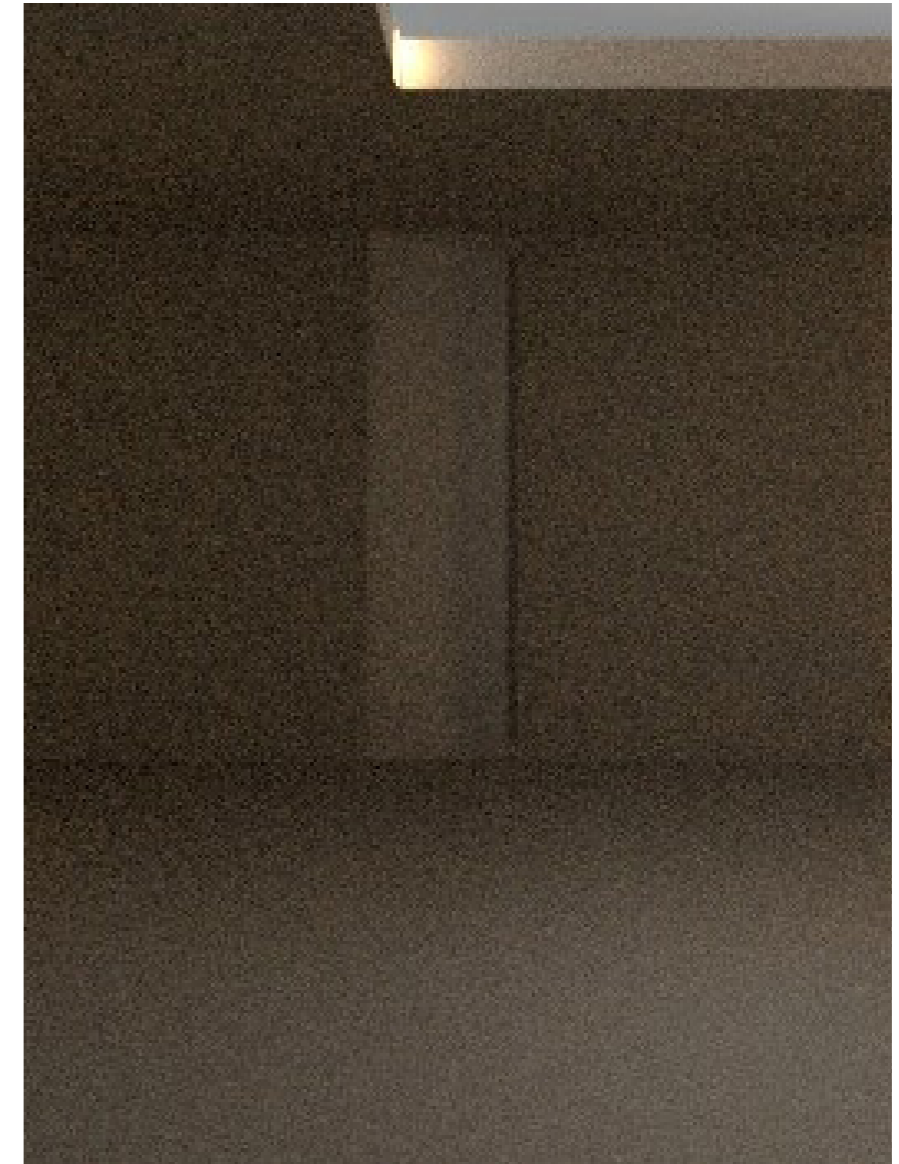

20:00 pm (DIGITAL SUN ANALYSIS)
JUNE 15.06

3.2 - Sun studies - Heliodon 1 - separate "puzzles" with different light qualities

ROOM/SPACE	3	- DIRECT AND INDIRECT LIGHT AT ALL TIME	
Regulations - program			
MARCH 15.03			
ANALYSIS - 70° N NOT AFFECTED BY THE CONTEXT			
	00:00 am (HELIODON)	04:00 am (HELIODON)	08:00 am (HELIODON)
	12:00 pm (HELIODON)	16:00 pm (HELIODON)	20:00 pm (HELIODON)

3.2 - Sun studies - Heliodon 1 - separate "puzzles" with different light qualities

ROOM/SPACE	3	- DIRECT AND INDIRECT LIGHT AT ALL TIME	
Regulations - program			
JUNE 15.06			
ANALYSIS - 70° N NOT AFFECTED BY THE CONTEXT			
	00:00 am (HELIODON)	04:00 am (HELIODON)	08:00 am (HELIODON)
	12:00 pm (HELIODON)	16:00 pm (HELIODON)	20:00 pm (HELIODON)

3.2 - Sun studies - Heliodon 1 - separate "puzzles" with different light qualities

ROOM/SPACE	3	- DIRECT AND INDIRECT LIGHT AT ALL TIME	
Regulations - program			
SEPTEMBER 15.09			
ANALYSIS - 70° N NOT AFFECTED BY THE CONTEXT			
00:00 am (HELIODON)	04:00 am (HELIODON)	08:00 am (HELIODON)	
12:00 pm (HELIODON)	16:00 pm (HELIODON)	20:00 pm (HELIODON)	

3.2 - Sun studies - Heliodon 1 - separate "puzzles" with different light qualities

ROOM/SPACE	3	- DIRECT AND INDIRECT LIGHT AT ALL TIME	
Regulations - program			
DECEMBER 15.12			
ANALYSIS - 70° N NOT AFFECTED BY THE CONTEXT			
00:00 am (HELIODON)	04:00 am (HELIODON)	08:00 am (HELIODON)	
12:00 pm (HELIODON)	16:00 pm (HELIODON)	20:00 pm (HELIODON)	



00:00 am (HELIODON)
JUNE 15.06

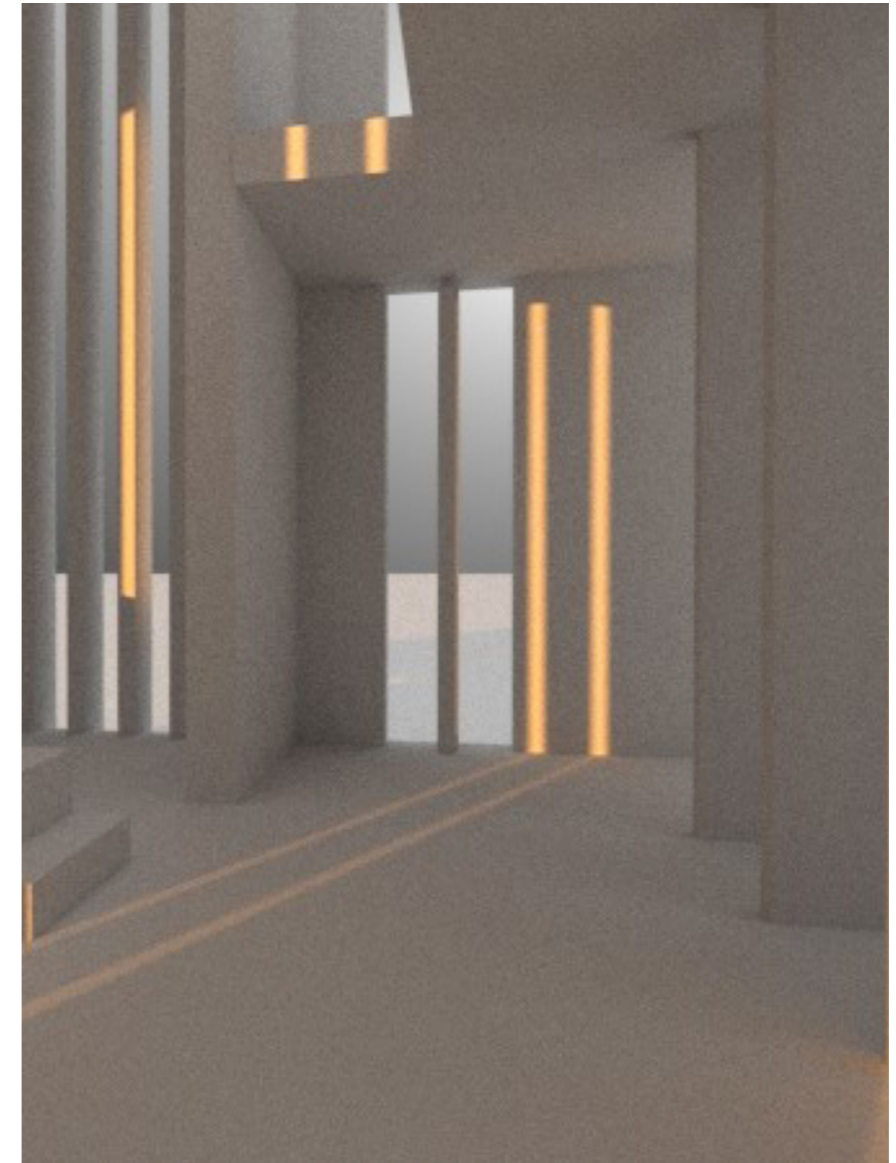

00:00 am (DIGITAL SUN ANALYSIS)
JUNE 15.06



3.2 - Sun studies - Heliodon 1 - seperate "puzzles" with different light qualities

ROOM/SPACE	4	NO DIRECT SUNLIGHT		
Regulations - program				
MARCH 15.03				
ANALYSIS - 70° N NOT AFFECTED BY THE CONTEXT				
	00:00 am (HELIODON)	04:00 am (HELIODON)	08:00 am (HELIODON)	
	12:00 pm (HELIODON)	16:00 pm (HELIODON)	20:00 pm (HELIODON)	



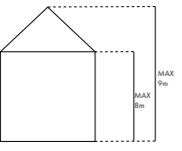
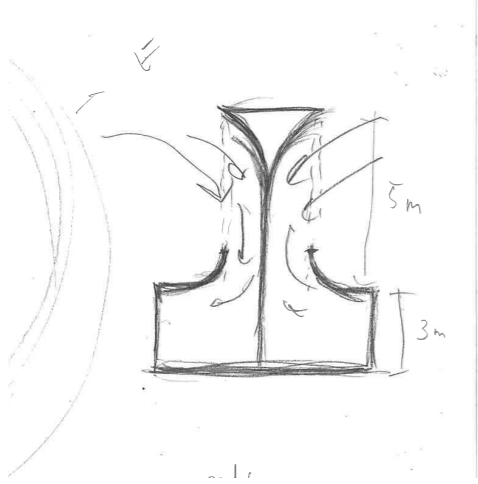

3.2 - Sun studies - Heliodon 1 - seperate "puzzles" with different light qualities

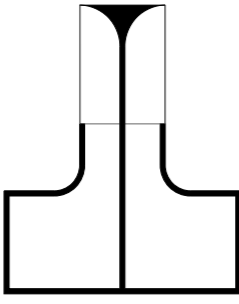
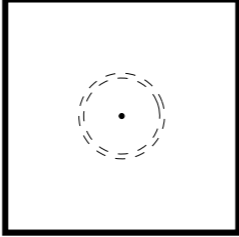
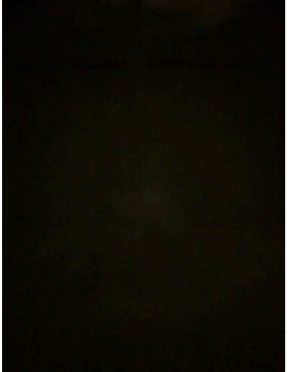
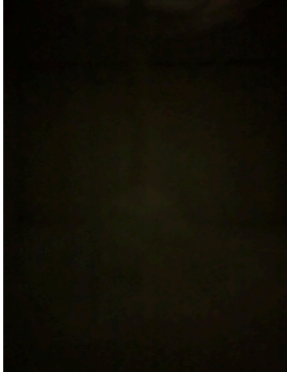
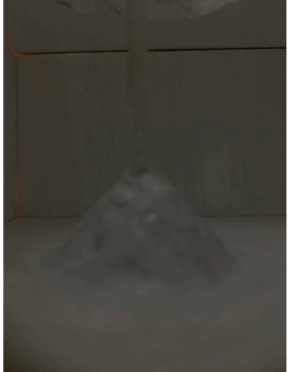
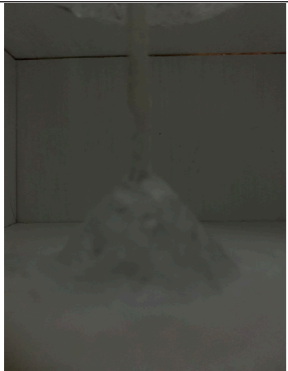
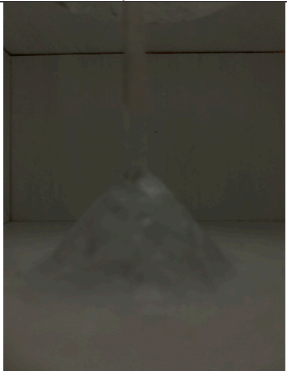
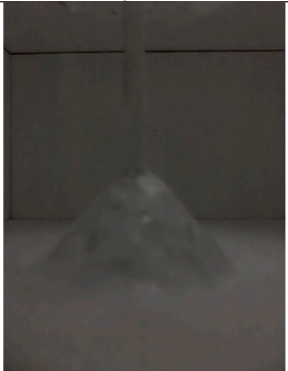
ROOM/SPACE	4	NO DIRECT SUNLIGHT		
Regulations - program				
JUNE 15.06				
ANALYSIS - 70° N NOT AFFECTED BY THE CONTEXT				
	00:00 am (HELIODON)	04:00 am (HELIODON)	08:00 am (HELIODON)	
	12:00 pm (HELIODON)	16:00 pm (HELIODON)	20:00 pm (HELIODON)	

3.2 - Sun studies - Heliodon 1 - separate "puzzles" with different light qualities

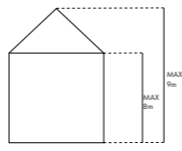
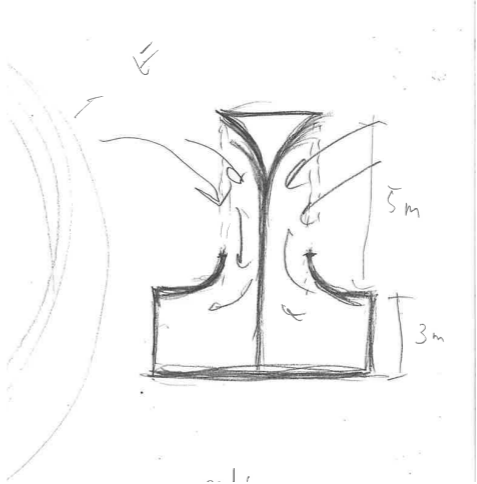
ROOM/SPACE	4	NO DIRECT SUNLIGHT	
Regulations - program			
SEPTEMBER 15.09			
ANALYSIS - 70° N NOT AFFECTED BY THE CONTEXT			
			
			
00:00 am (HELIODON)	04:00 am (HELIODON)	08:00 am (HELIODON)	
			
12:00 pm (HELIODON)	16:00 pm (HELIODON)	20:00 pm (HELIODON)	

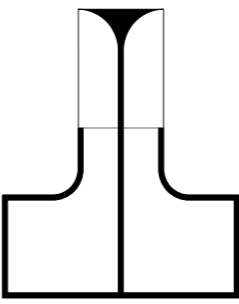
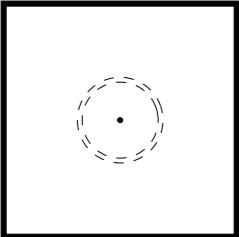
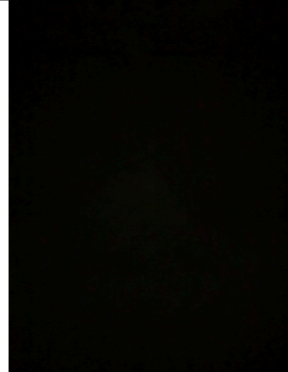
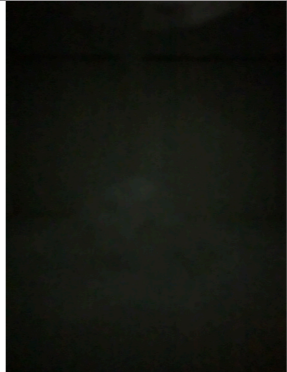
3.2 - Sun studies - Heliodon 1 - separate "puzzles" with different light qualities

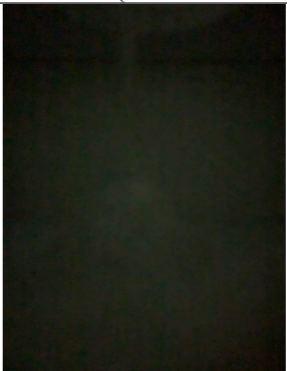
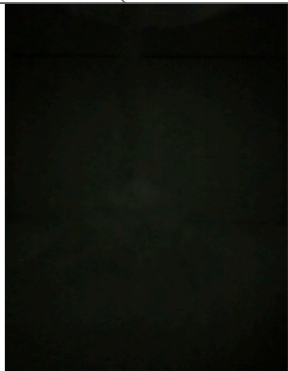
ROOM/SPACE	4	NO DIRECT SUNLIGHT	
Regulations - program			
DECEMBER 15.12			
ANALYSIS - 70° N NOT AFFECTED BY THE CONTEXT			
			
			
00:00 am (HELIODON)	04:00 am (HELIODON)	08:00 am (HELIODON)	
			
12:00 pm (HELIODON)	16:00 pm (HELIODON)	20:00 pm (HELIODON)	



16:00 pm (HELIODON)
JUNE 15.06

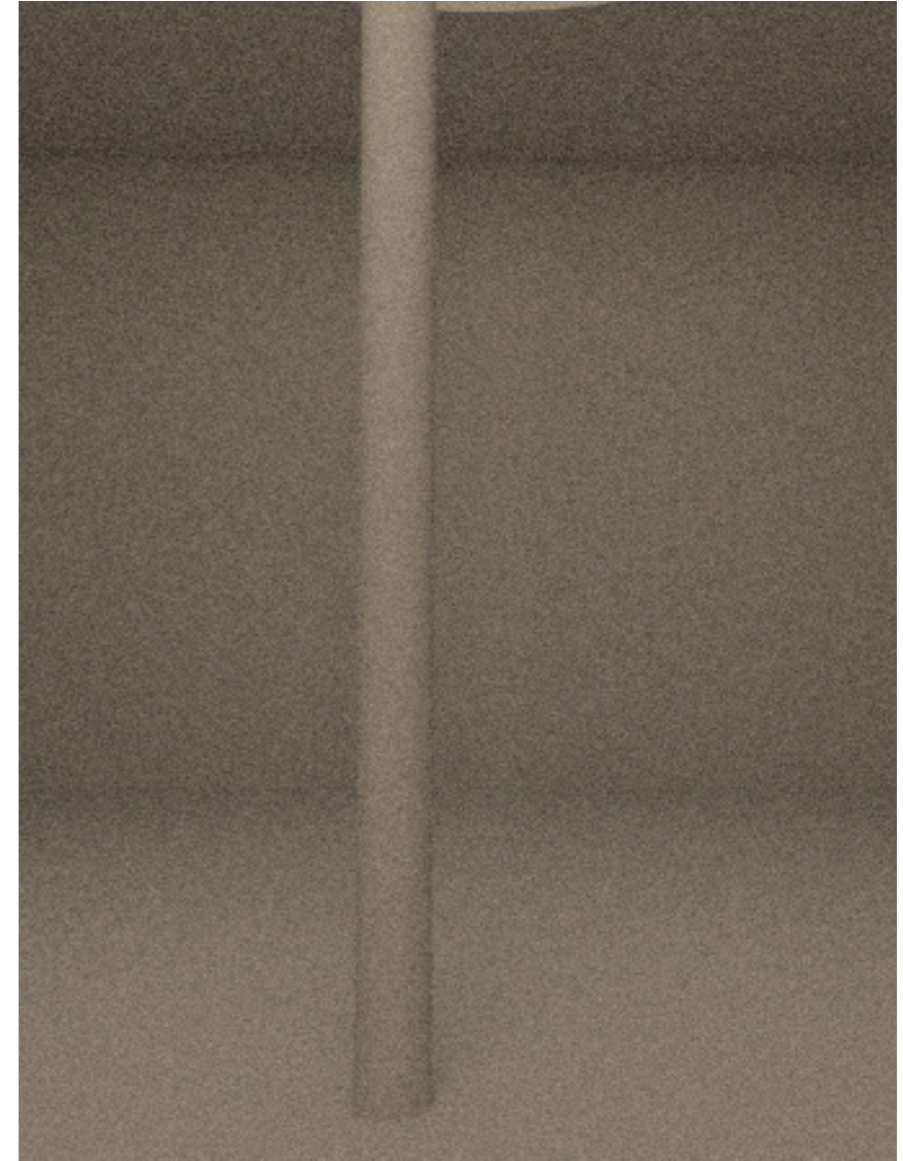

16:00 pm (DIGITAL SUN ANALYSIS)
JUNE 15.06

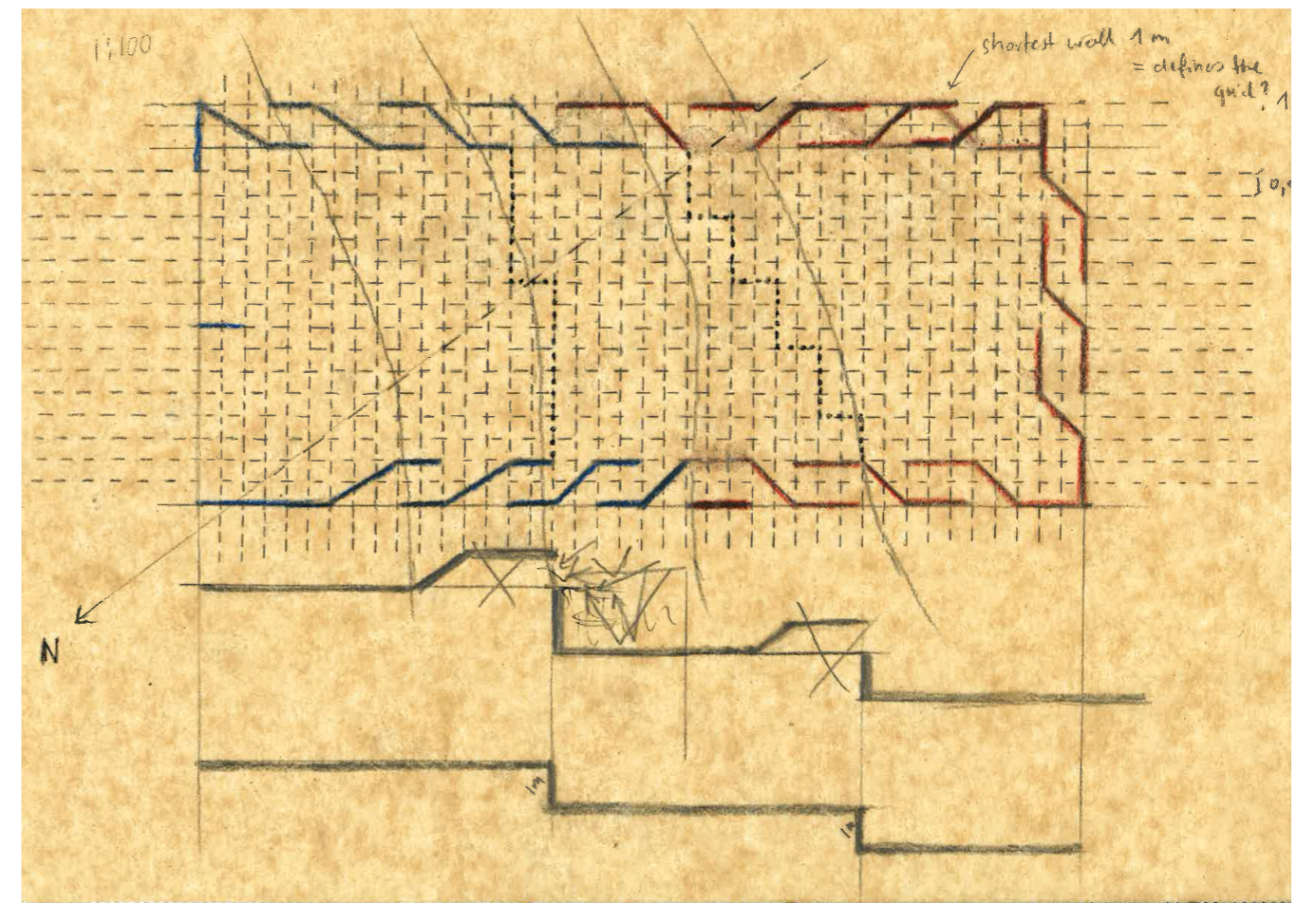
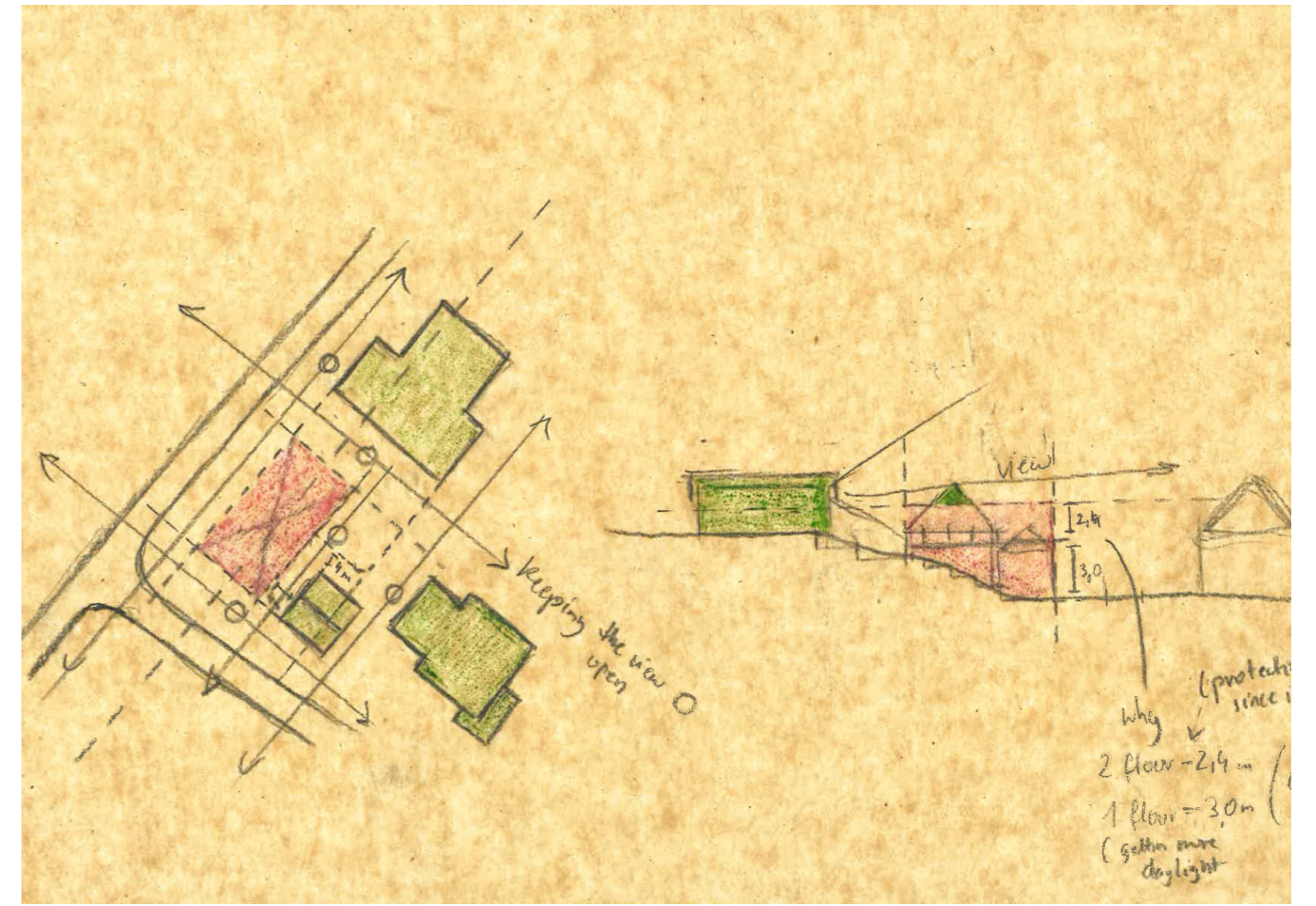
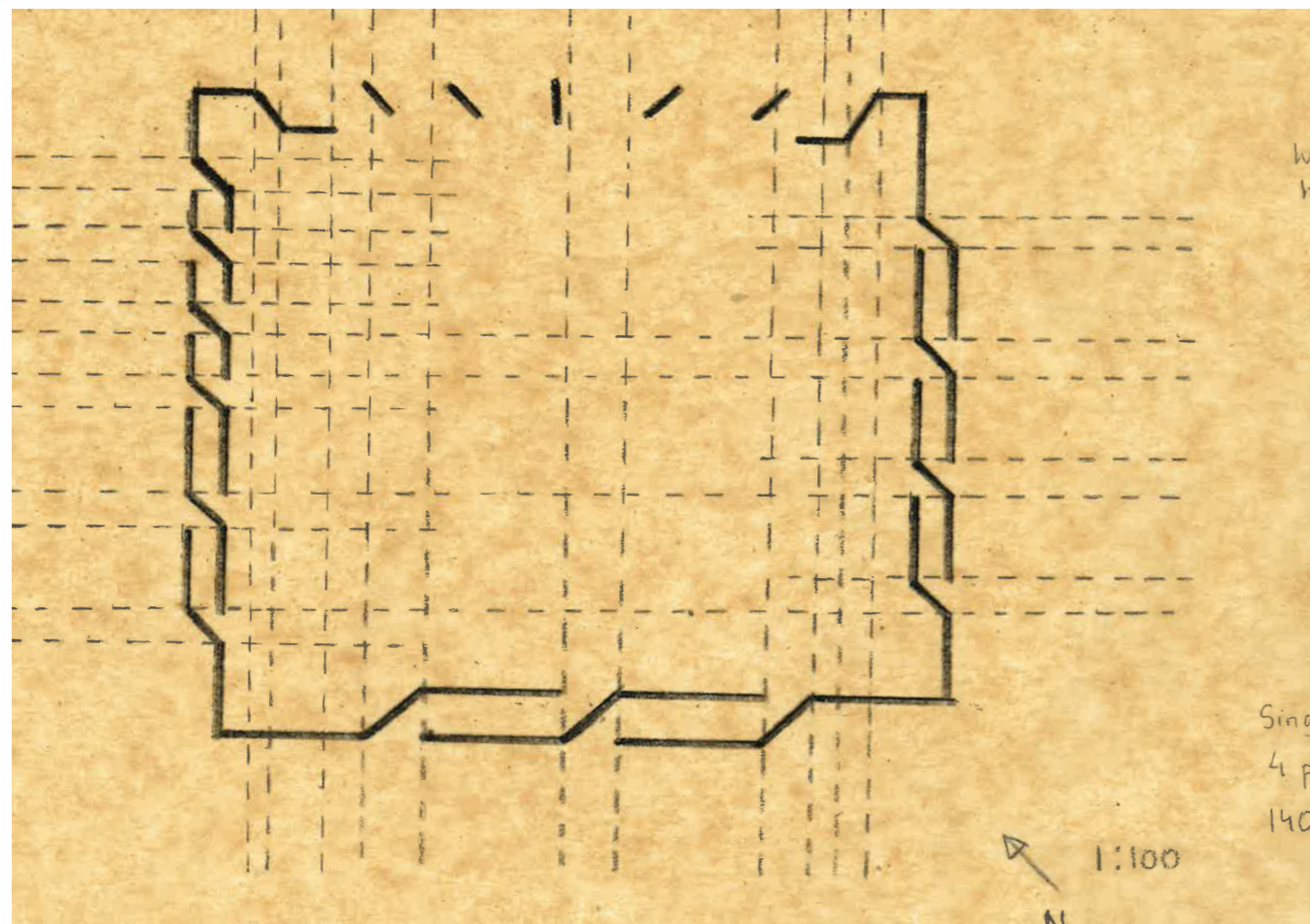
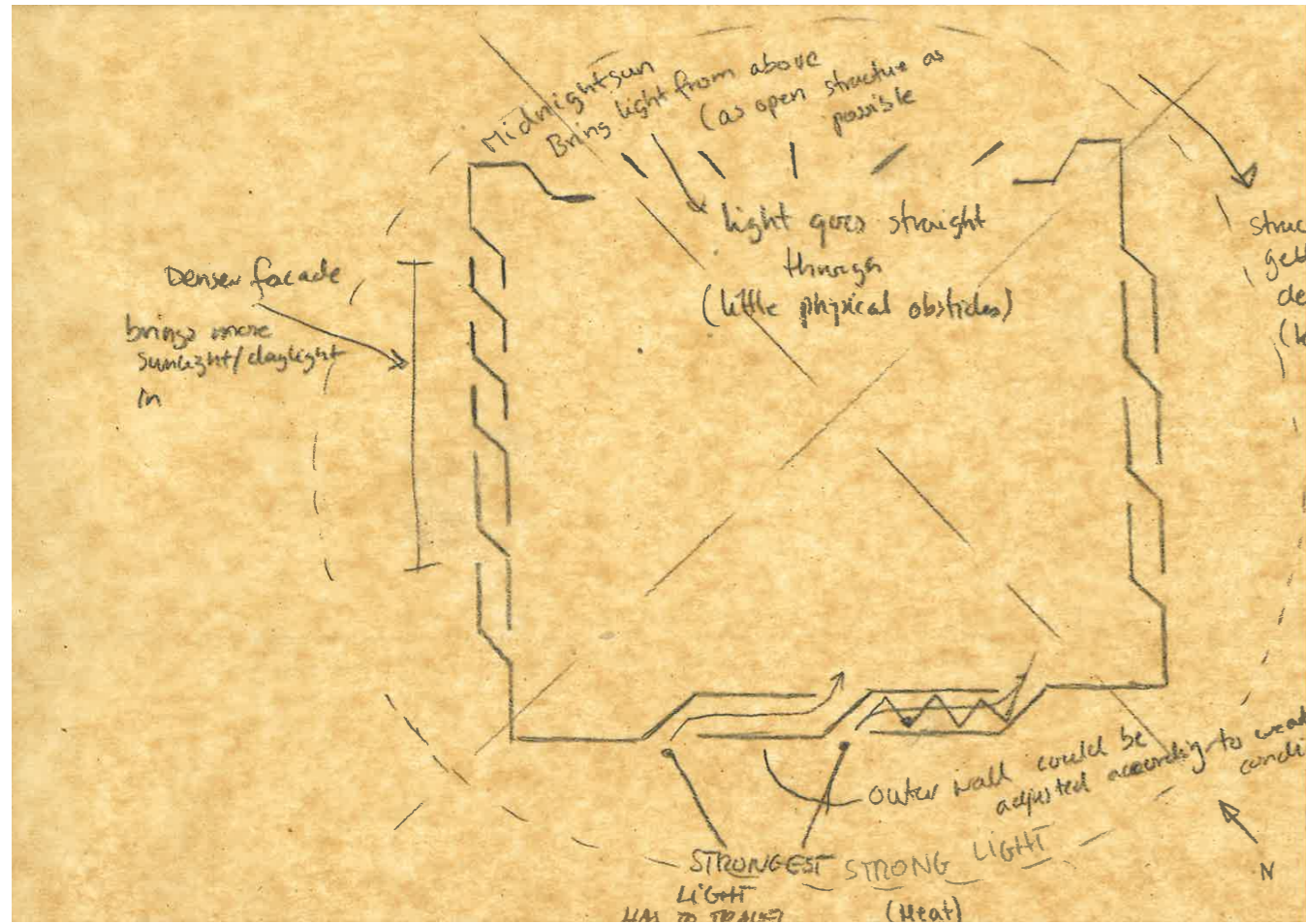

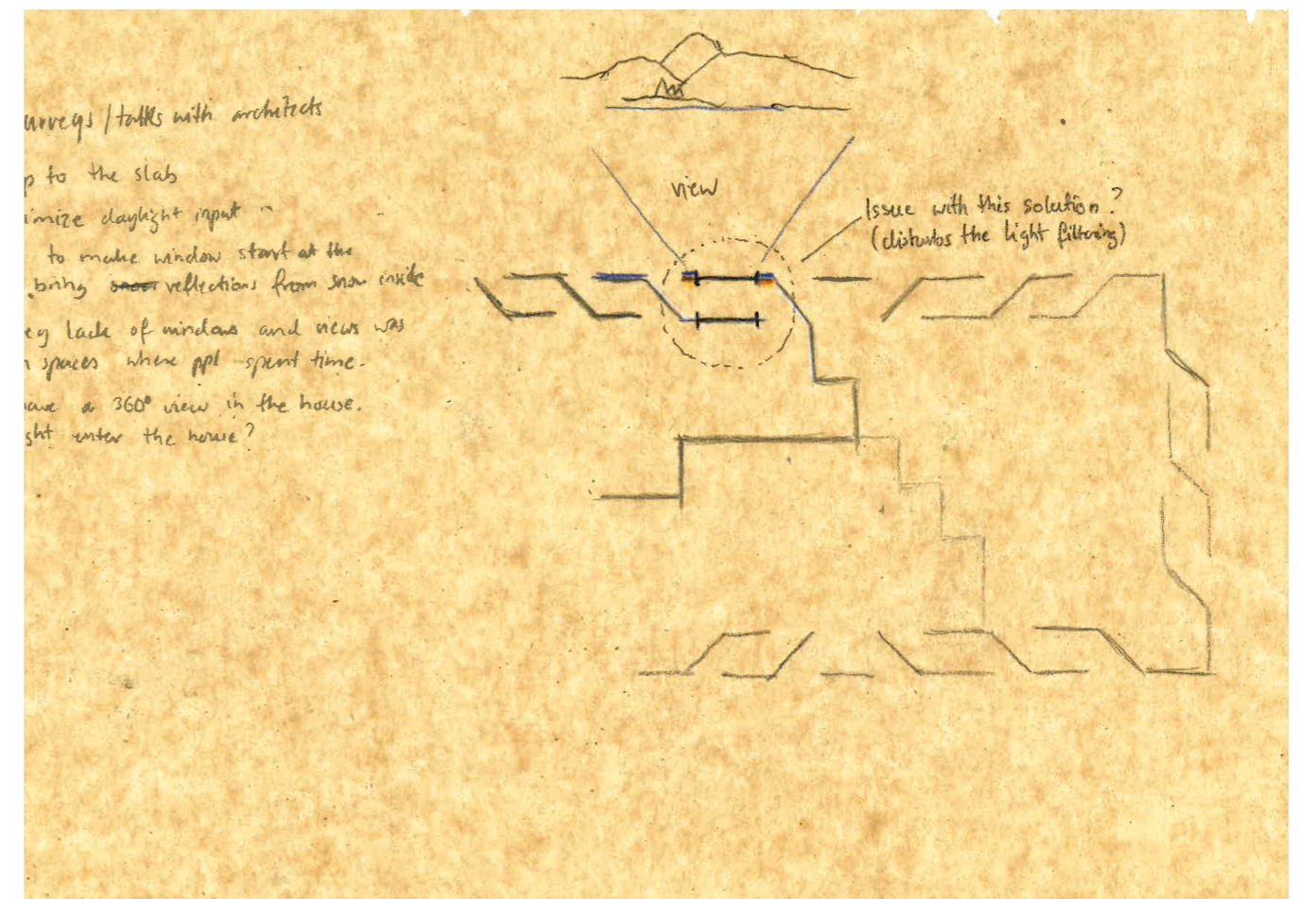
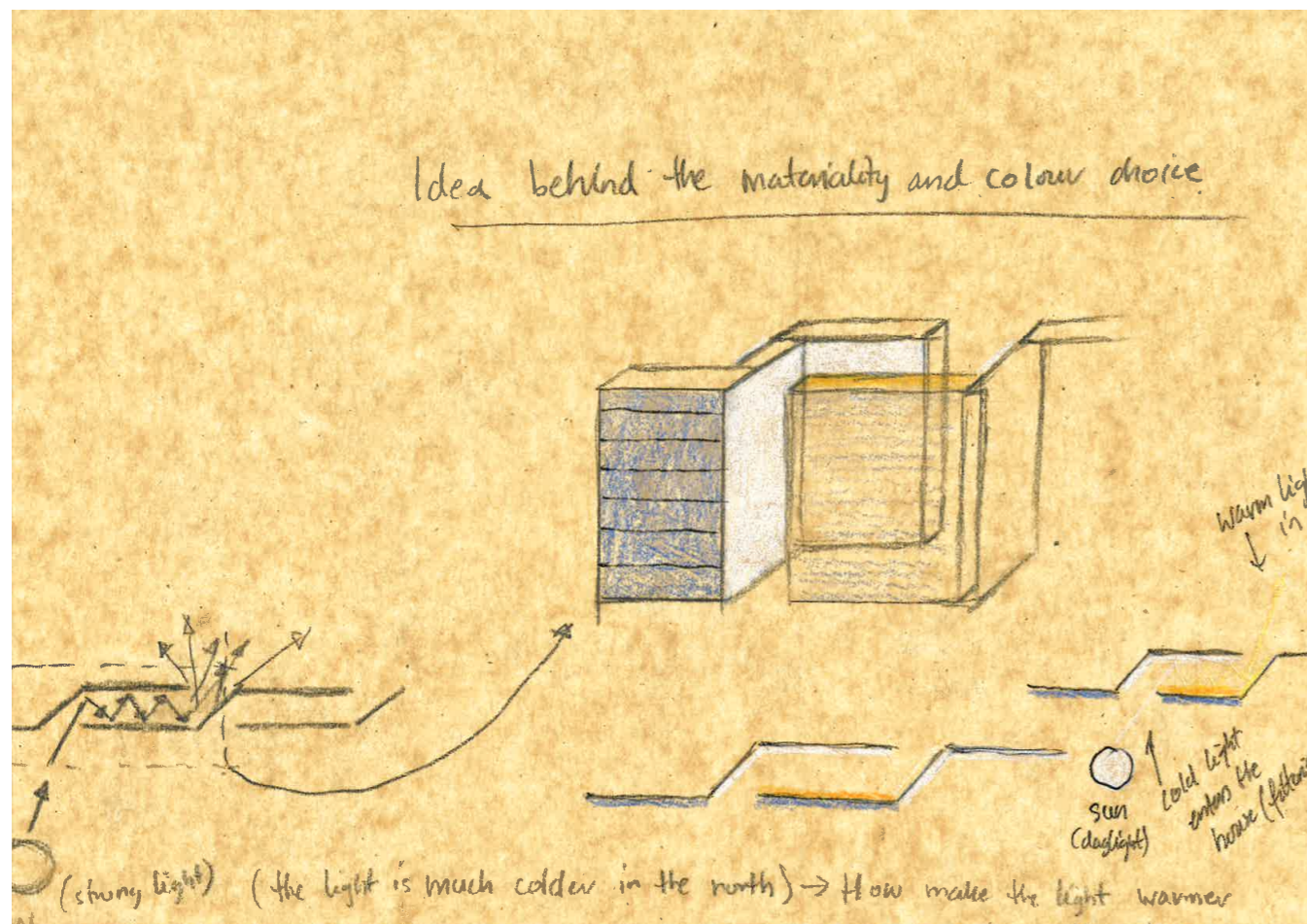
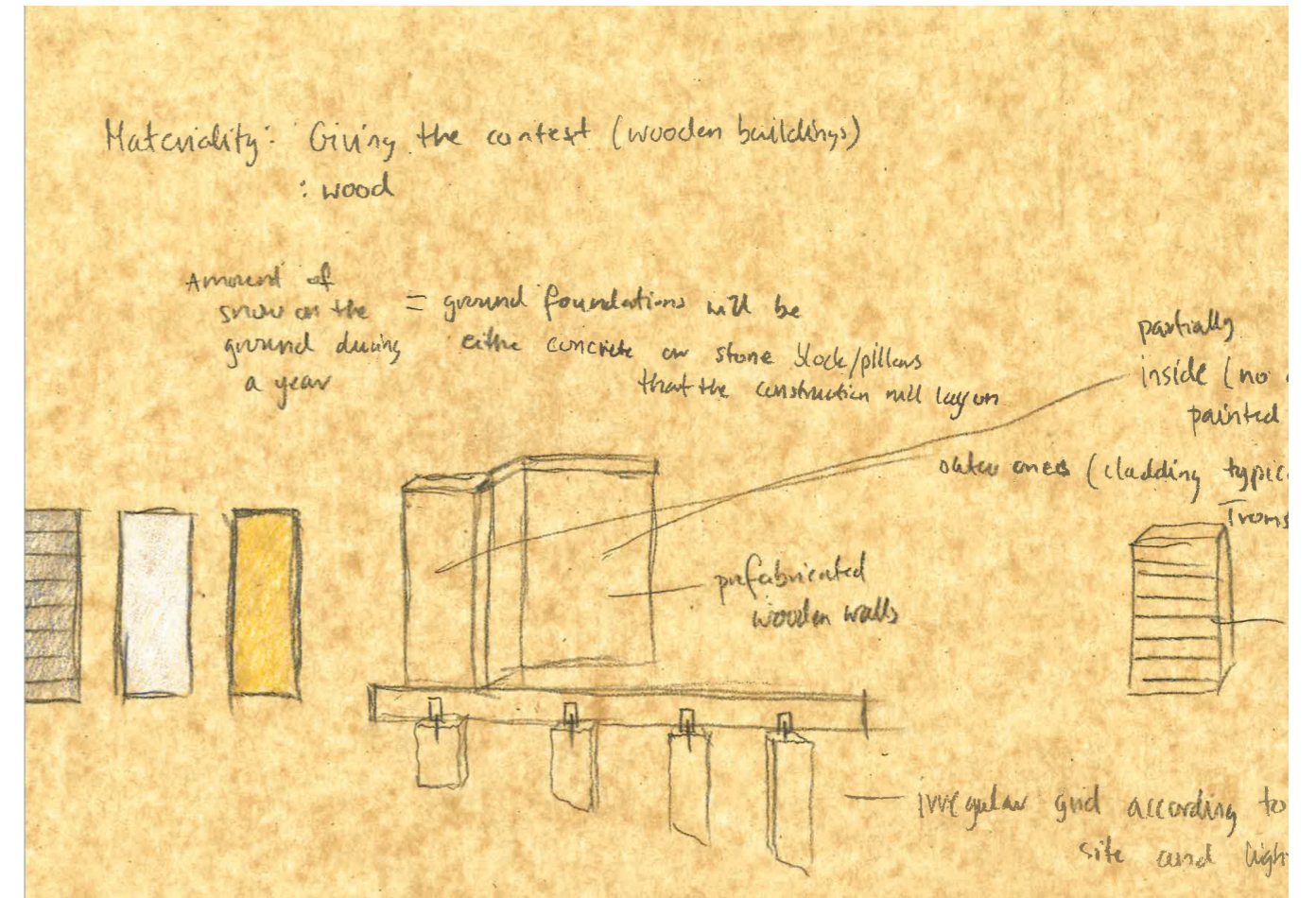
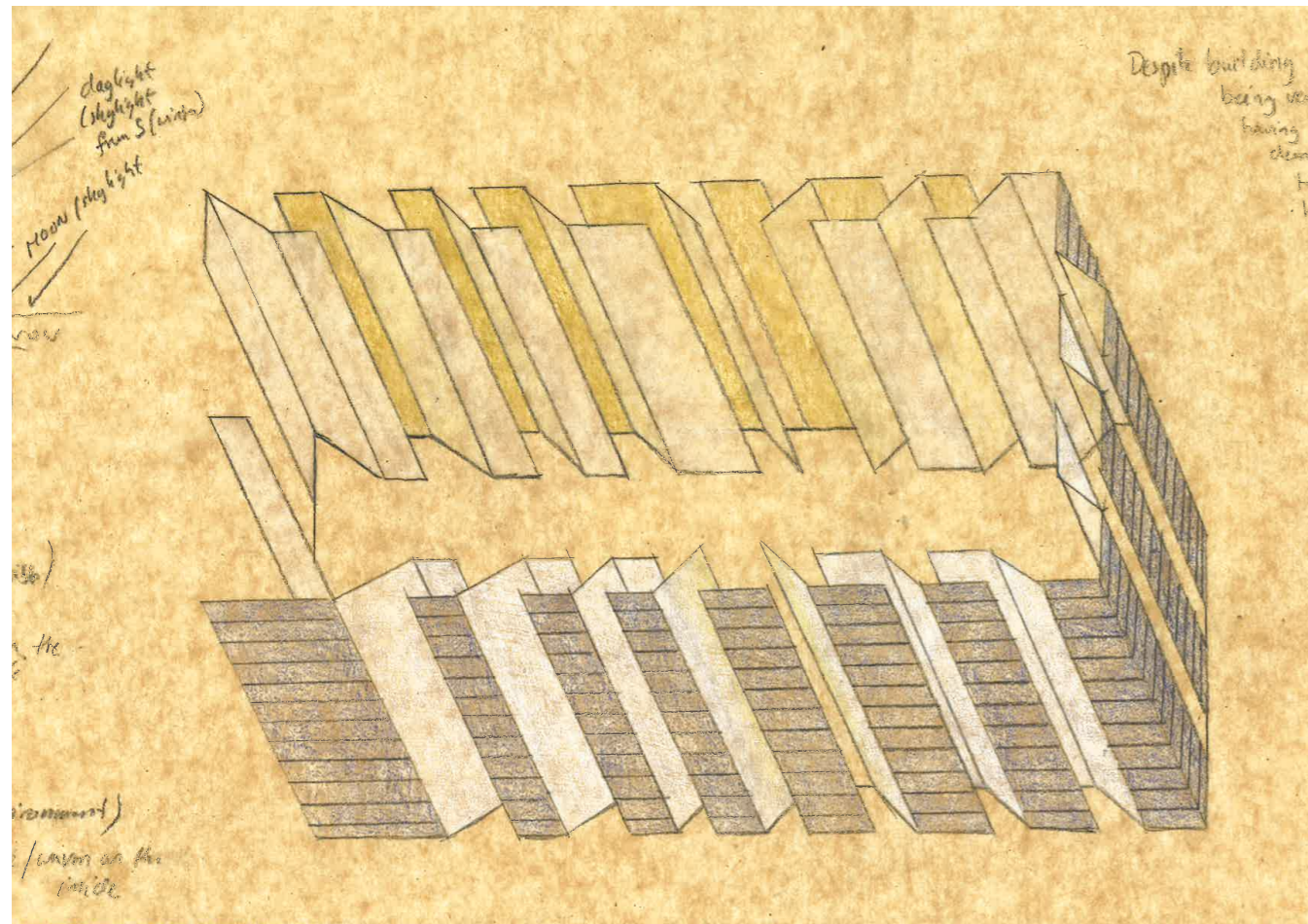

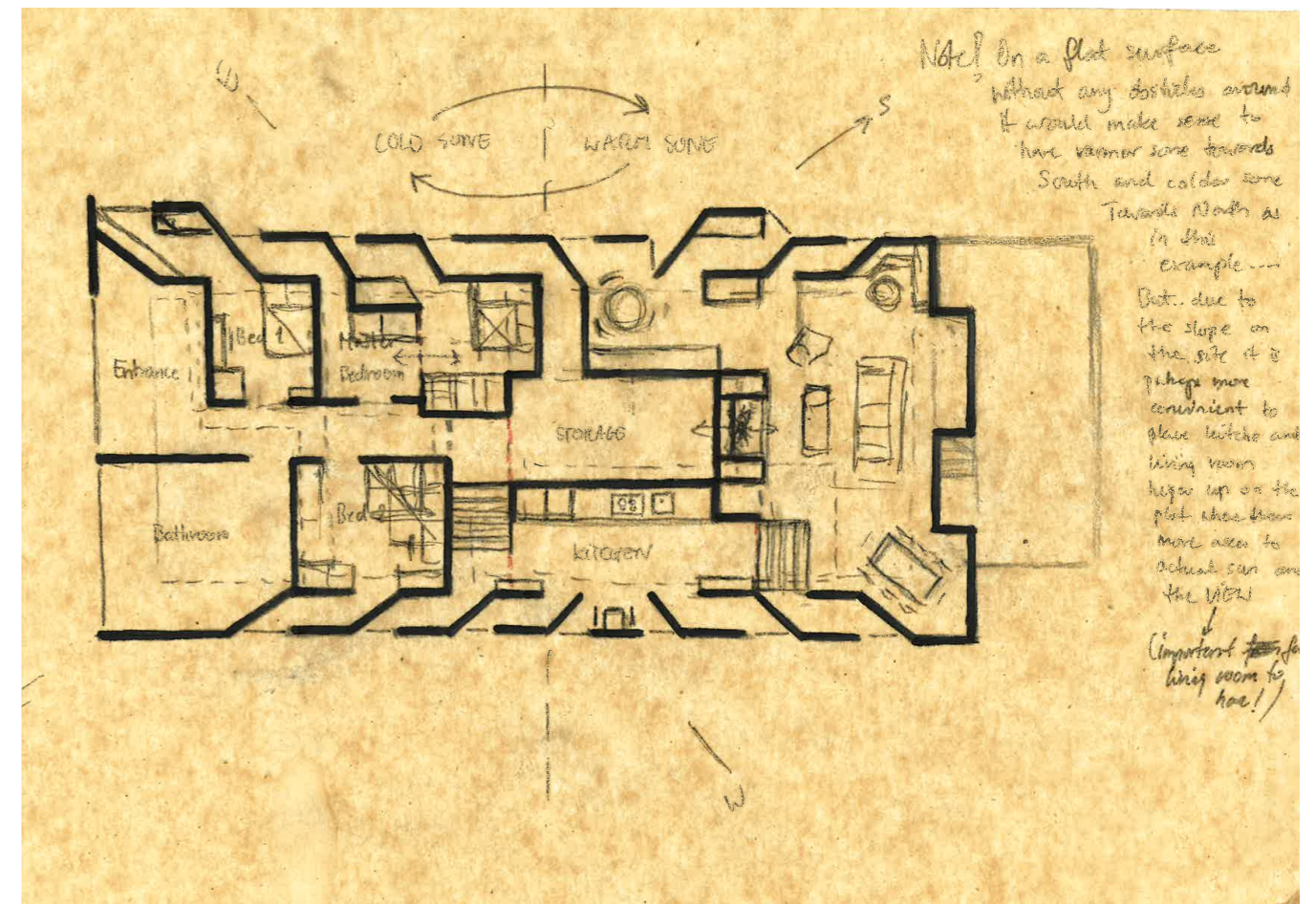
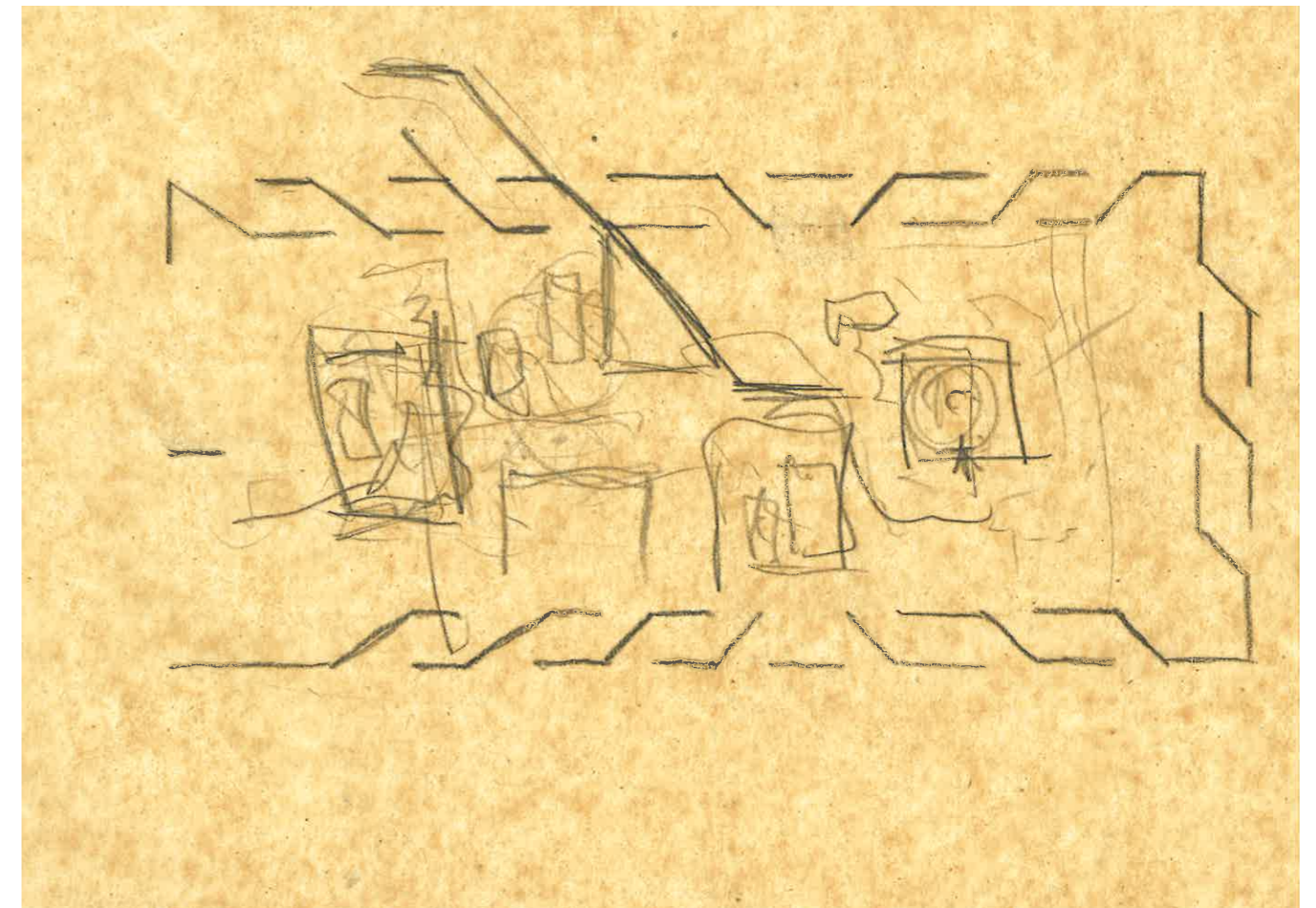
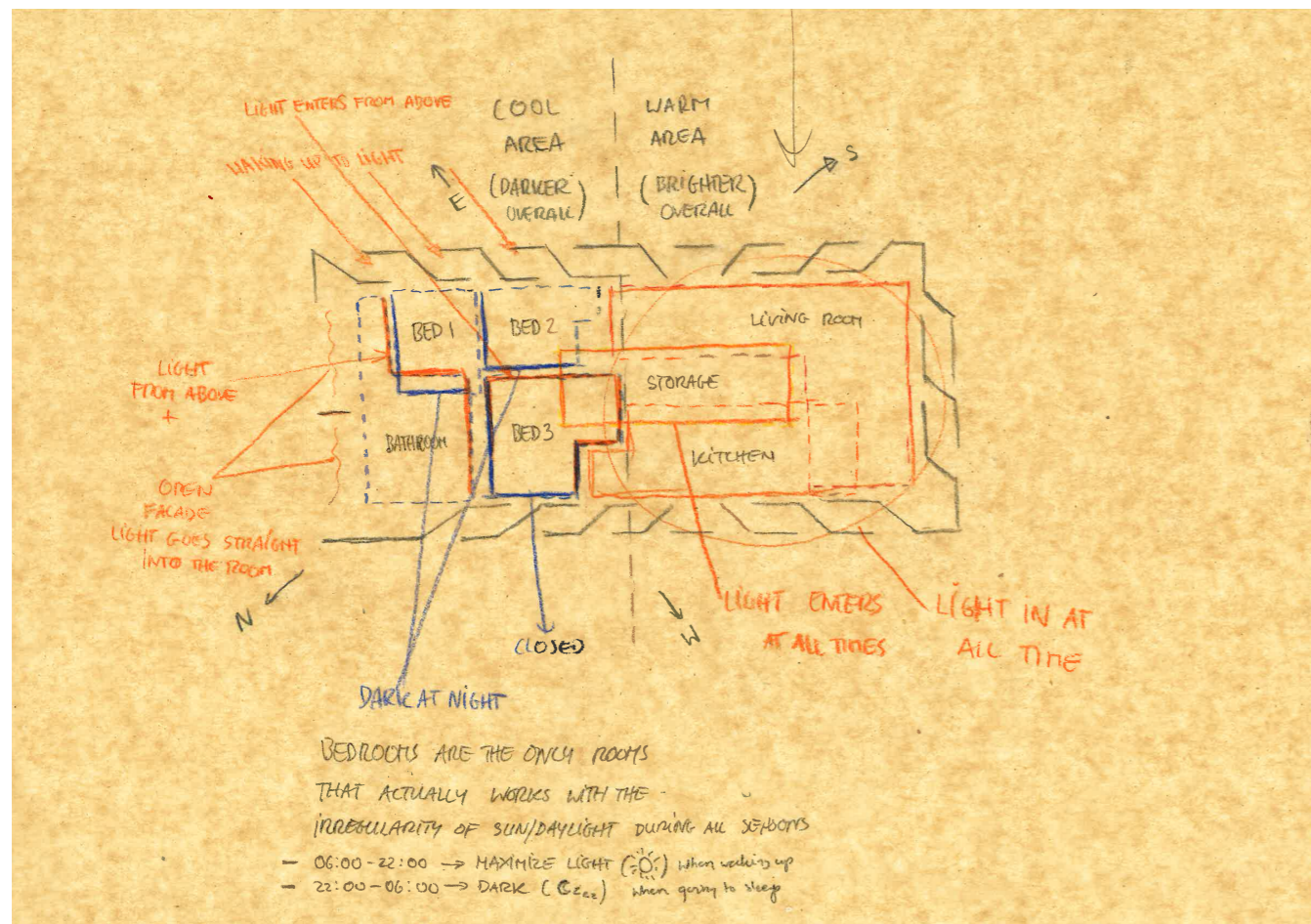
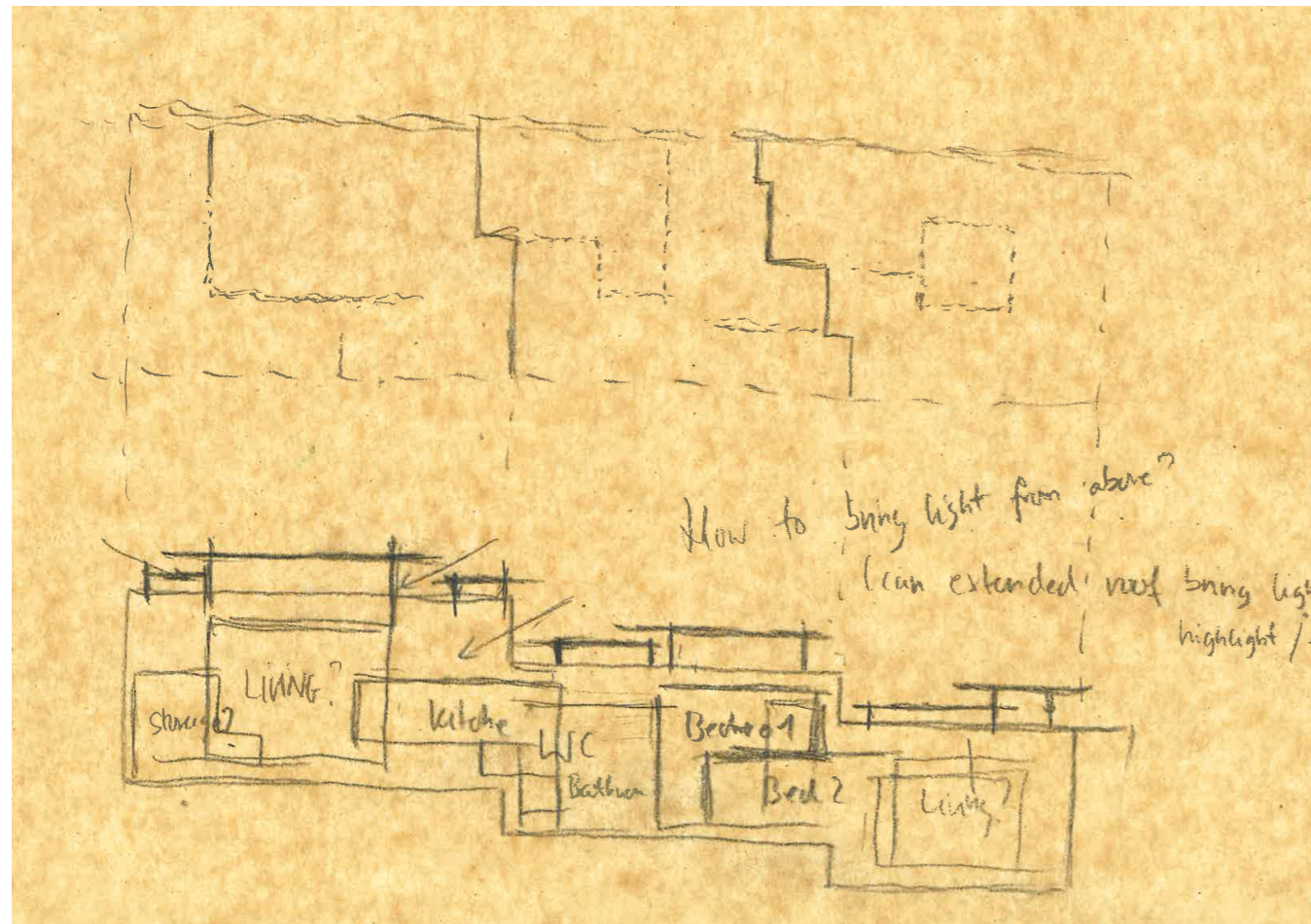

3.3 - Sketches - process

In addition to create calmer and warmer atmosphere on the inside I tried to test what materials could filter outdoor (cold) light.

METAL

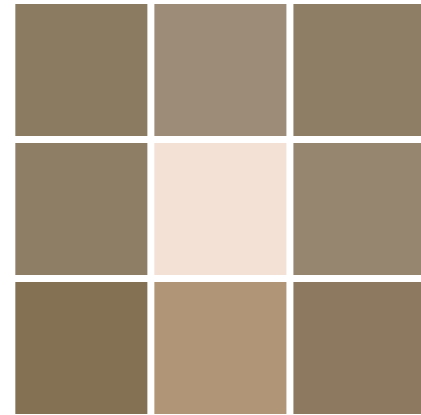
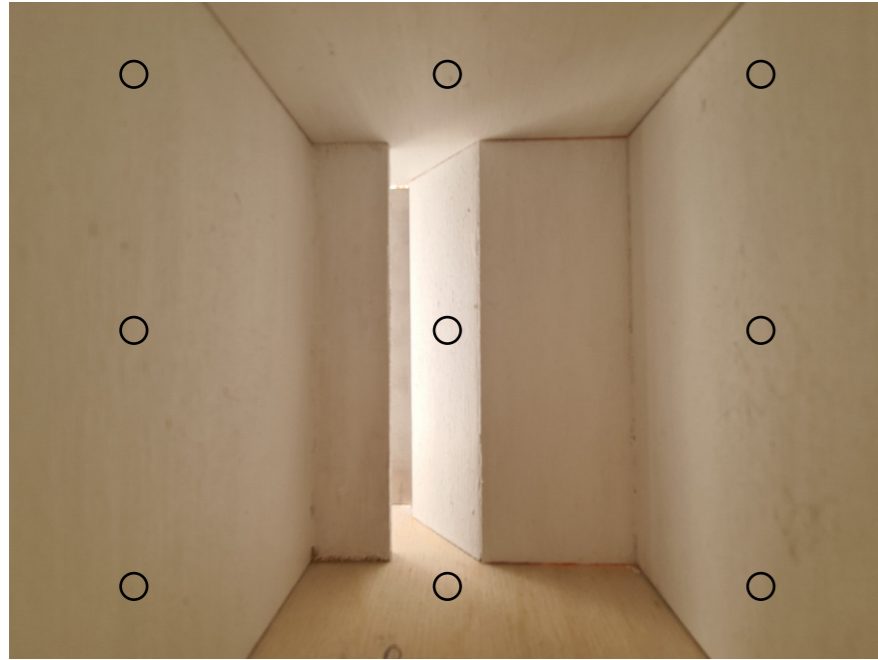

3.3 - Sketches - process

WOOD - PAINTED WHITE

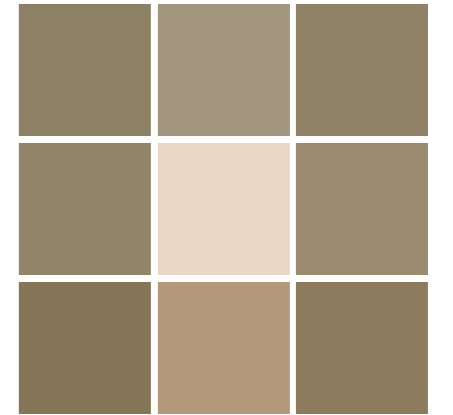
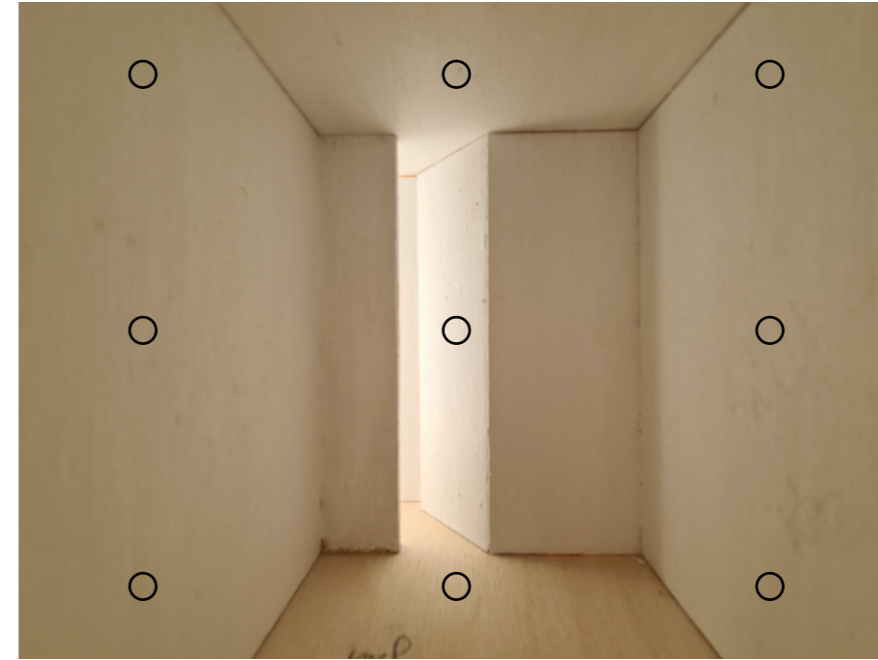

WHITE CONCRETE

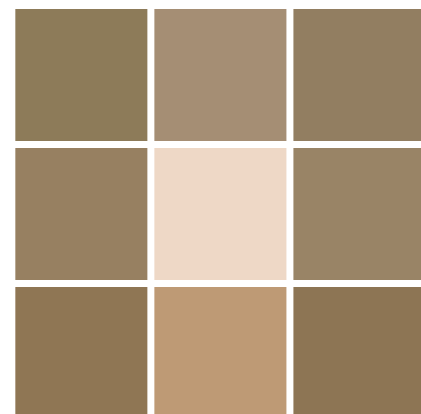
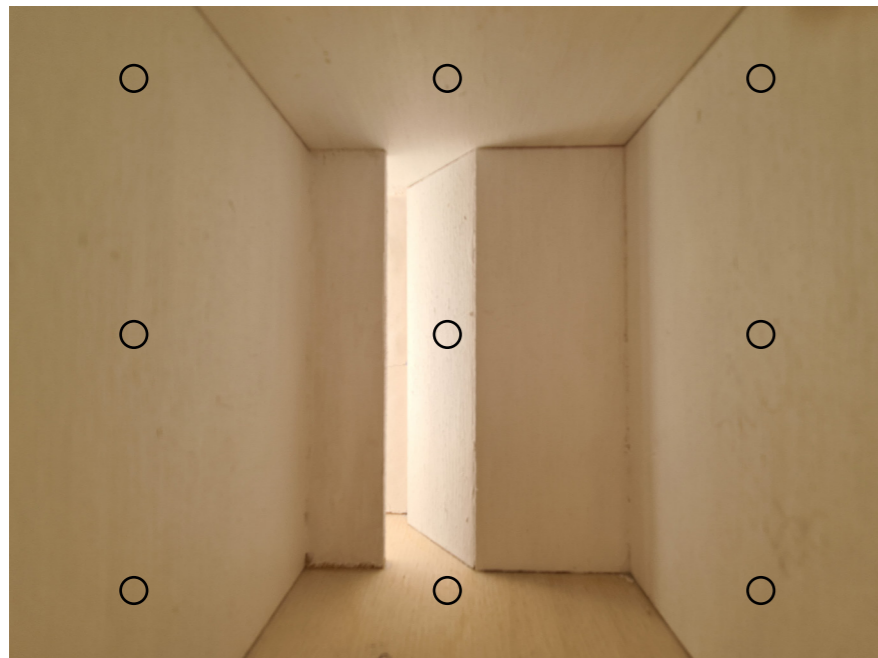

WOOD

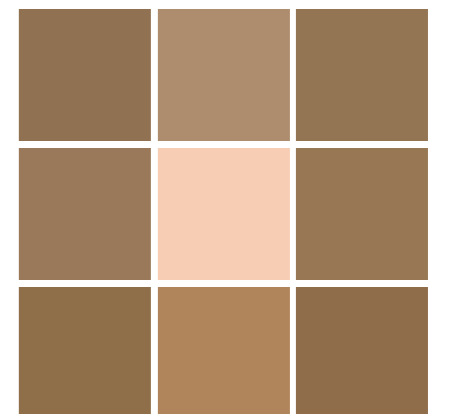
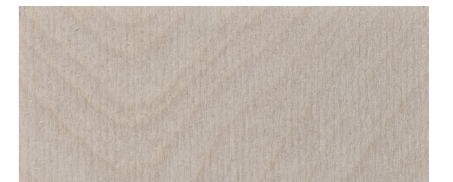
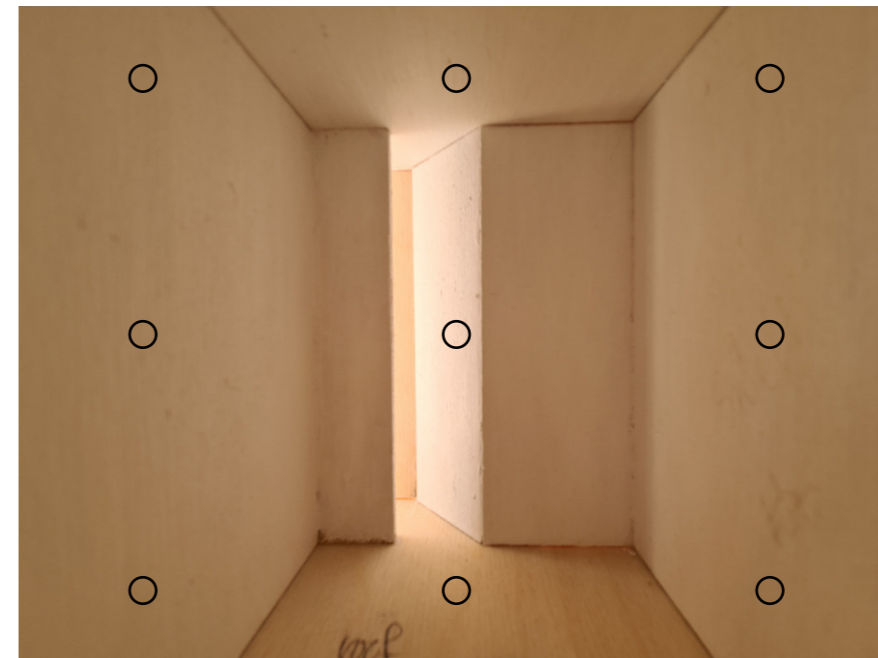

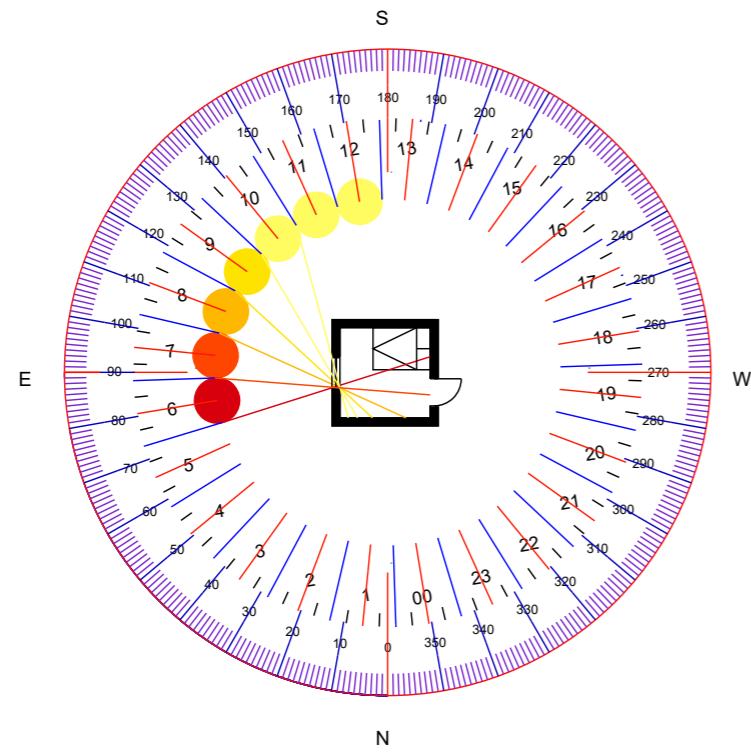

15. September - Tromsø

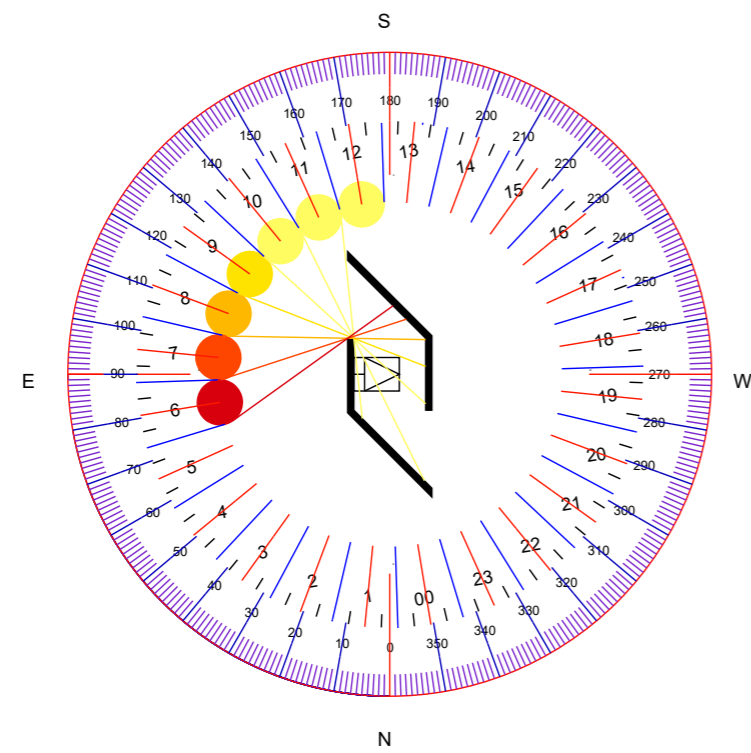

15. September - Tromsø

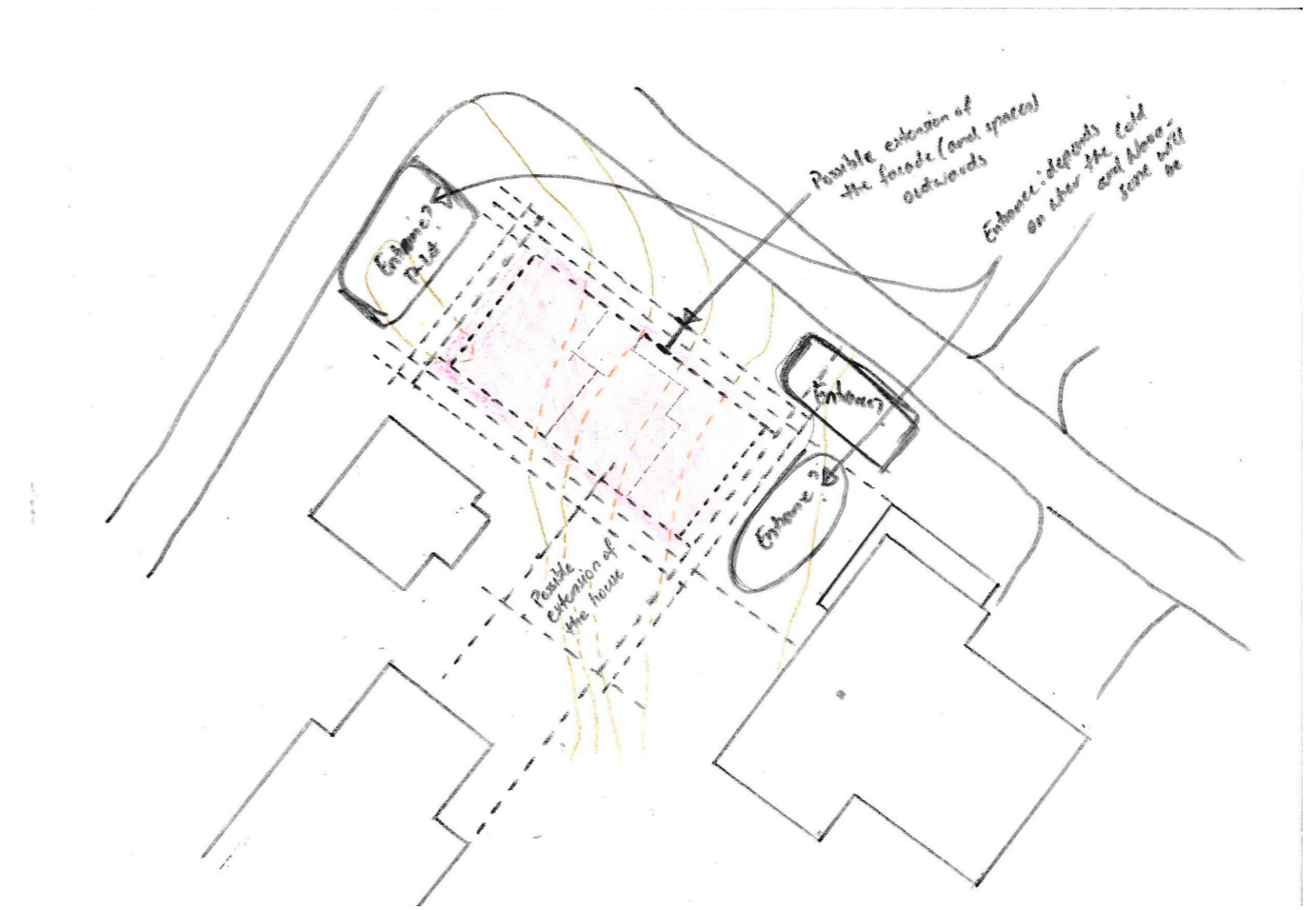

Site office

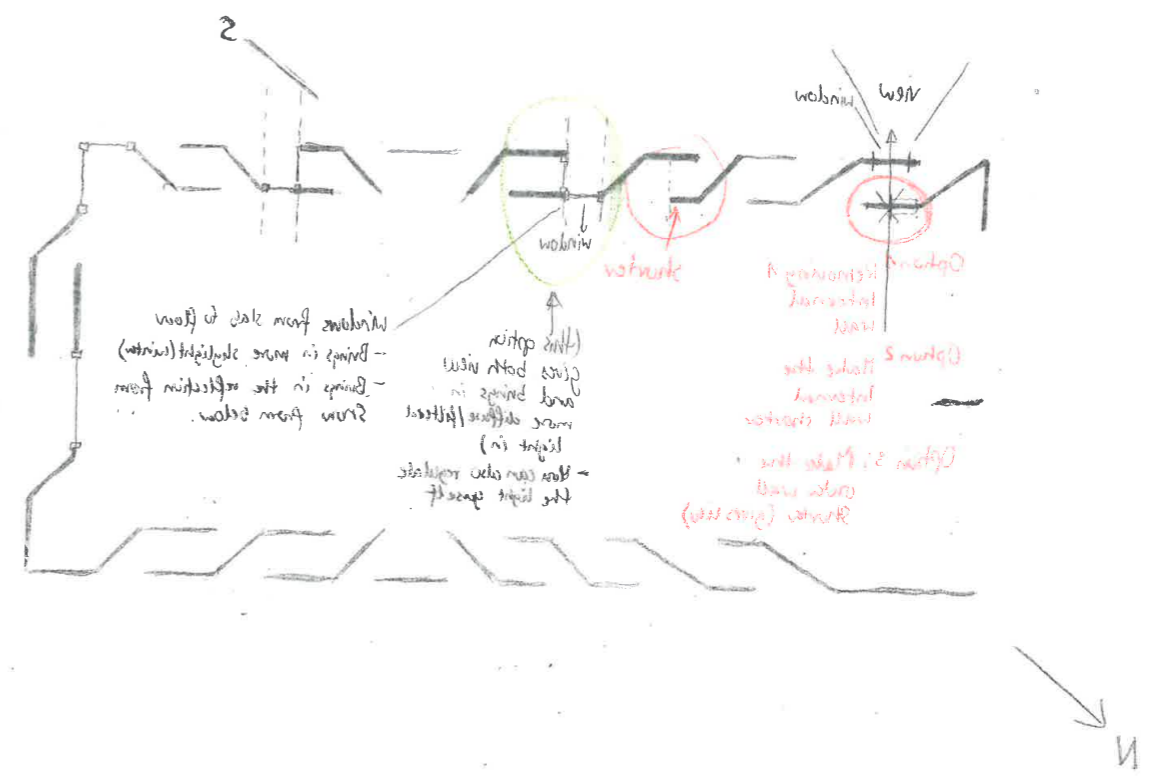

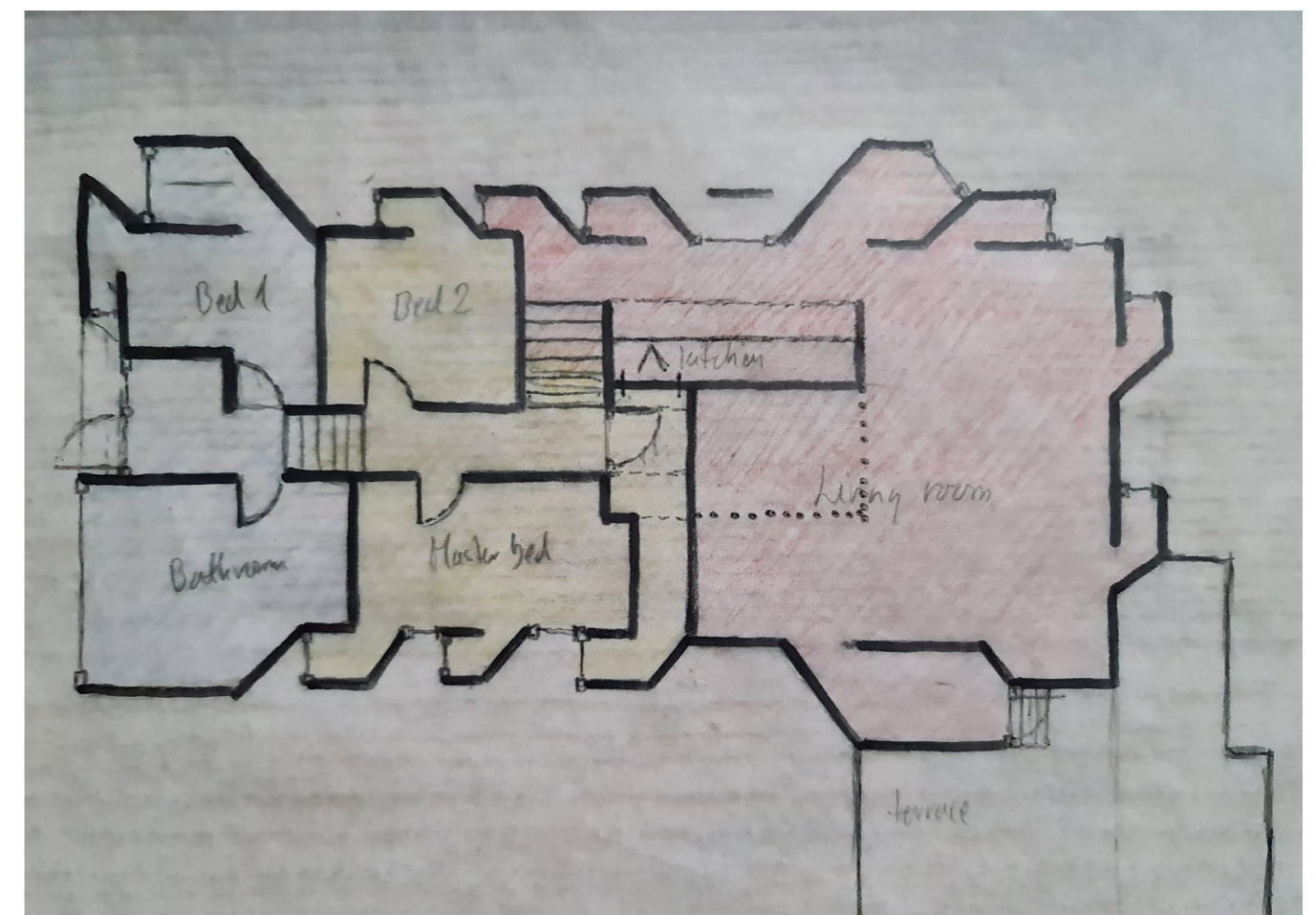
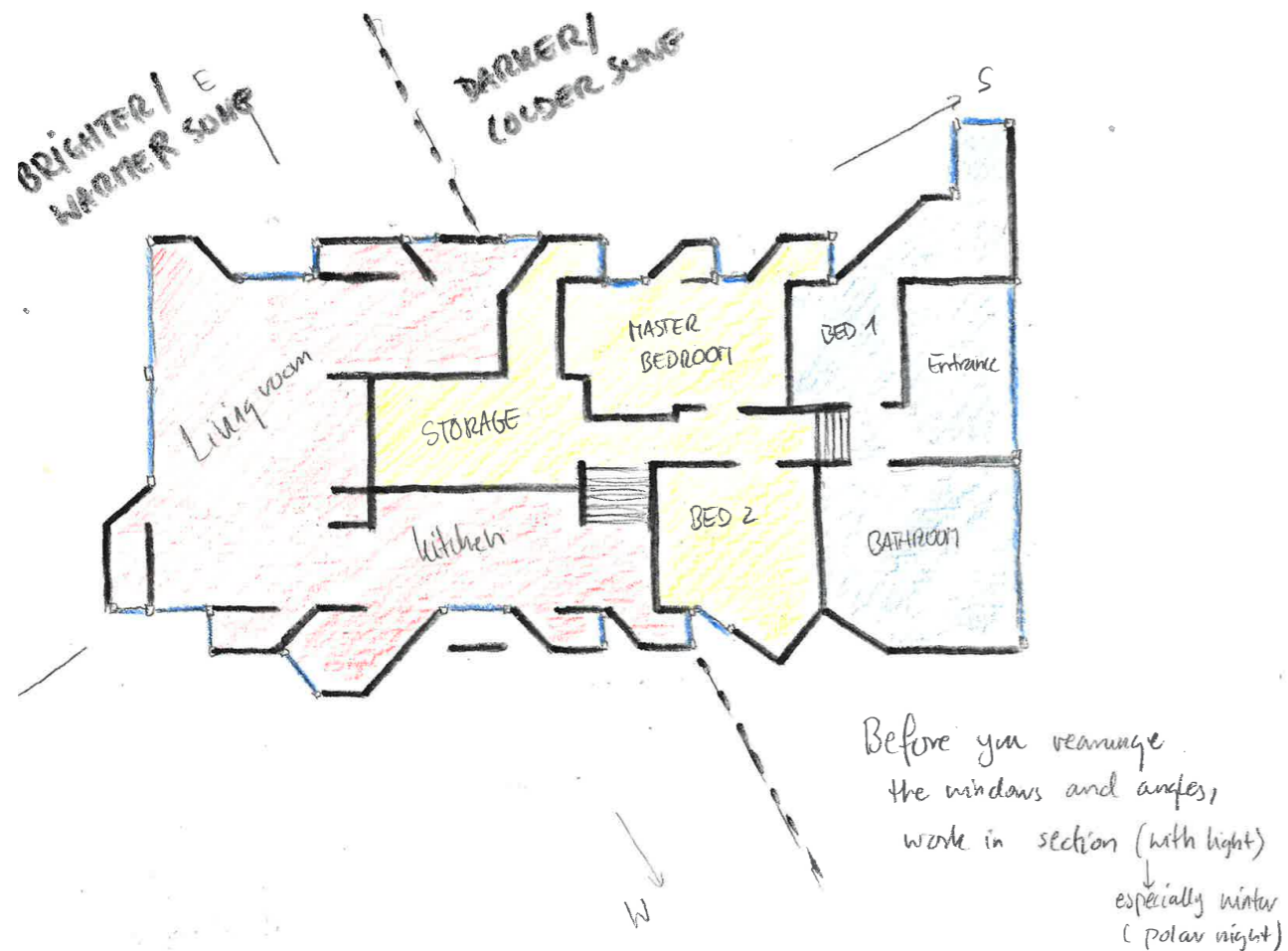
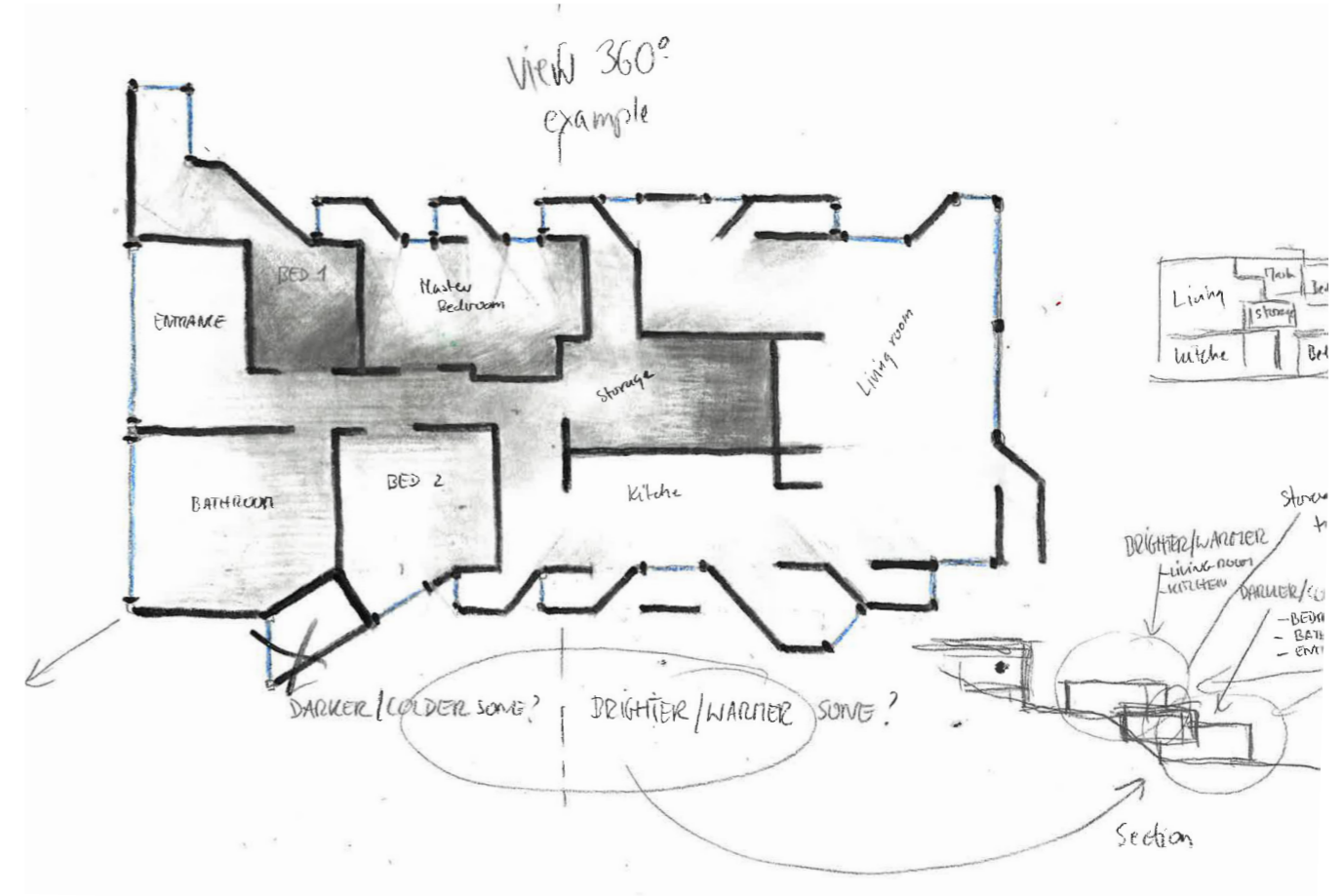
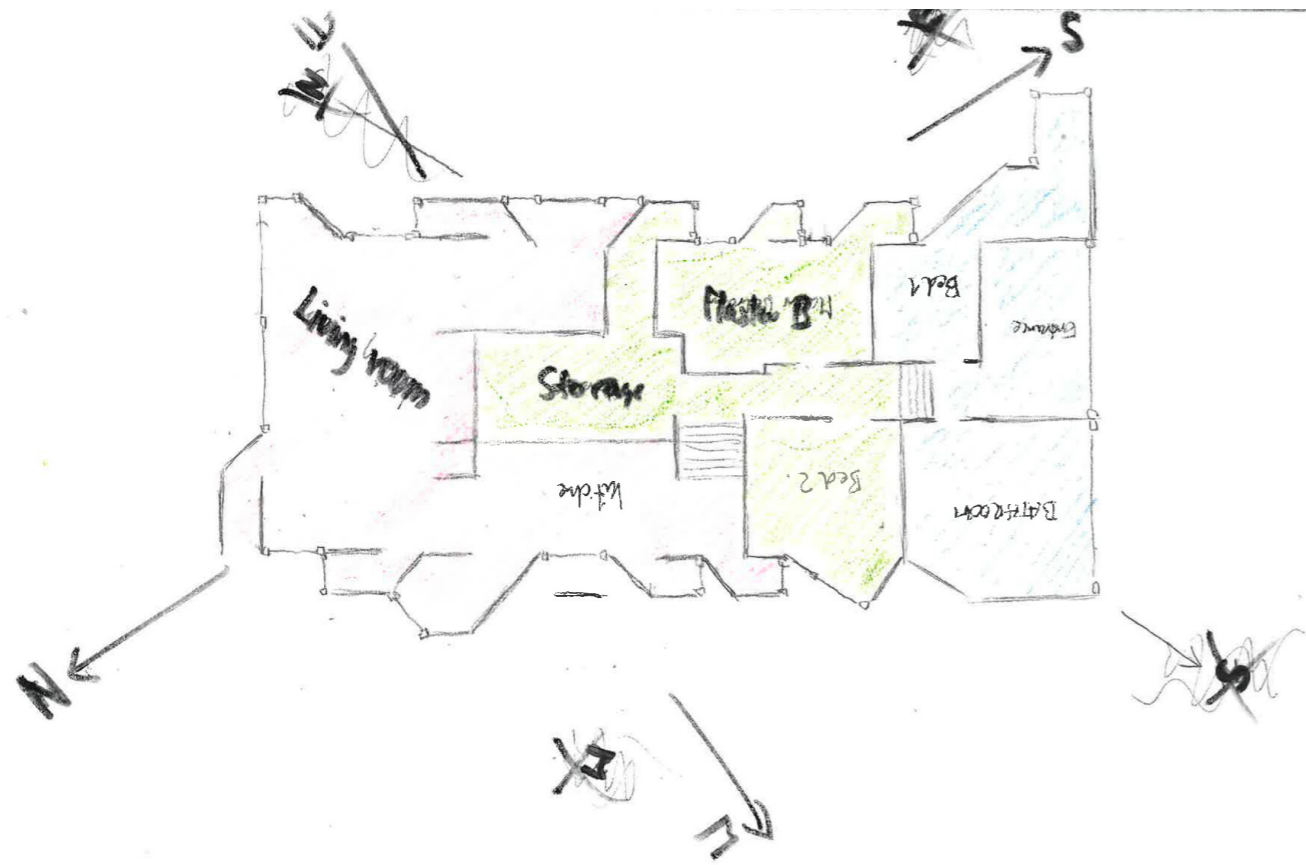

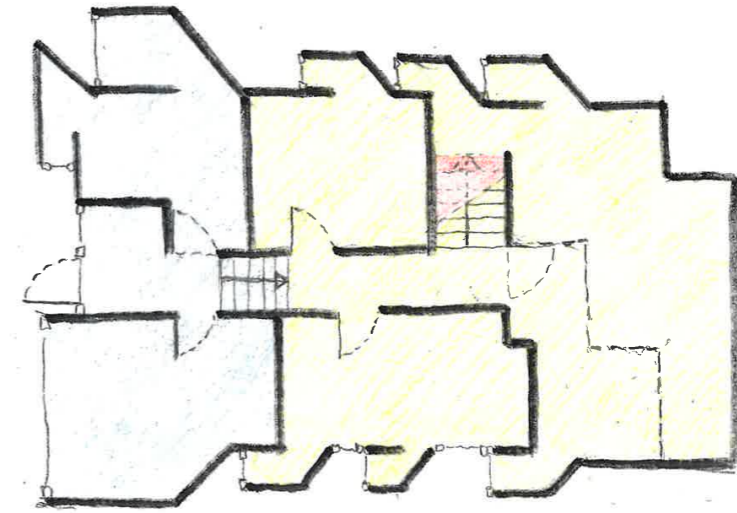
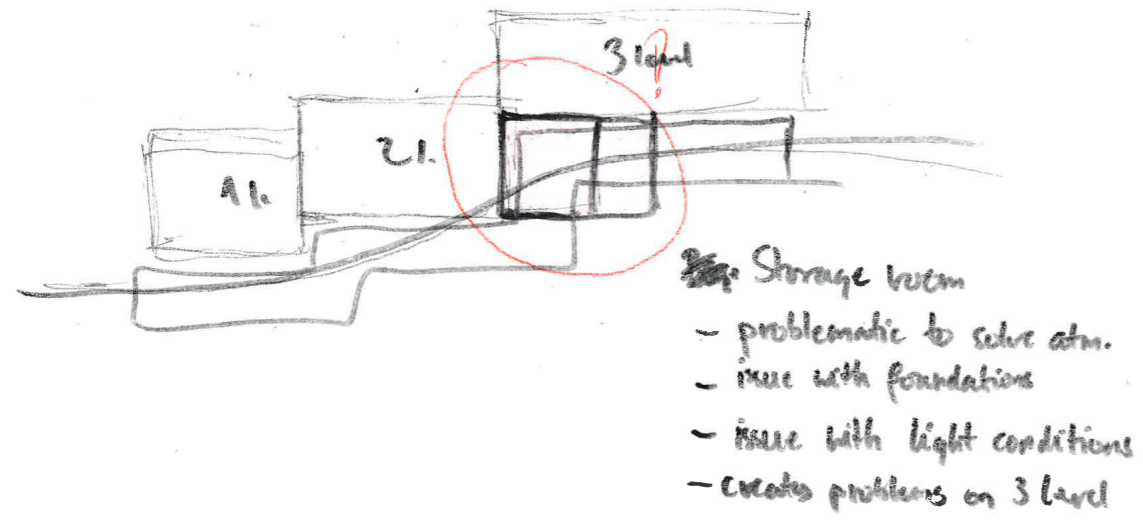

foundations

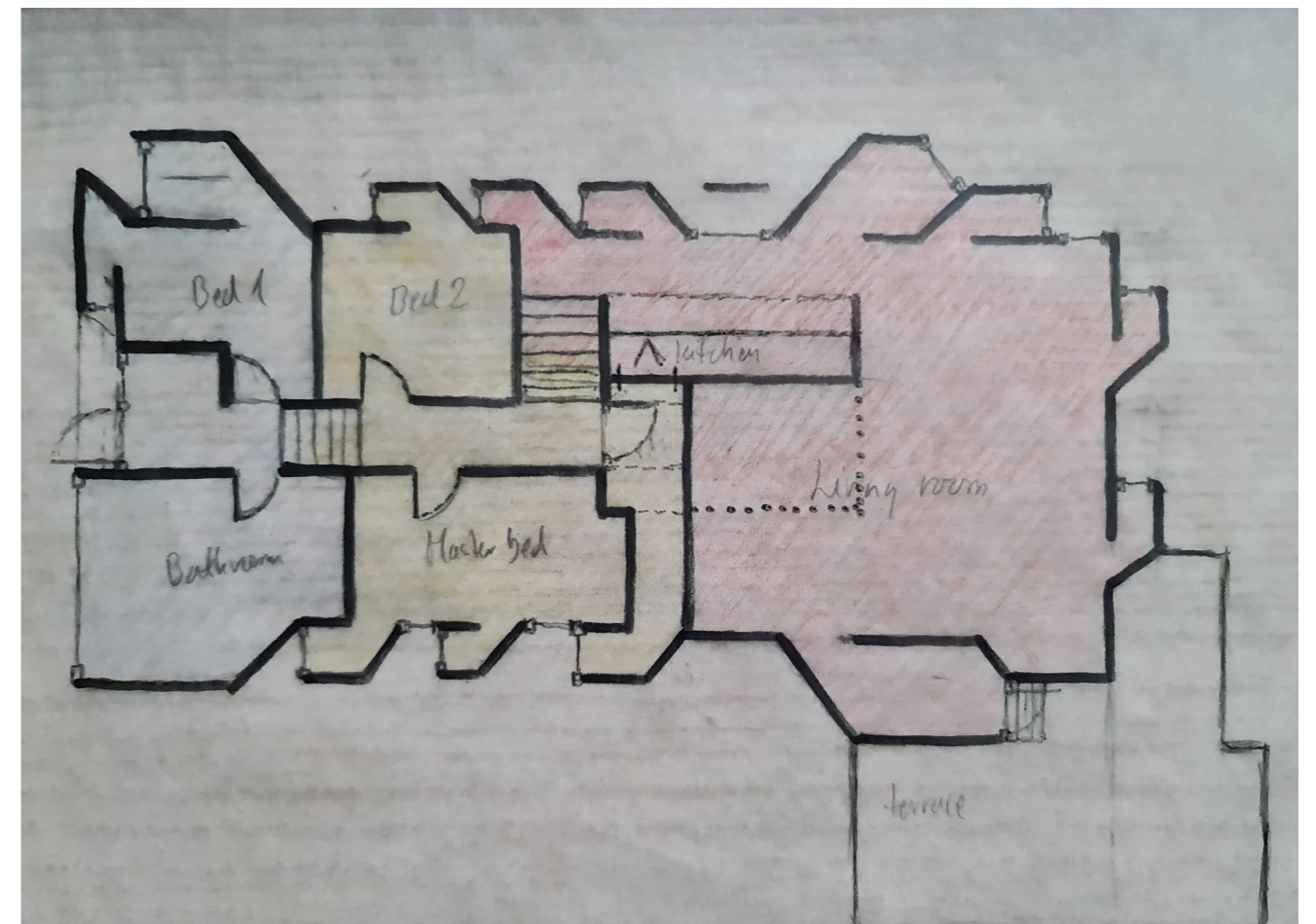
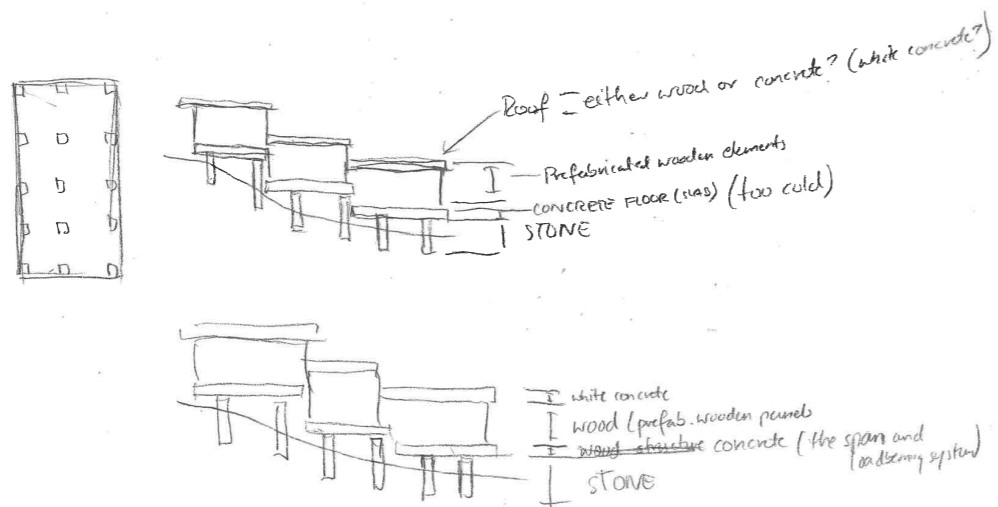

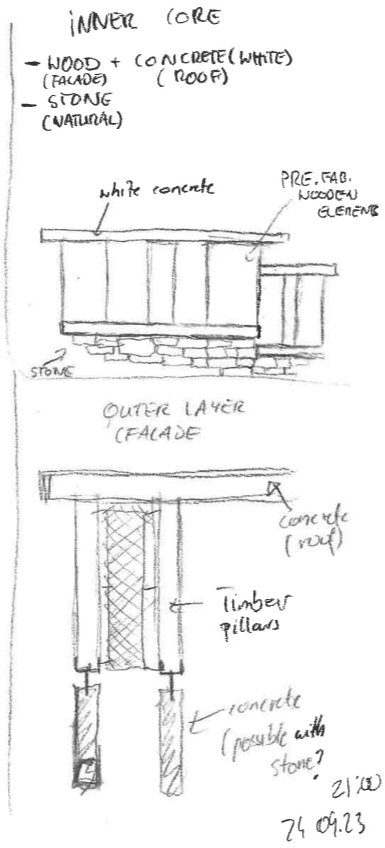
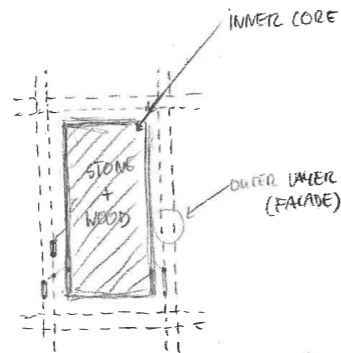
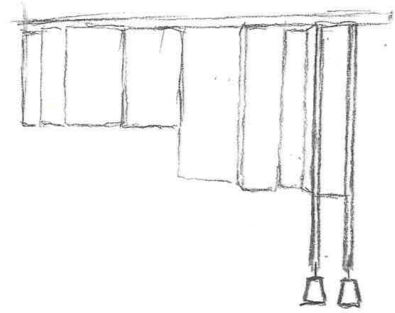

WOOD

STONE or CONCRETE

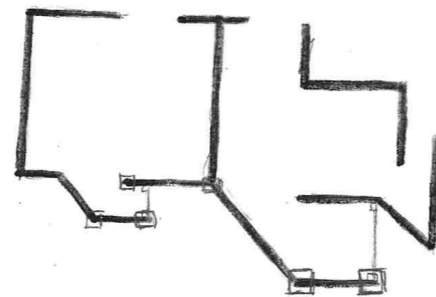
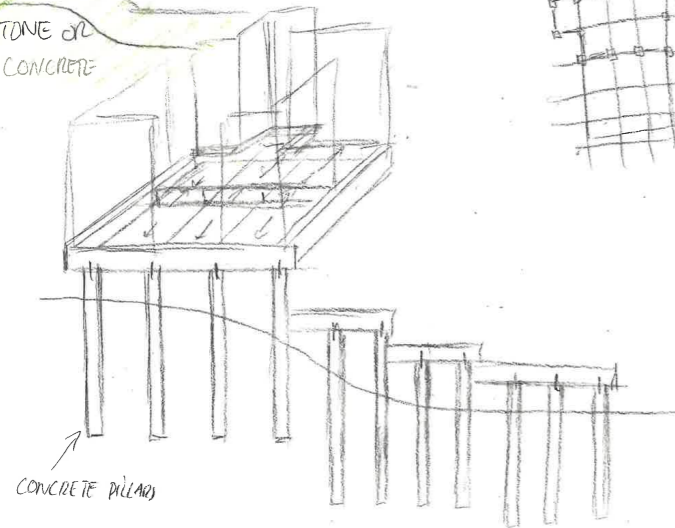
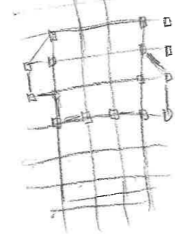

24.0

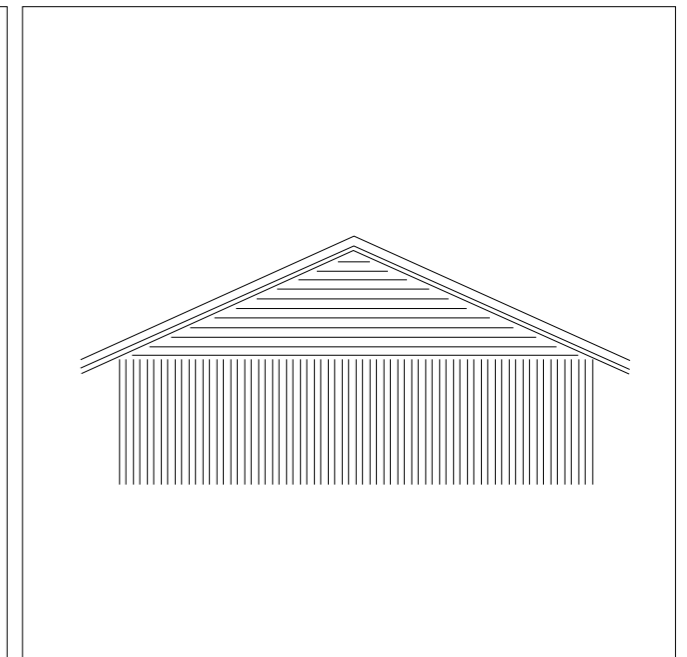
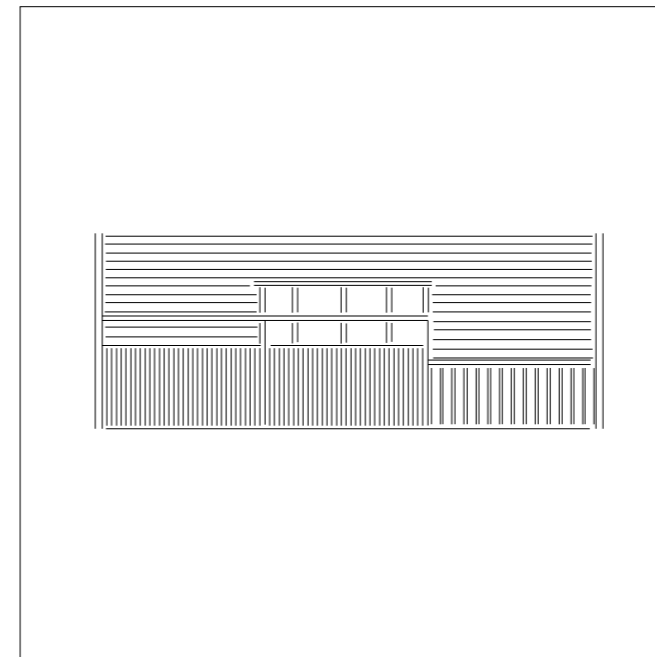
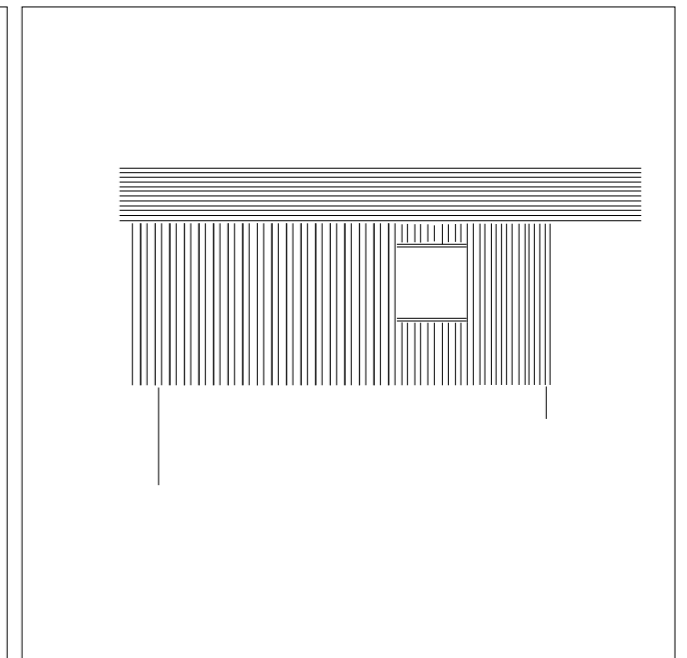
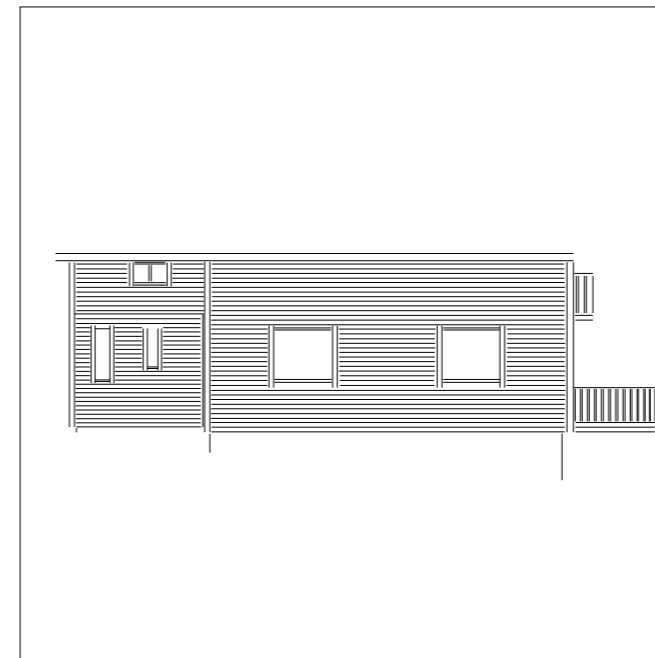
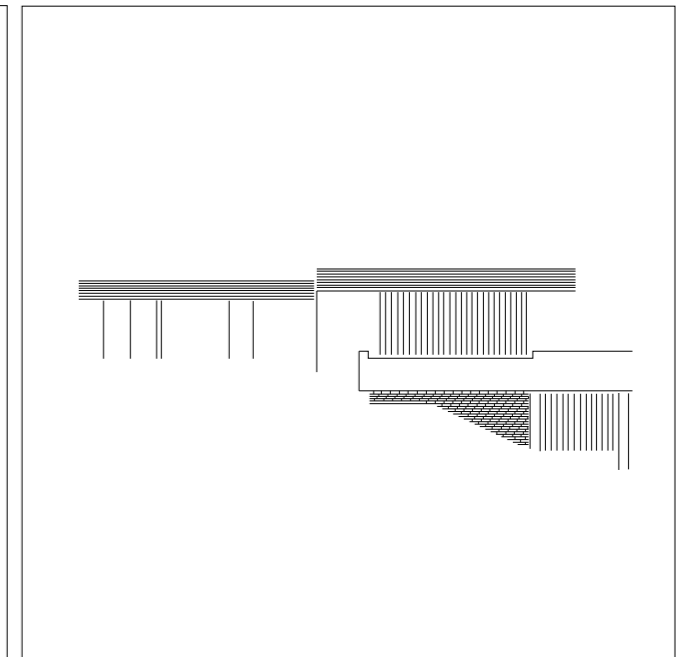
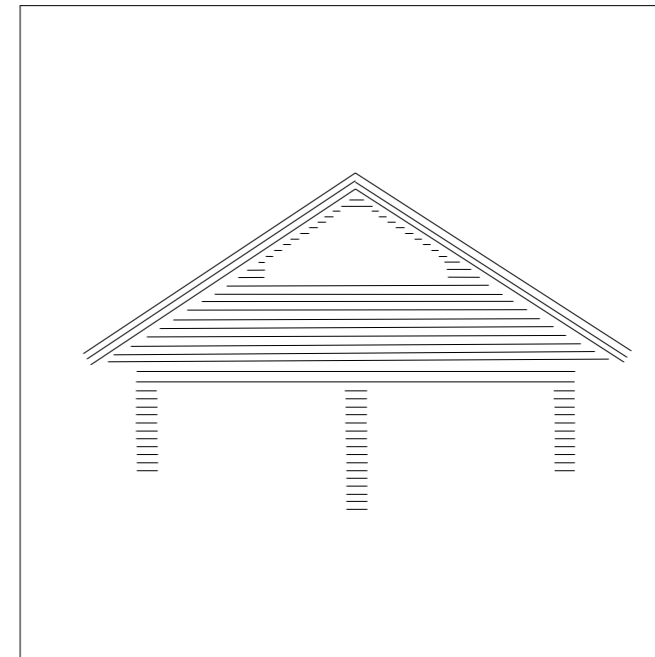

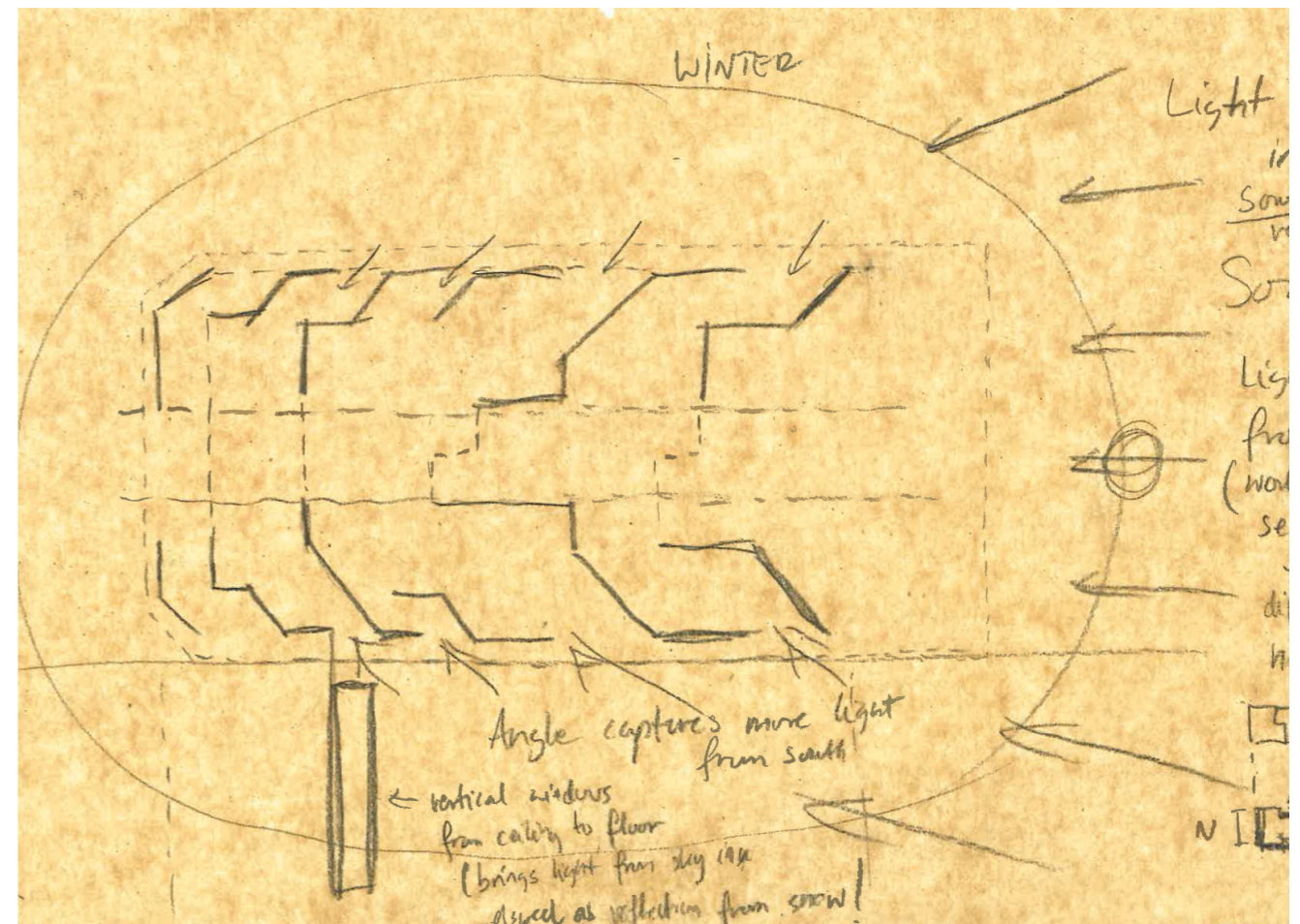
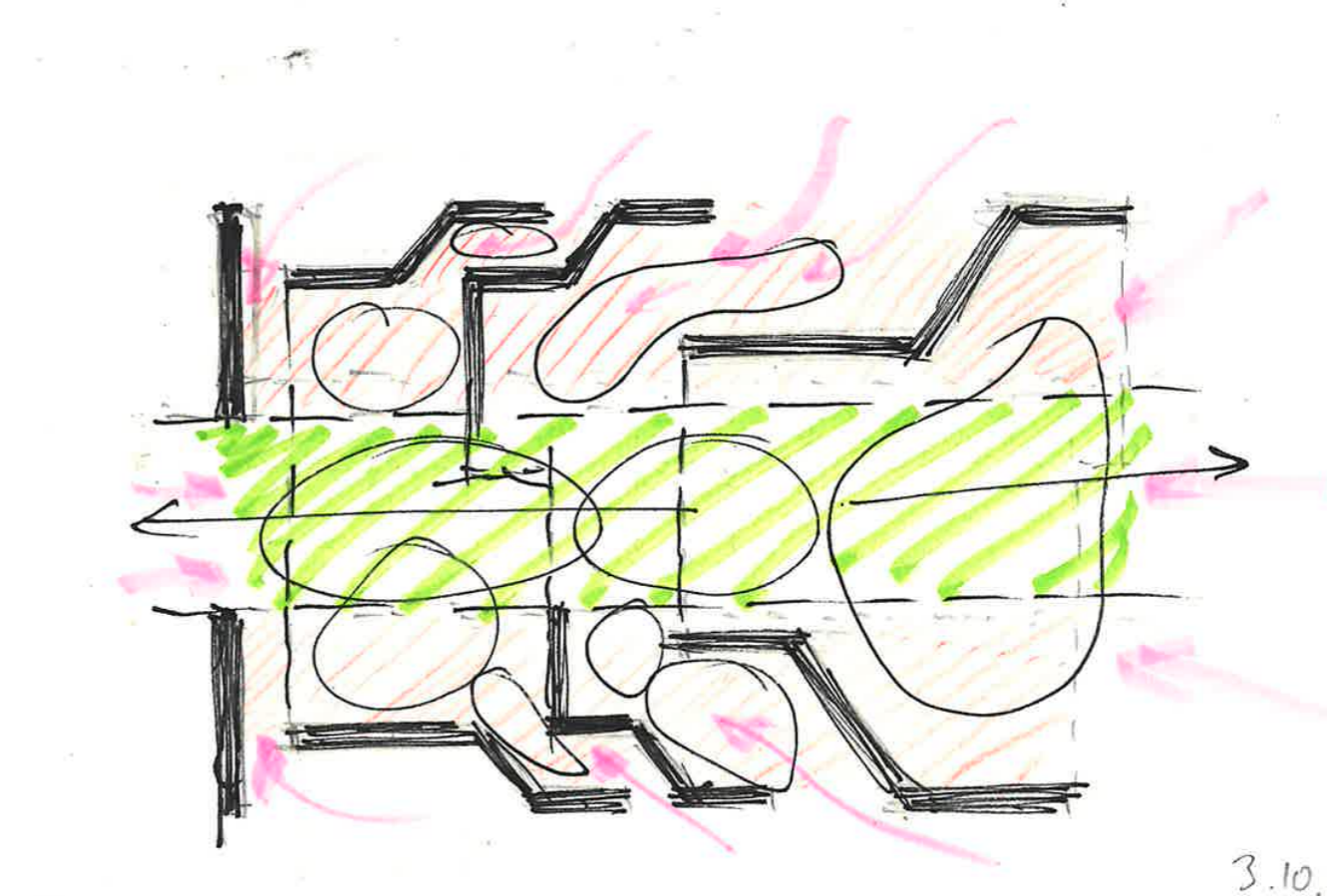
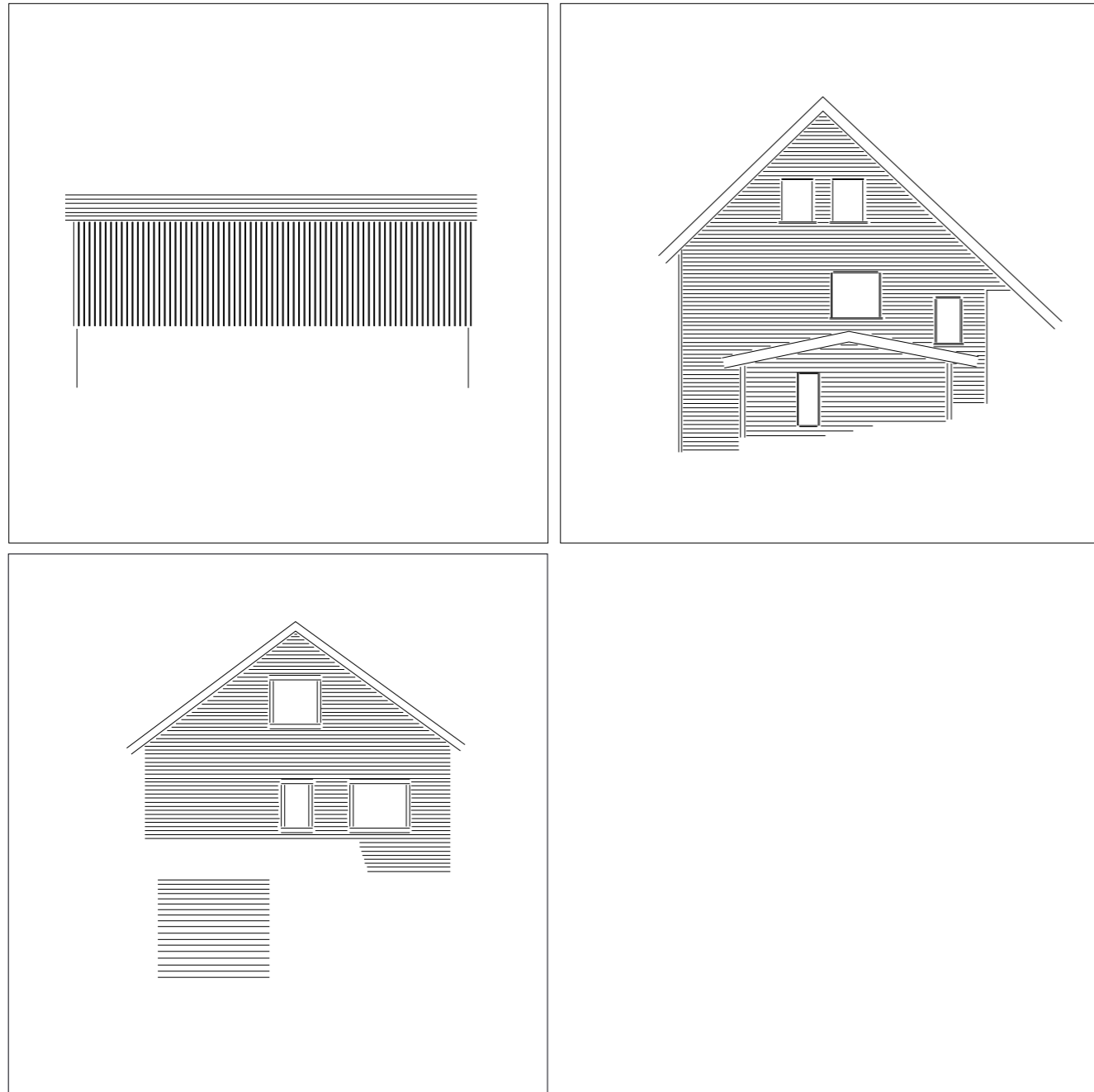

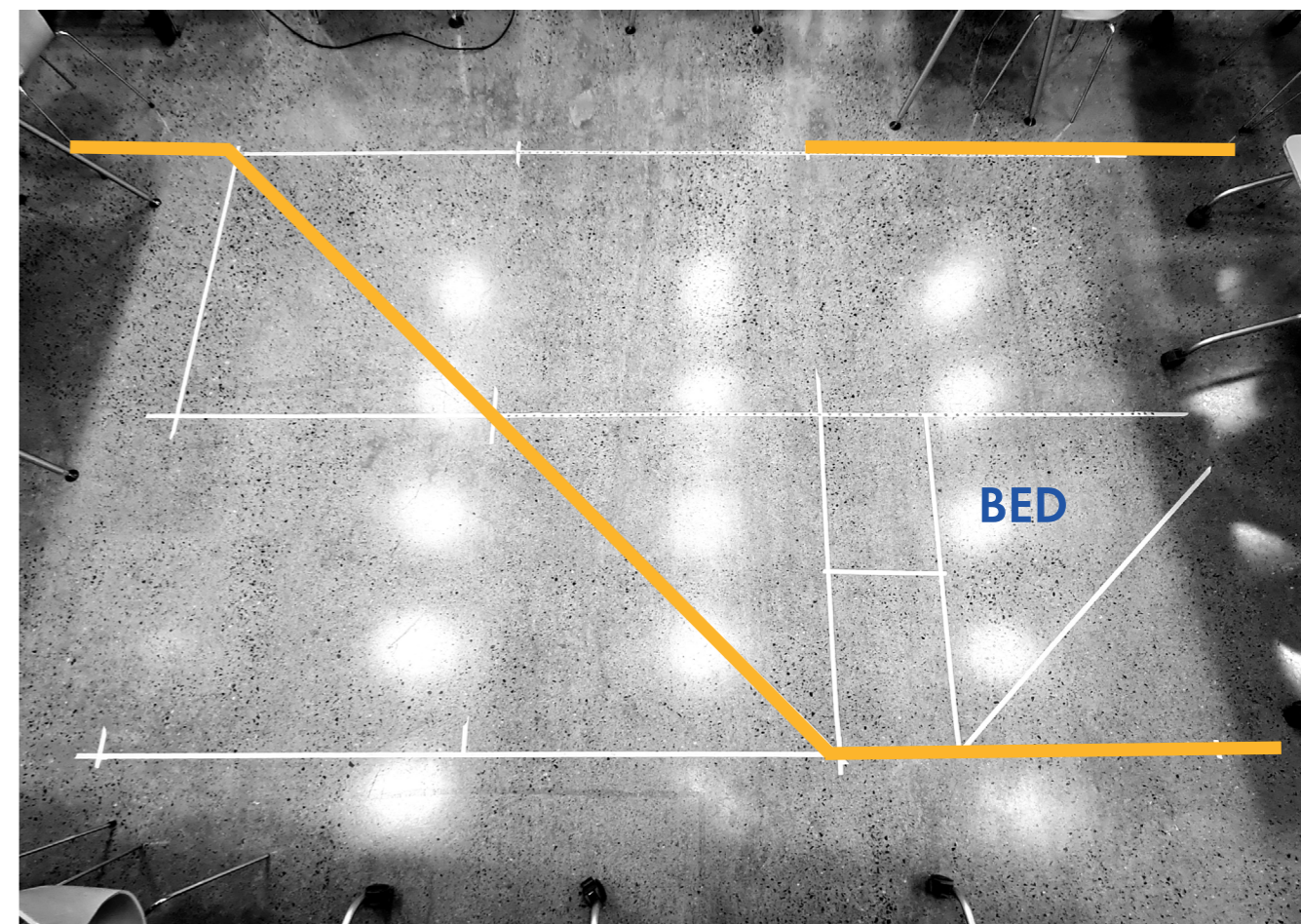
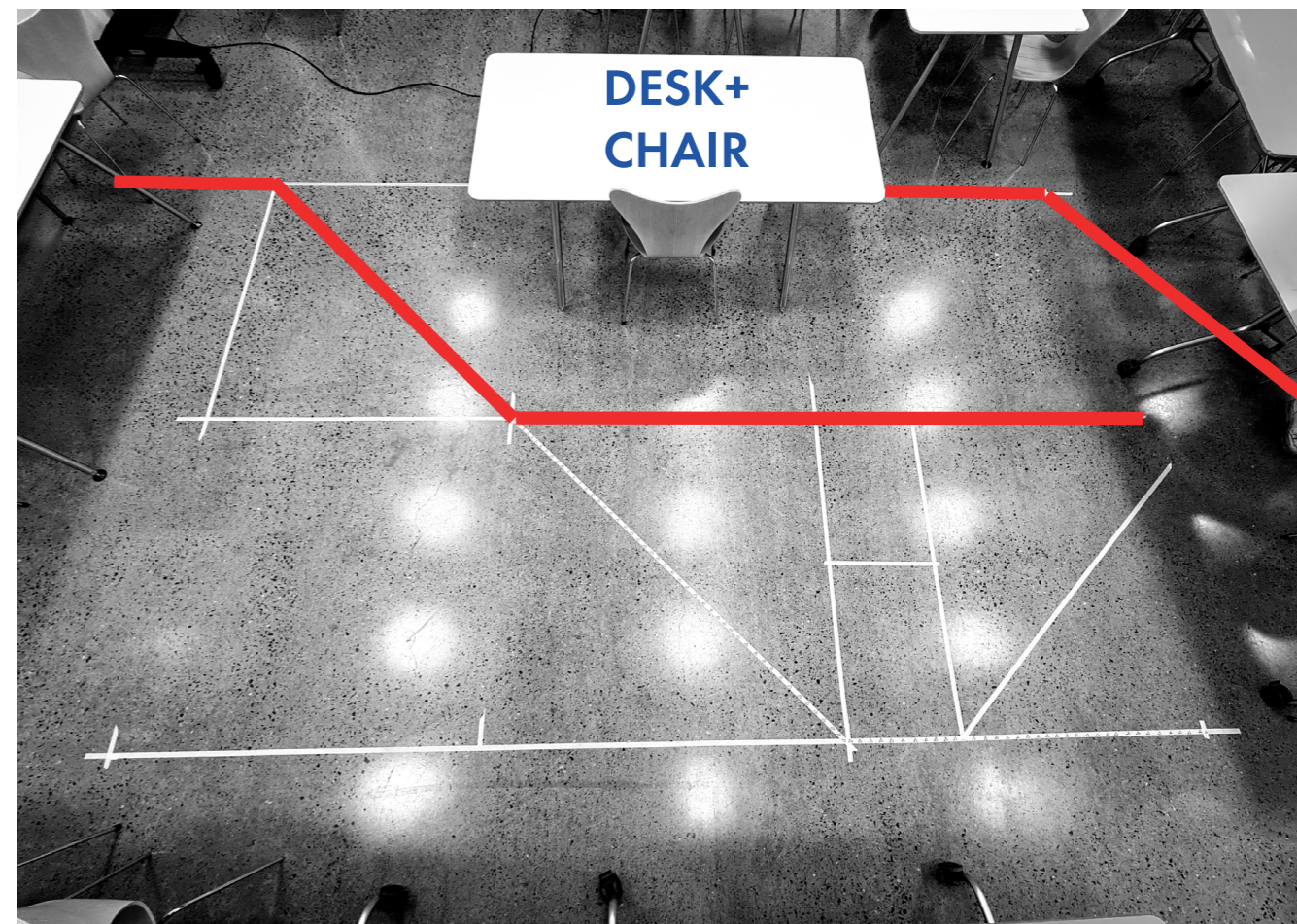
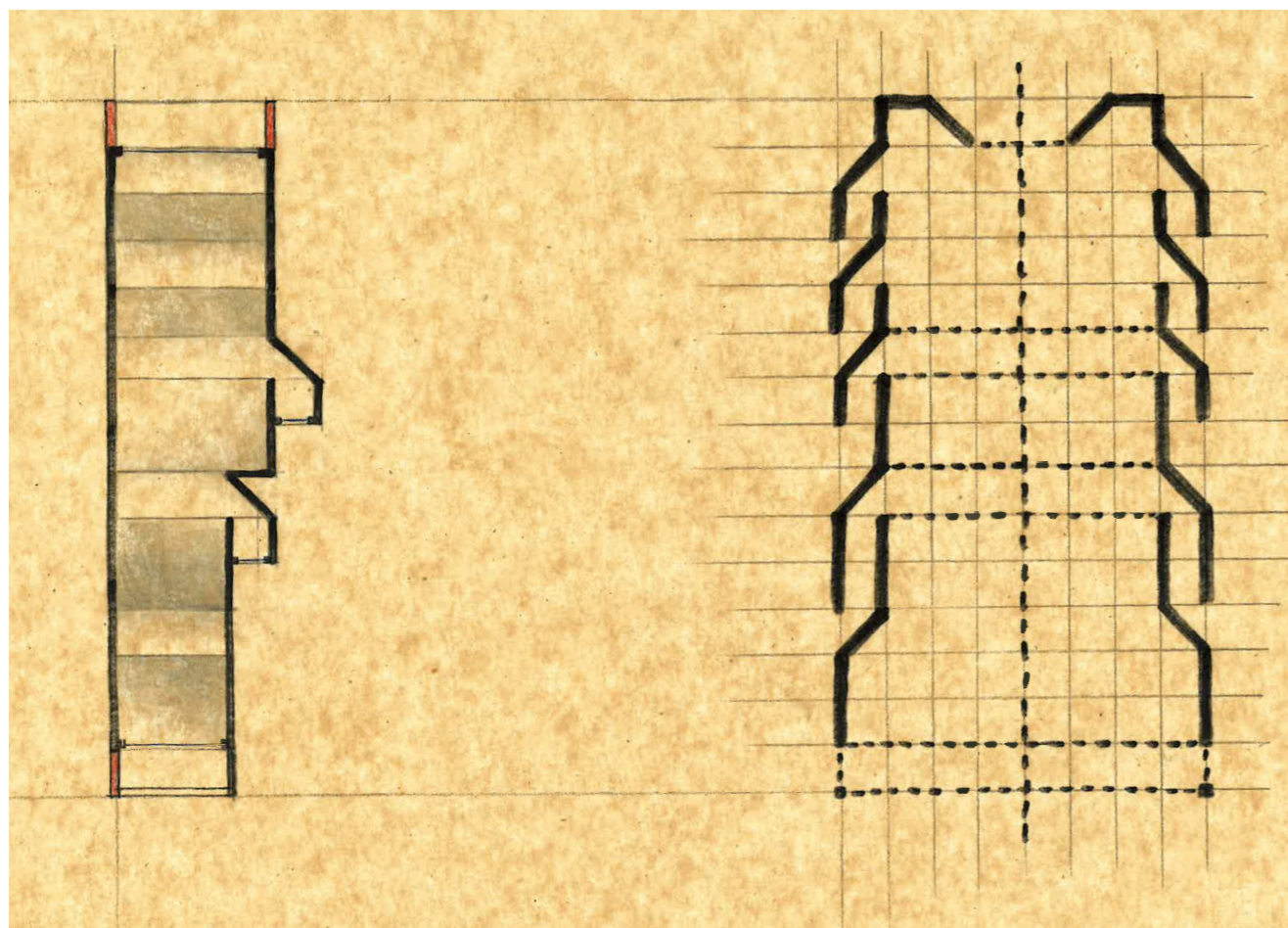
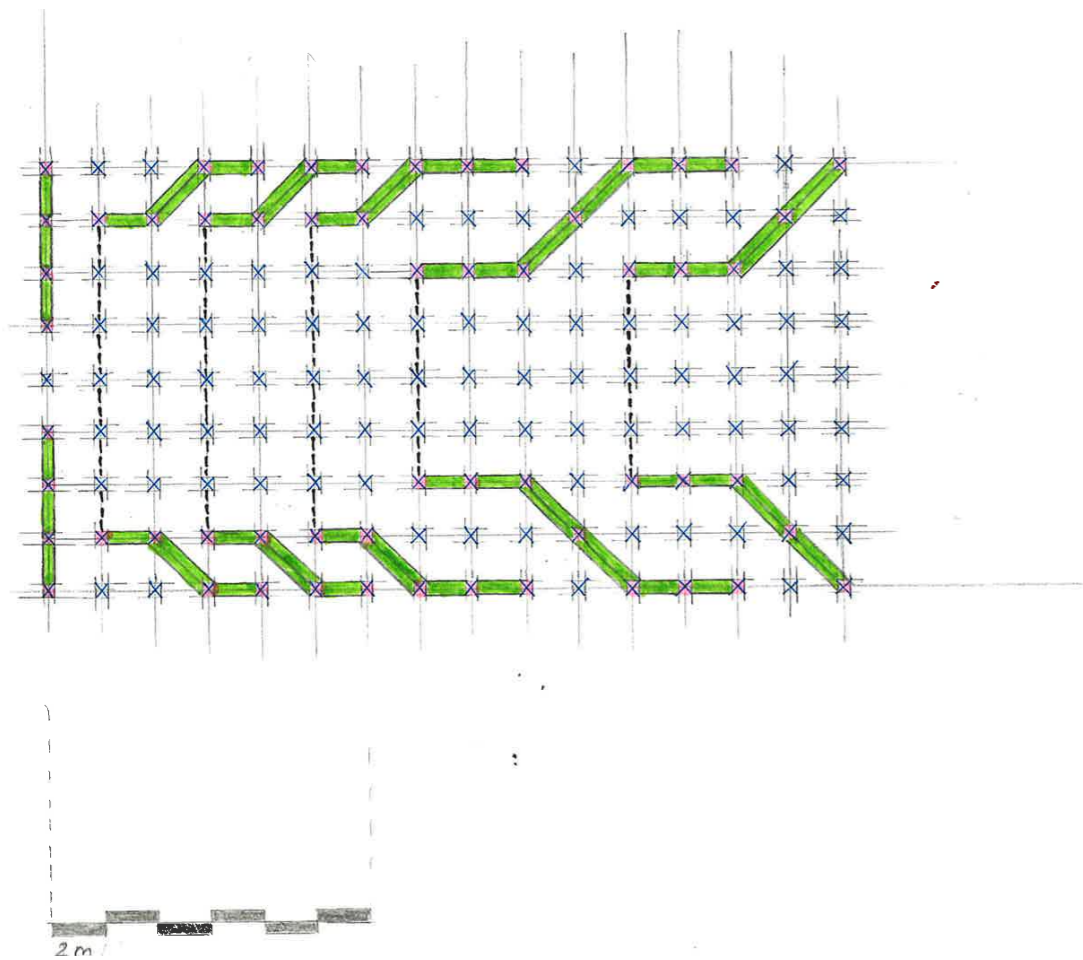

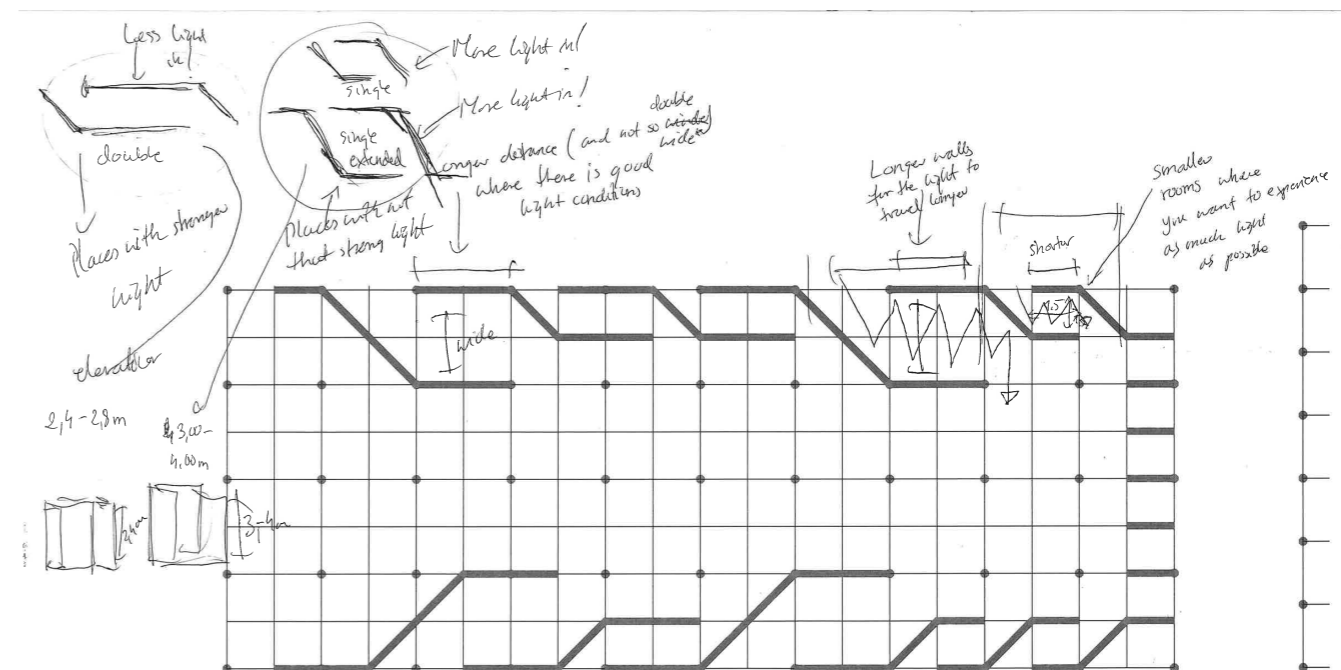
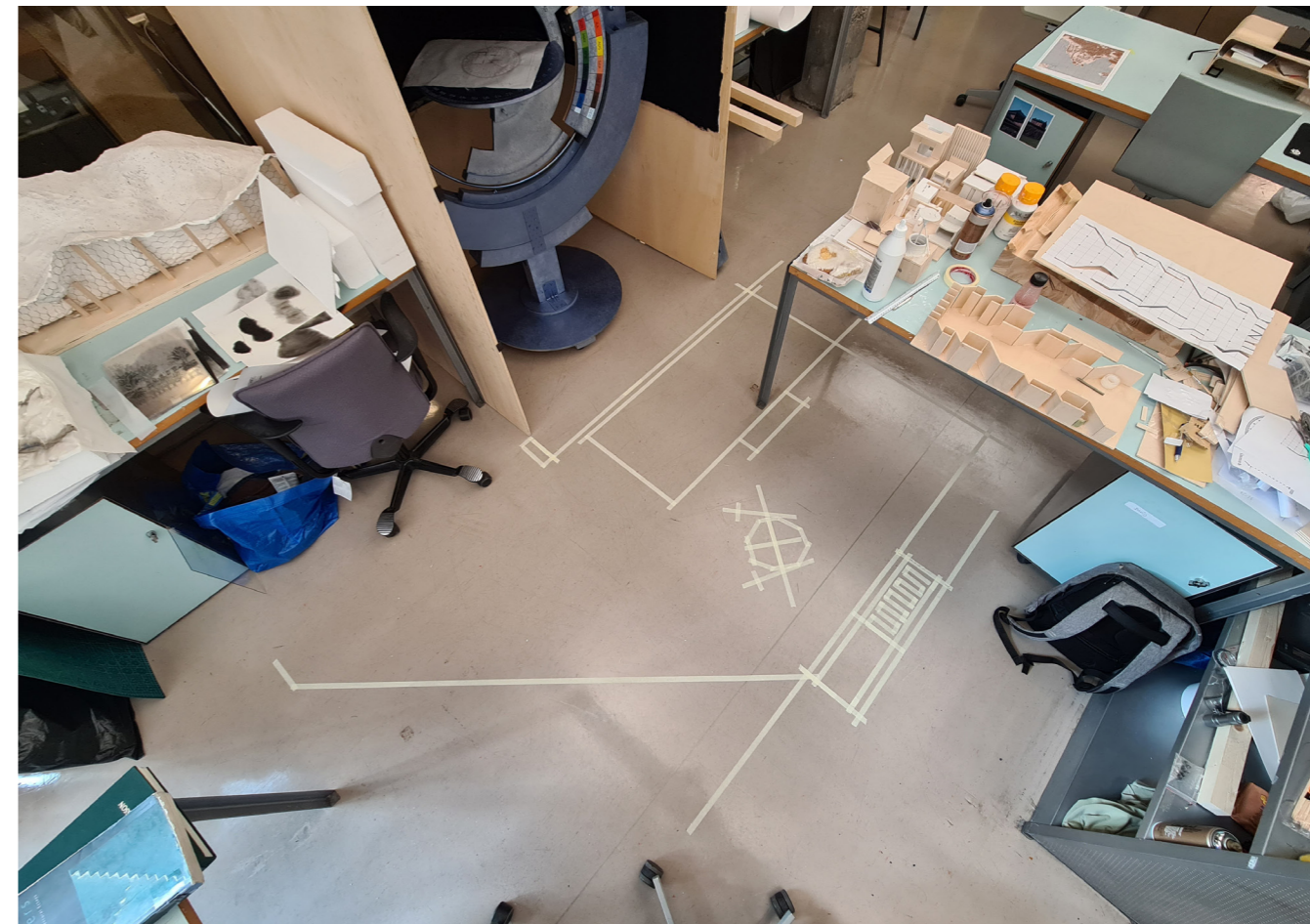
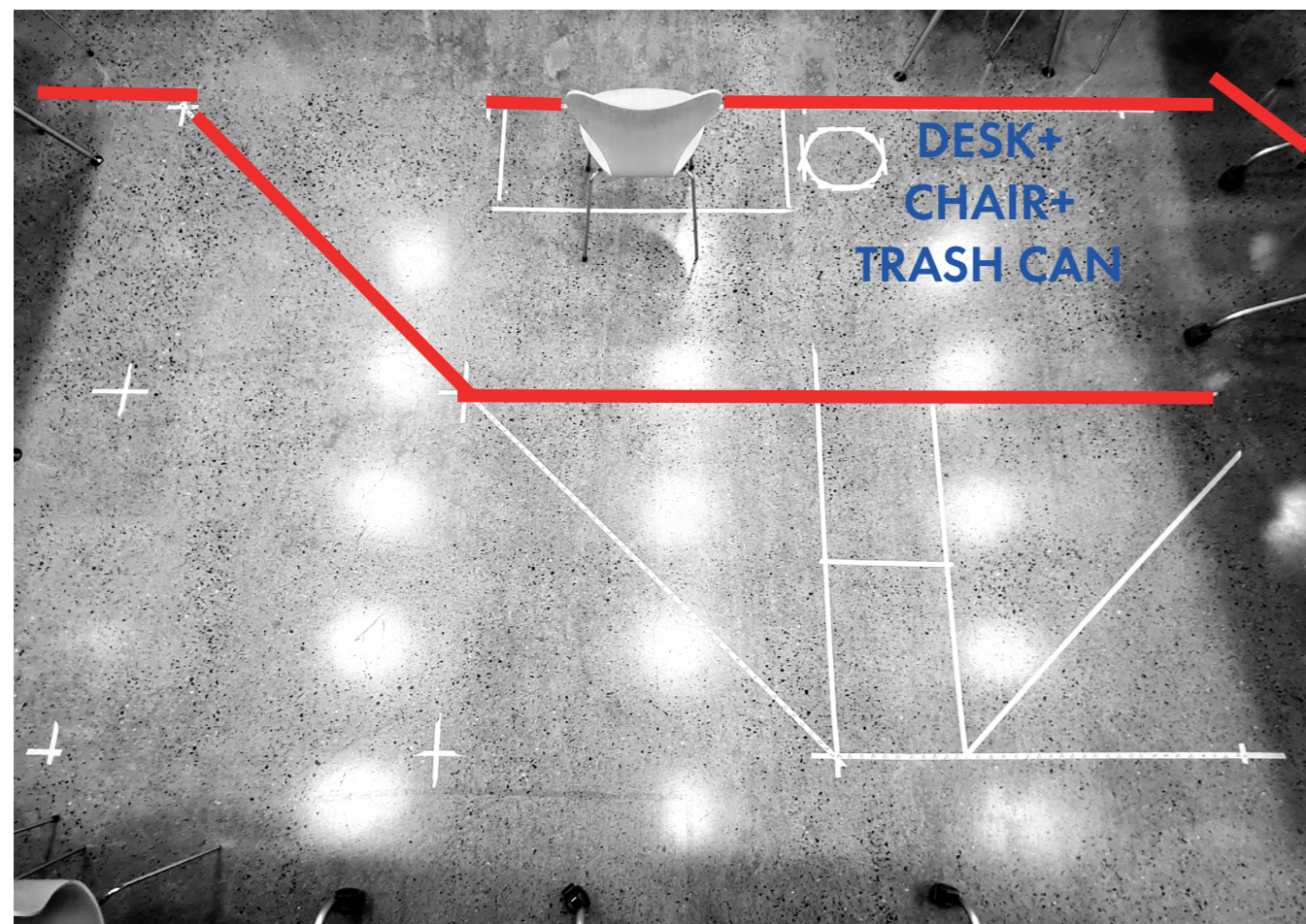
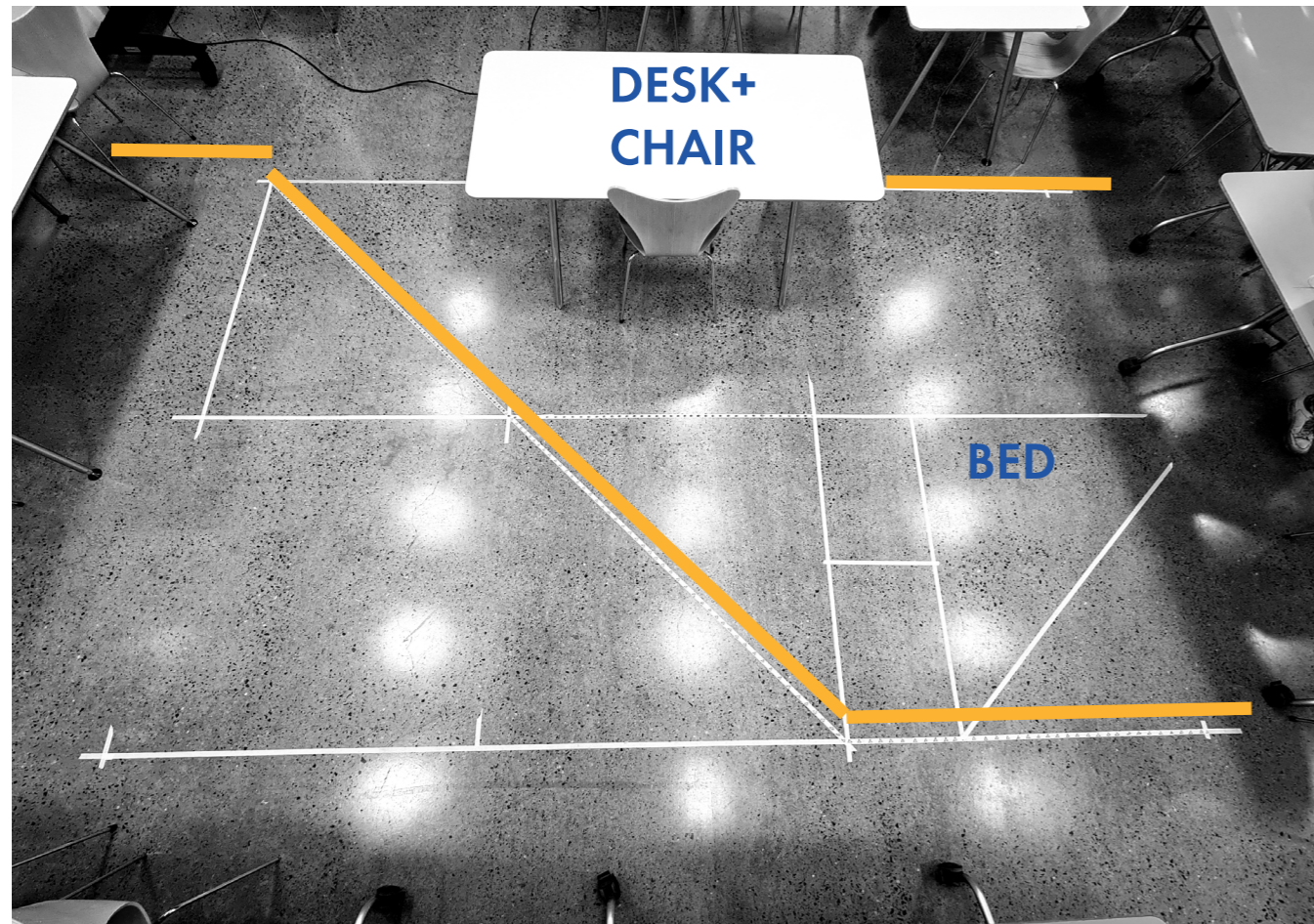

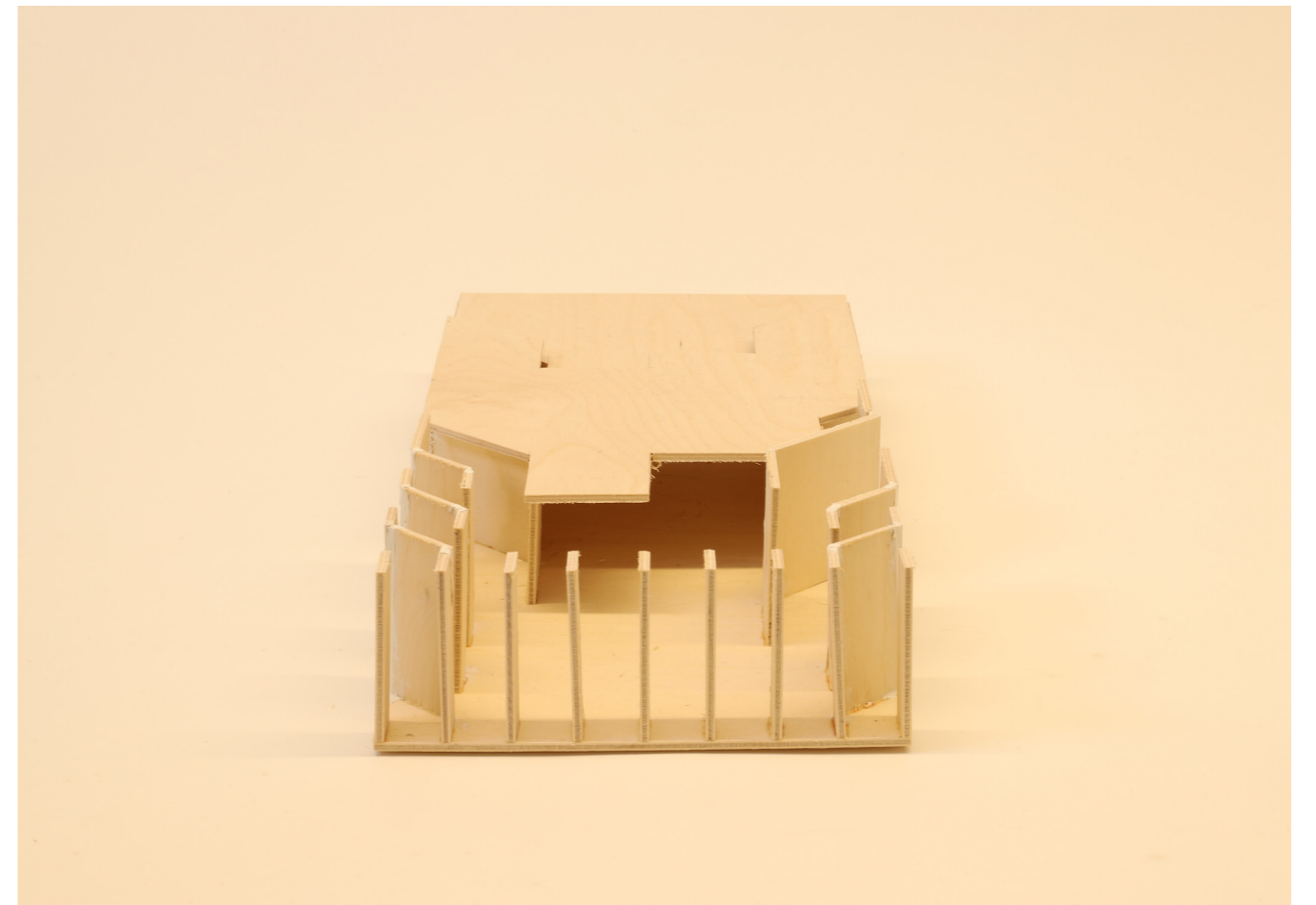
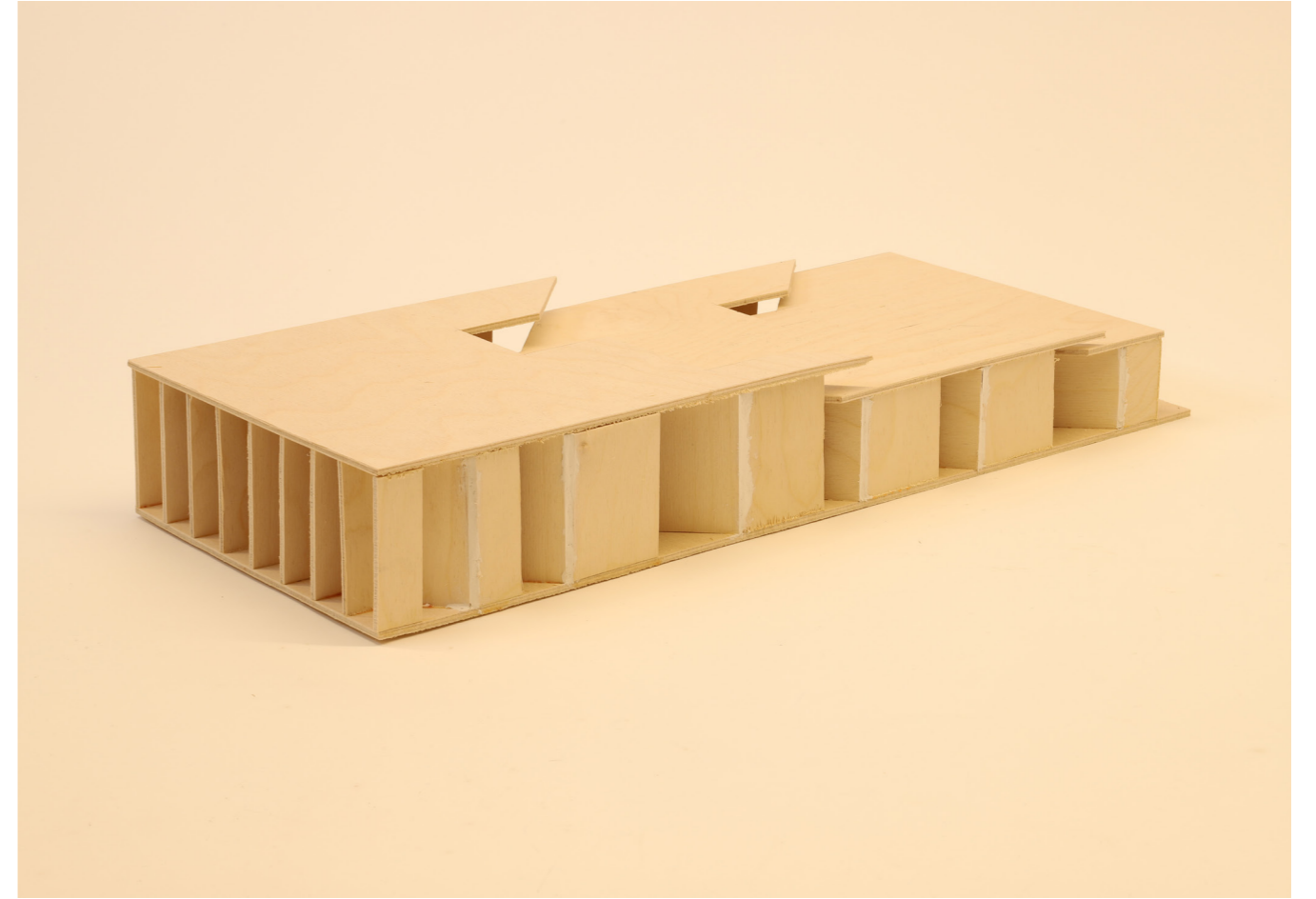
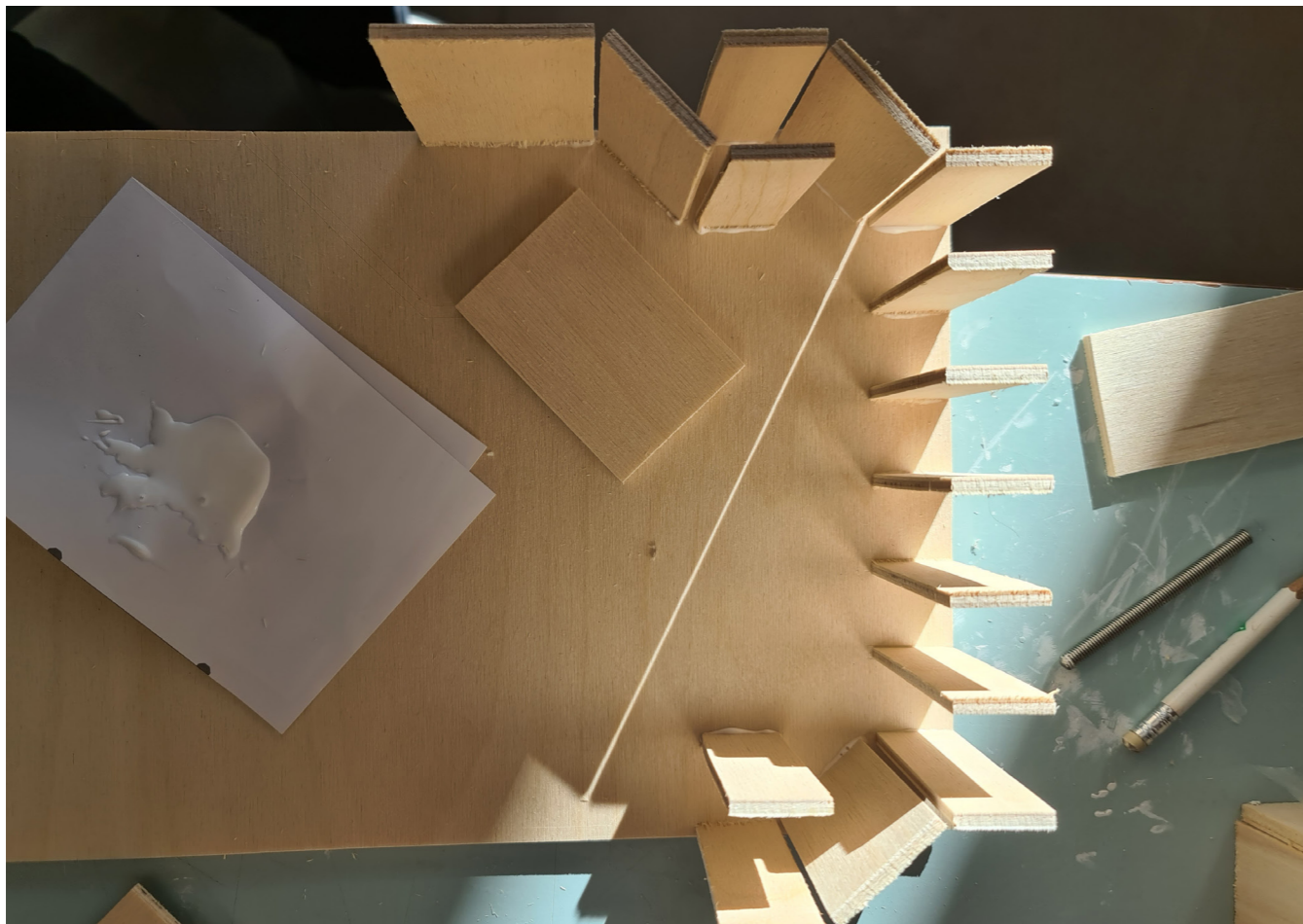

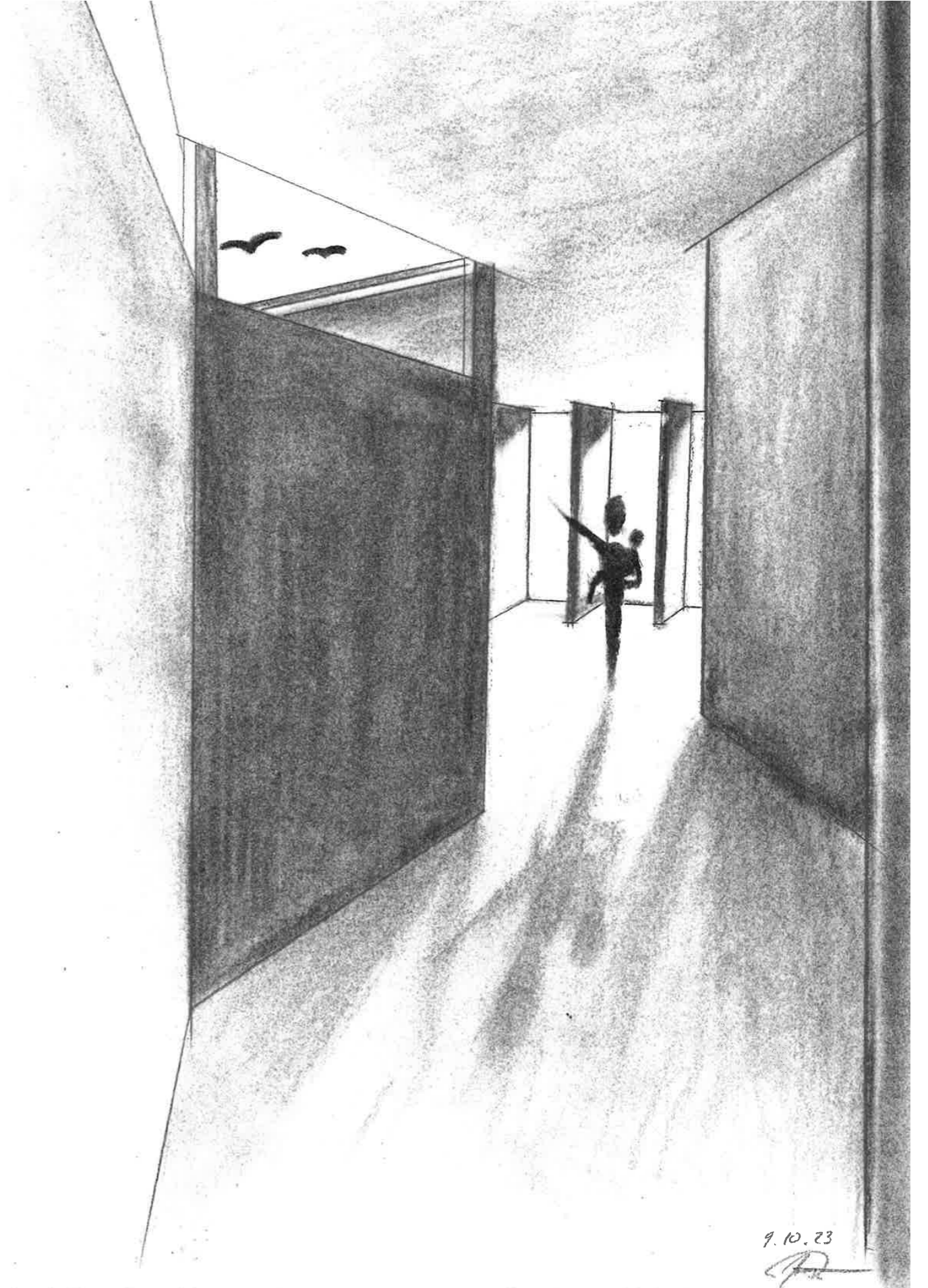
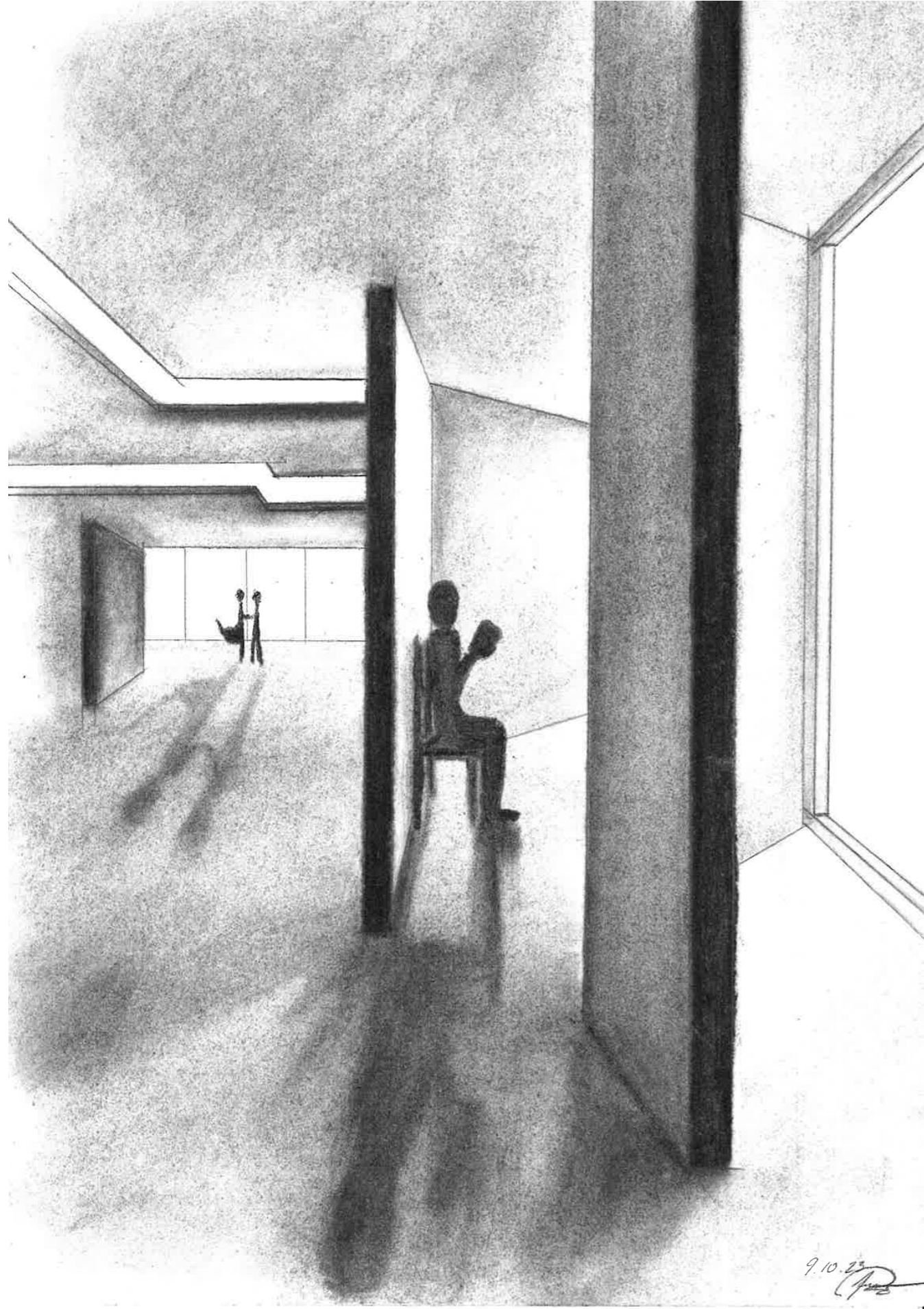

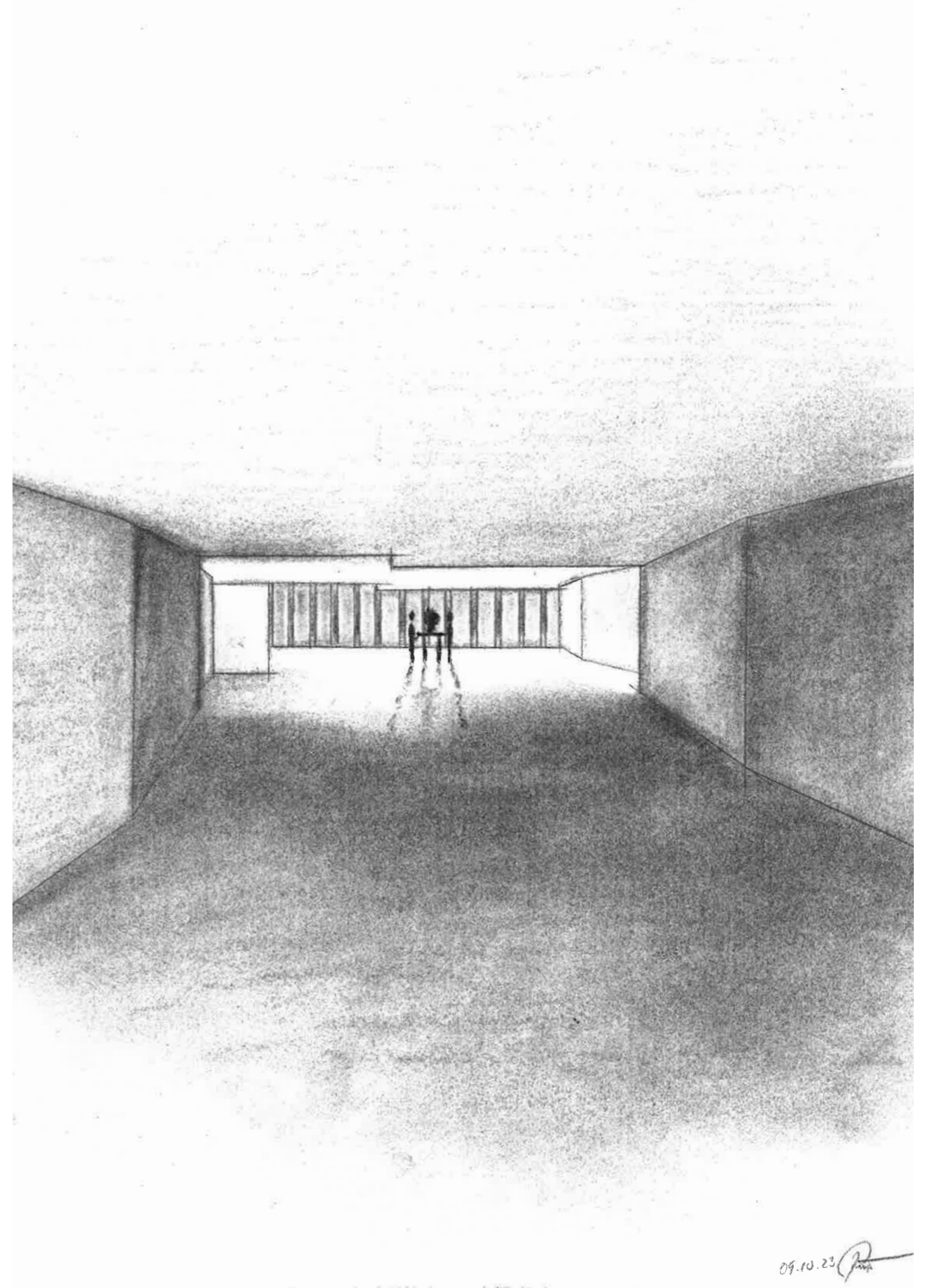
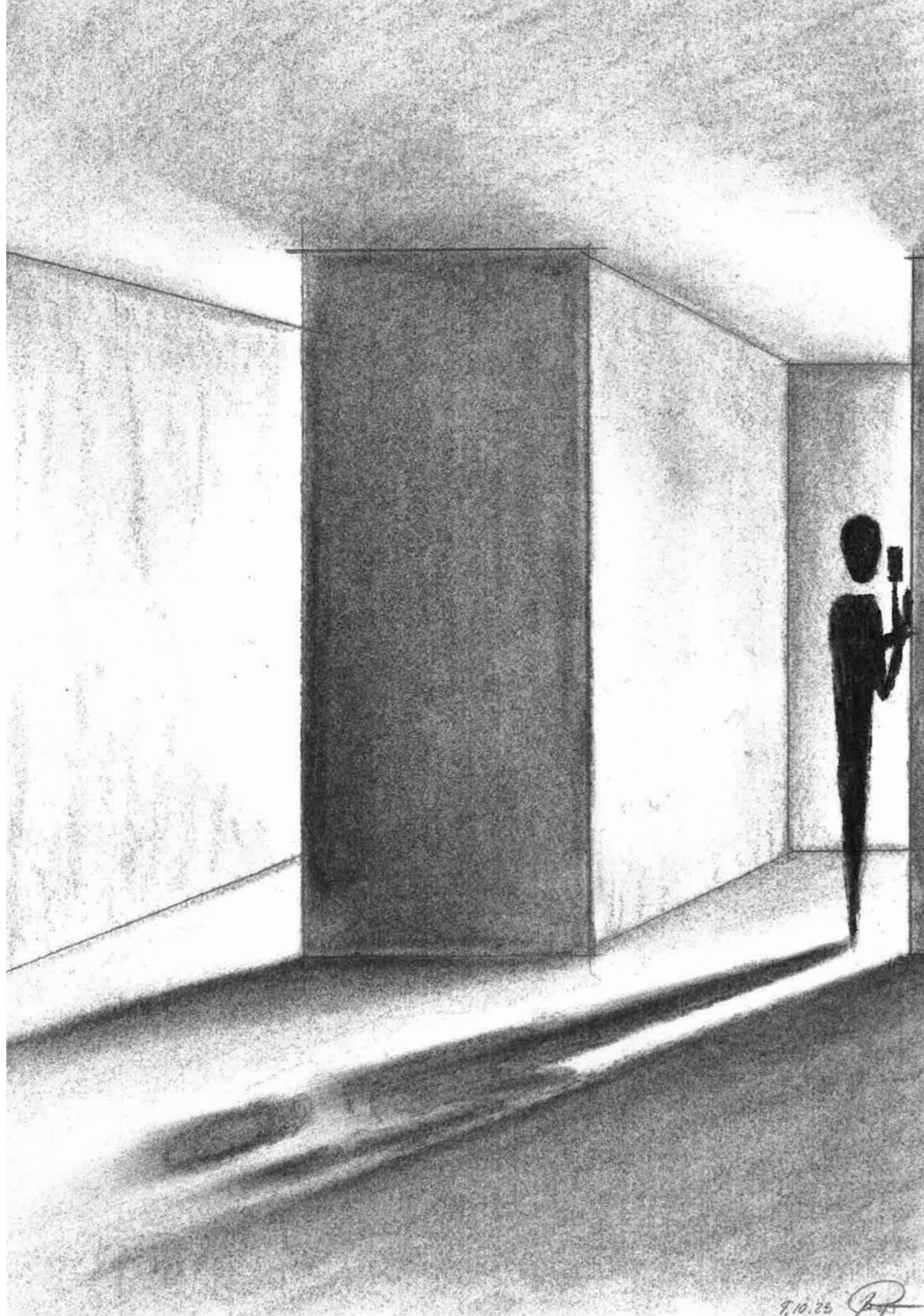

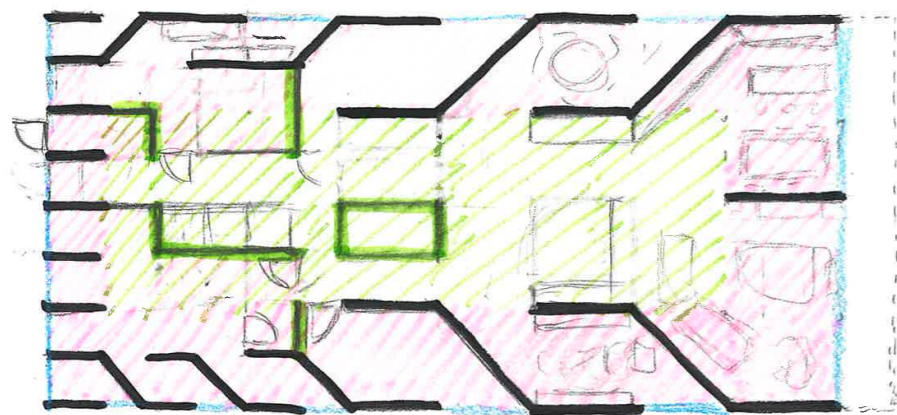
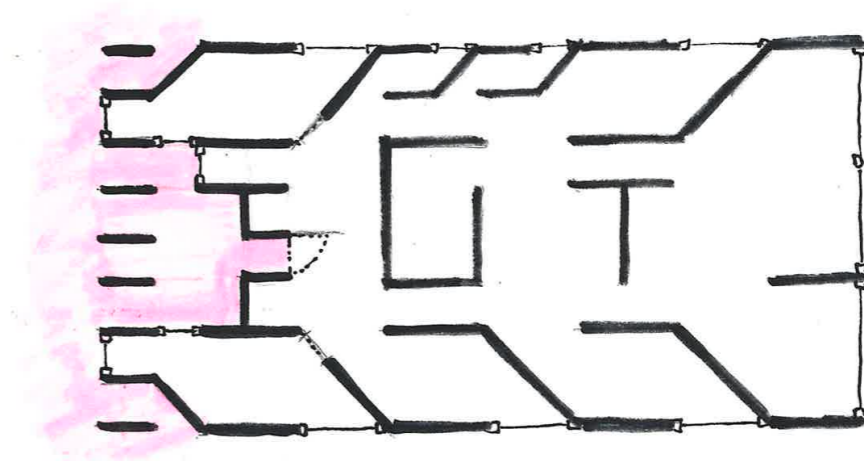
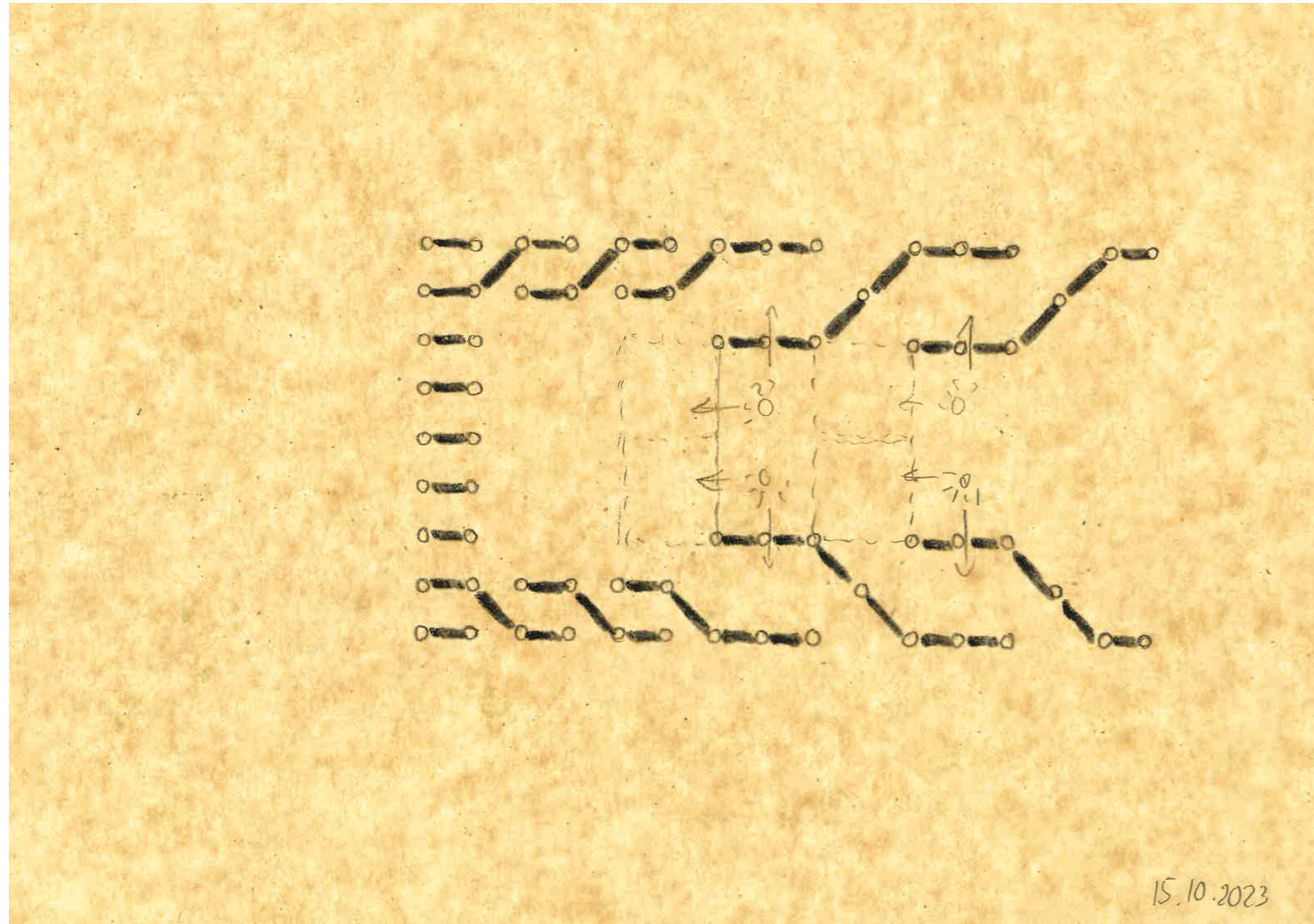

15.10.23

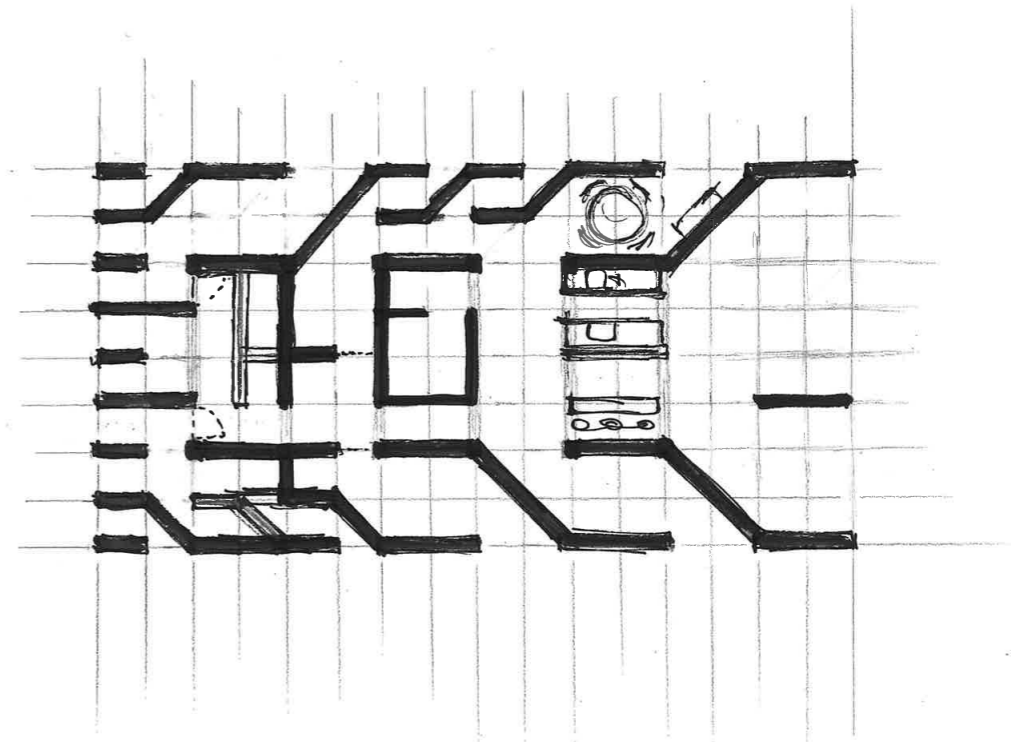

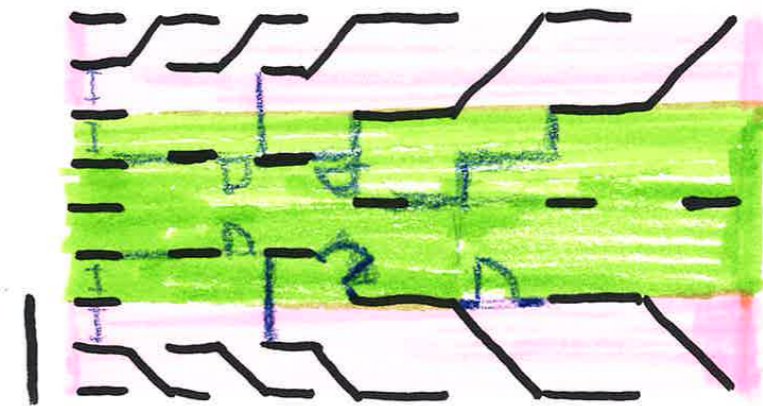
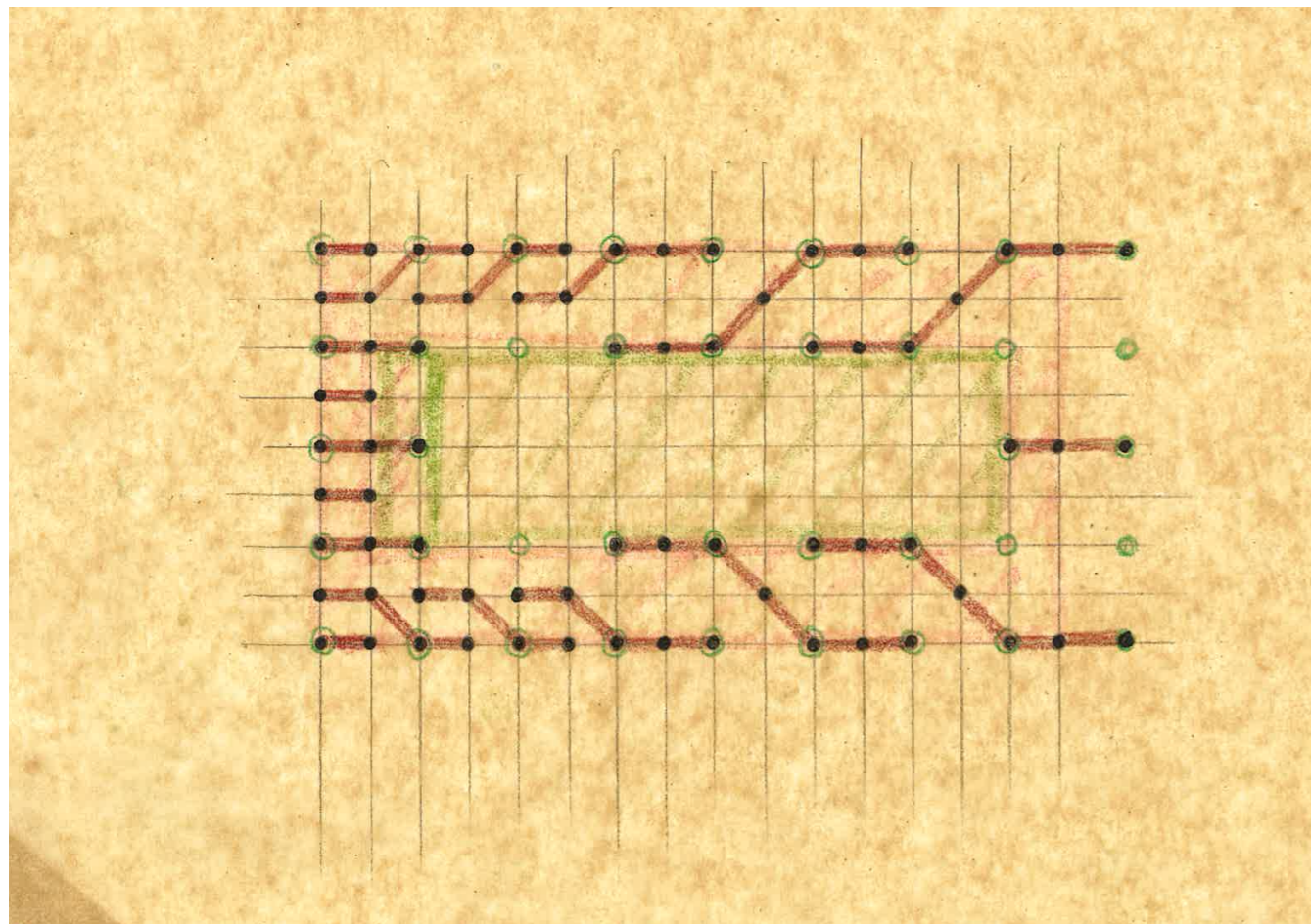
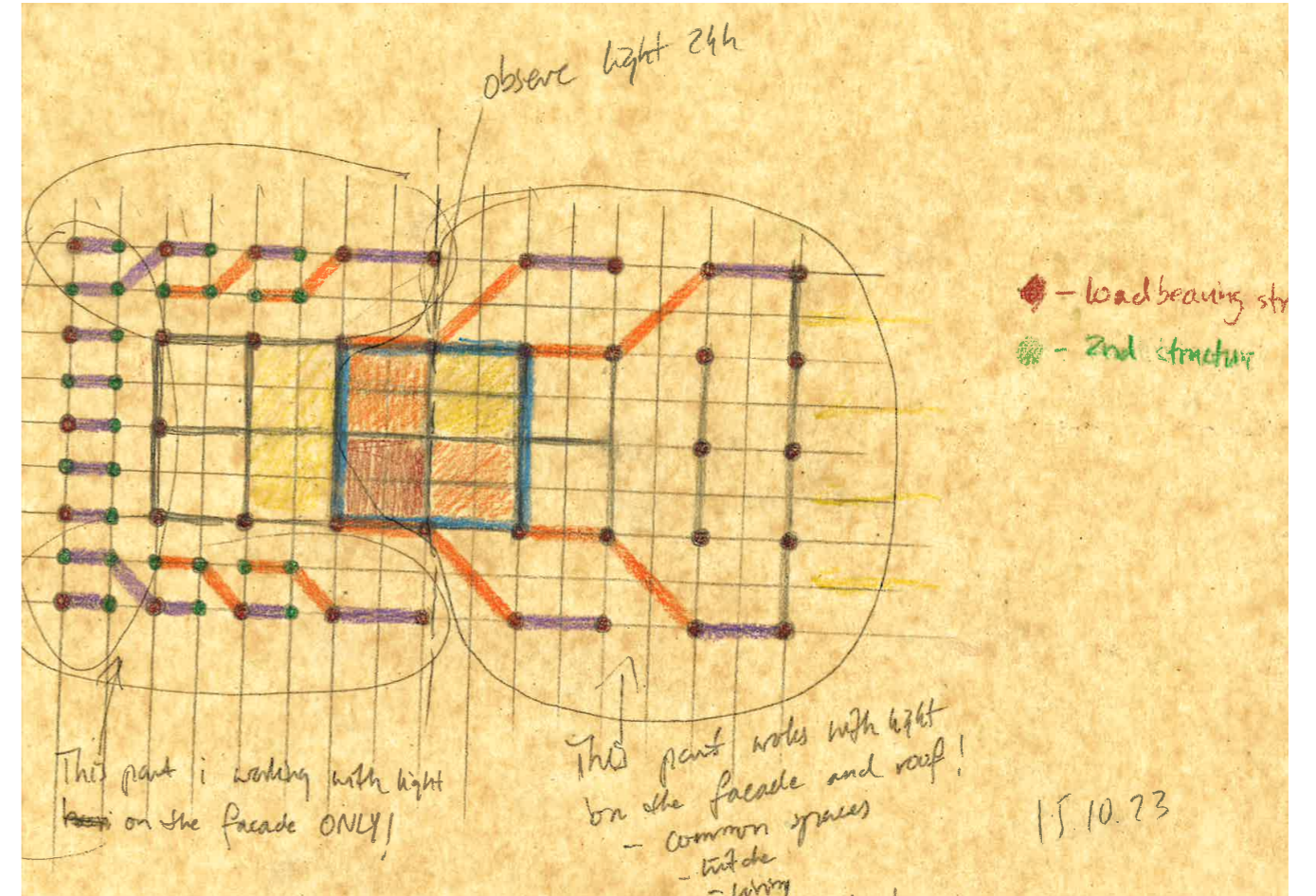
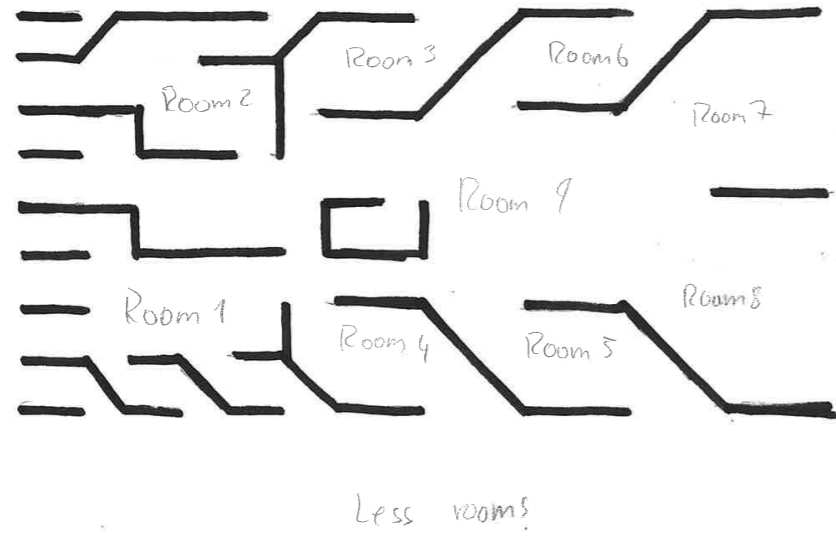

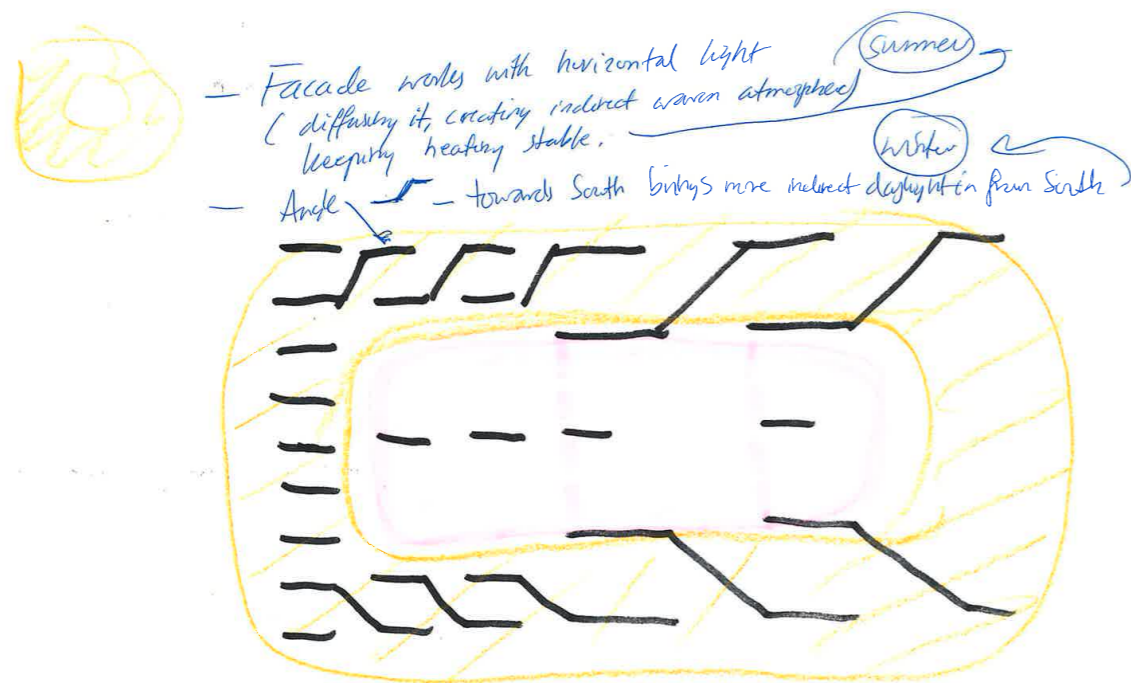
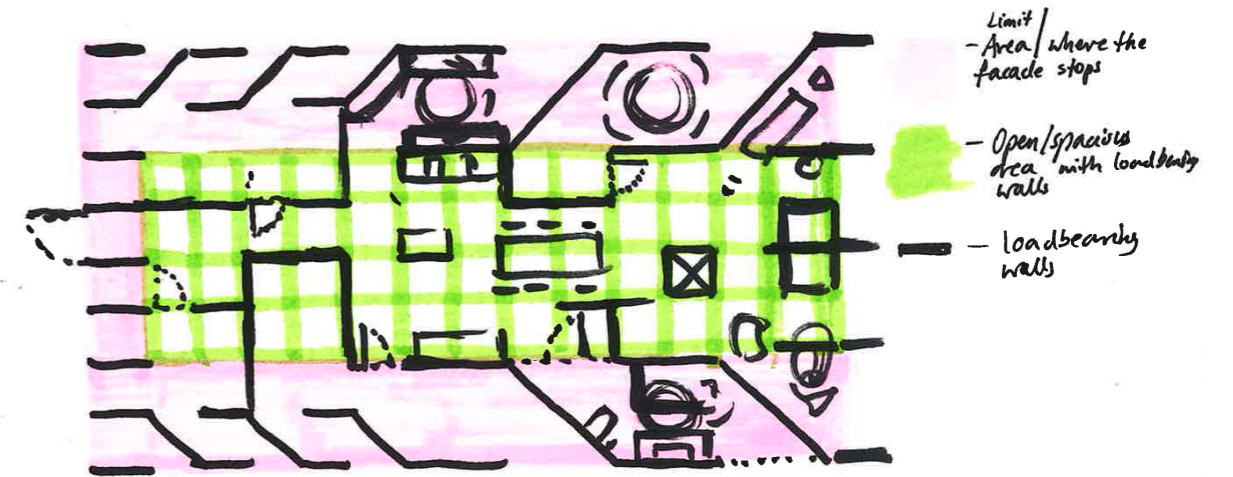
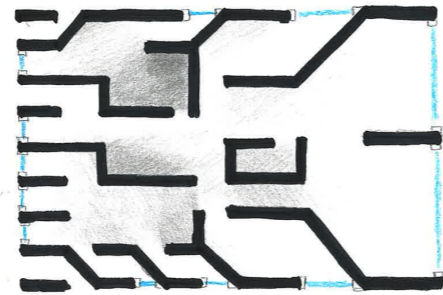
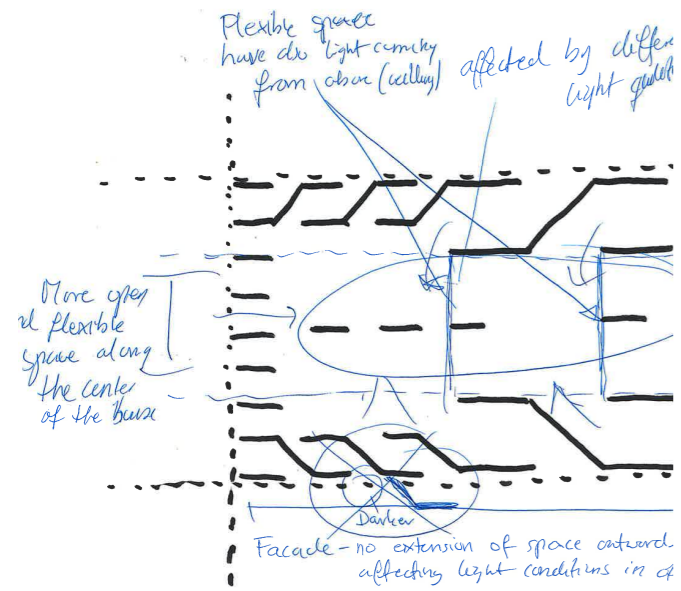

- works vertically with light
- catches the skylight. Different heights create openings that provide spaces with light from South (especially during winter)
- The project works vertically with light only in the center of the building (open spacious area, flexible area)

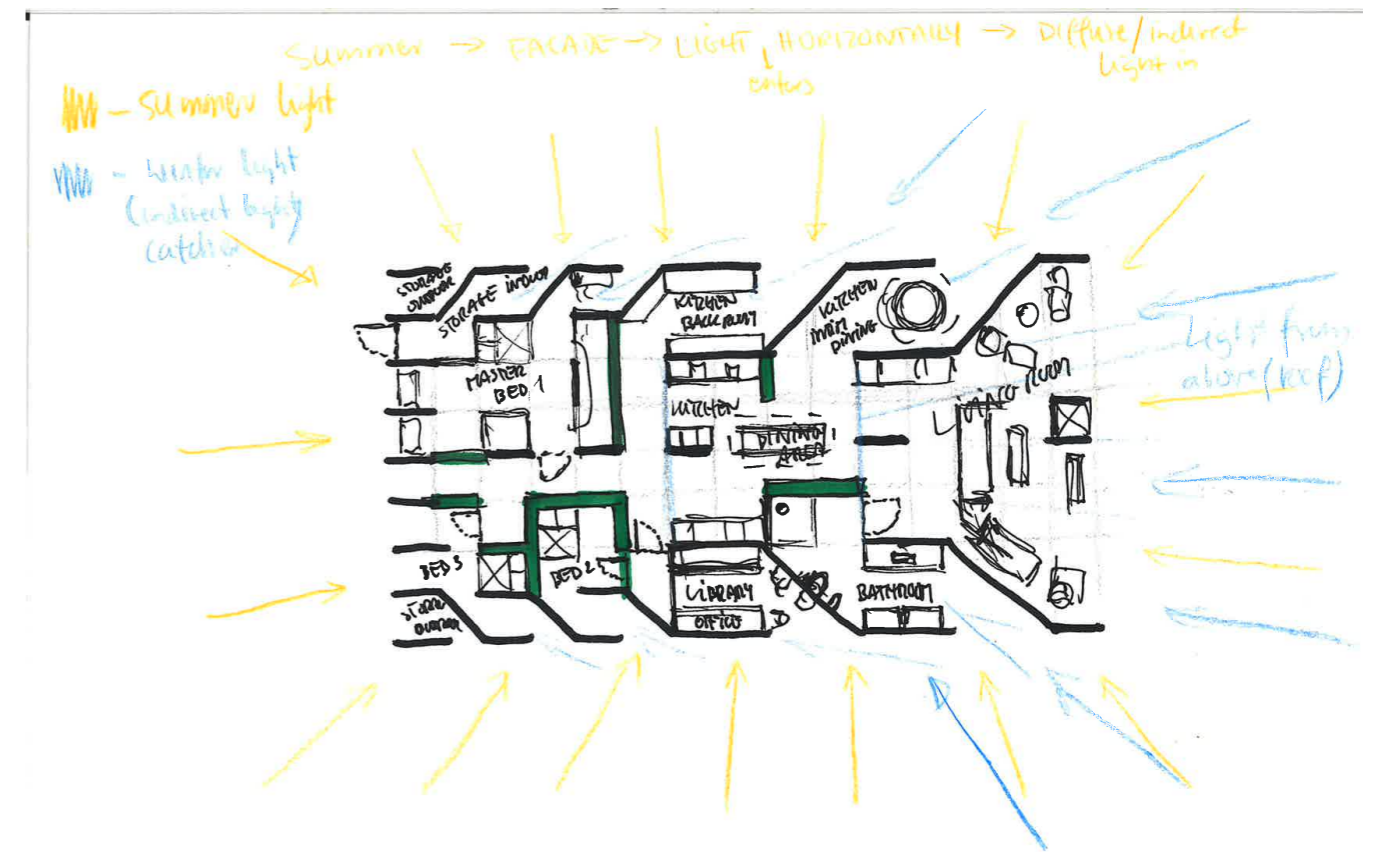

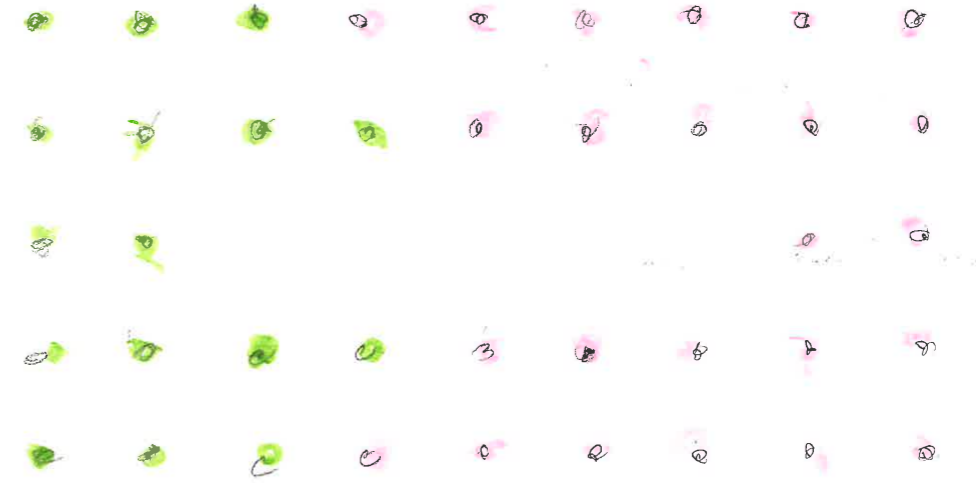
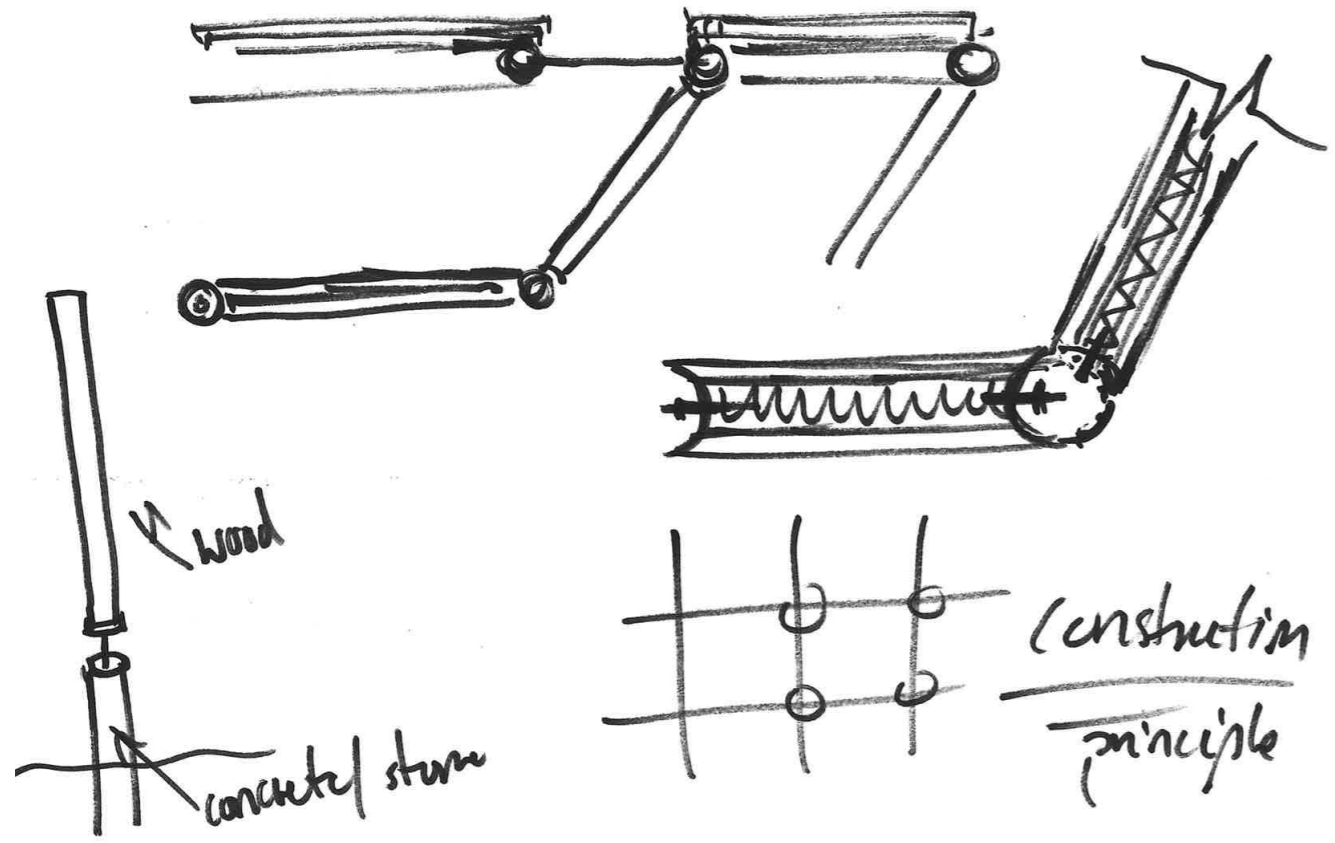

Pillars - loadbearing
 Beams - Roof
 Pillars
 Pillars - floor

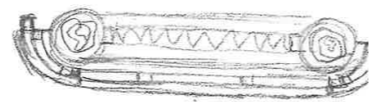
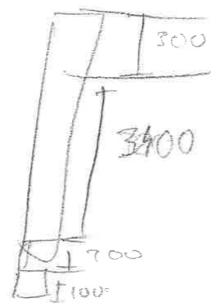
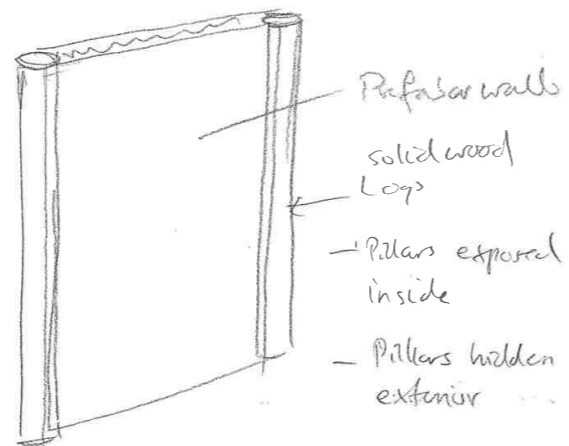

3700

2900

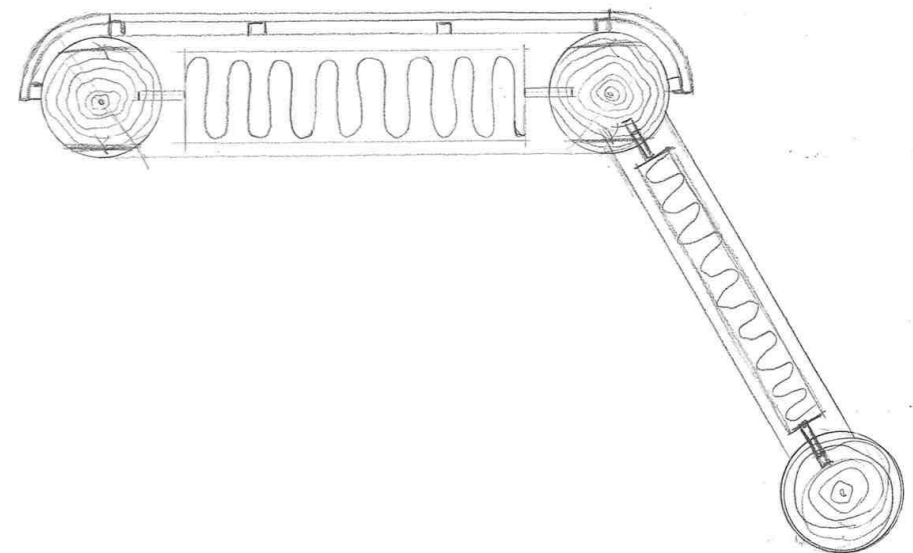

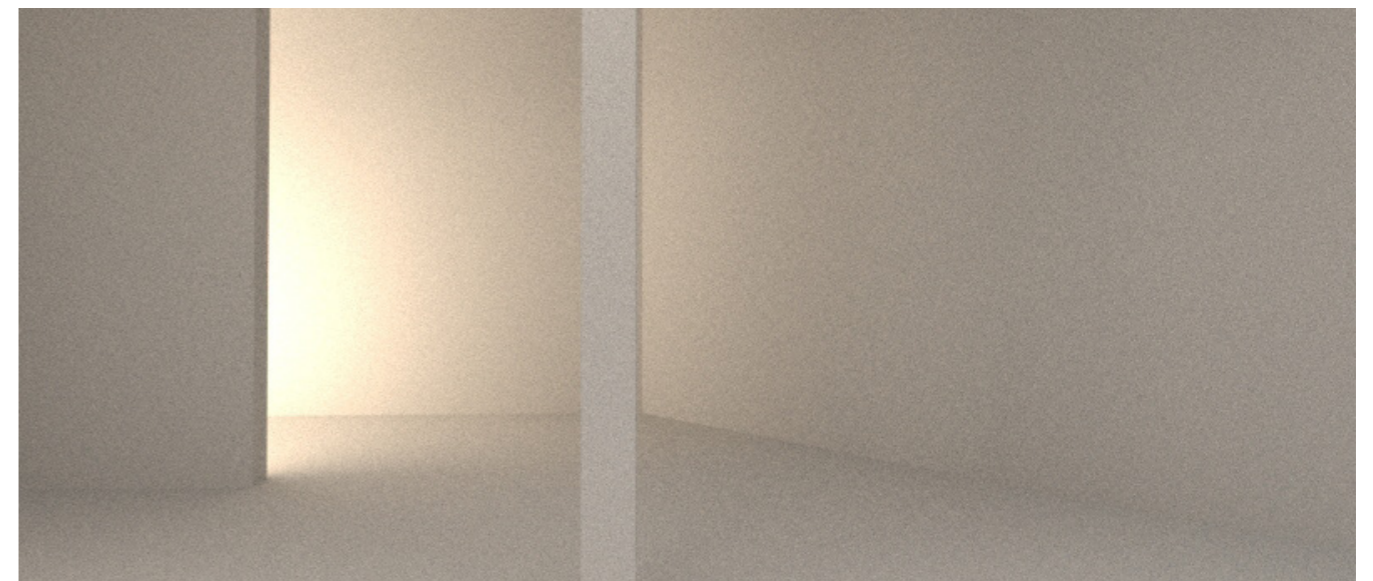
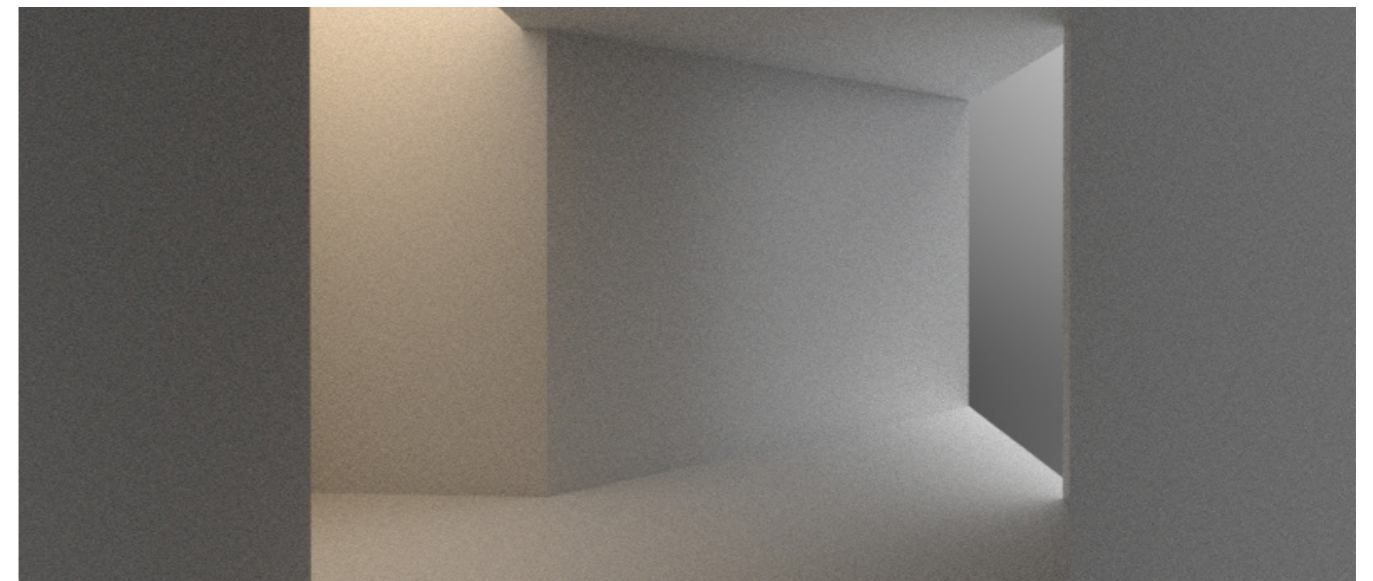
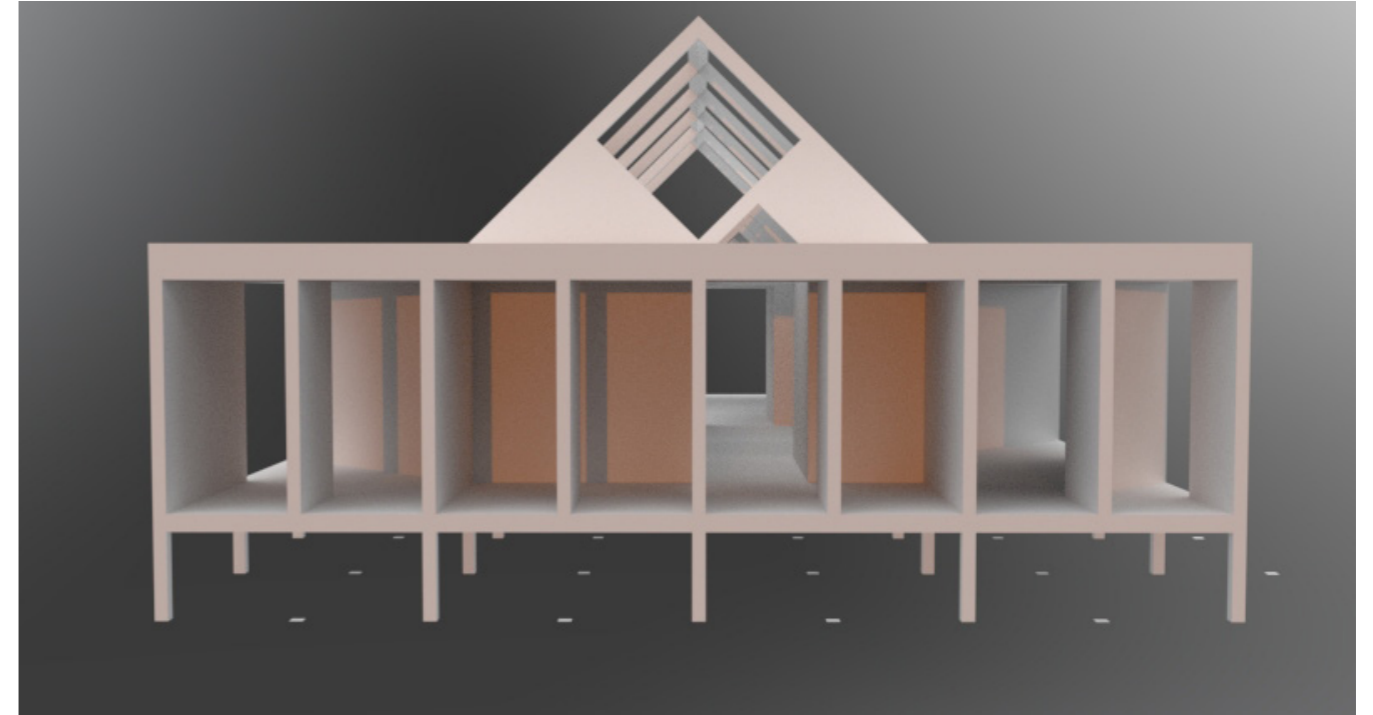
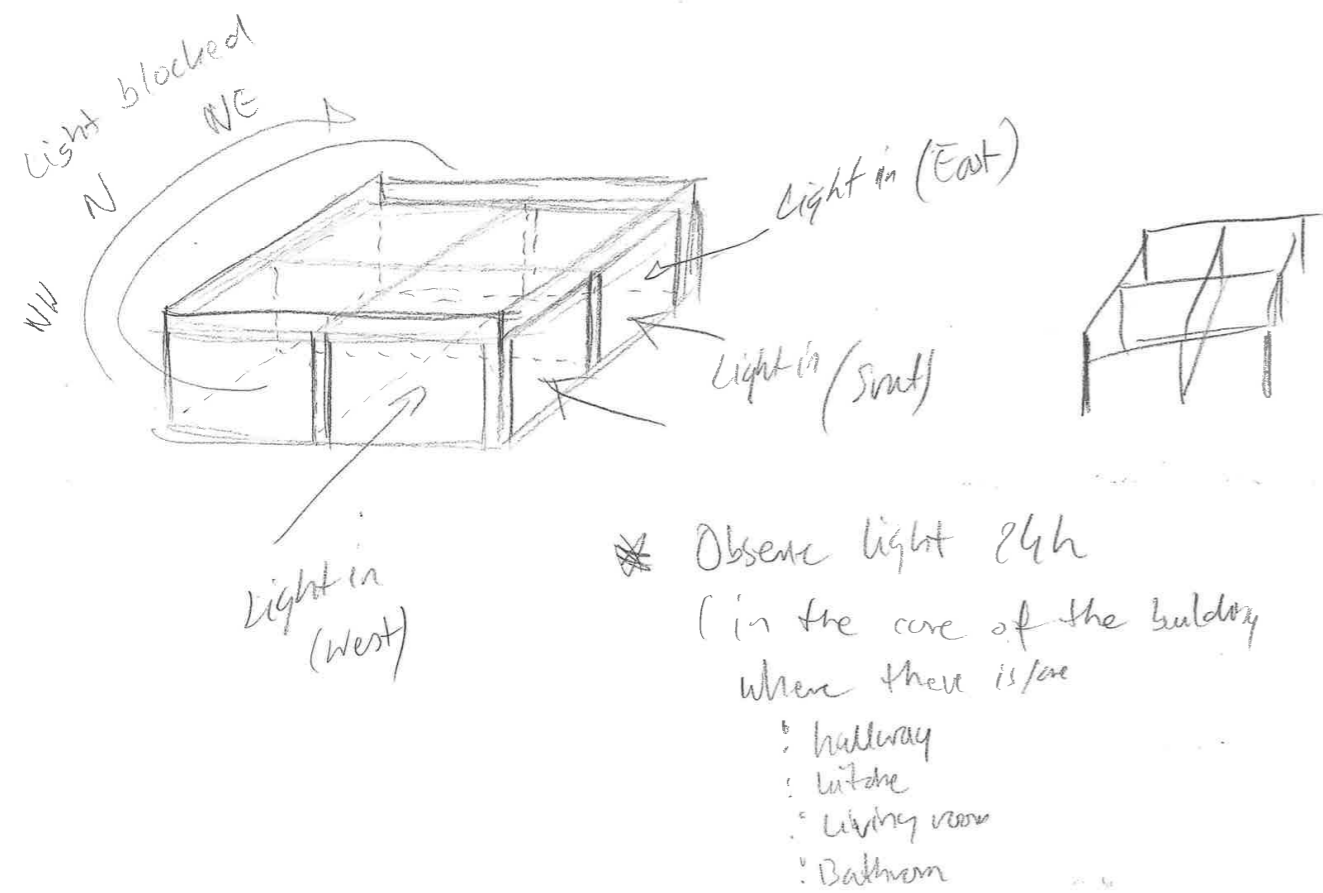
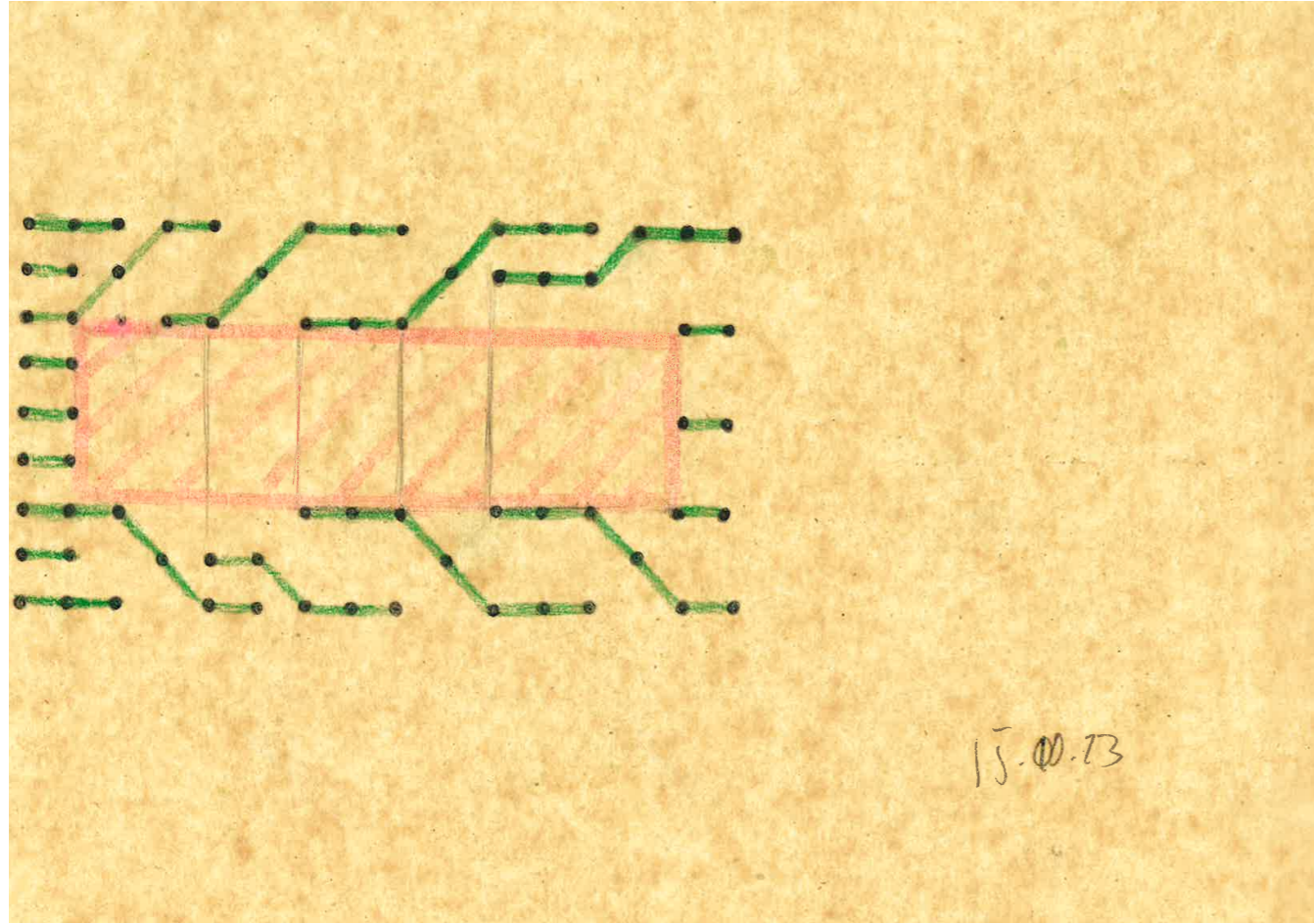

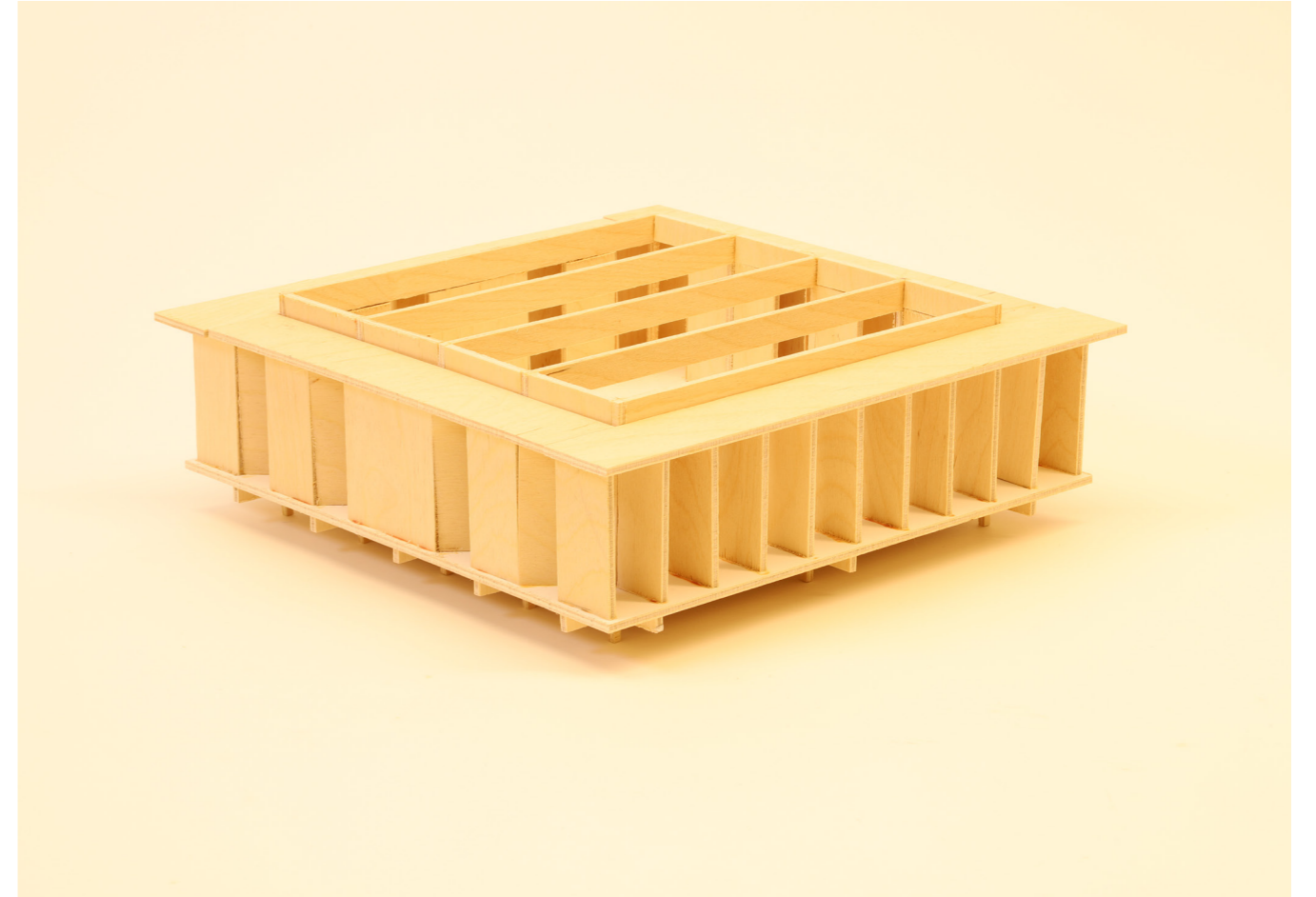
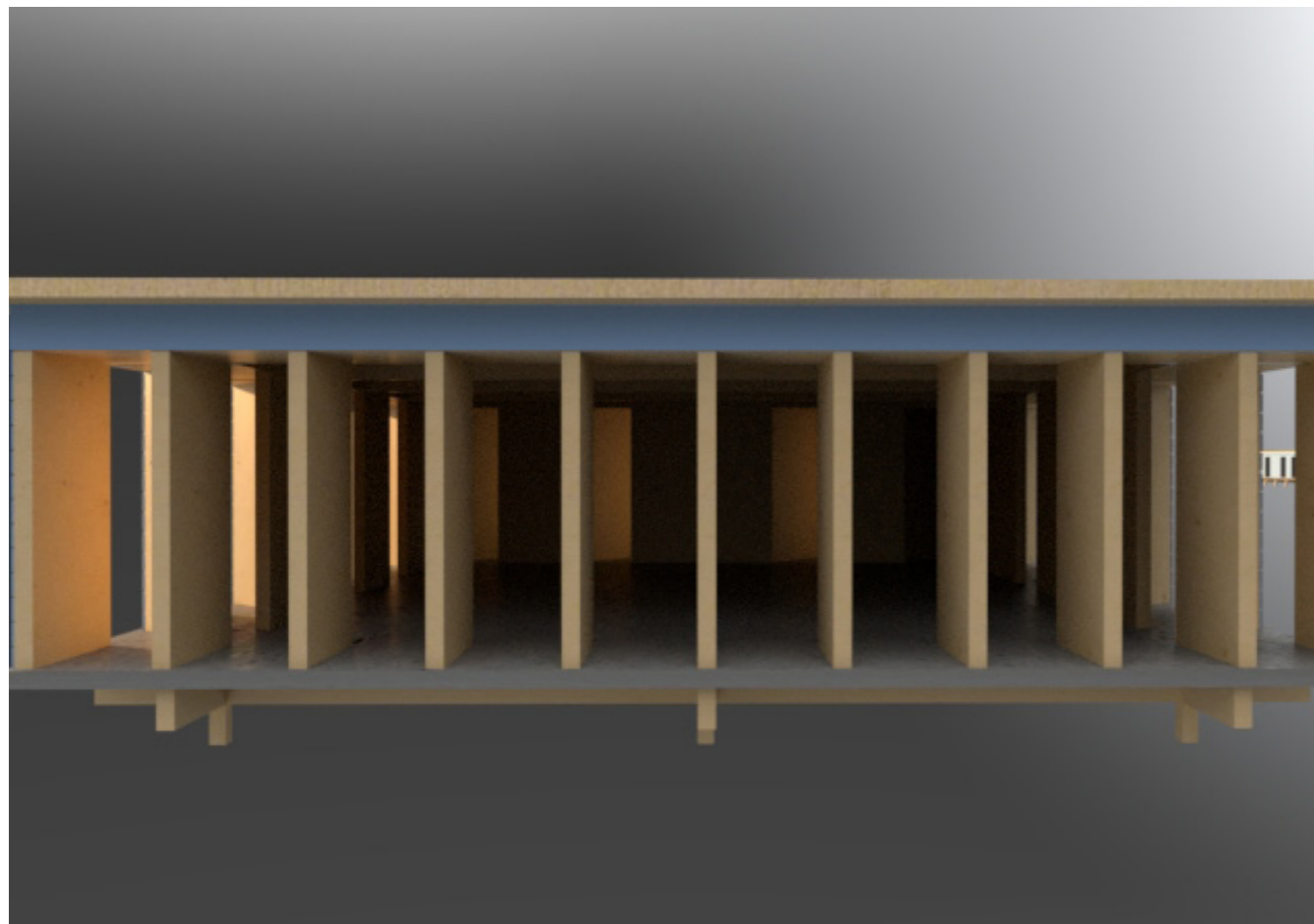
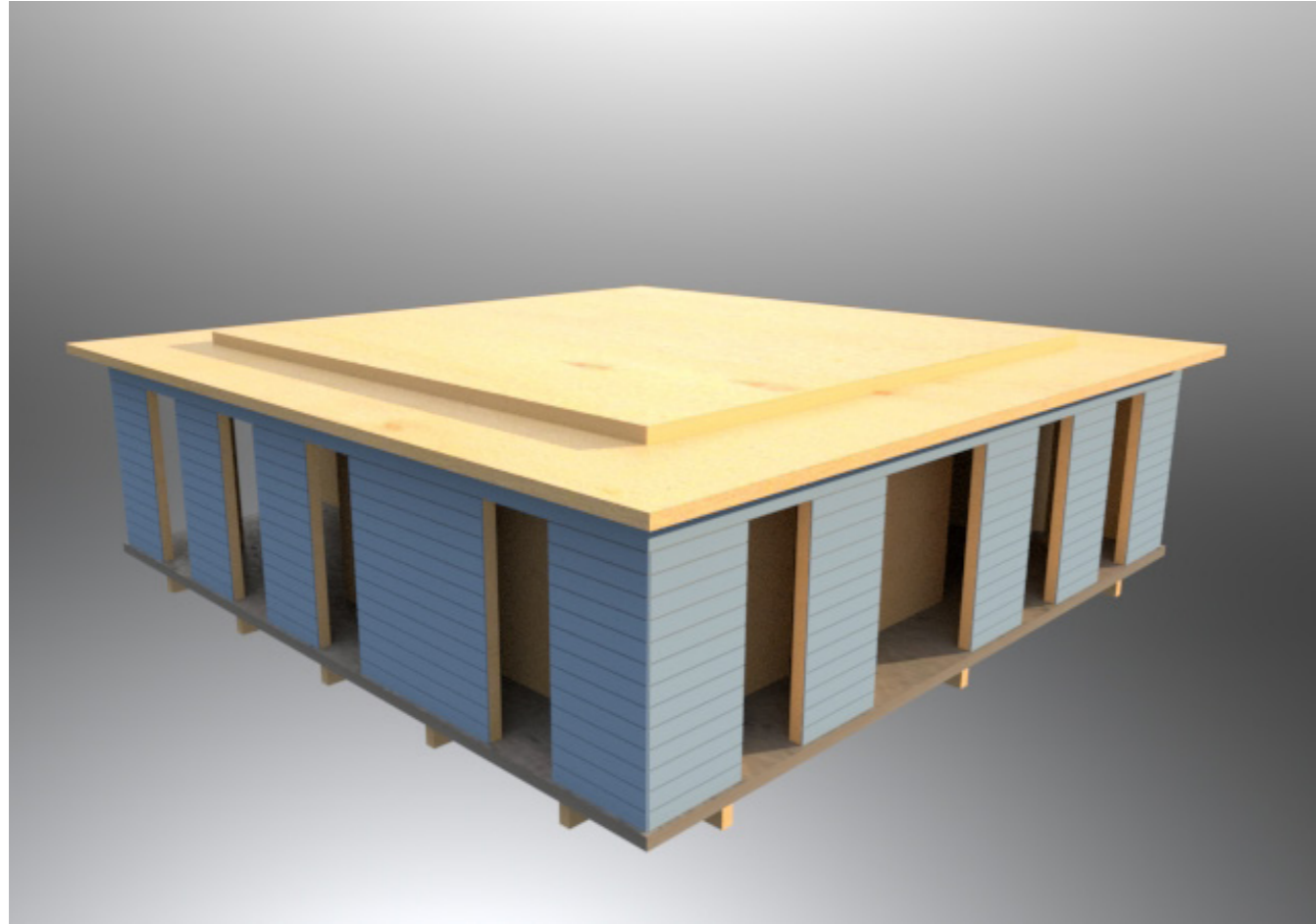

15.MARCH (HELIODON)

15.JUNE (HELIODON)



00:00 am (HELIODON)



04:00 am (HELIODON)

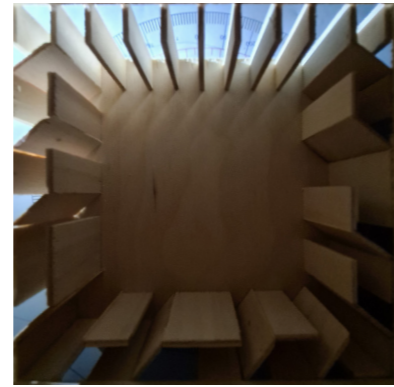

08:00 am (HELIODON)



00:00 am (HELIODON)



04:00 am (HELIODON)

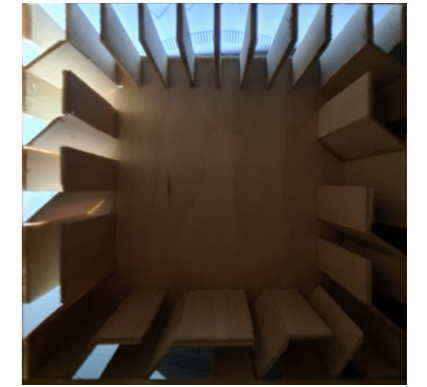

08:00 am (HELIODON)

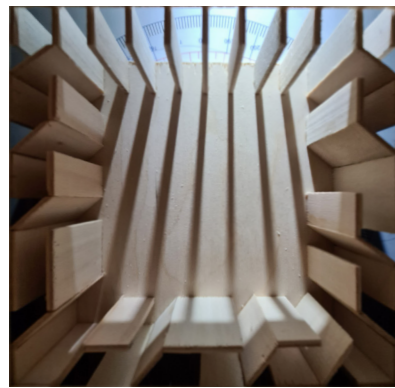

12:00 pm (HELIODON)

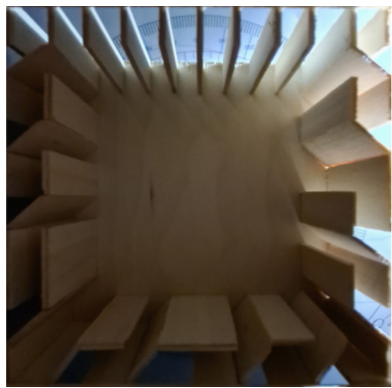

16:00 pm (HELIODON)



20:00 pm (HELIODON)

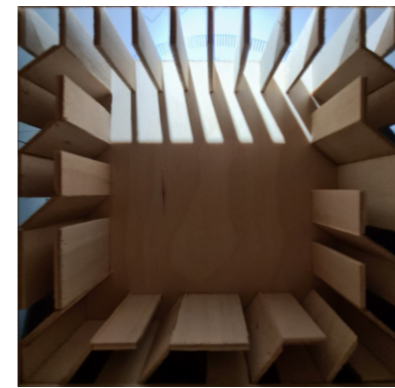

12:00 pm (HELIODON)



16:00 pm (HELIODON)



20:00 pm (HELIODON)

15. SEPTEMBER (HELIODON)

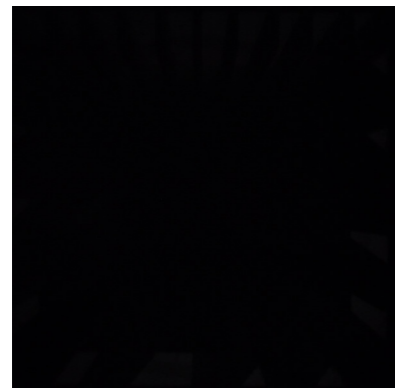

00:00 am (HELIODON)

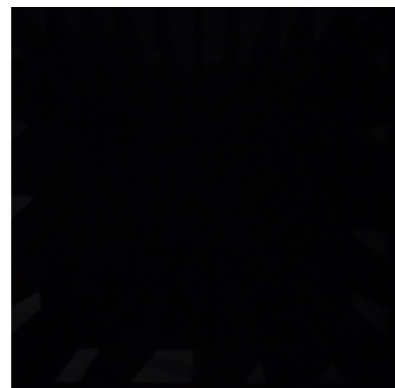

04:00 am (HELIODON)

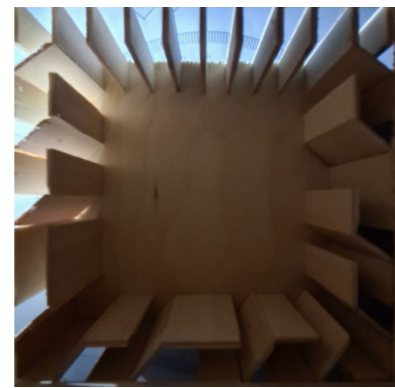

08:00 am (HELIODON)

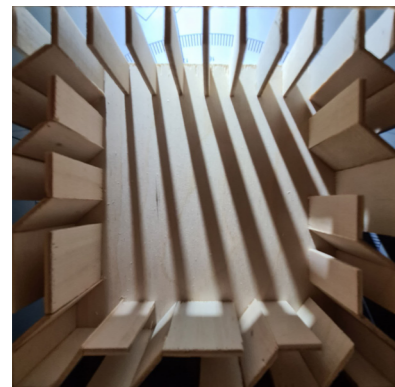

12:00 pm (HELIODON)

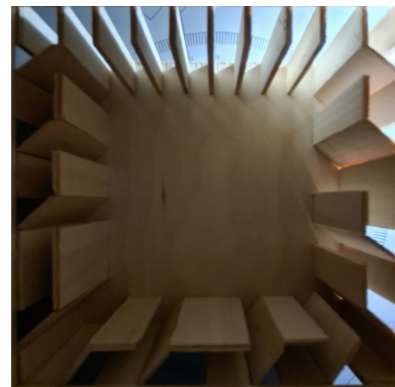

16:00 pm (HELIODON)



20:00 pm (HELIODON)

15. DECEMBER (HELIODON)

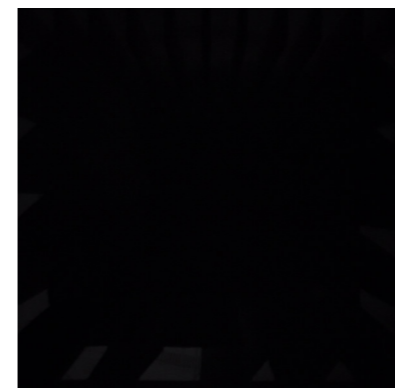

00:00 am (HELIODON)



04:00 am (HELIODON)



08:00 am (HELIODON)



12:00 pm (HELIODON)



16:00 pm (HELIODON)

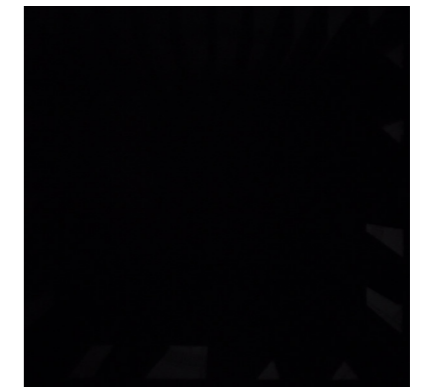

20:00 pm (HELIODON)

CONSTRUCTION

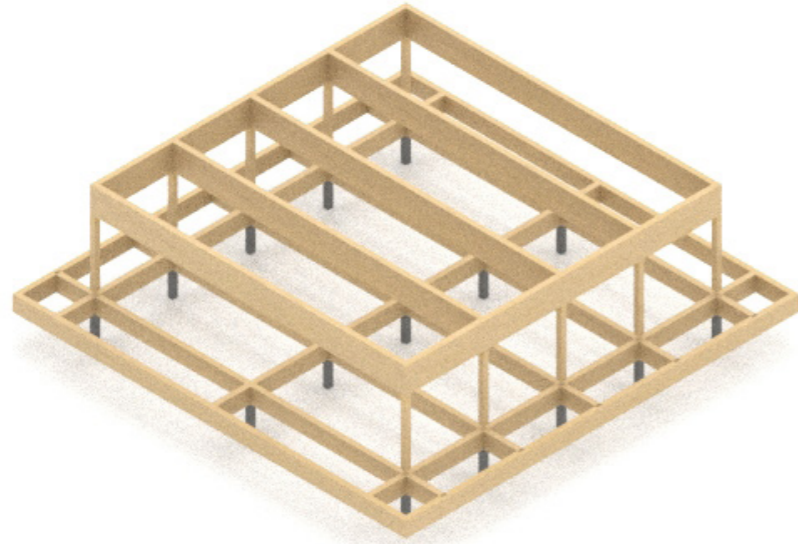

GLULAM BEAM 200x1000
GLULAM PILLAR 200x200 H-2520
CONCRETE FOUNDATION
200x200 1000mm above the ground

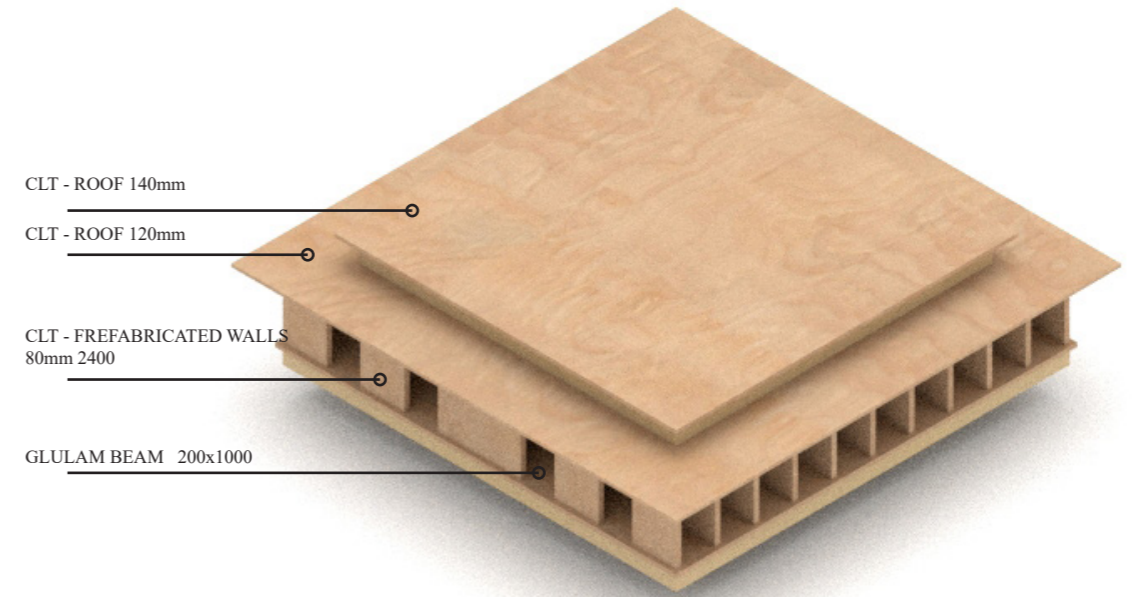
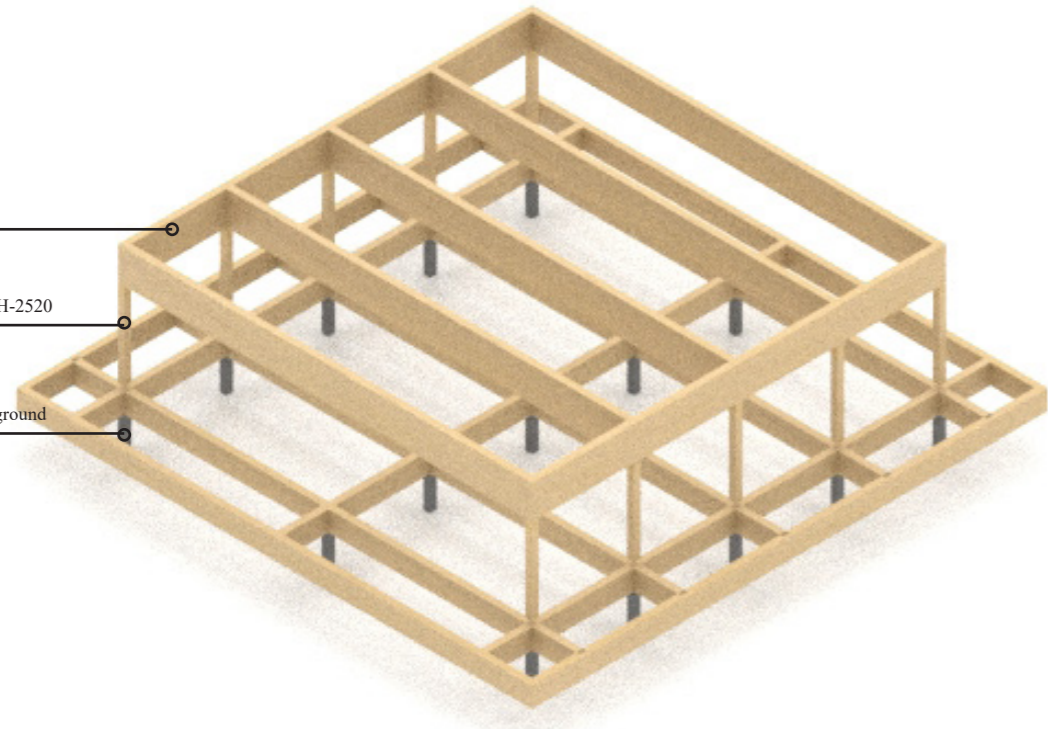

CLT - ROOF 140mm
CLT - ROOF 120mm
CLT - PREFABRICATED WALLS
80mm 2400
GLULAM BEAM 200x1000

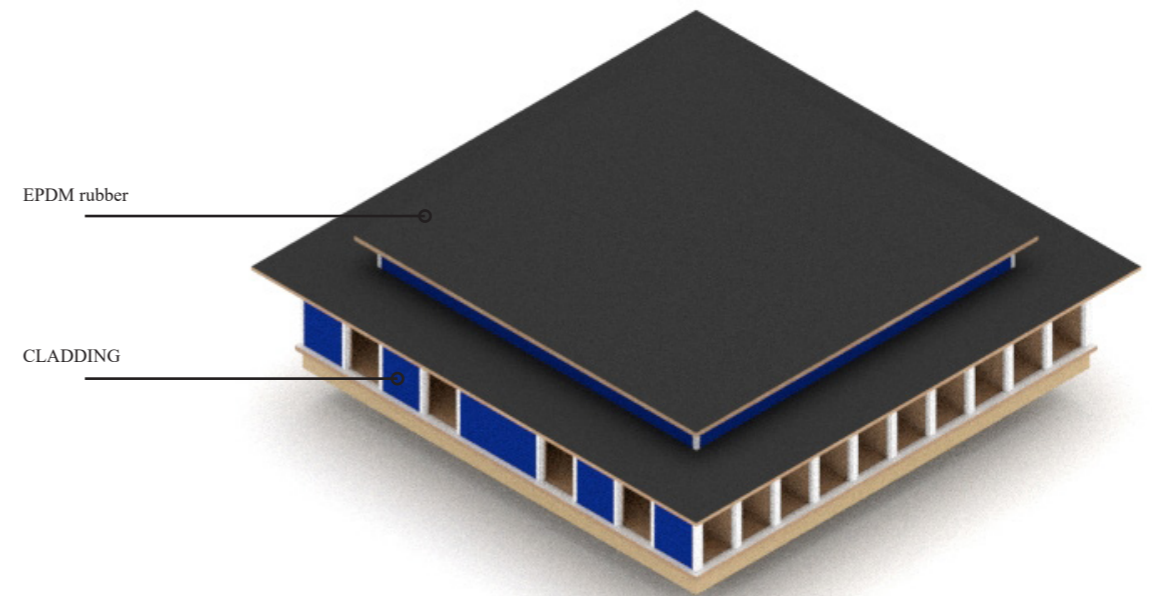

EPDM rubber
CLADDING

Southern wall - Winter - first sunrise after dark-period

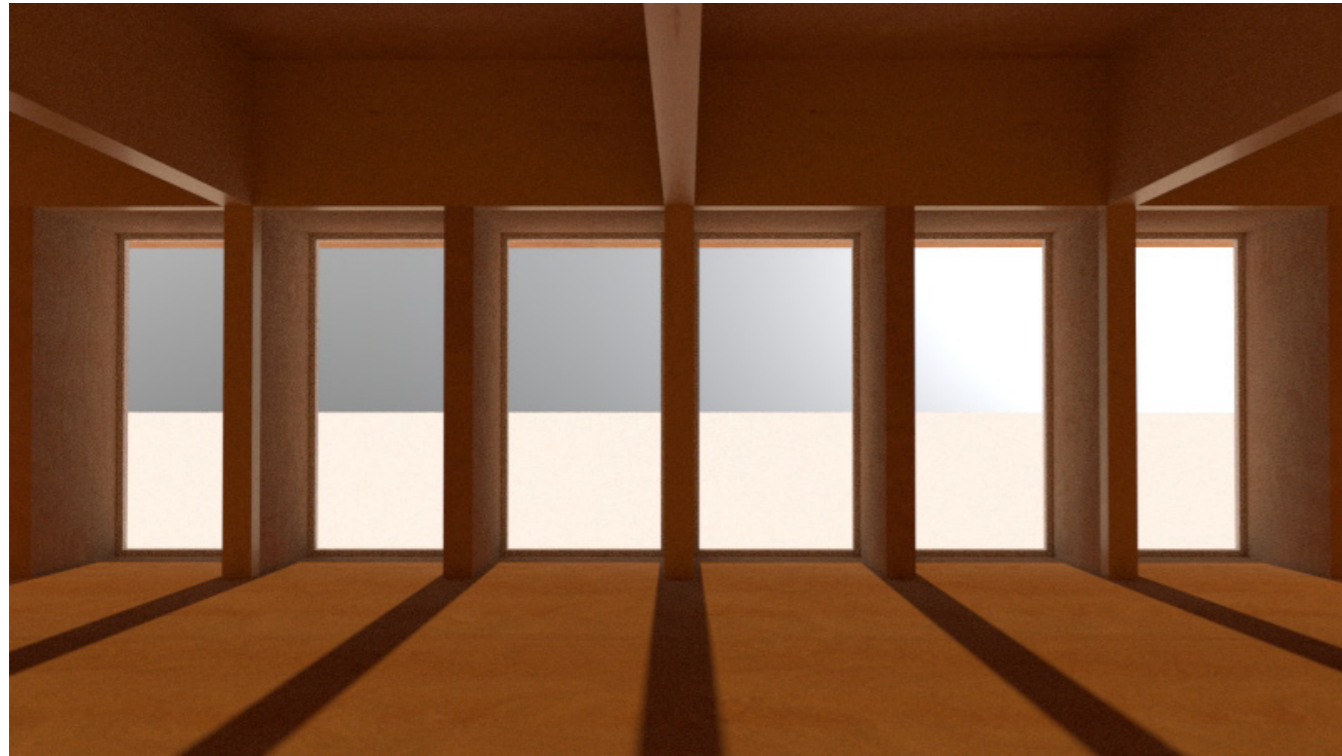

Western&Northern walls - Winter - first sunrise after dark-period



Eastern wall - Summer - morning light

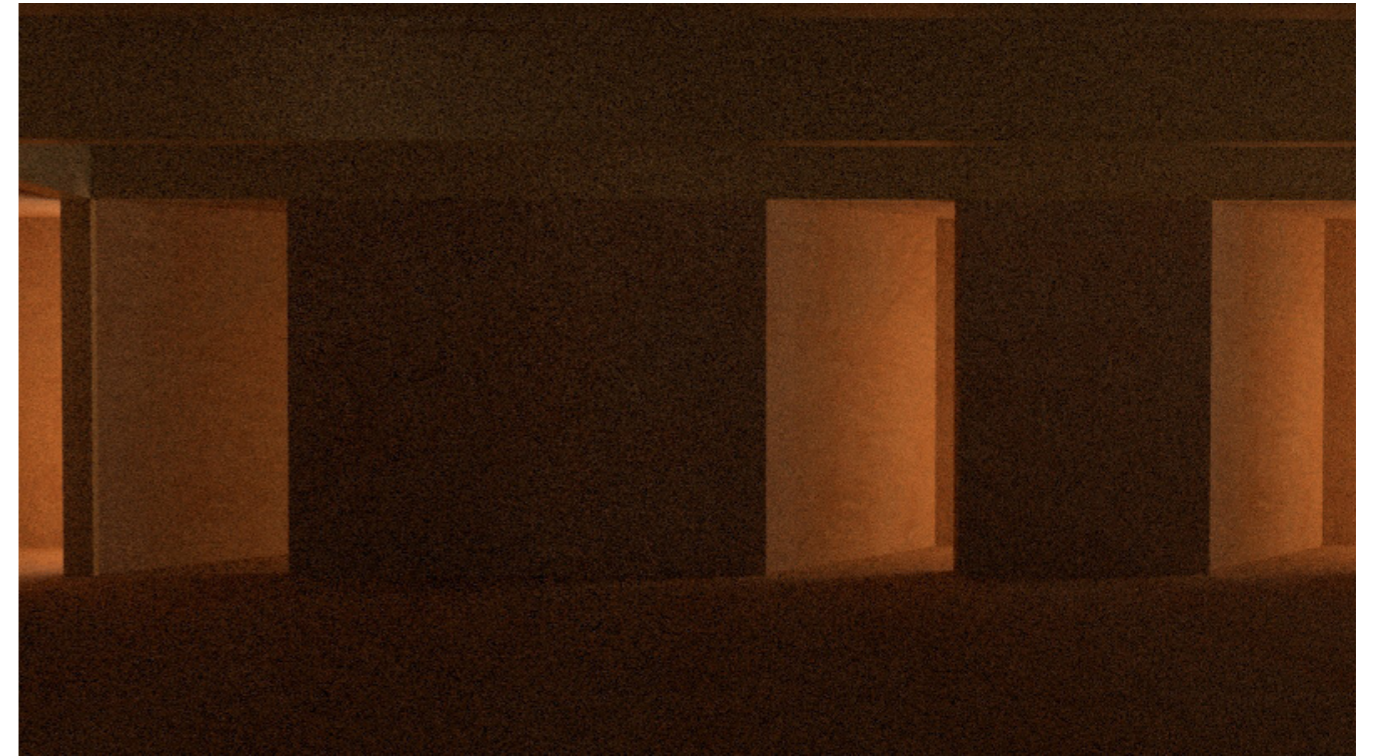

Western wall - Summer - evening light



Northern wall - Summer - midnightsun light

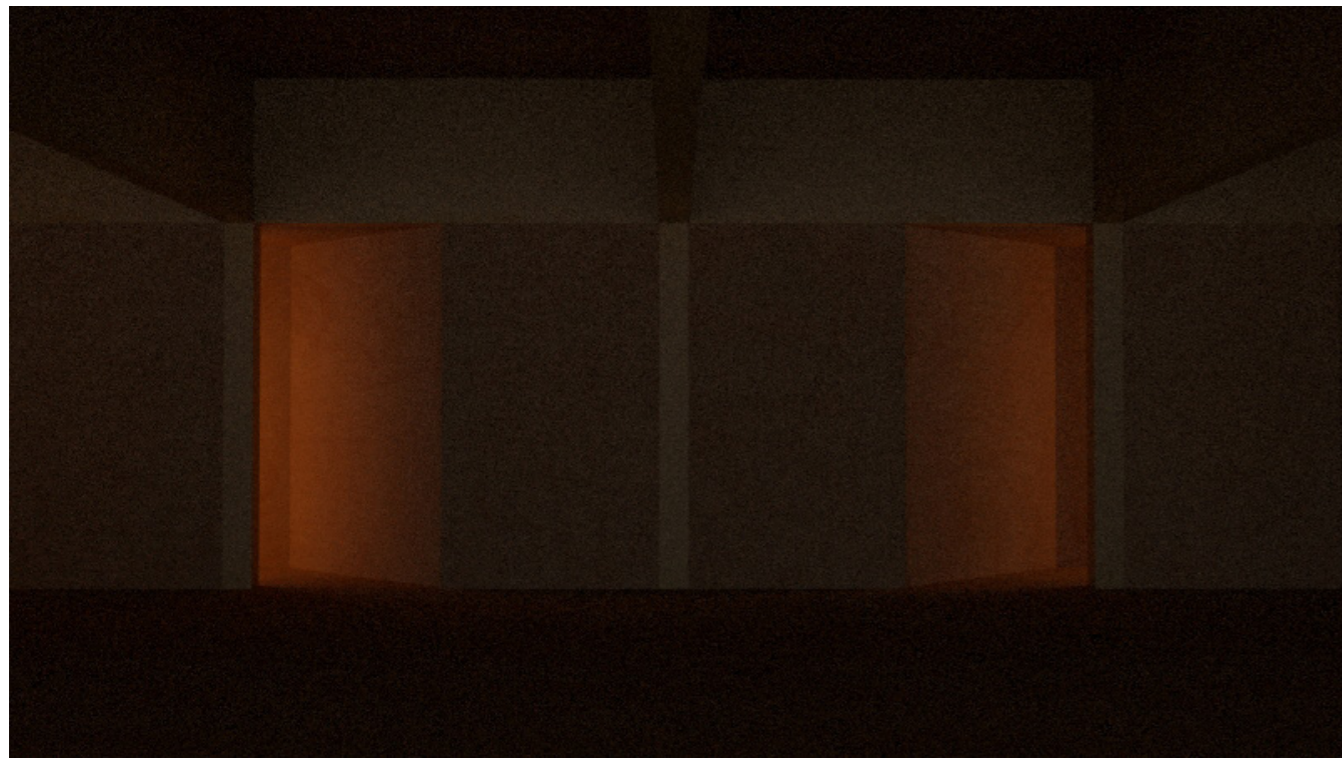

Southern wall - Winter - noon



SOUTH* - FACADE

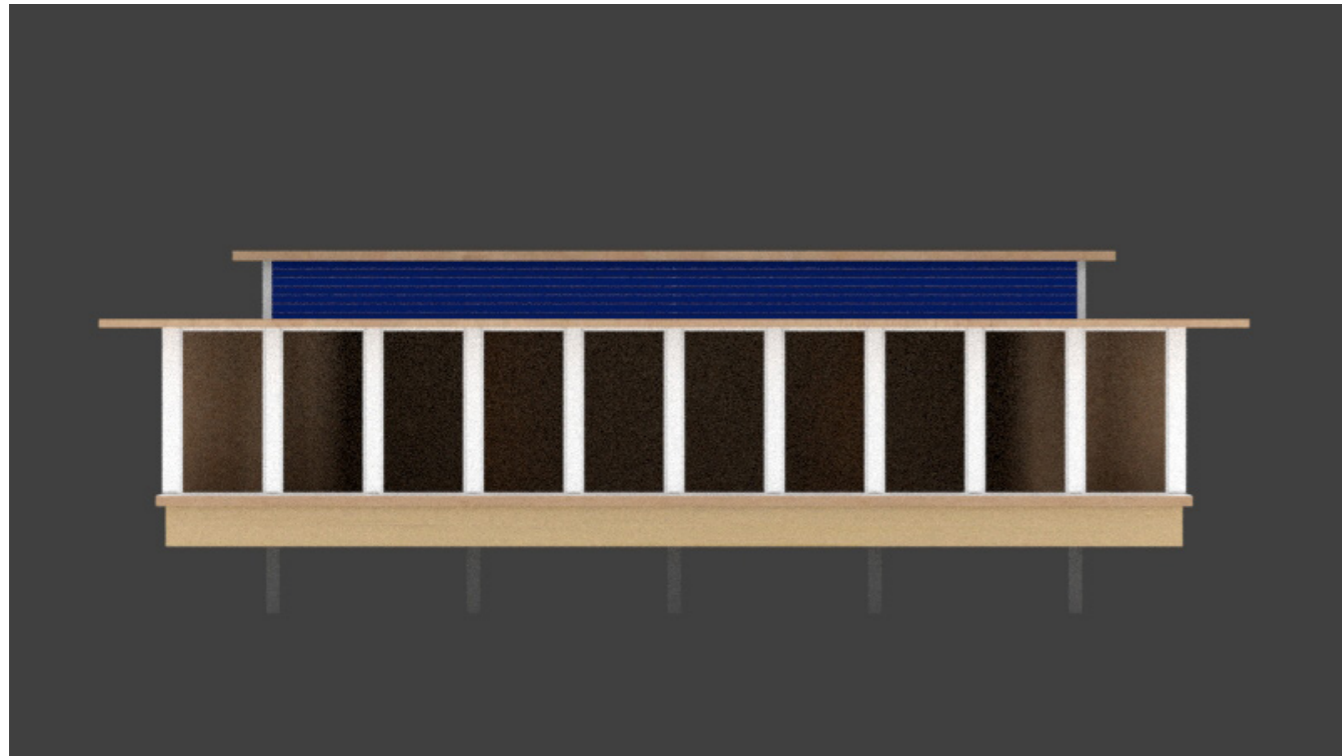

WEST* - FACADE

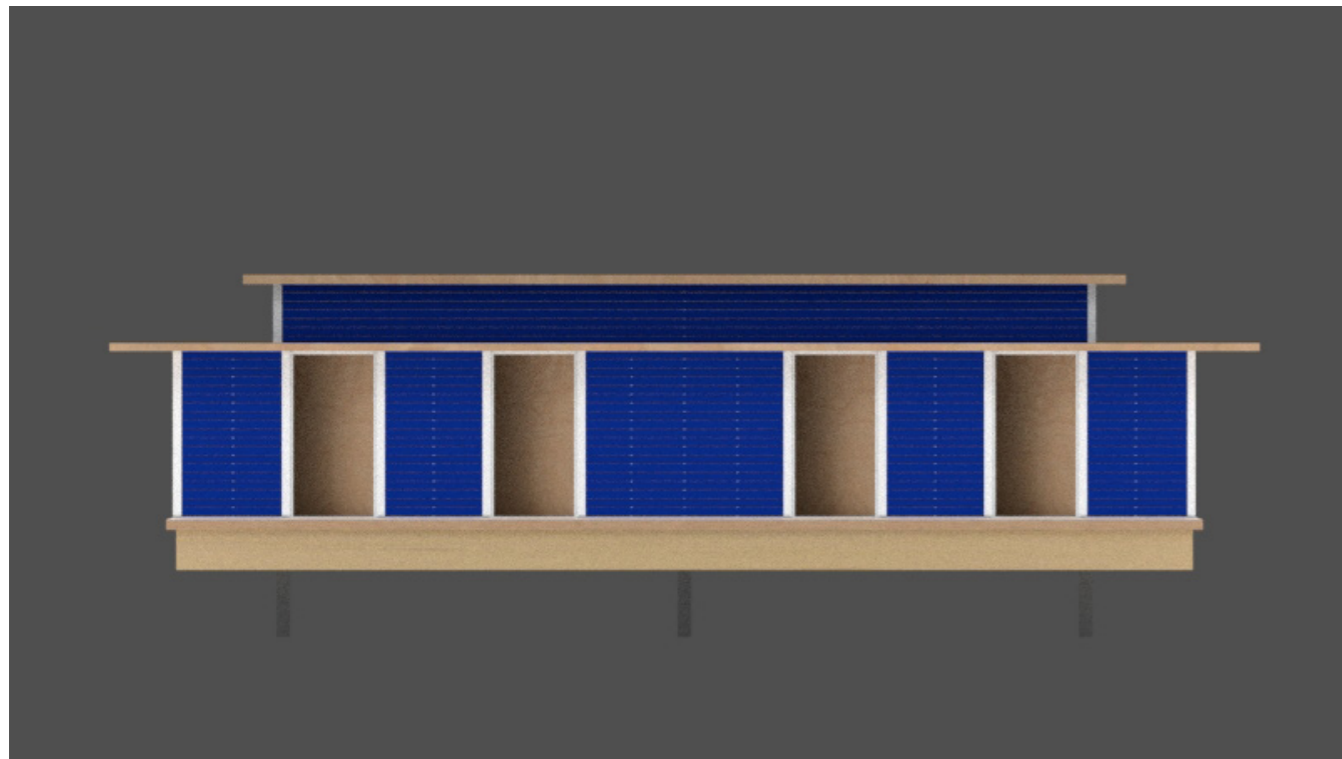

NORTH* - FACADE

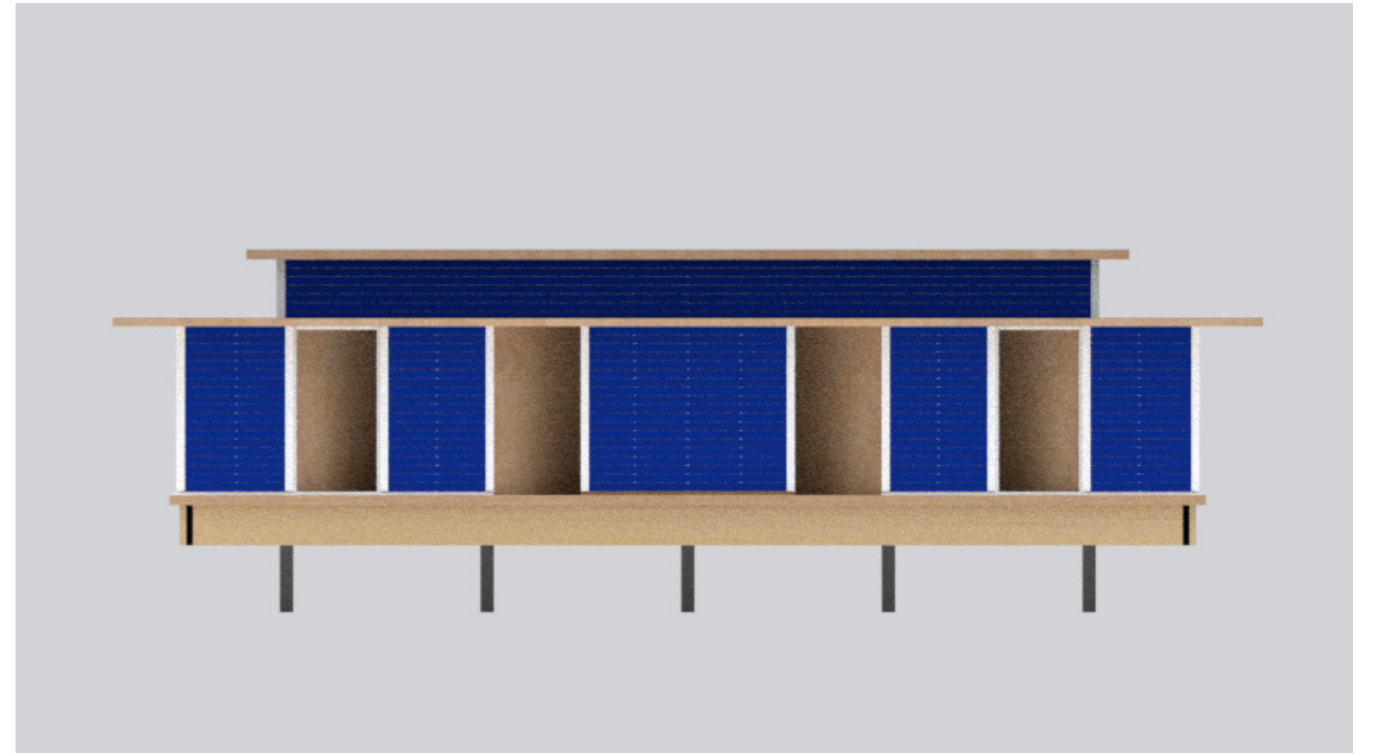

EAST* - FACADE

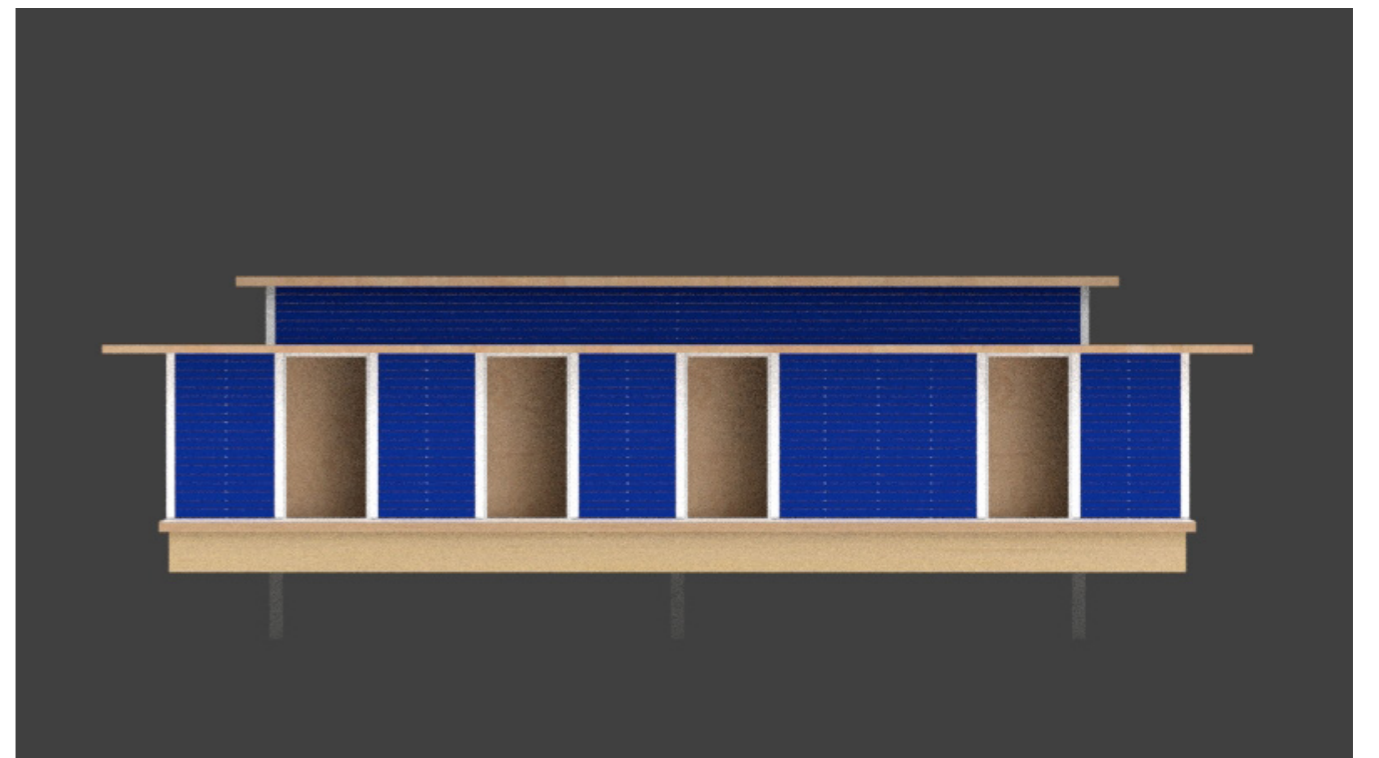

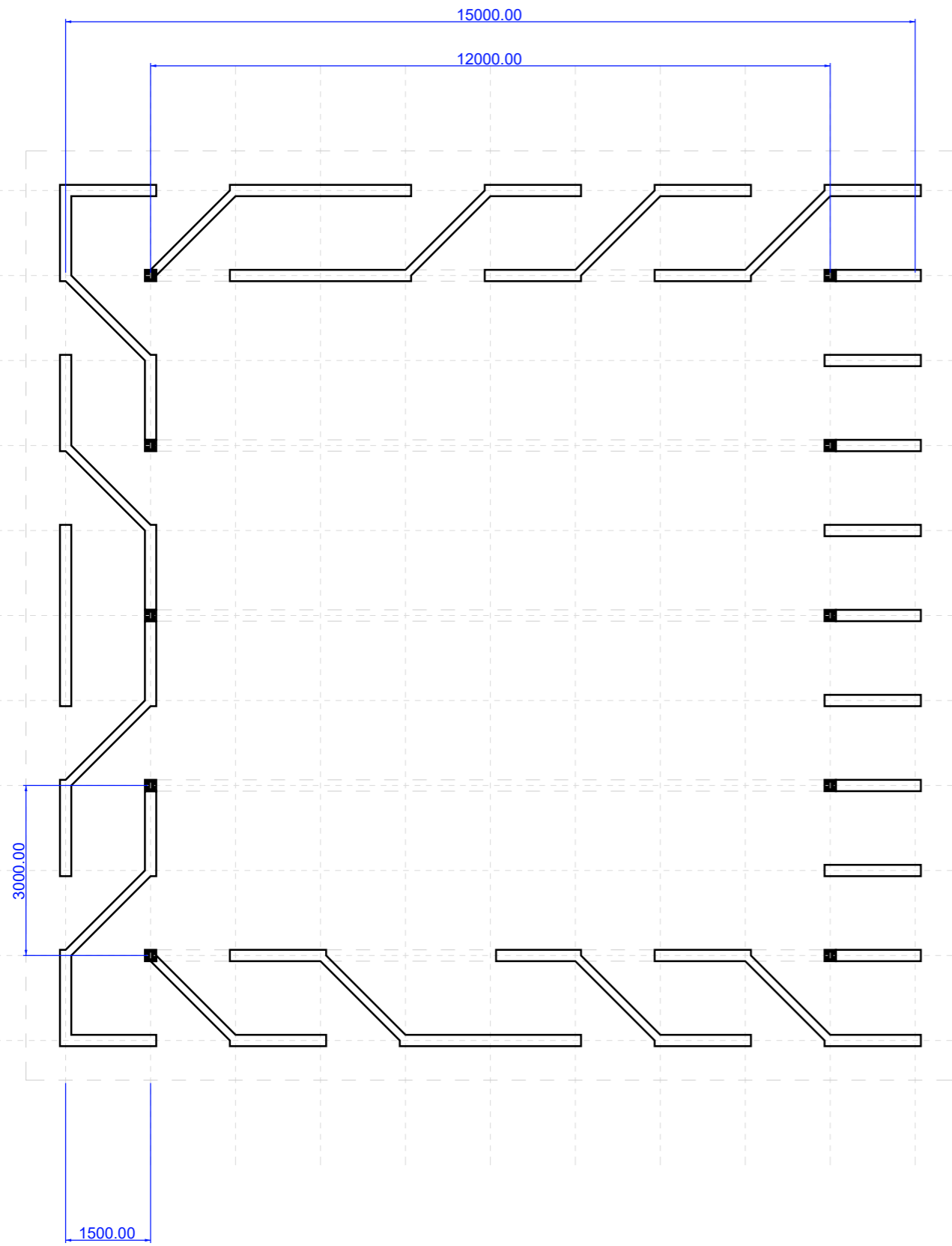

SCALE 1:100

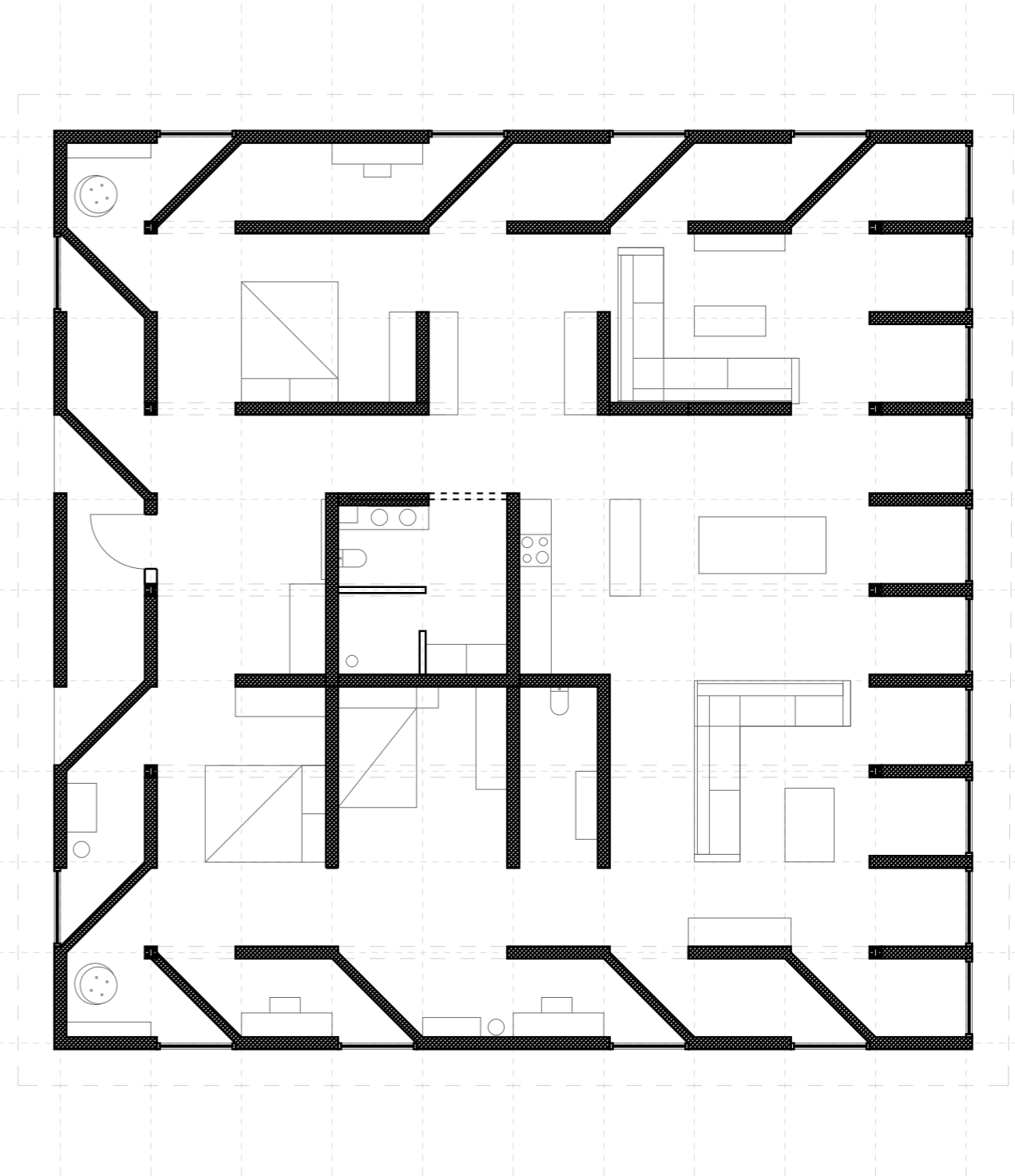

SCALE 1:100

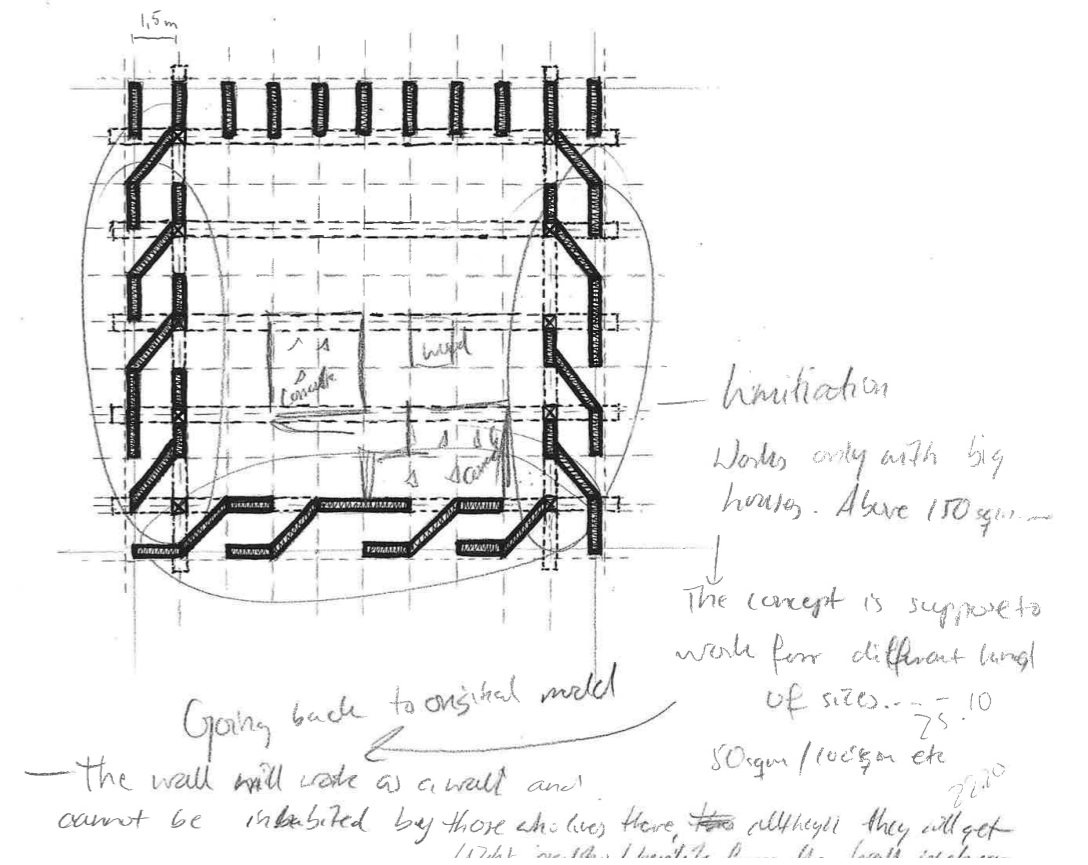
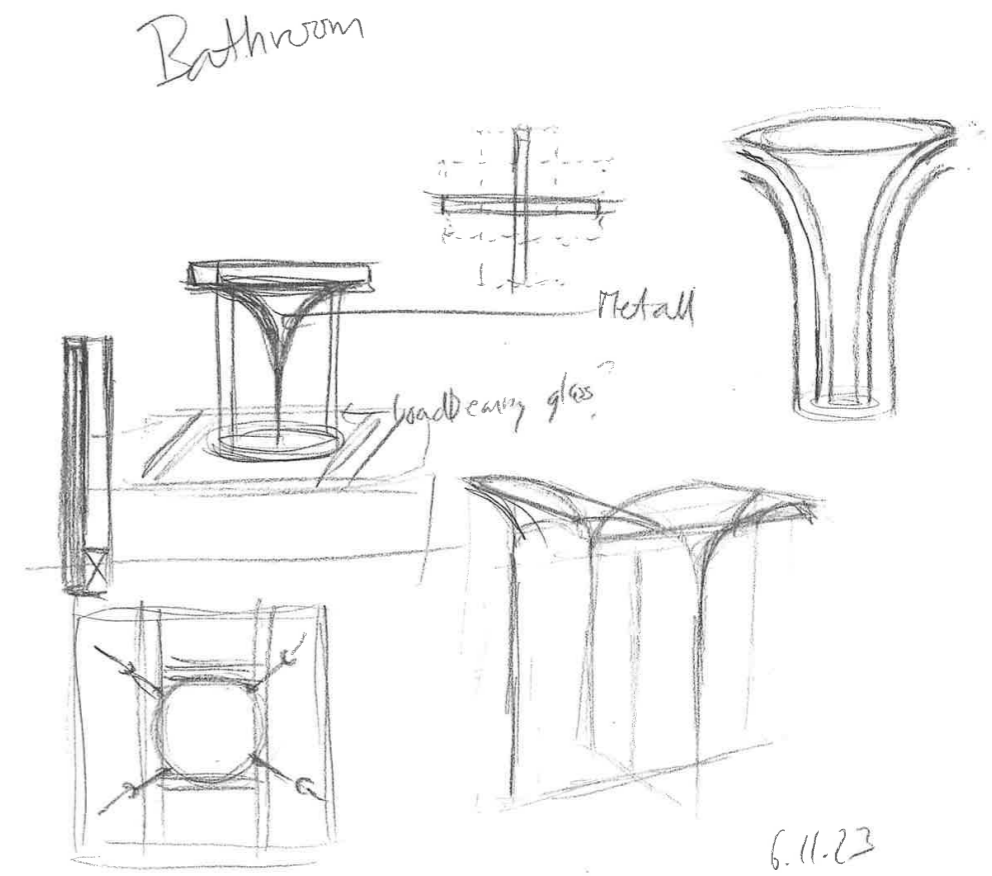
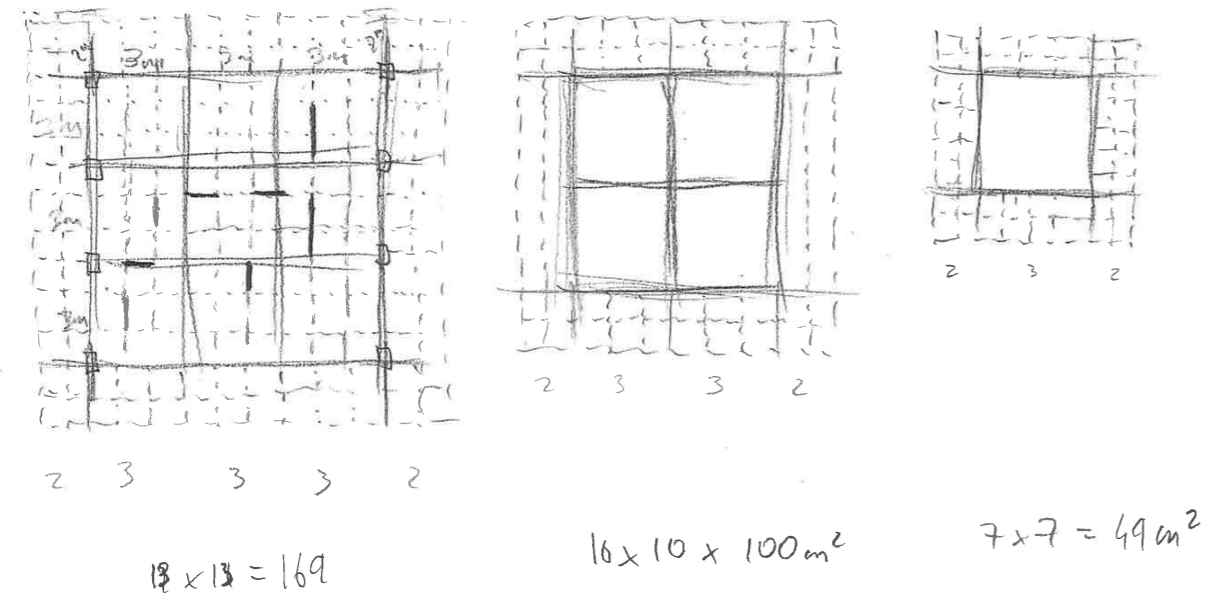
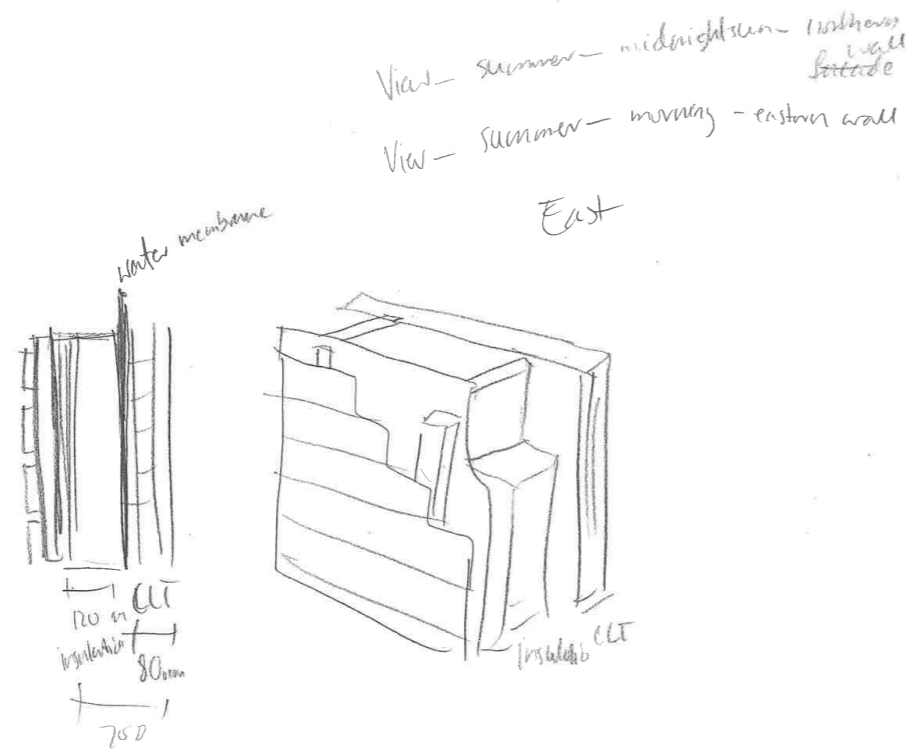

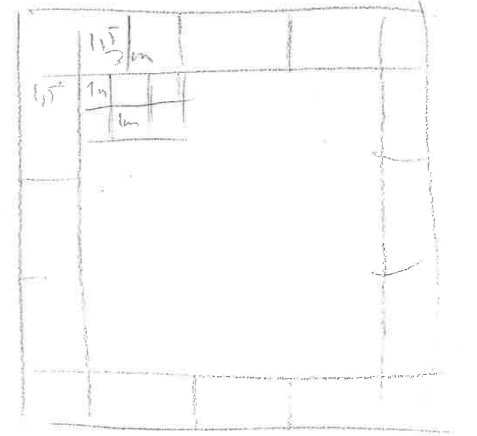
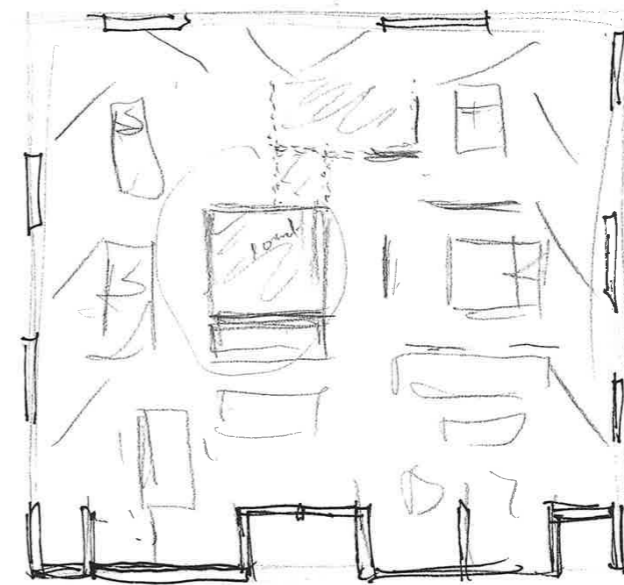
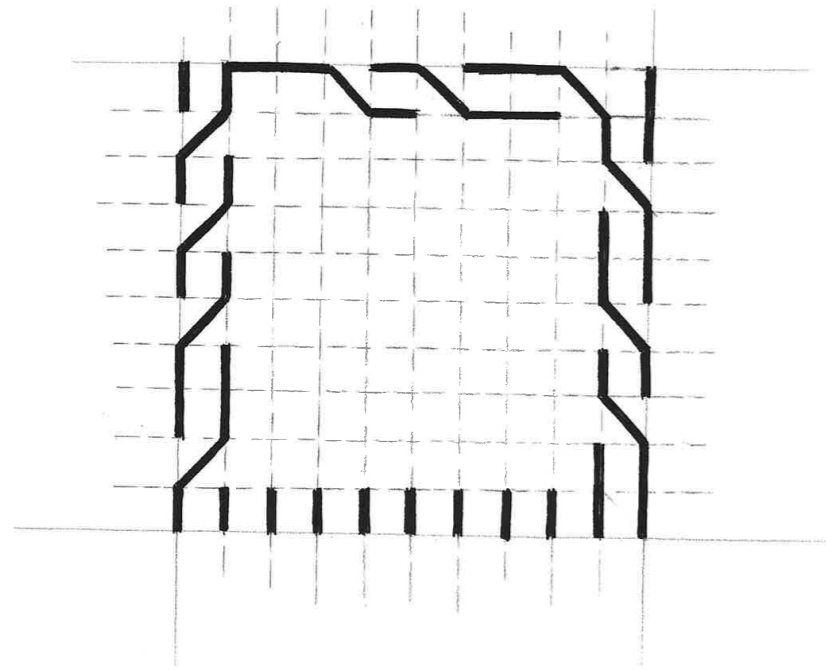

8.11.23

25.10

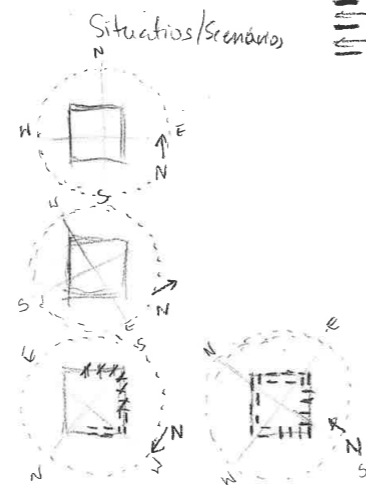
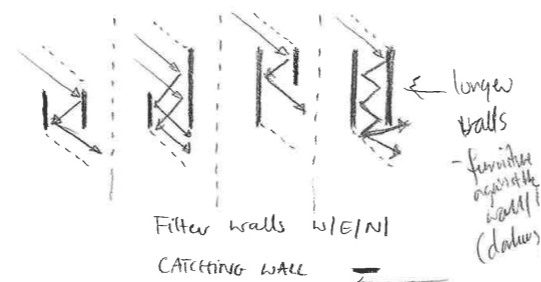
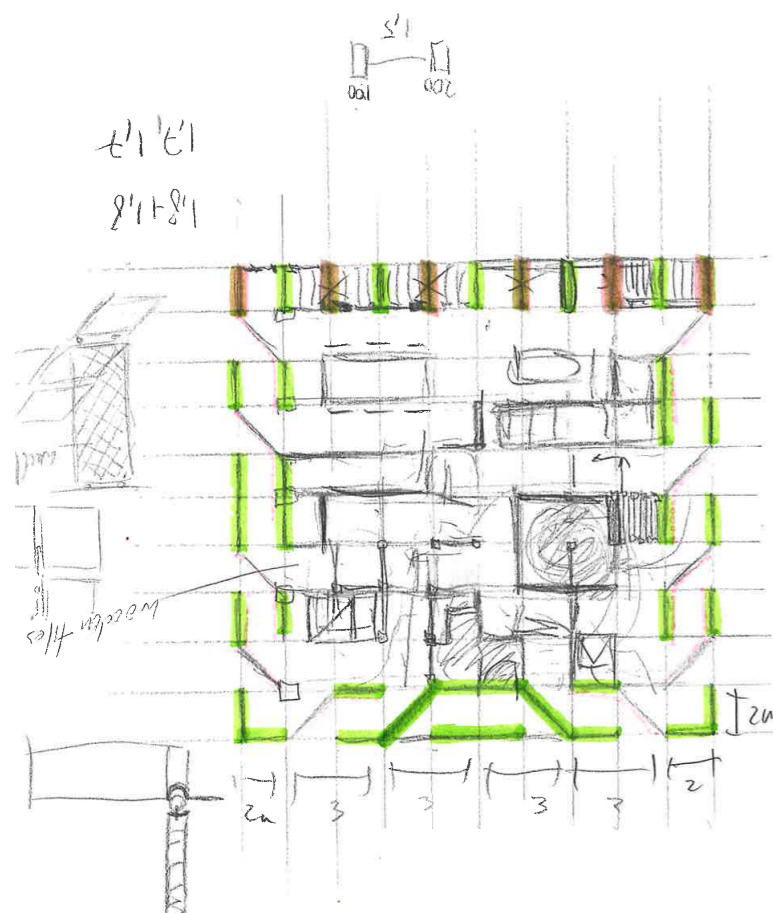

1.11.22

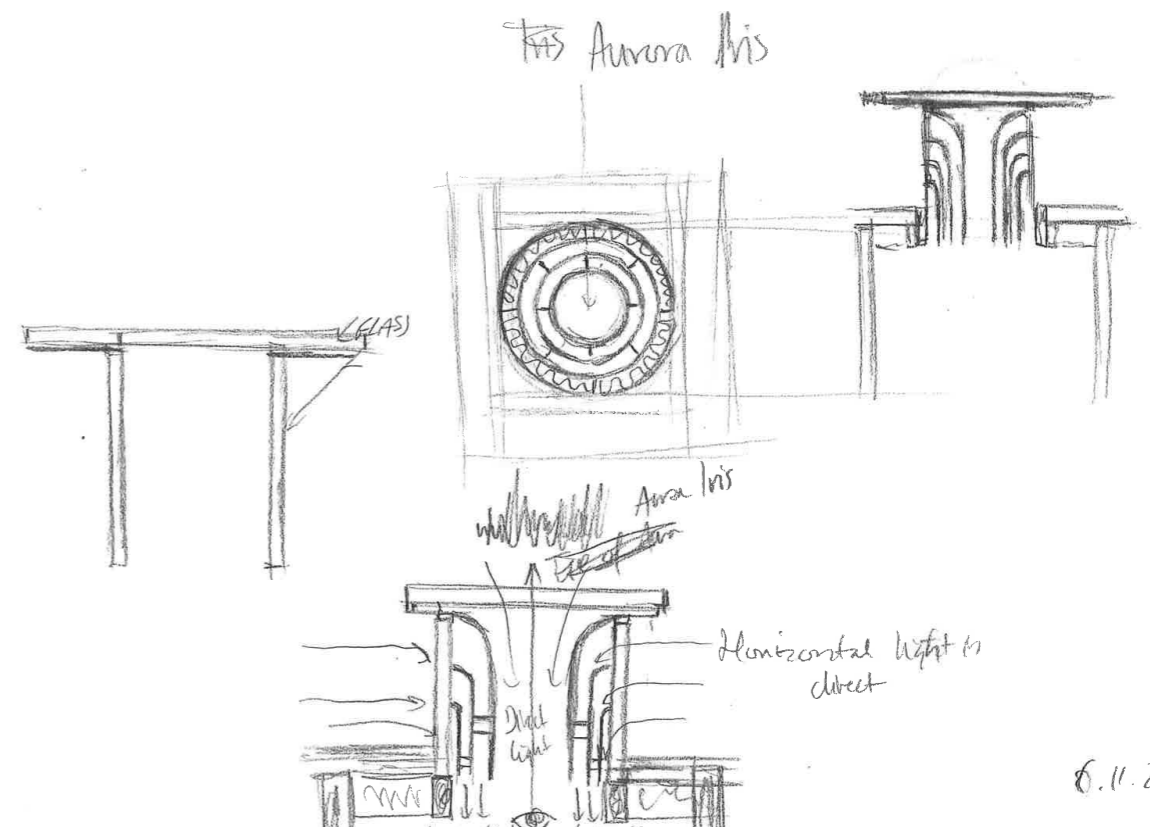

8.11.23

How is facade adapting to various directions on different plots?

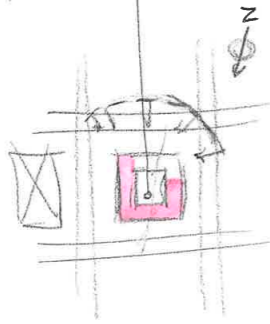
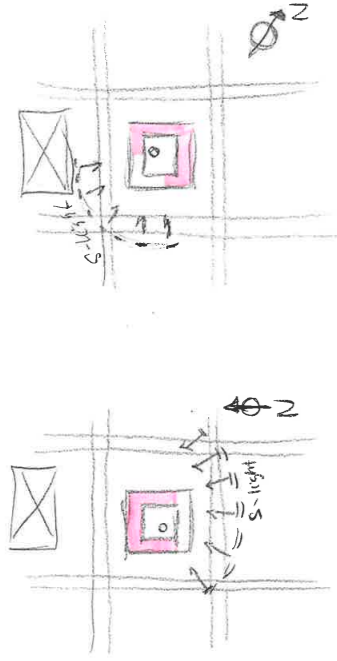

Eastward due to its circular shape it doesn't get affected by directions on the site regarding daylight.

What does she do?

1. Filters lights
2. Catches direct daylight (sun)
3. Distributes indirect light into the core.

straight walls - catches direct sunlight
 (horizontal)
 (vertical)
 (horizontal)
 (vertical)
 (horizontal)
 (vertical)

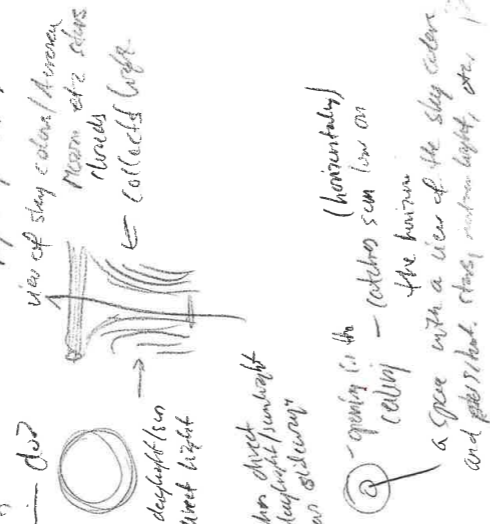

What is a facade in a house?

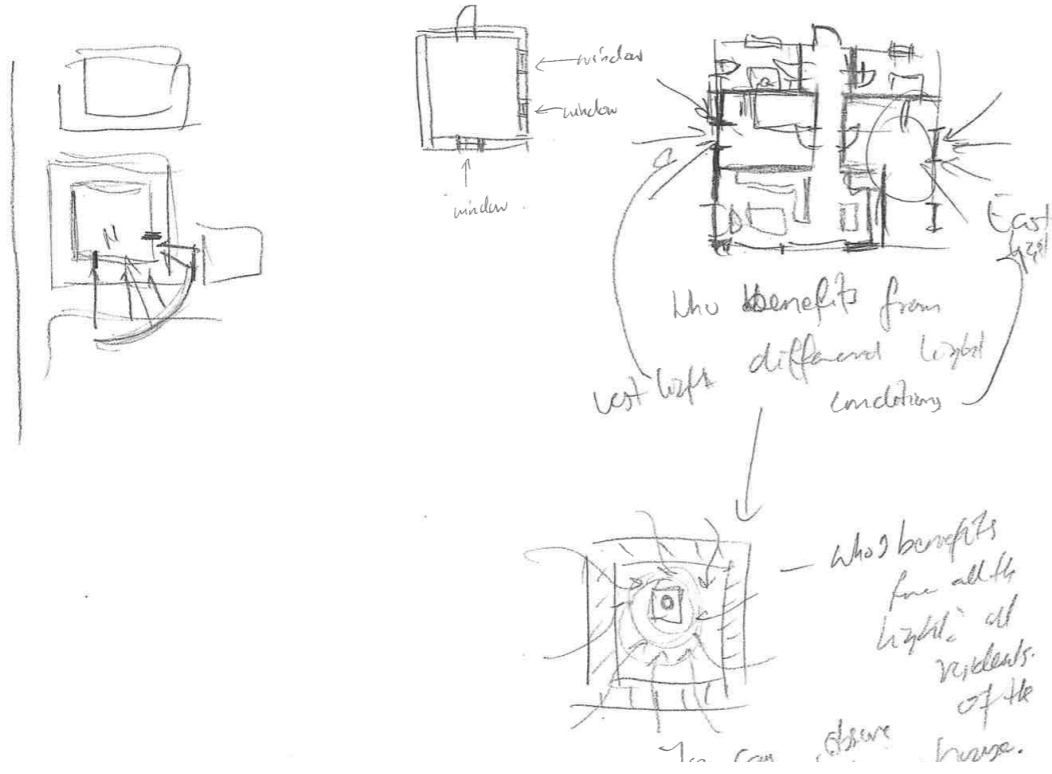

Who benefits from different light conditions?

Who benefits from all the light of residents of the house?

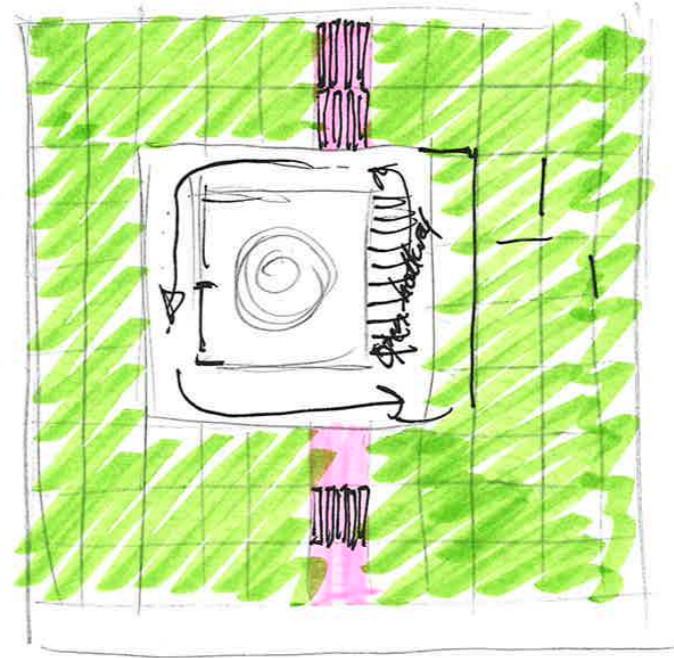
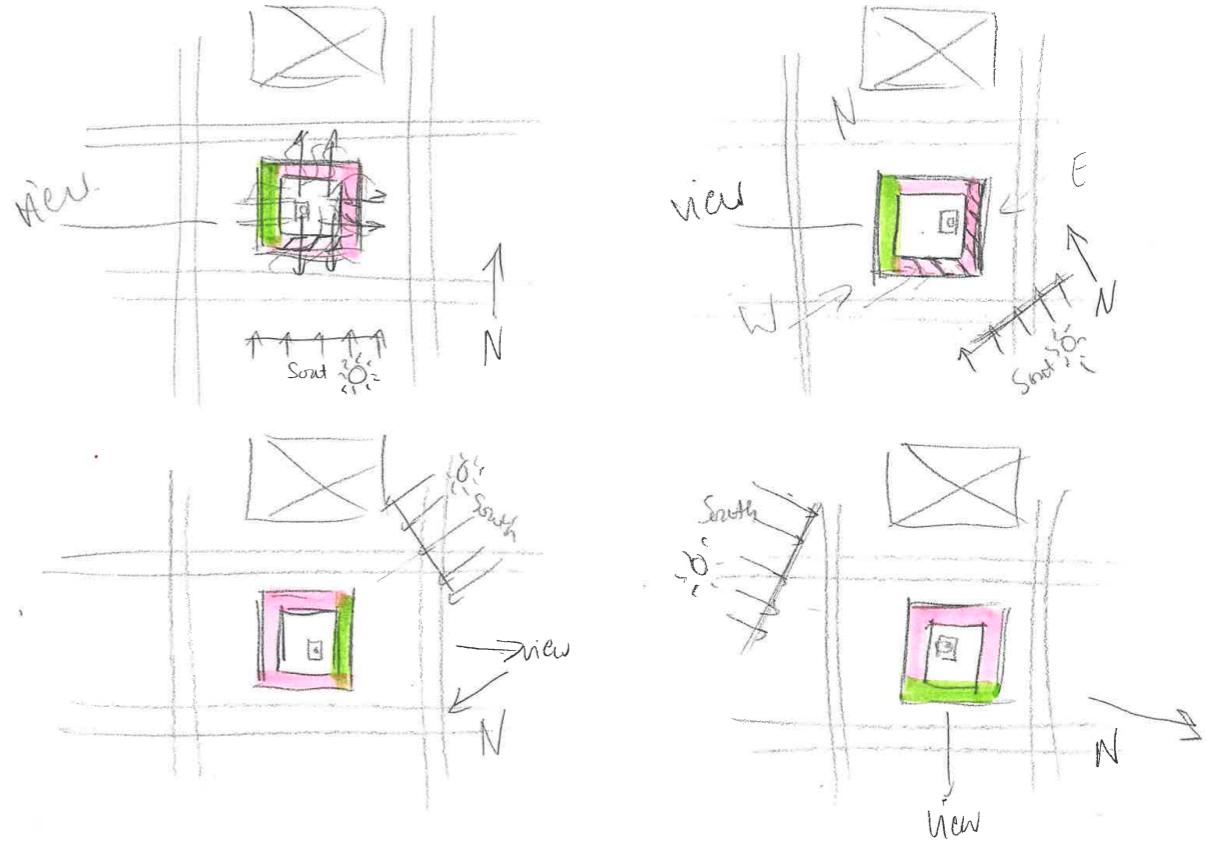

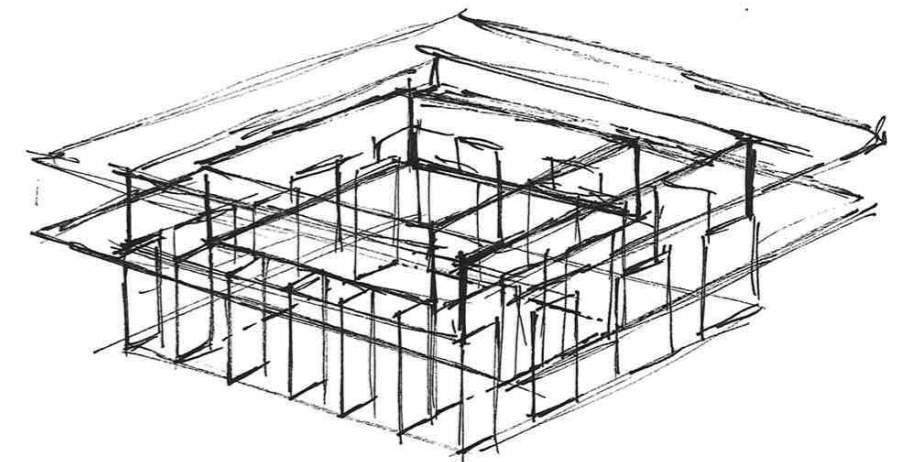
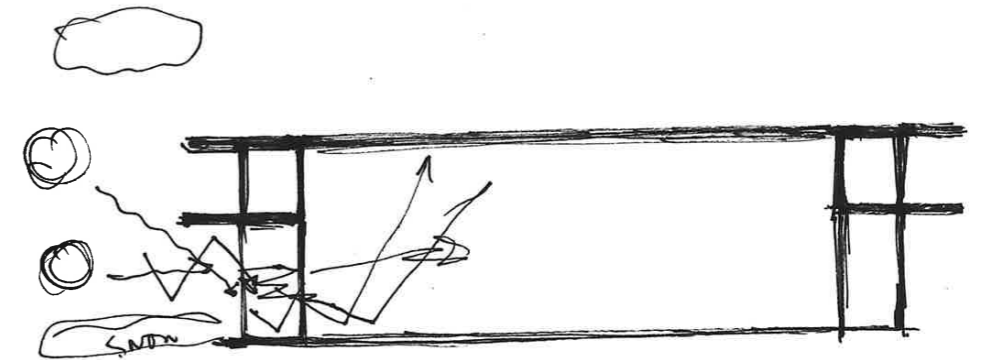
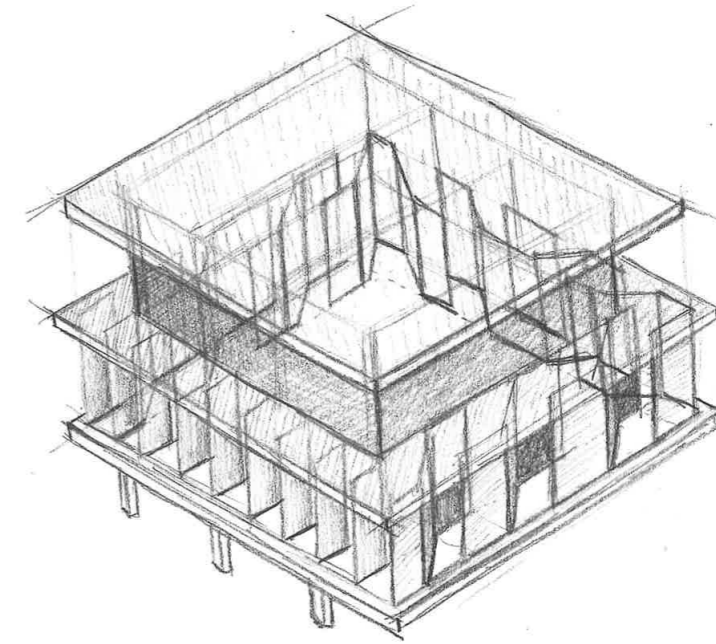
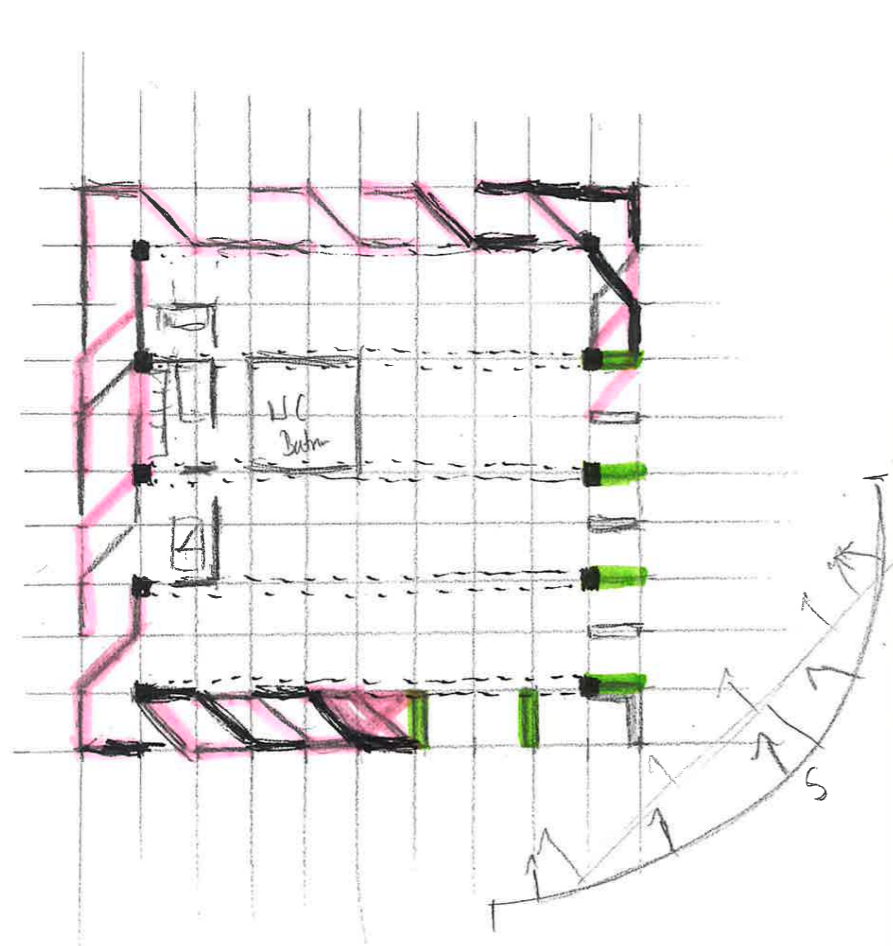
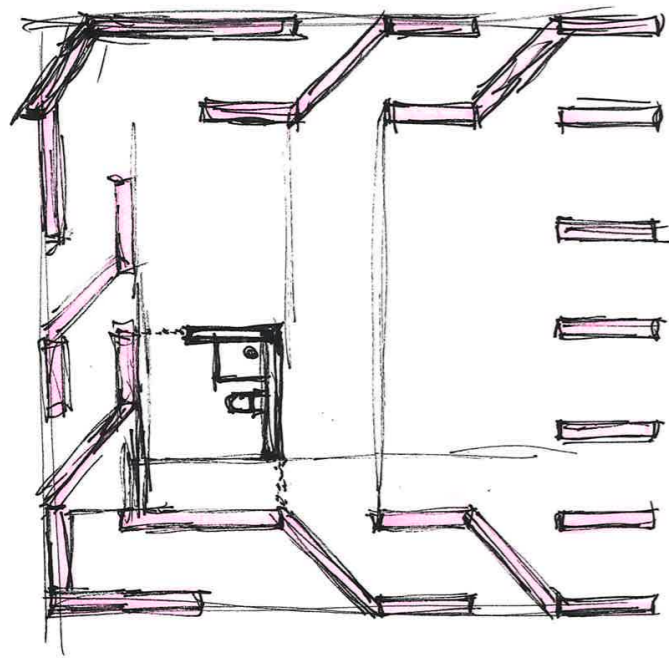

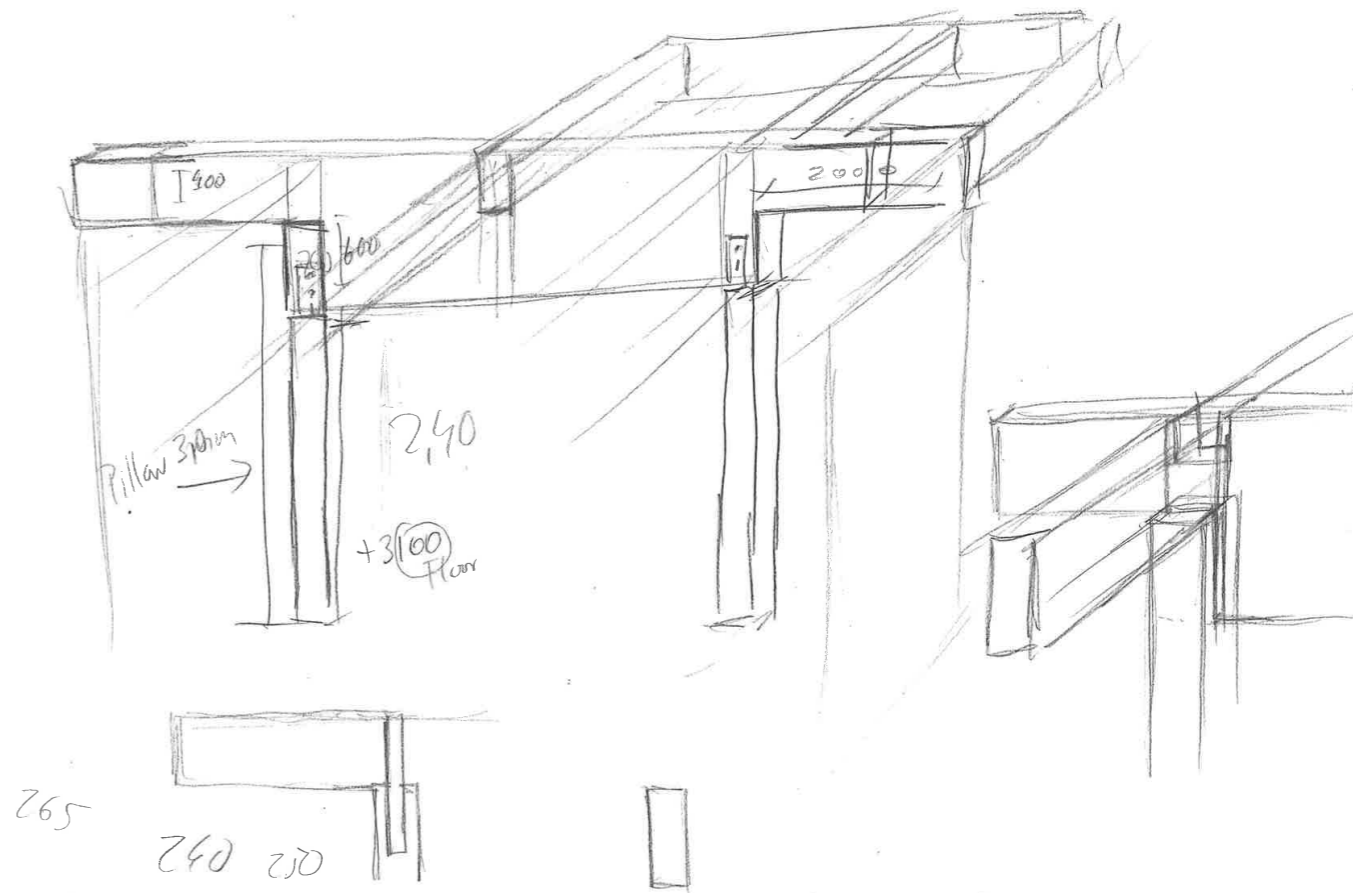
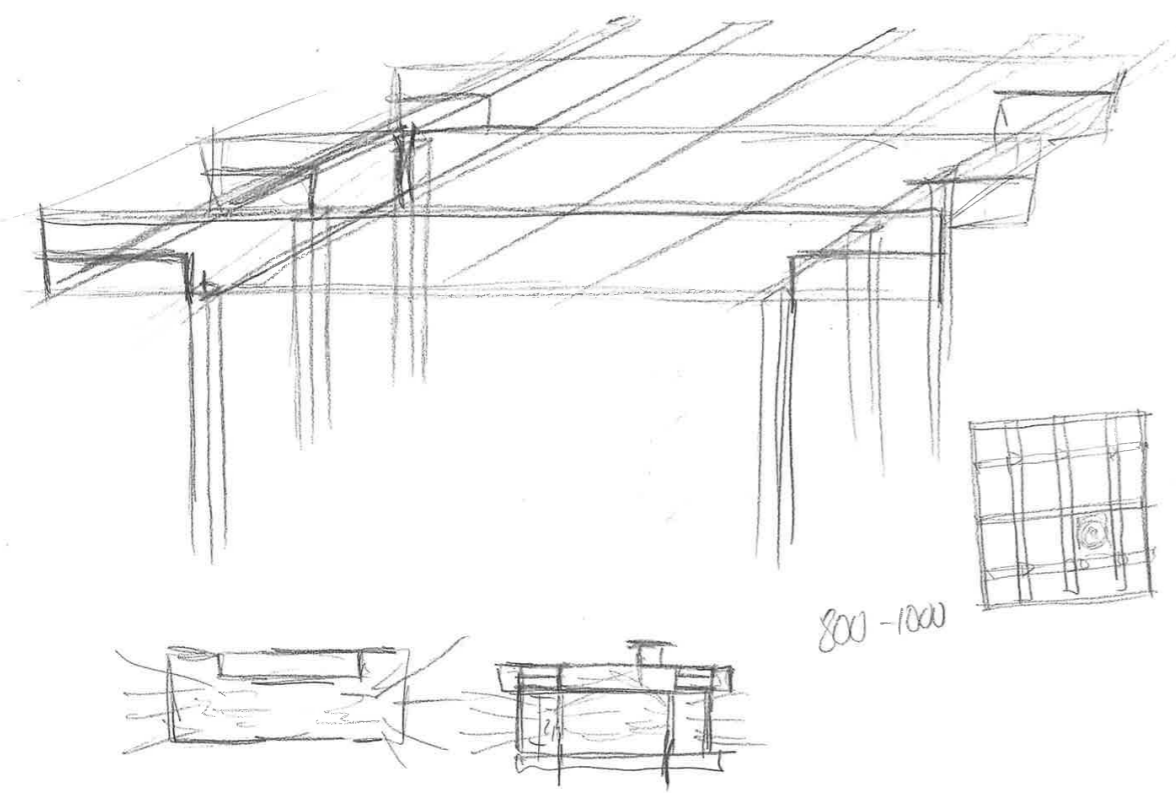
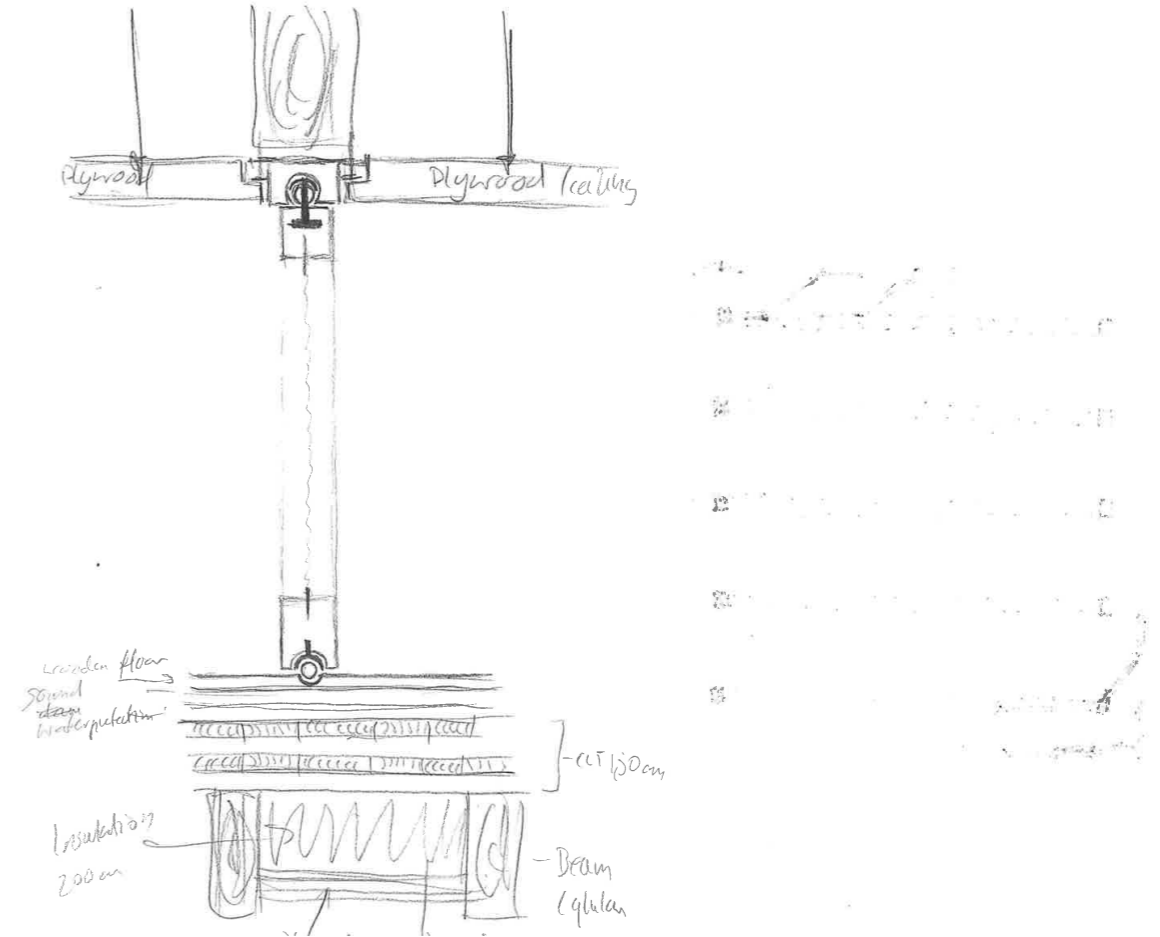
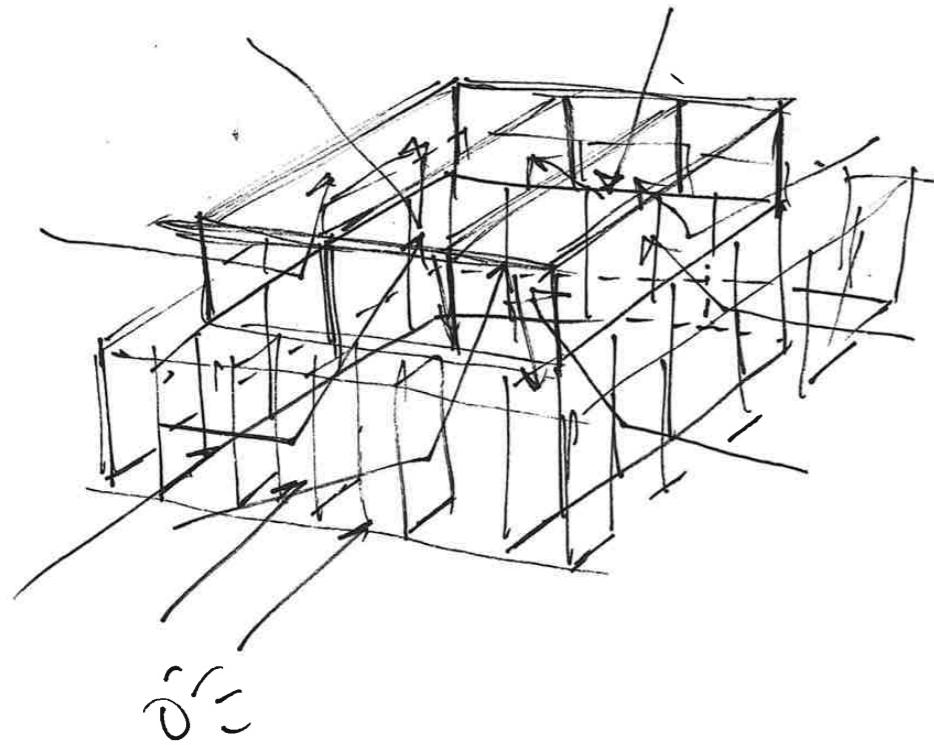

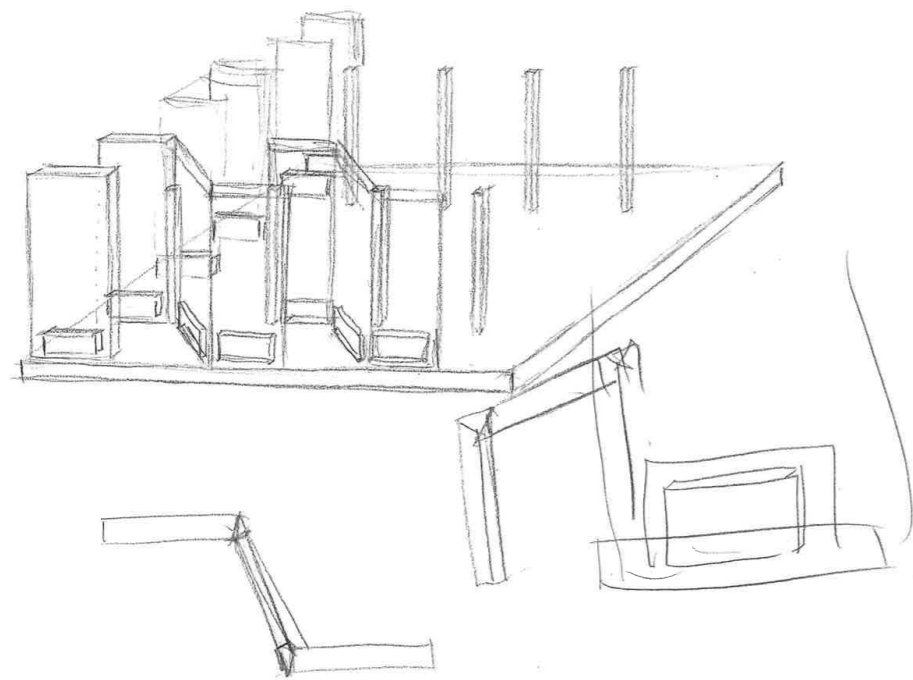

30.10

Ingenjör 2-11.23

Dele opp sektion 2

Beams/pillars - GULAM
 Floor/walls/roof - GULAM
 CLT

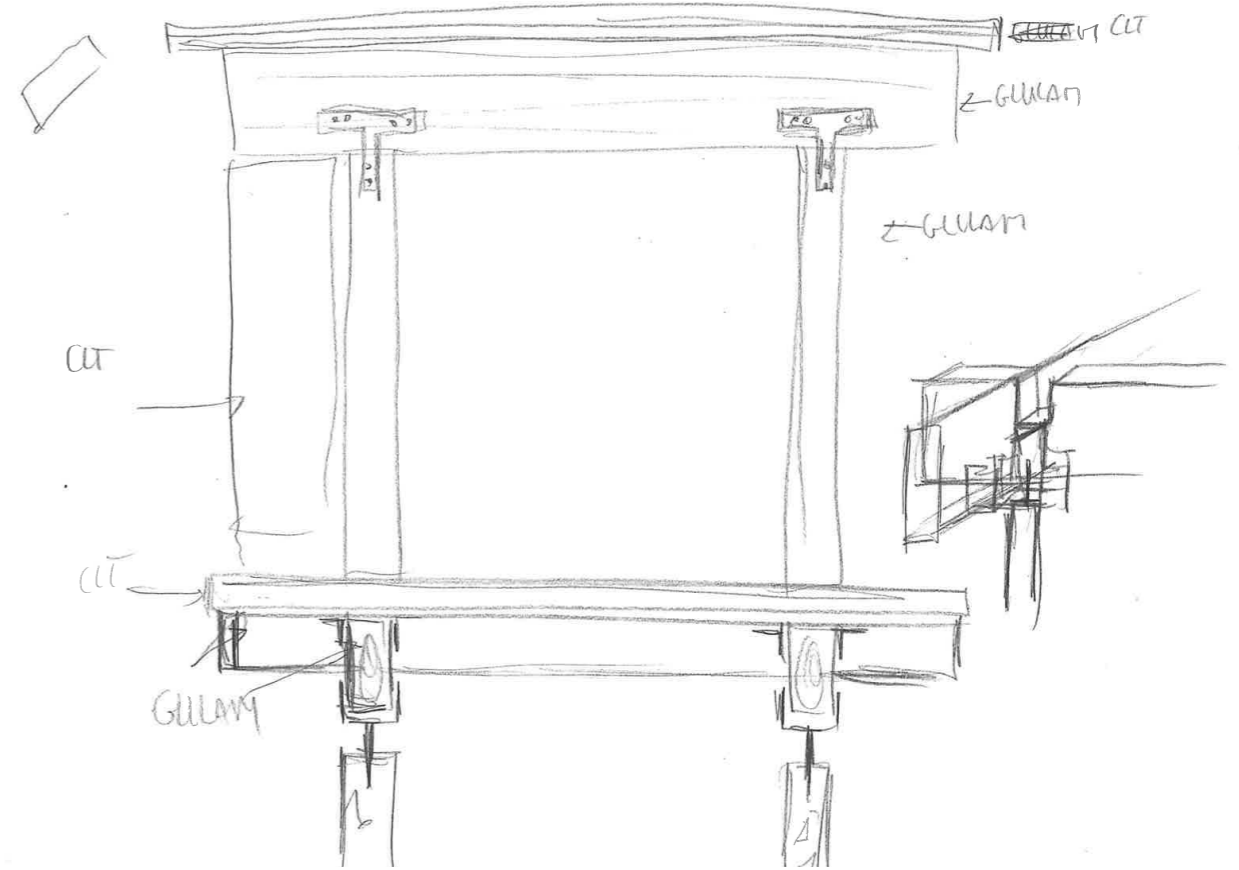
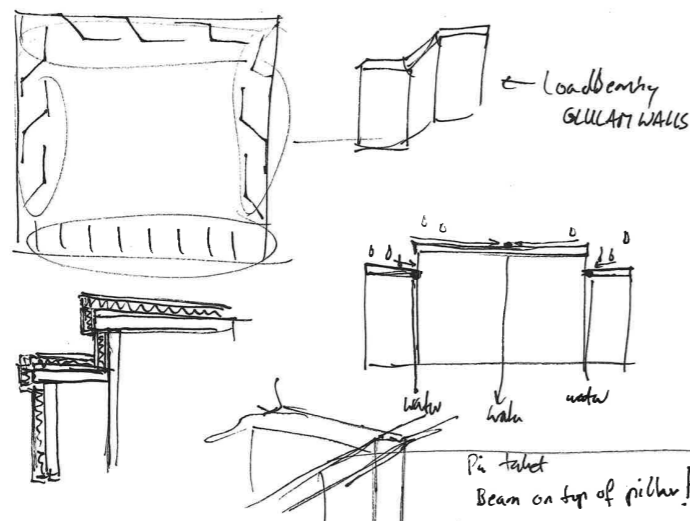
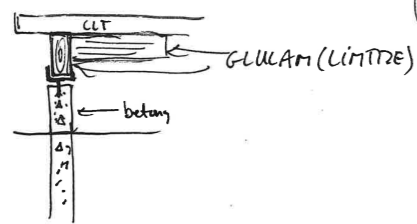

Write down all the
 argument behind the choices
 u have made!

Maria Gunnarsson
 Gunnar Gunnarsson

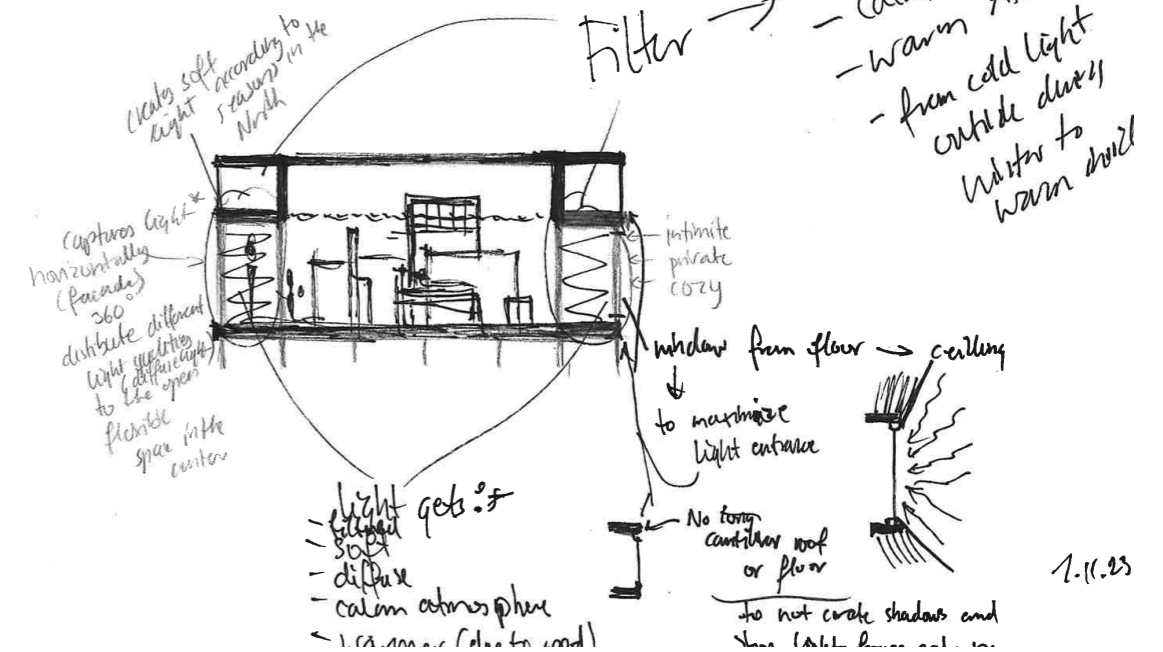

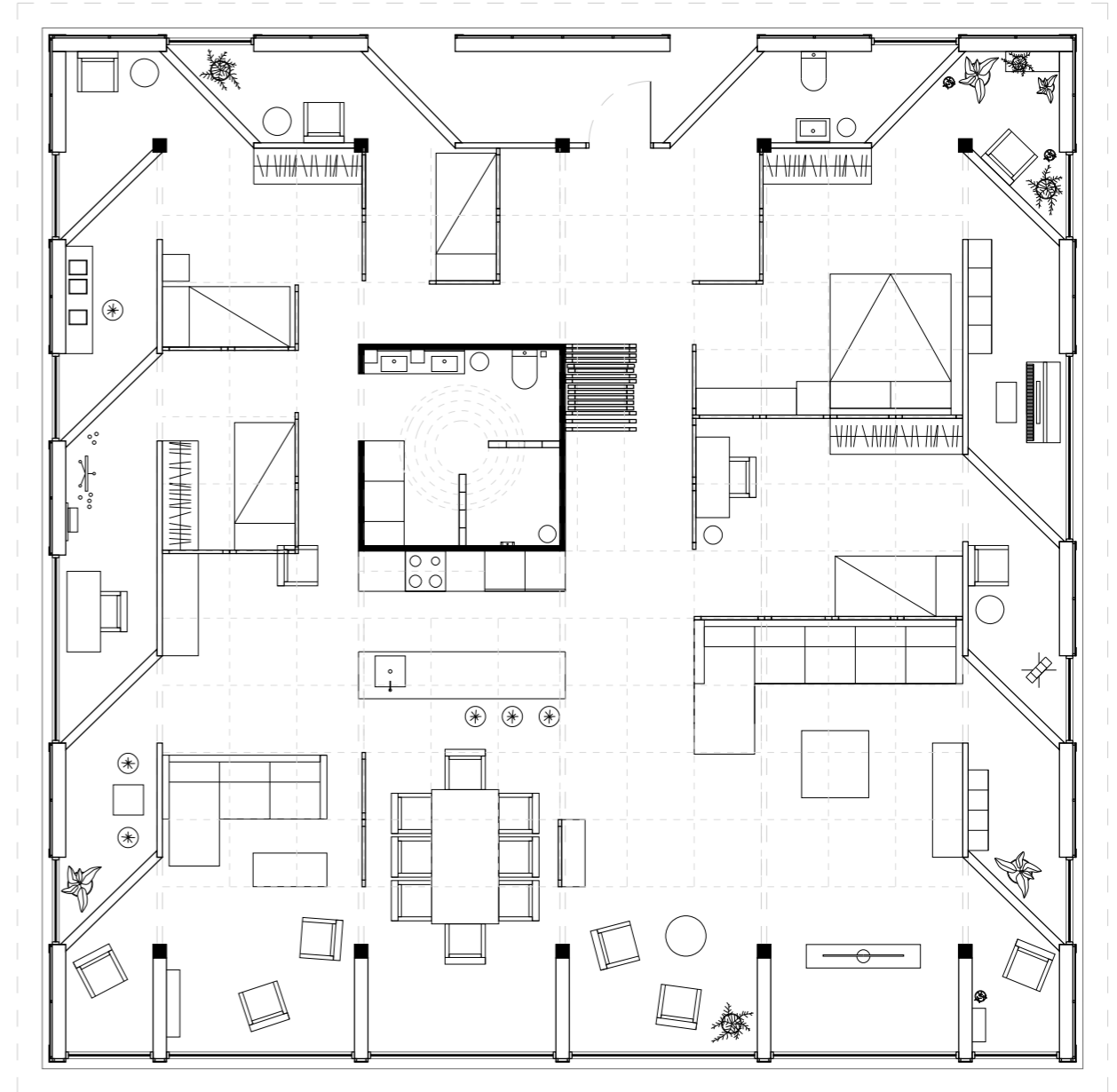
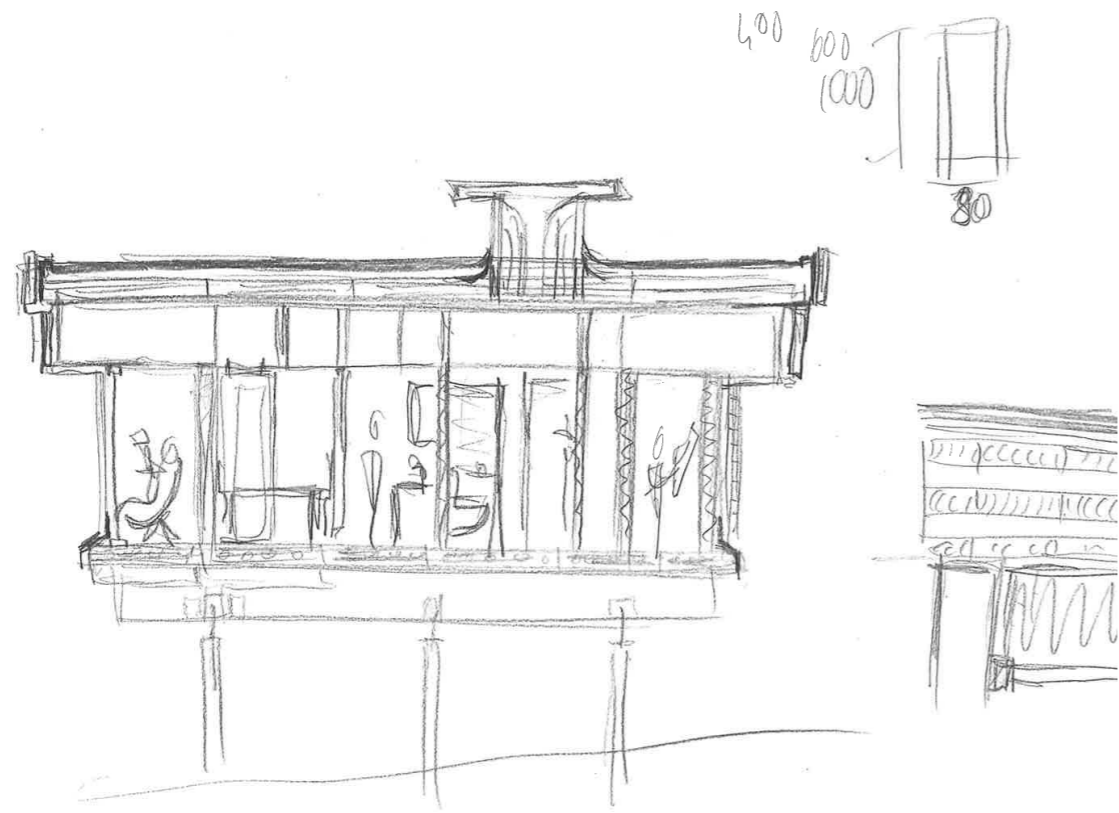

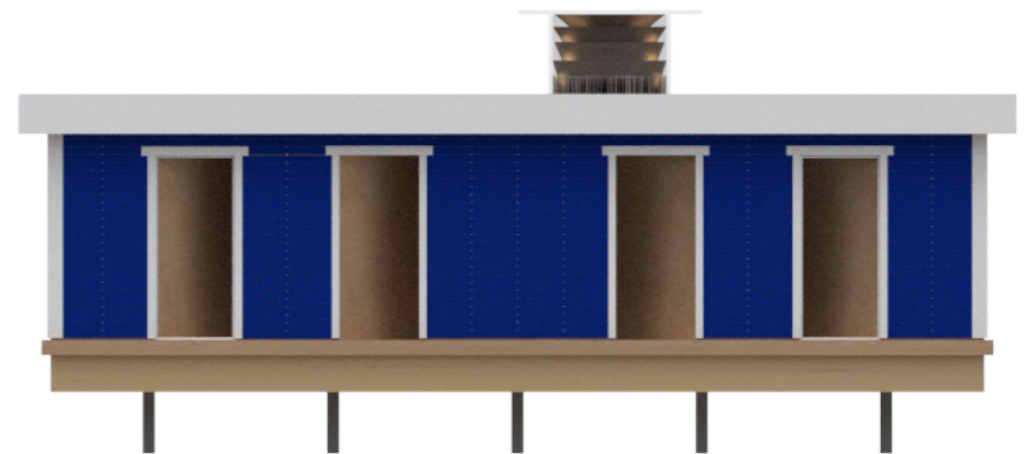
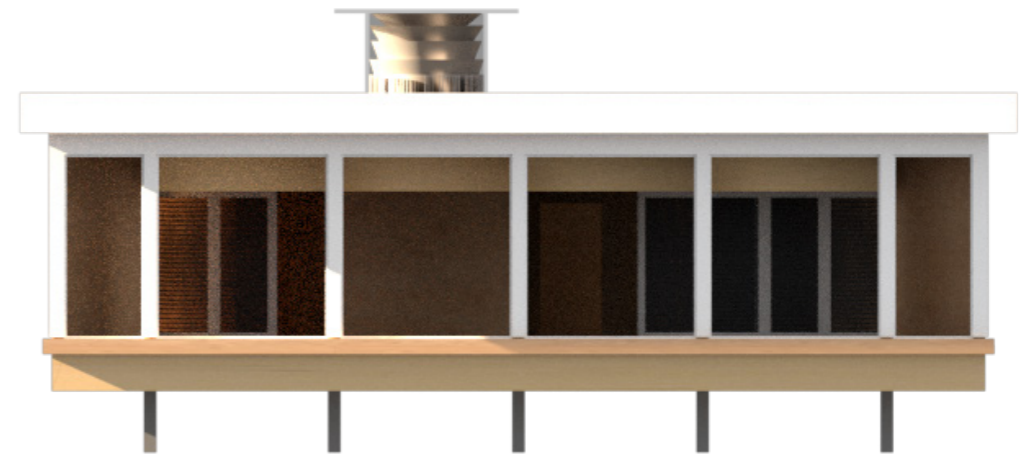
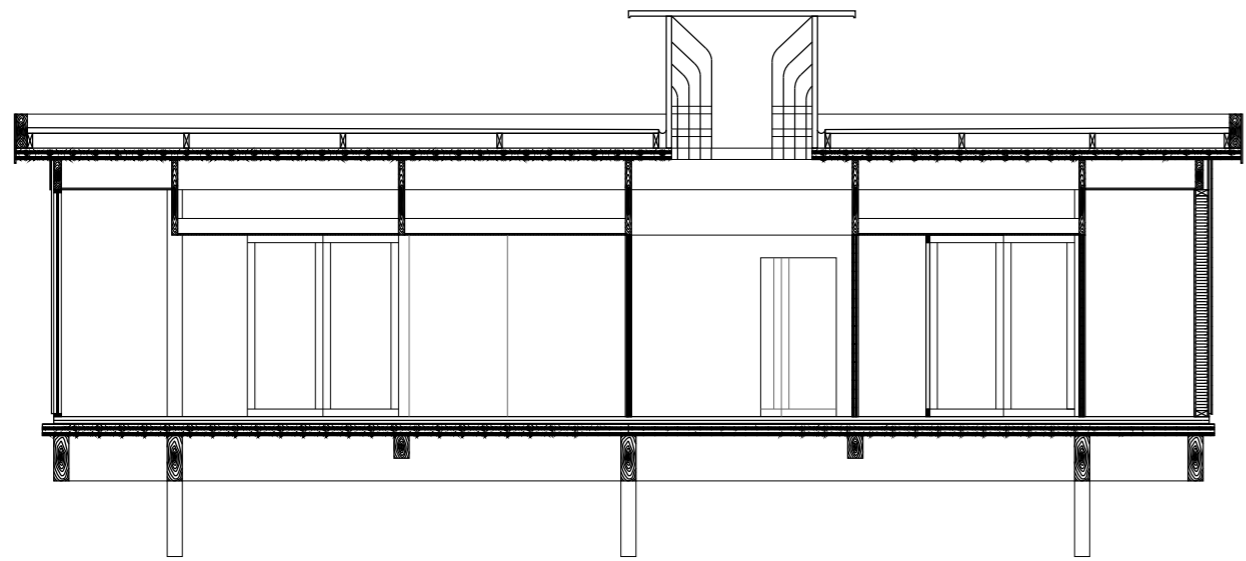

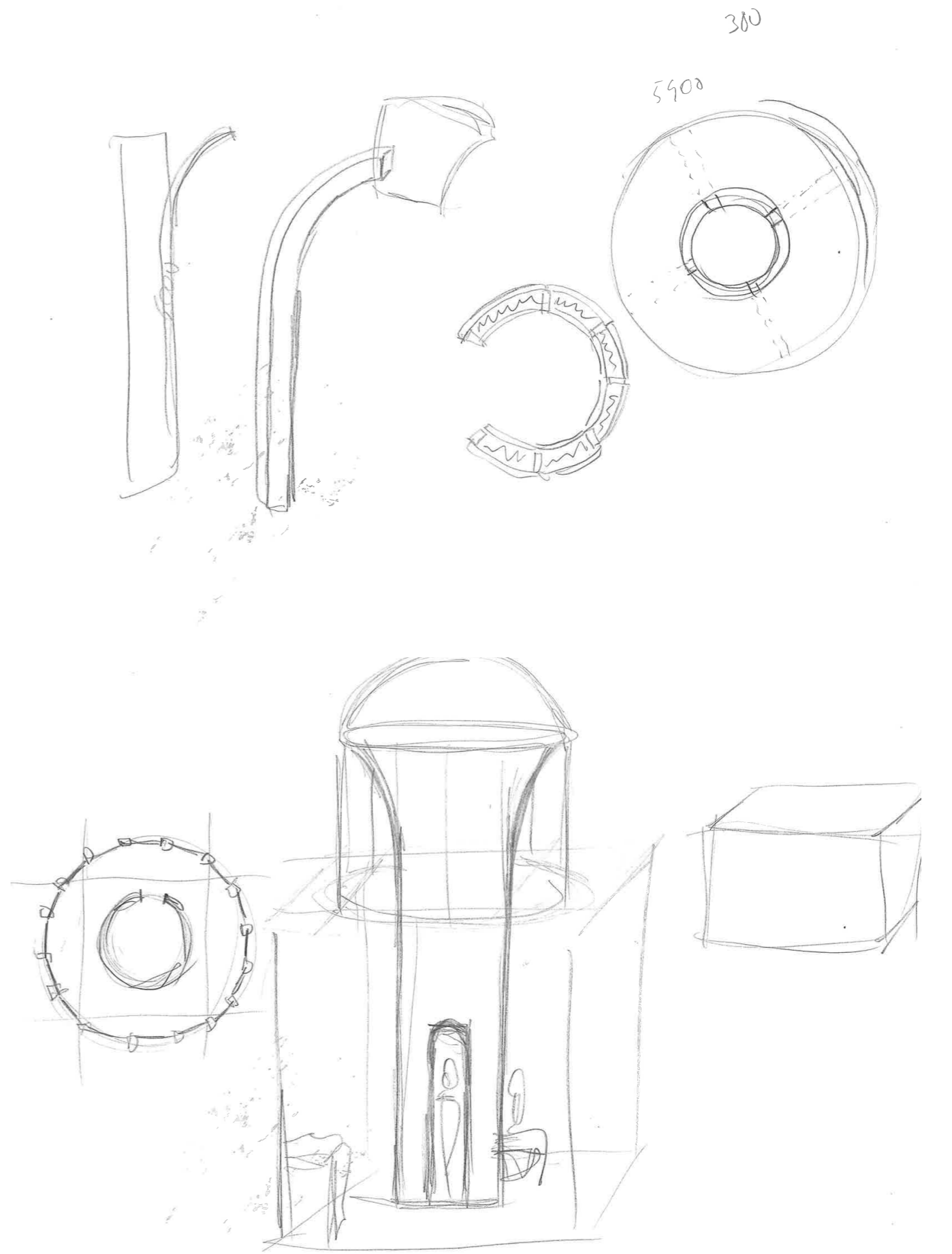
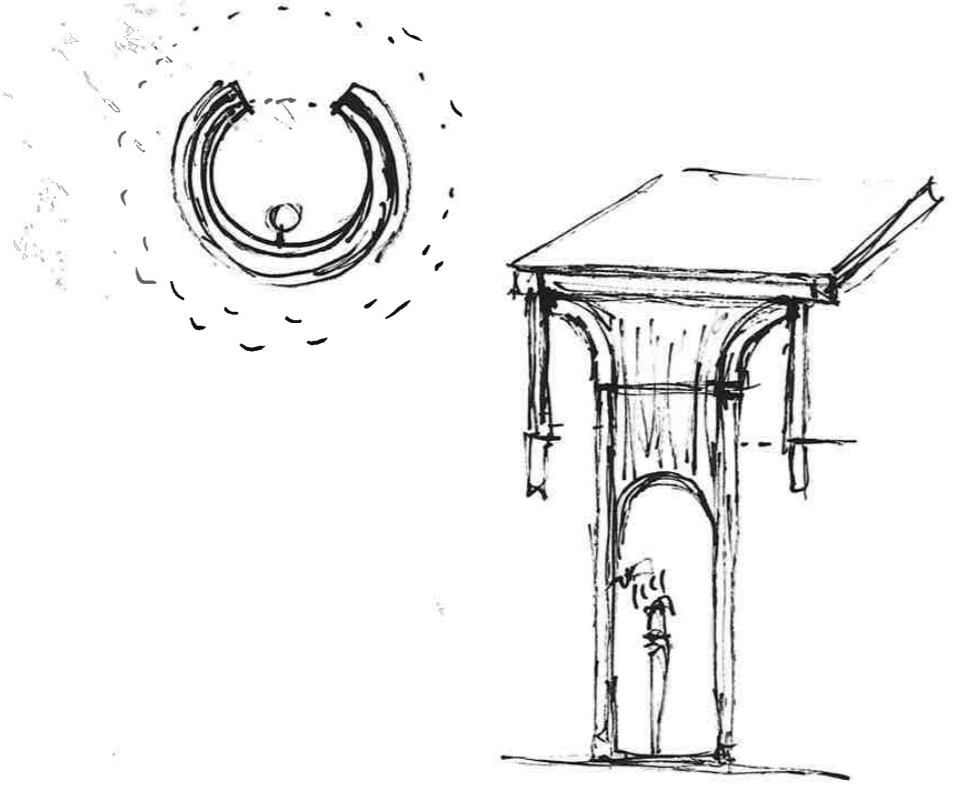
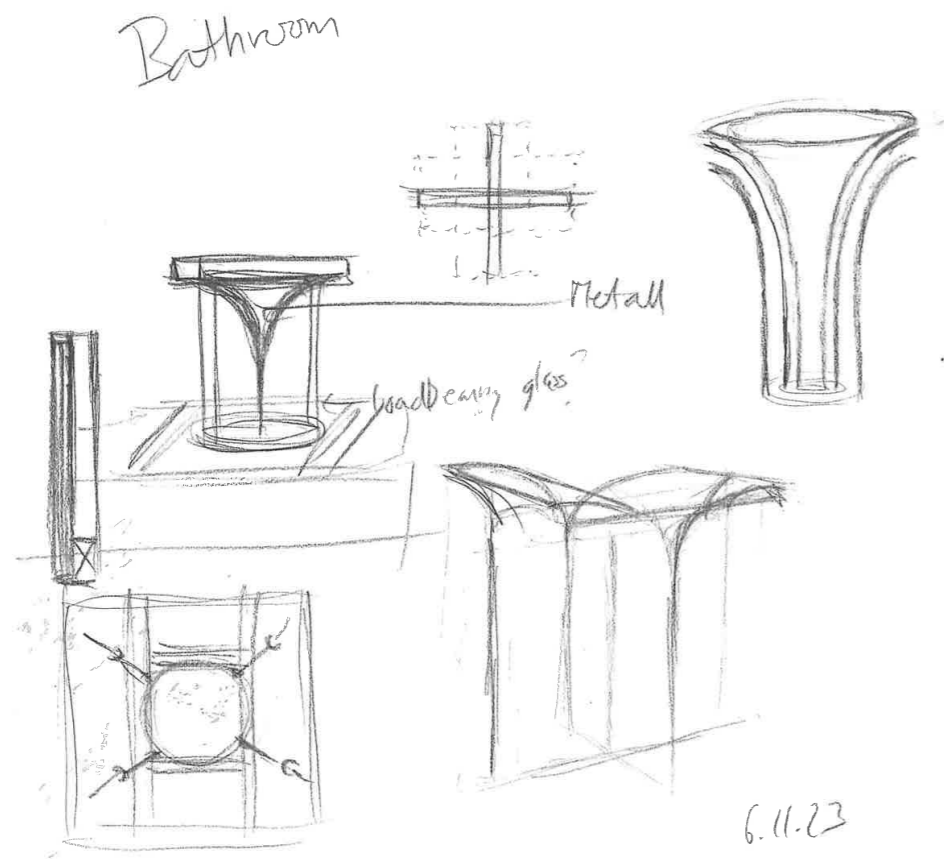

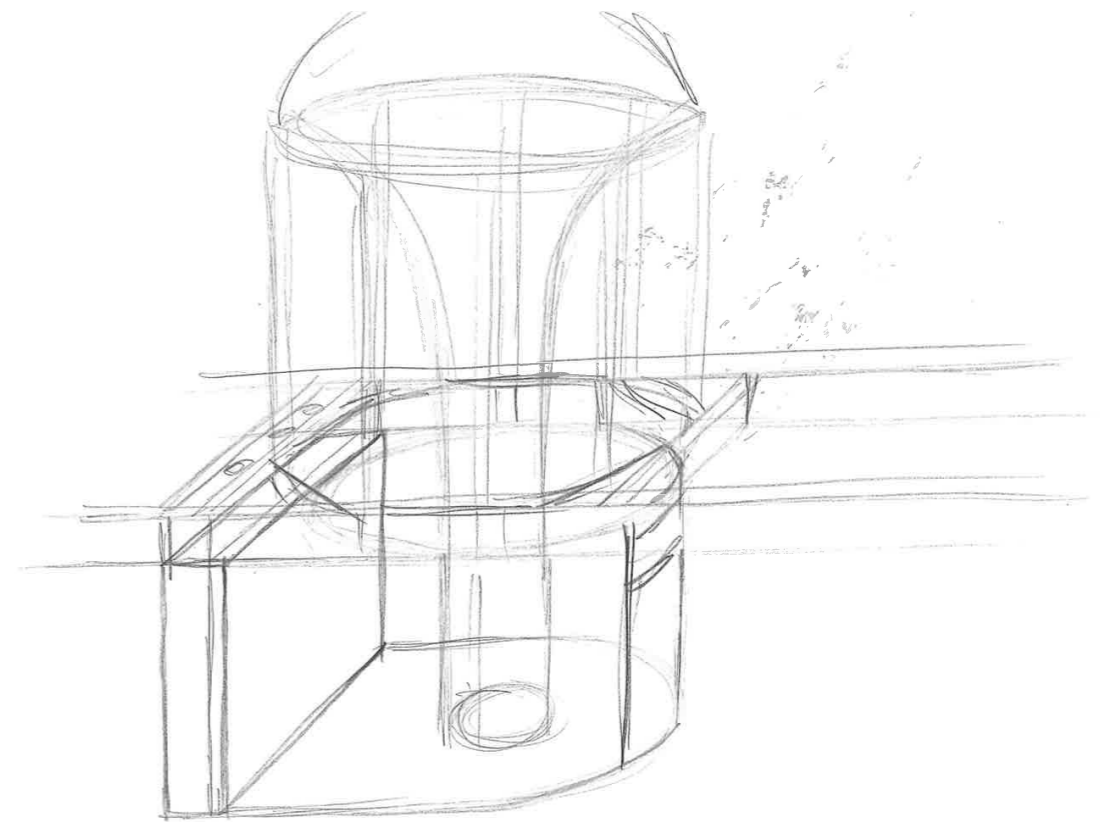
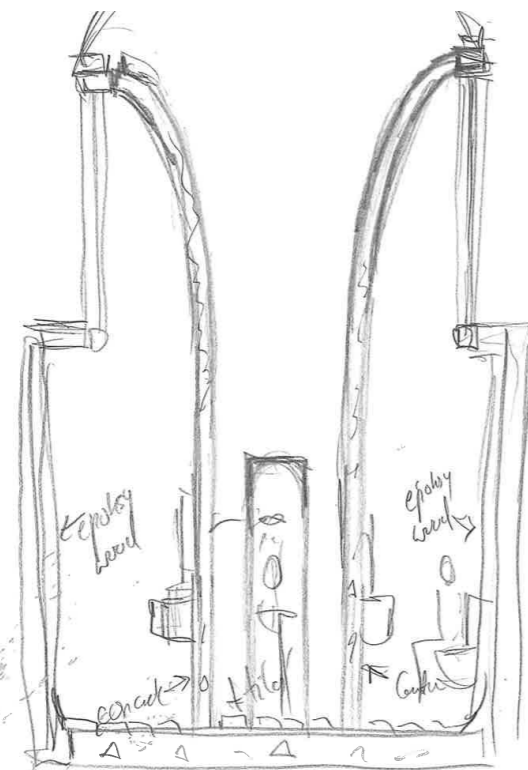
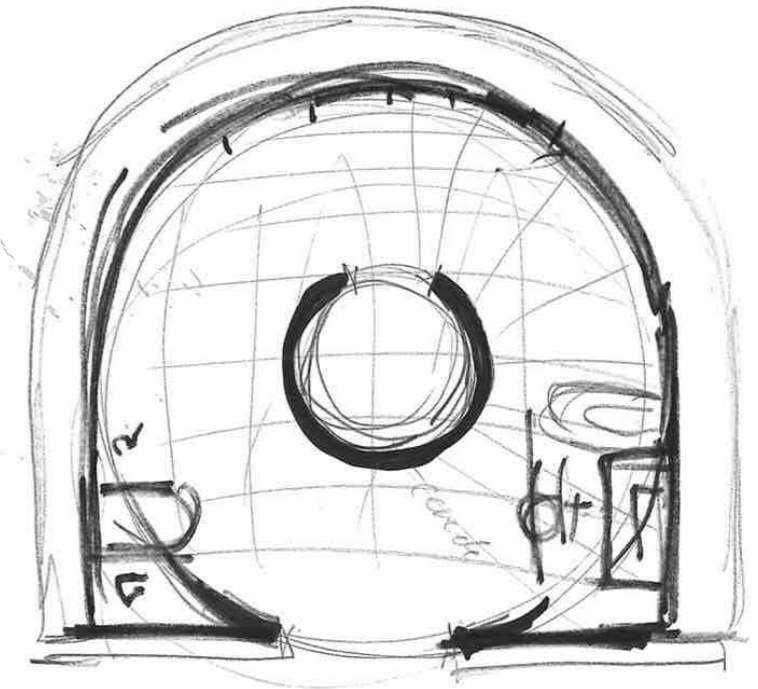
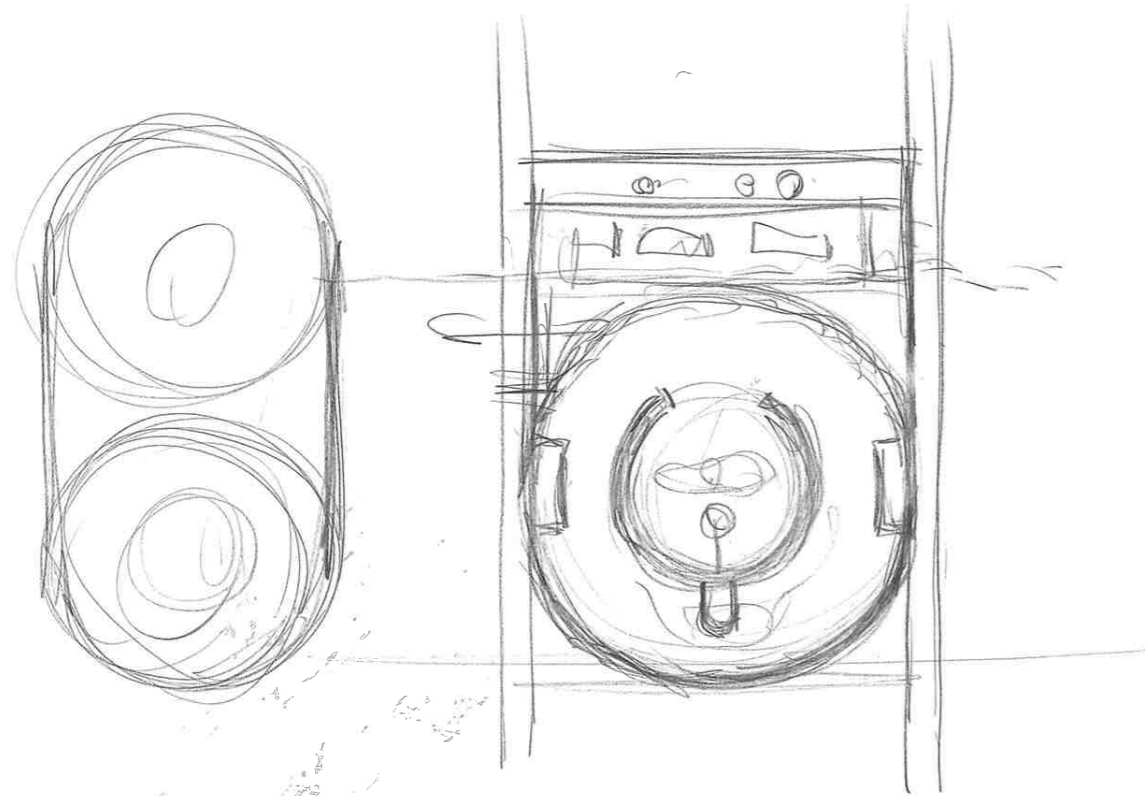

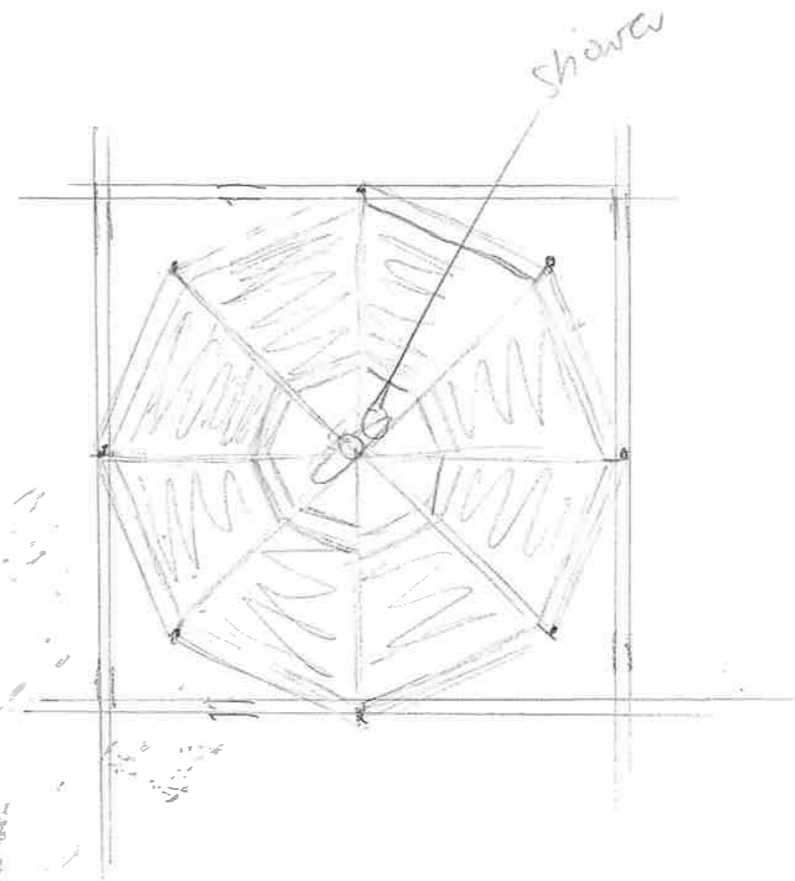
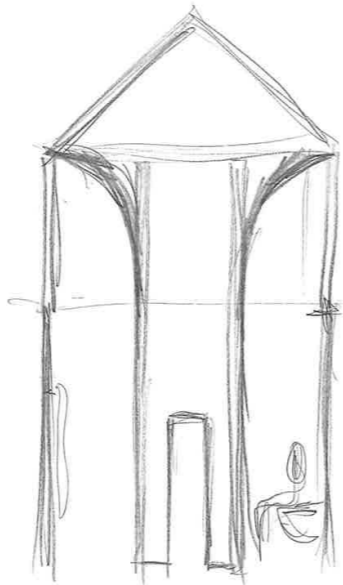
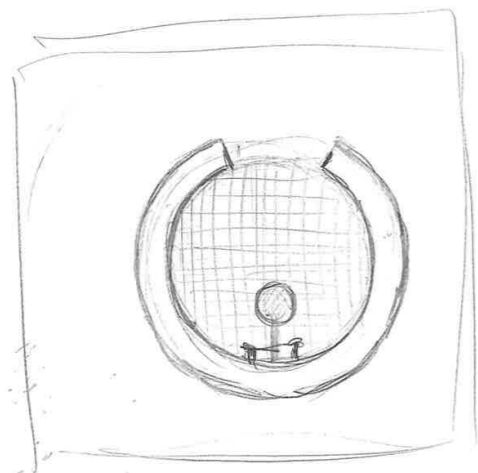
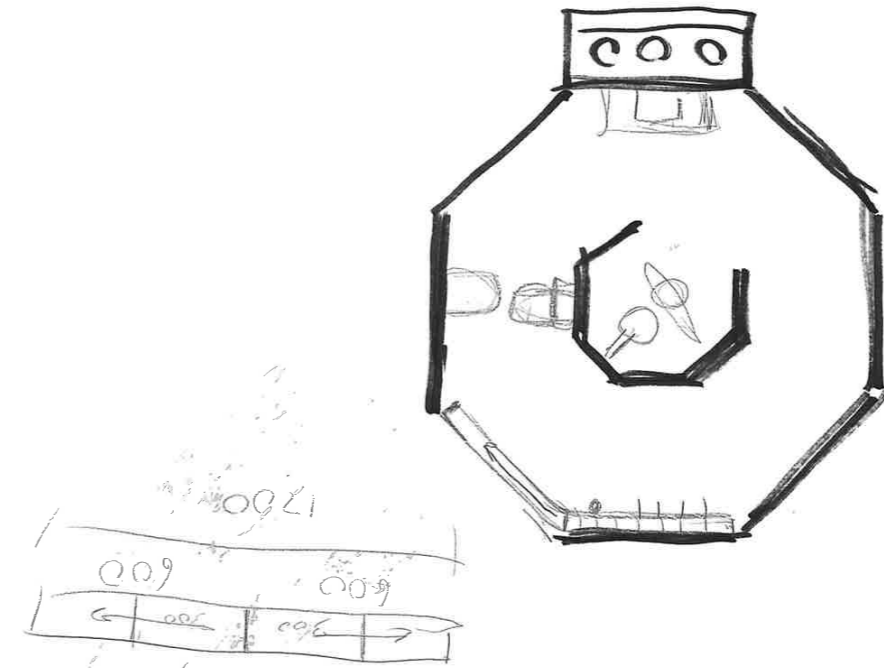
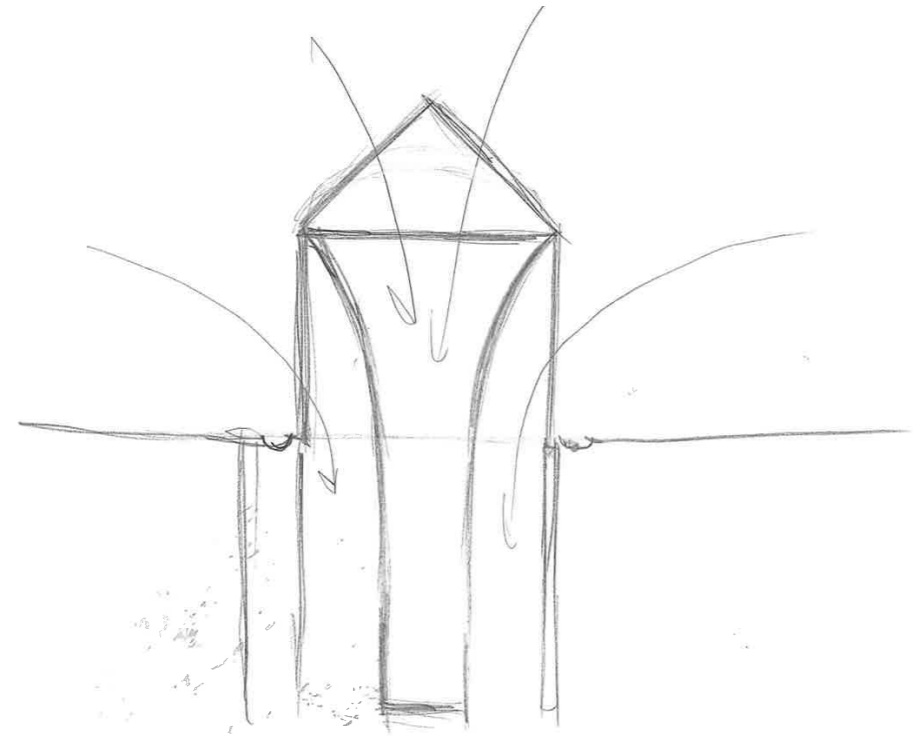

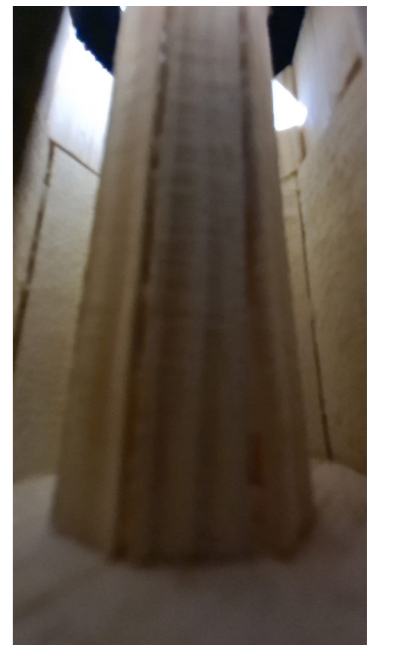
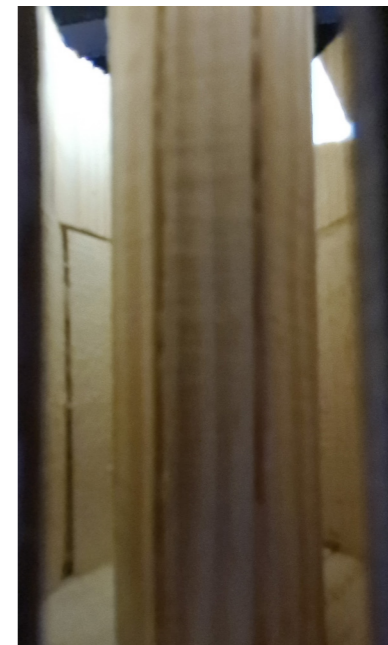
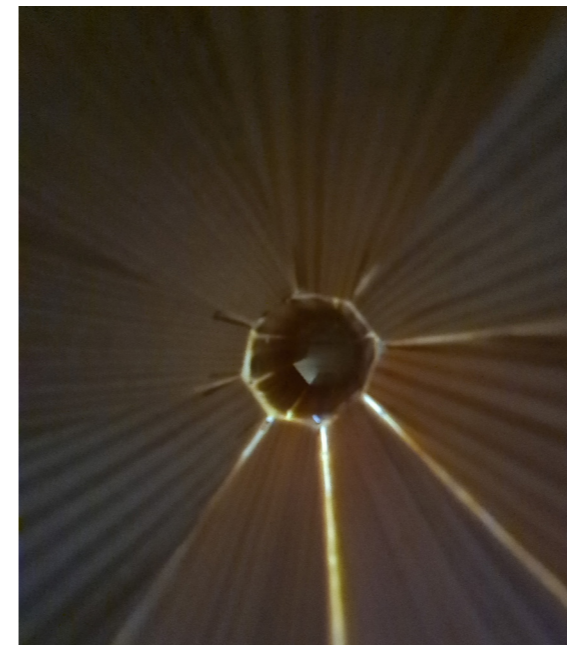
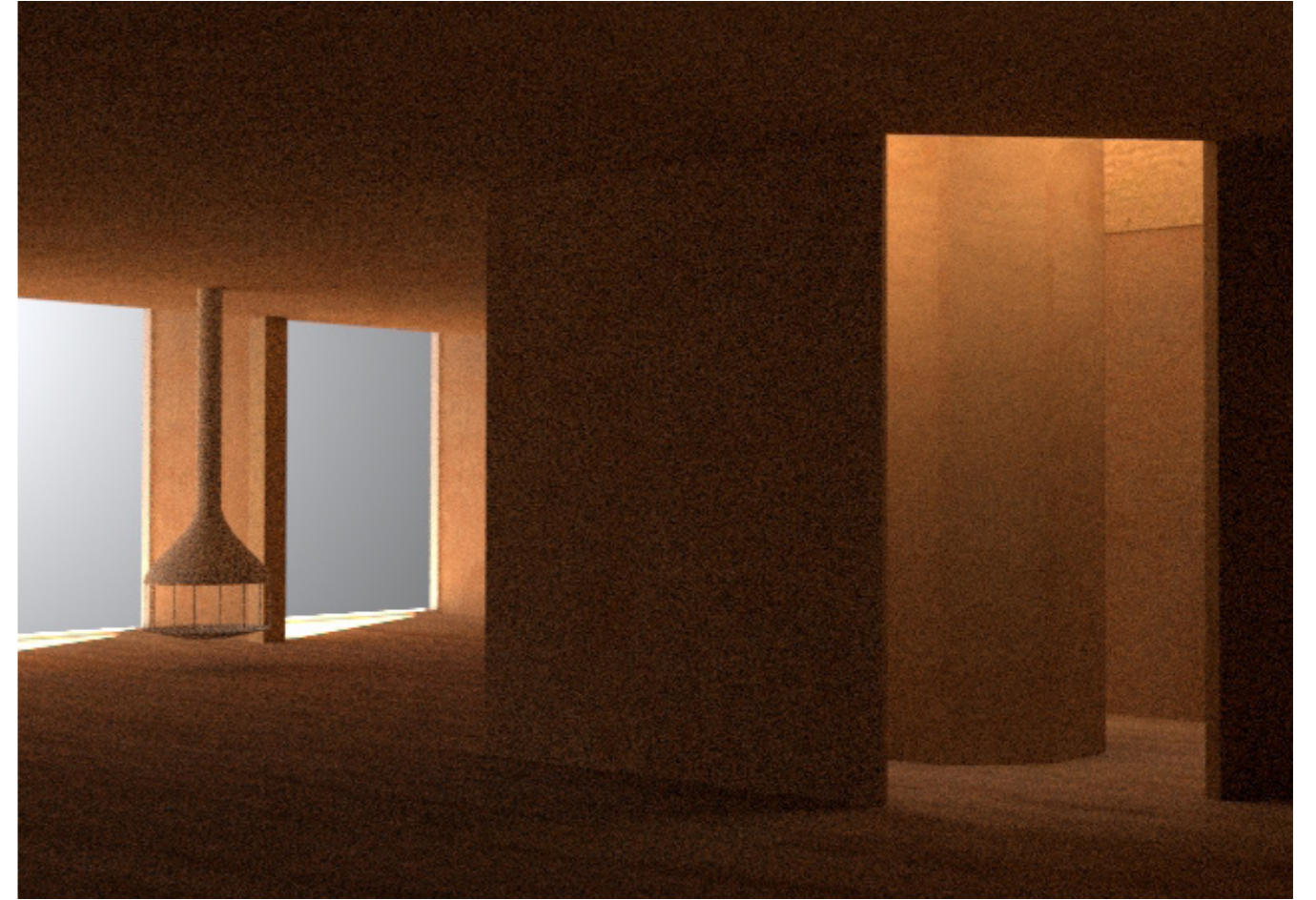
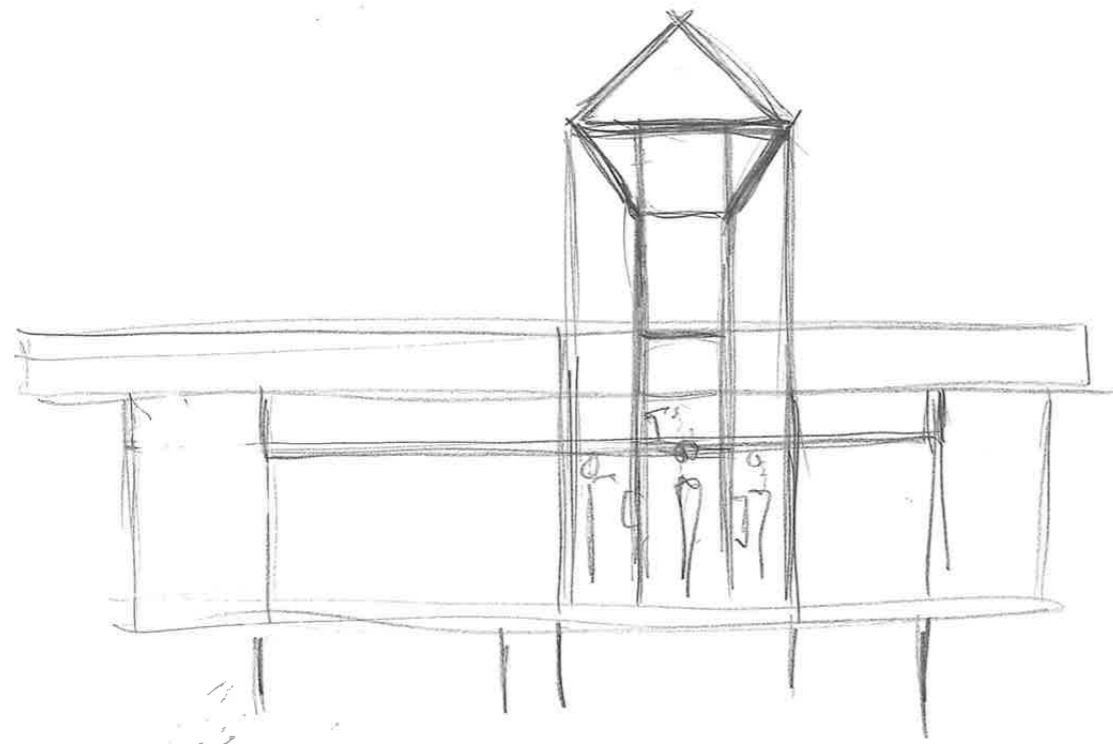

4. FINAL PROJECT

- 4.1 - Project description & Program
- 4.2 - Diagrams
- 4.3 - Construction
- 4.4 - Section - Imaginary life
- 4.5 - Plans
- 4.6 - Specific site
- 4.7 - Interior photos of 1:20 model
- 4.8 - Painting
- 4.9 - Acknowledgements
- 4.10 - Dedication



MODEL SCALE 1:20



Dwelling in Light - 70° N takes a new approach to single-family house typology within Arctic Norway. Based on a fundamental component of our daily life routine, daylight, it has guided the very characteristic of this specific outcome. The leveled floor plan is harmonic, mediating with daylight through four equal in length and height pendicular facade walls. One glazed wall is completely exposed to its circumstances; the other three facades filter the strong horizontal light through an arrangement of diagonal walls within a grid of 3x1.5m. Niches, being in between spaces, reflect the light rays, filtering the cold outdoor light into a warm, honey-like glow. The light experience given by the niches is both a shared occasion and a more intimate moment. Within the main 3x3m grid, a timber-framed structure covered with epoxy-treated plywood plates rises above the flat roof structure. It appears as a transparent crystal to the public due to its glazed octagonal base shape. The outer layer of the funnel-shaped shower within the bathroom captures light from a 360° angle, bending the light down to floor level, while the inner part gives a vertical view of changing skylight, as well as an observation point for light phenomena that occur in the arctic. The concrete pillar foundation allows for smaller excavations in the ground, along with adaptability to irregular terrain conditions. A glulam structure is placed along the axes of the pillar foundations, which are covered with CLT slabs. The roof's glulam beams span across the whole building on mirrored load-bearing glulam pillars. Due to the stair-like shape of the beams, they diversify the height within the inner core and the filter wall areas. The core is 2.4m from floor to ceiling, while the niches are 3 m high. The use of timber in the exterior and interior parts of the house emphasizes the material connection with its context, as well as the fact that the wood transmits warmer light from its reflections in an otherwise harsh and cold environment.

- Single family-house
- Around 200 sqm
- Access to daylight in every space
- Max 2/2,5 floors
- Max height 9m-regulations (can be lower depending on context)
- No basement in the ground/ no large excavations on the plot.
- Kitchen
- Living room
- Bedrooms
- Bathroom



*In additon to the base of the program I am including findings from the research that guided development of the project: BLUE colored words are included

SURVEY:

Most favorite rooms + <<Daylight is an important factor in why this is my favorite room>>

- LIVING ROOM 
 - LARGE WINDOWS
 - LIGHT CONDITIONS
 - VIEW
 - SPACIOUS
- KITCHEN 
 - BRIGHT
 - SOCIAL ROOM
 - LIGHT CONDITIONS
- BEDROOM 
 - DARK
 - VIEW
 - RELAXING

Least favorite rooms + <<Daylight is an important factor in why this is my least favorite room>>

- BATHROOM  = WINDOW/S
- HALLWAY  = PART OF OPEN FLOOR PLAN
- STORAGE ROOM  = PART OF OPEN FLOOR PLAN

PROFESSIONALS - ARCHITECTS

- **Observe light 24h**
- **Windows up to the slab**
- **Sun hits more horizontally in the North**
- **Qualities from all celestial directions**
- **Snow and reflection from it**

CASE STUDIES

- **Having windows placed mostly along the facade**
- **Open plan floor**
- **Angles/angled walls**
- **Construction/facade materials reflecting existing architectural language**

FOUNDATIONS

- Adaptation to the terrain

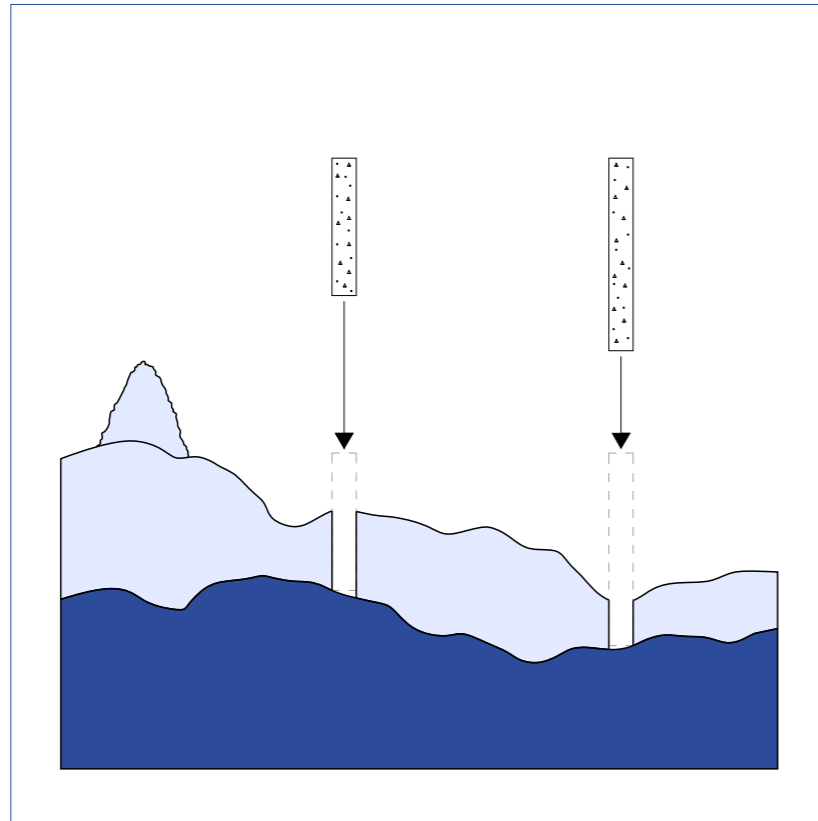

WALLS

- Equal length of the walls
- Creates closer relationship to the movement of light

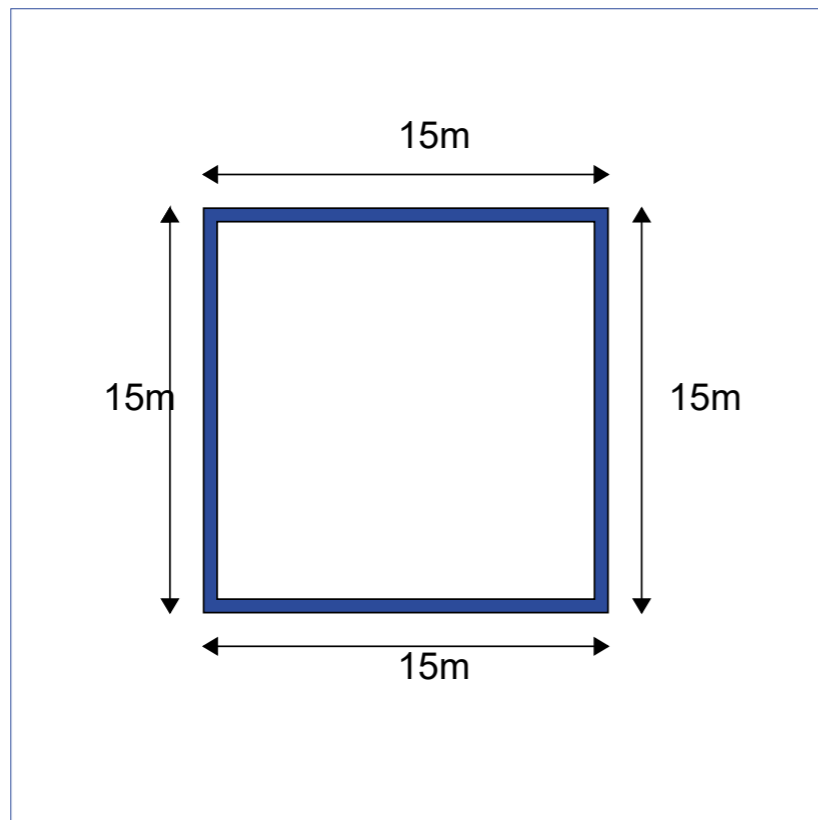

1 FLOOR PLAN

- Private ■
- Semiprivate ■
- Common space* ■

* Common space can become a more intimate one in relation with a niche

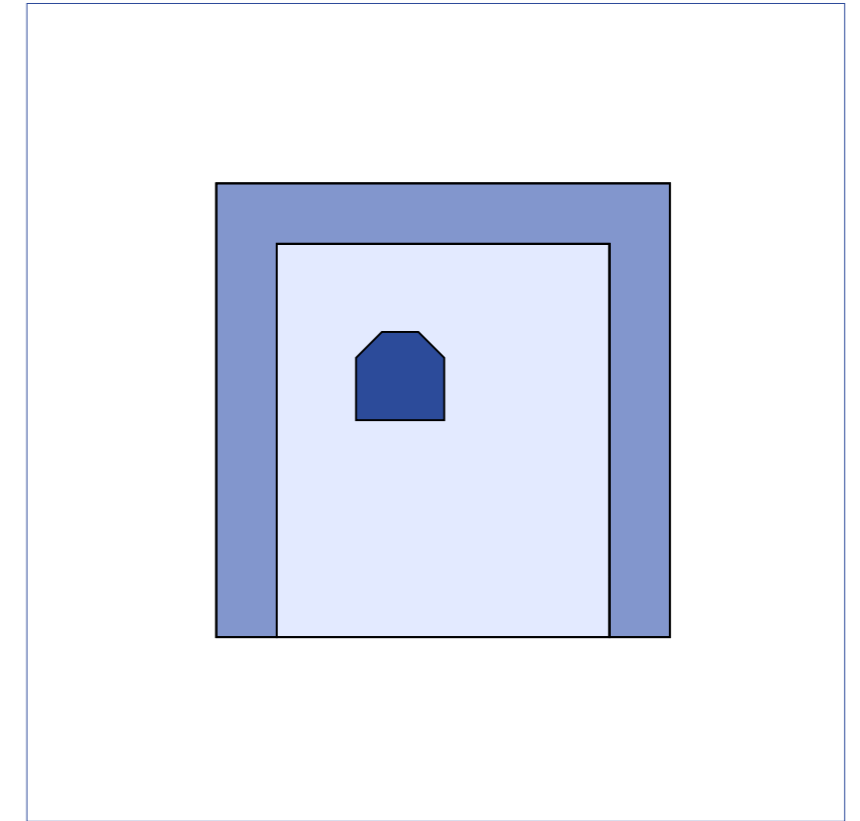

PERMEABILITY OF THE FACADE

- 1 open facade
- 3 filter facades

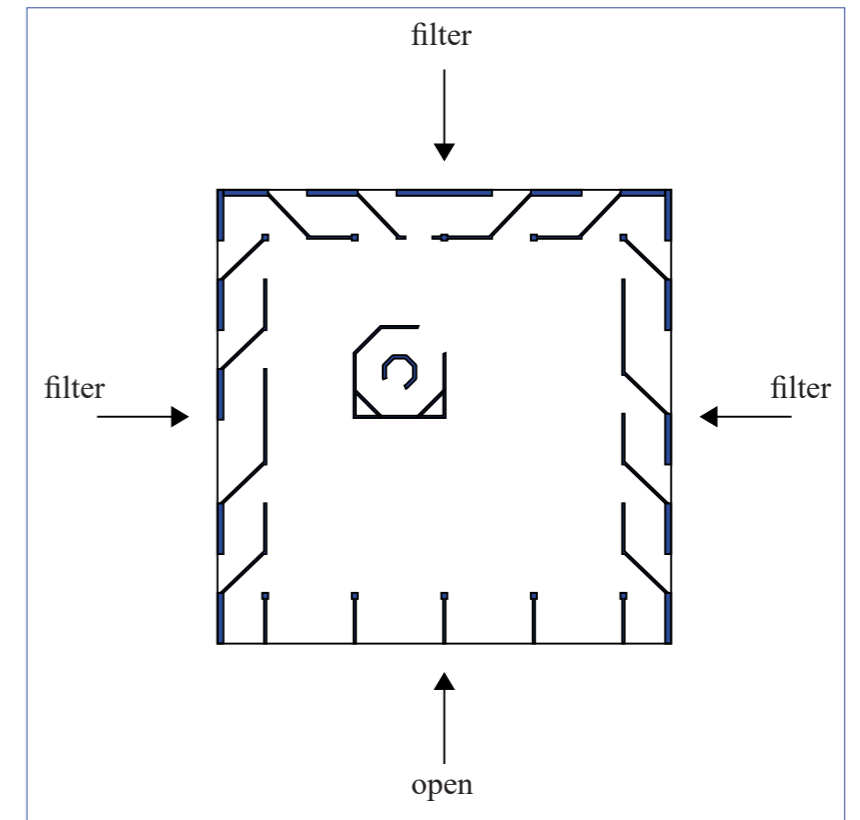

CONSTRUCTION

- Column structure with inner stiffening walls and bathroom
- Structure allows for rearrangement of partition/diagonal walls

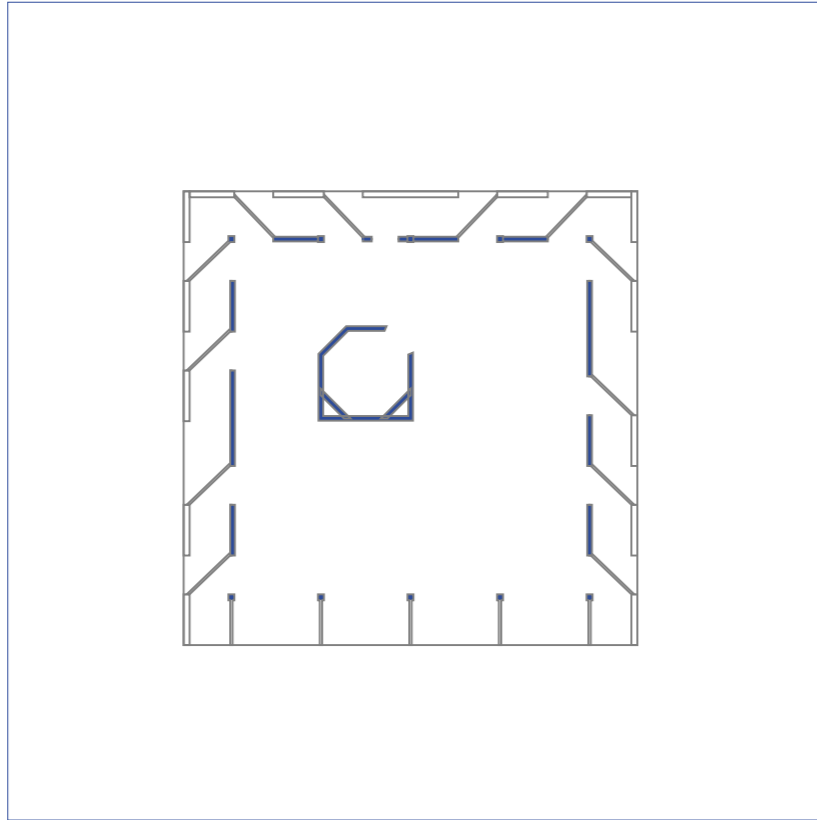

NICHE

- Serve several functions
- 1- Capture and guide the light into to the common spaces

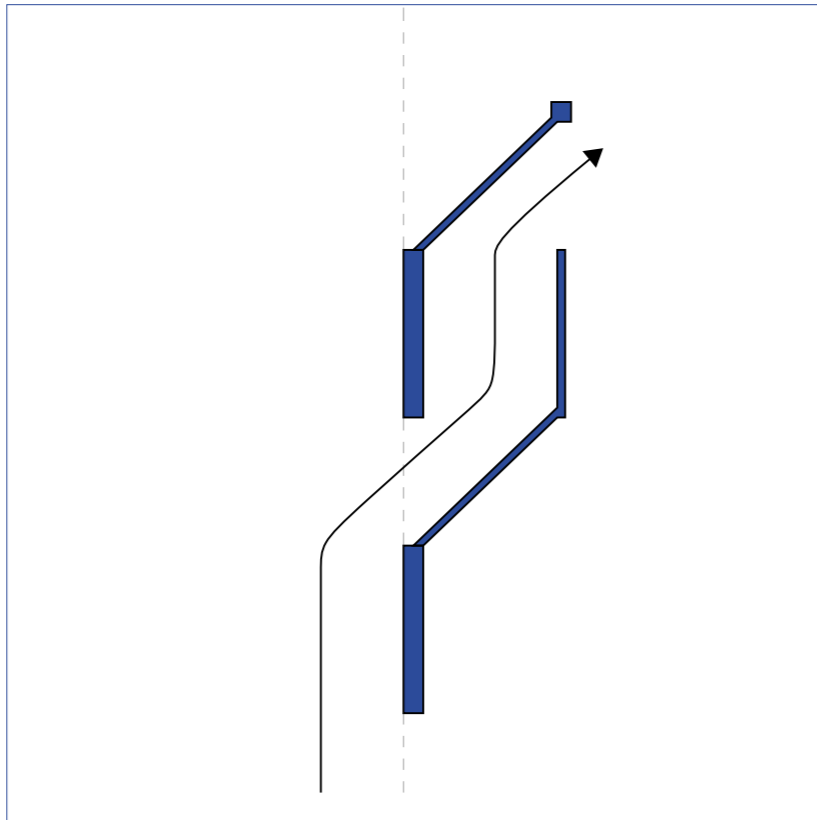

NICHE

- 2- Create ambient light at certain hours of the day

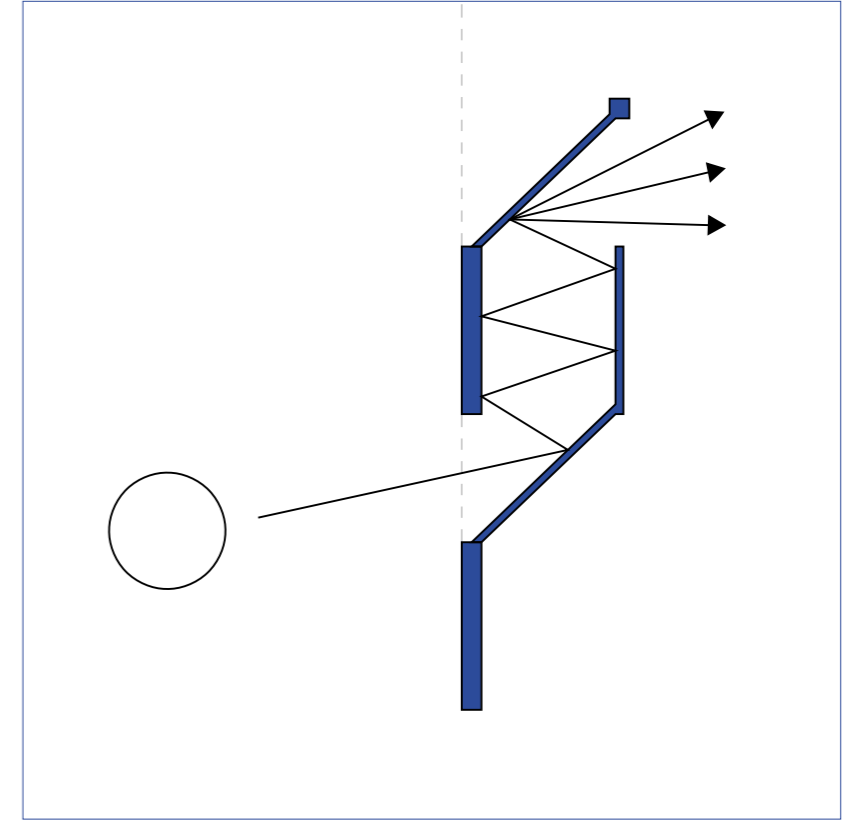

NICHE

- 3- Filter the cold light through reflection within the niche before spreading filtered warm light into common spaces

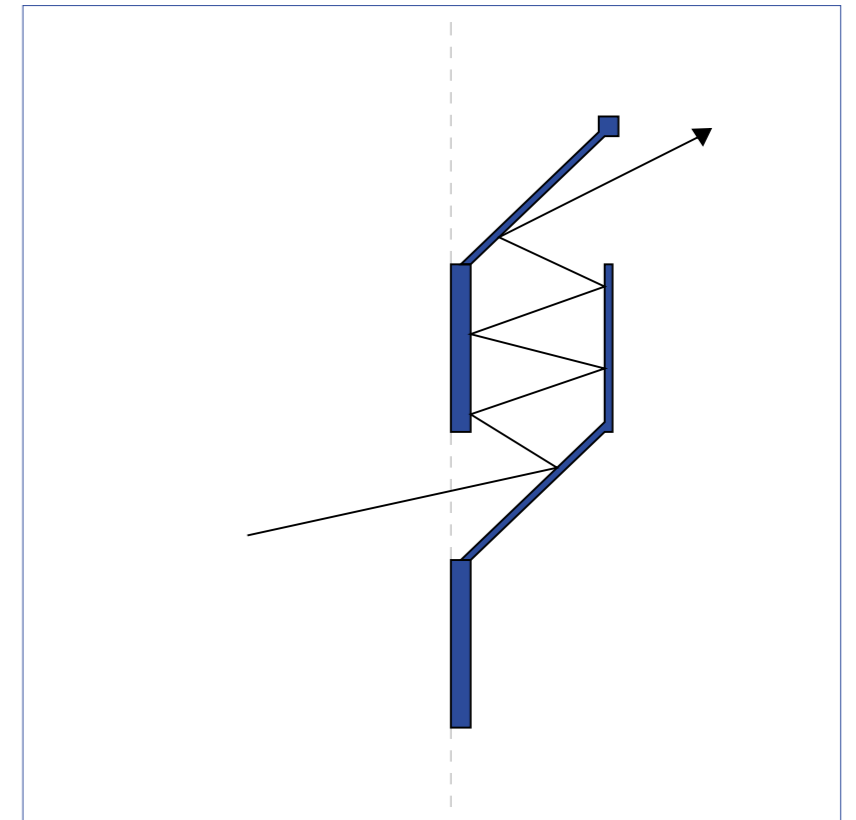

4.2 - Diagrams

HEIGHT

- 1 storey high dwelling
- Prevents long shadows
- Part of the building that is elevated is mostly covered in glass for visual transparency

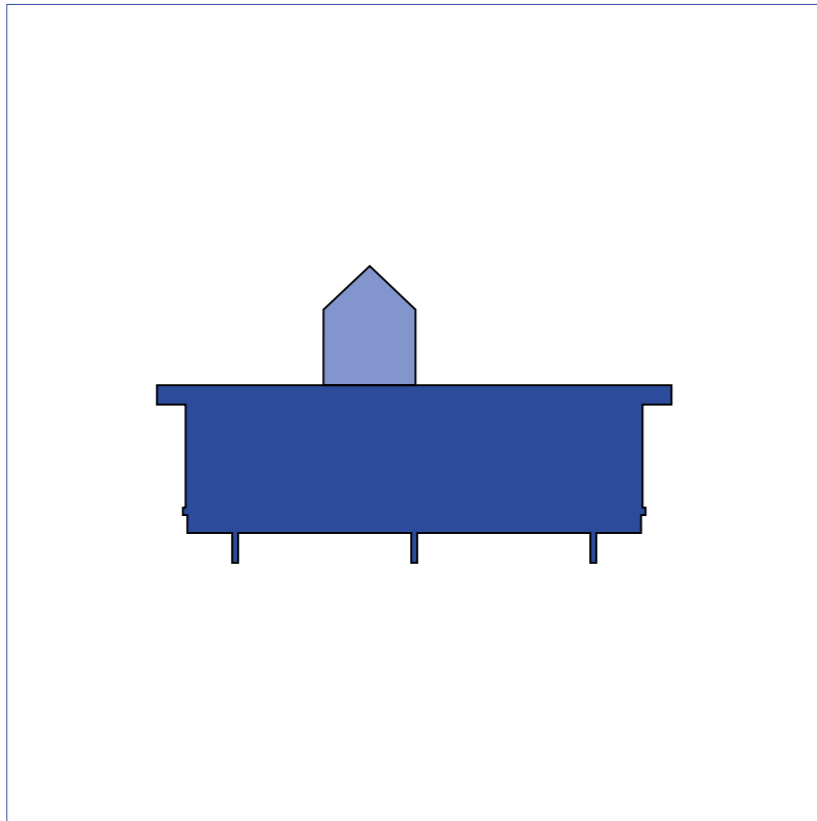

STAIR SYSTEM

- Filter layer has 3m high ceiling
- Common spaces 2.4m
- Bathroom 8m
- Stair system allows to capture greater amount of light within the niches and prevents strong light from entering the common spaces
- Open facade captures all light during dark period

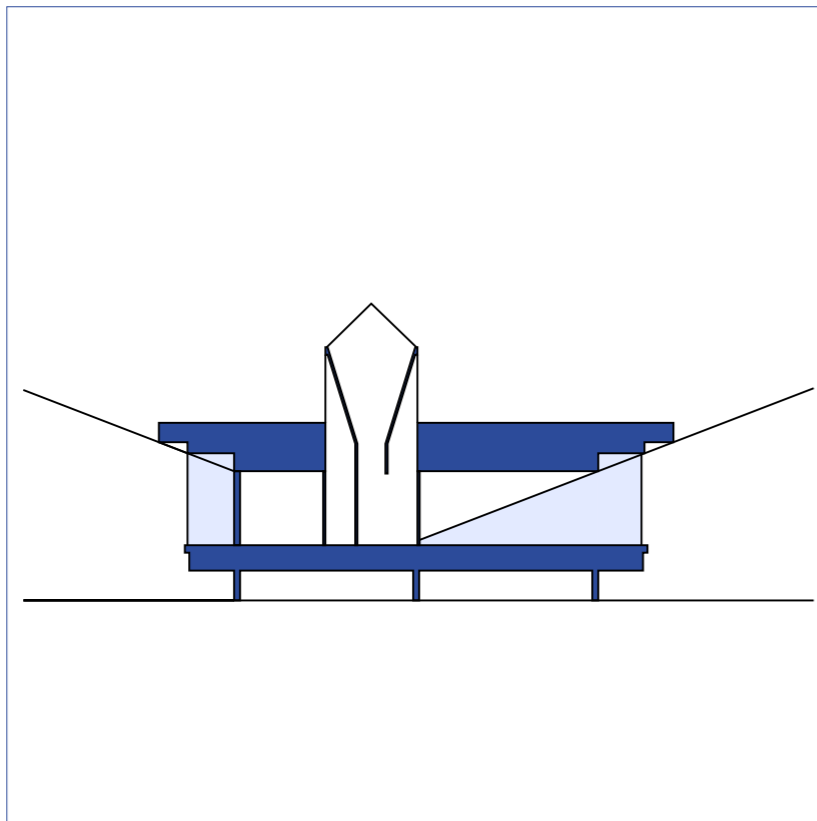

4.2 - Diagrams

WINDOWS

- Windows from slab to slab to capture sky light and reflection from the snow on the ground

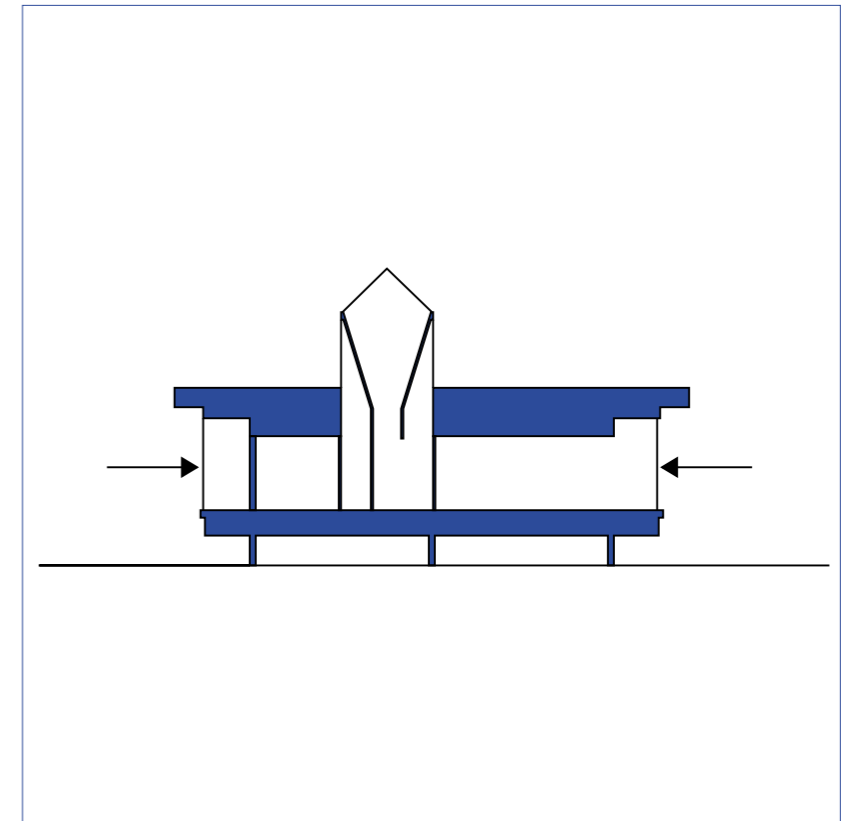

CANTILEVER ROOF

- Reflects light from the snow inside the building

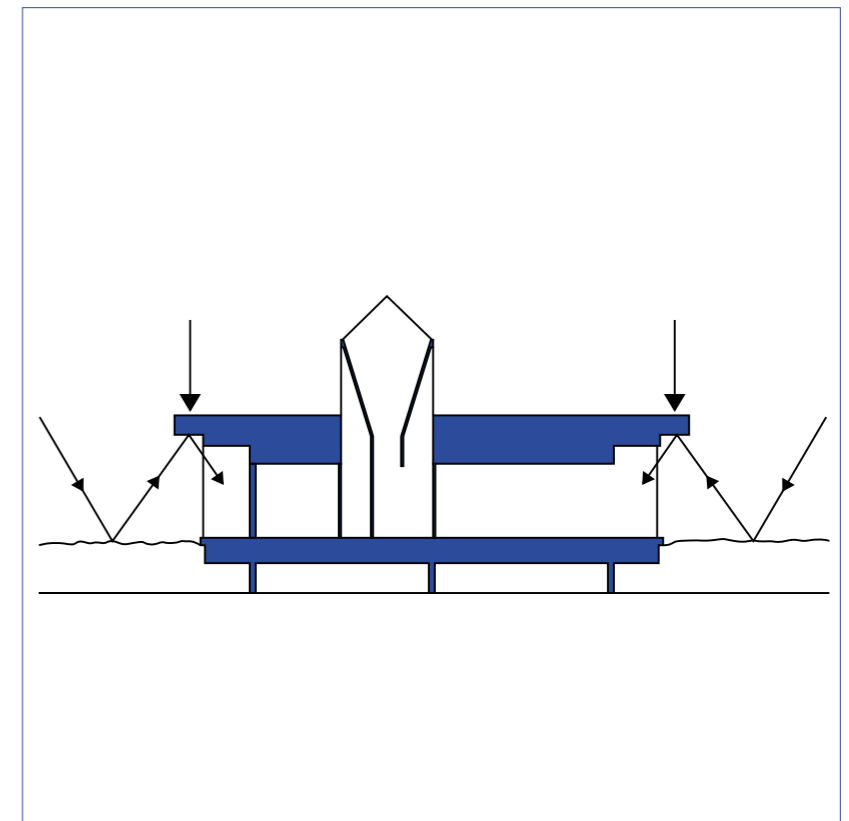

BATHROOM HEIGHT

- Due to amount of snow

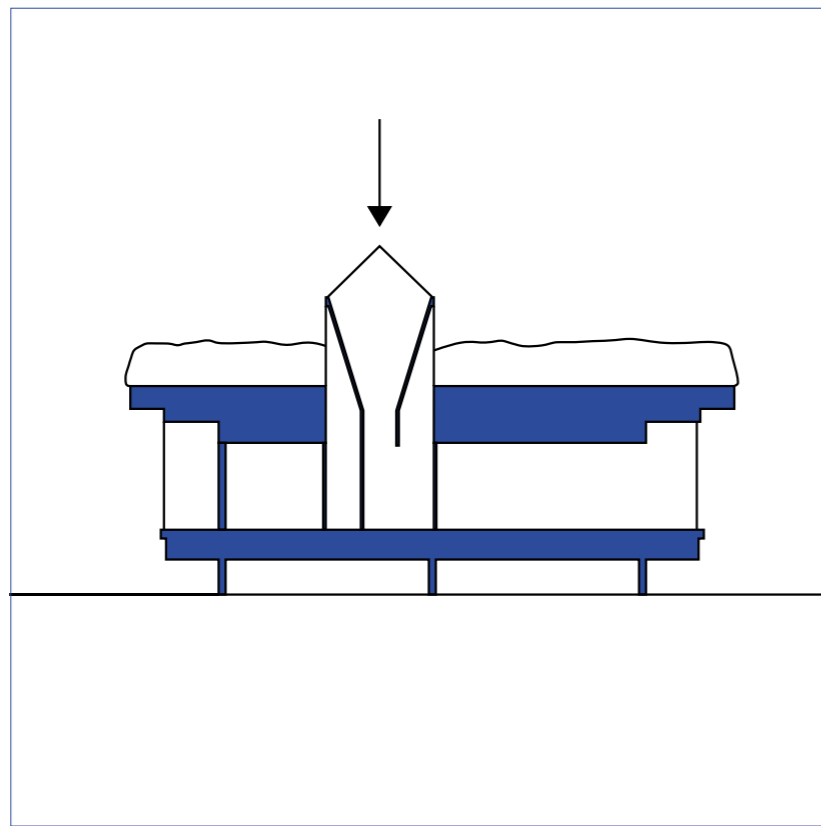

BATHROOM SHAPE

- Horizontal light from 360 degrees angle spread down to floor area
- Centered shower allows both to observe light and capture skylight

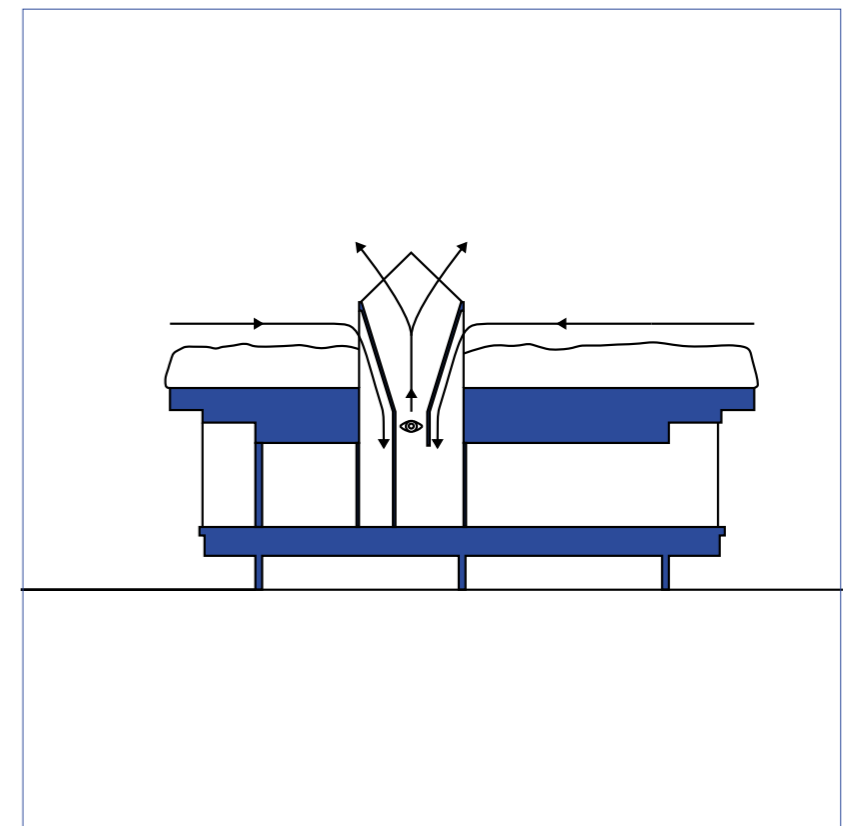

4.3 - Construction

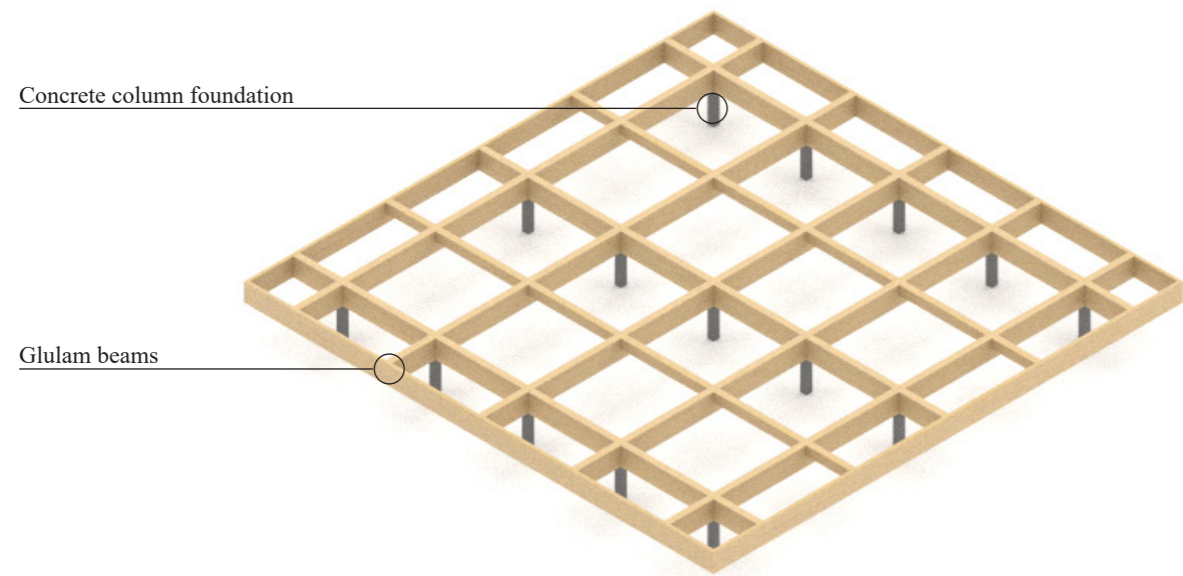

1

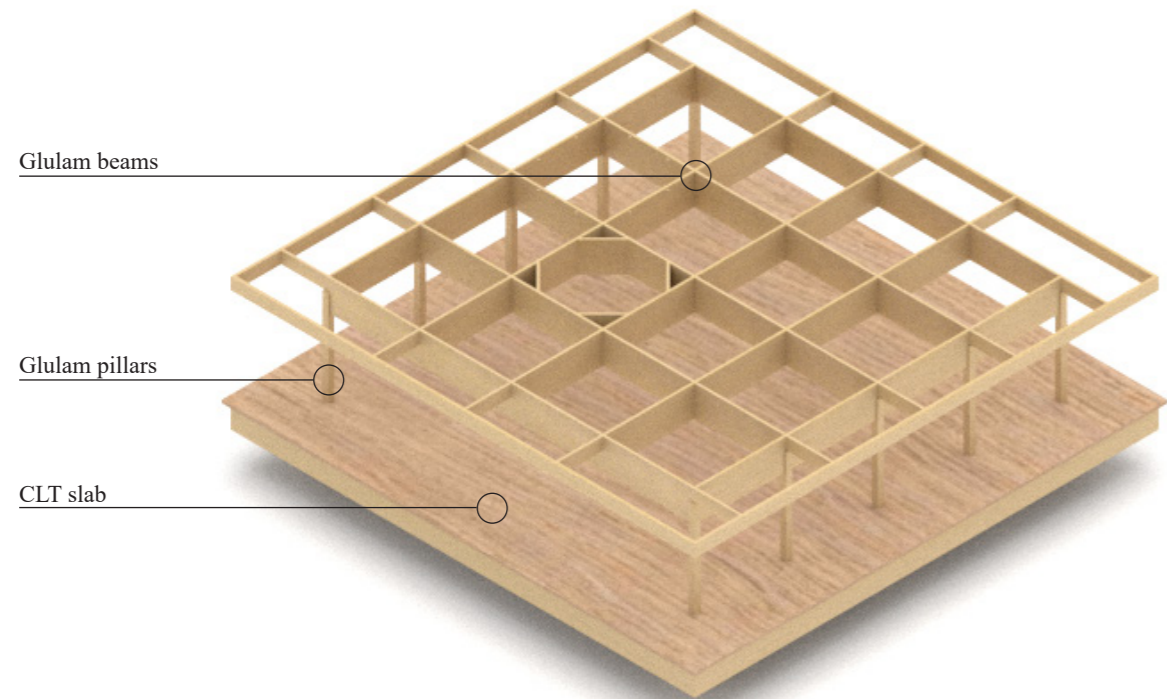

2

4.3 - Construction

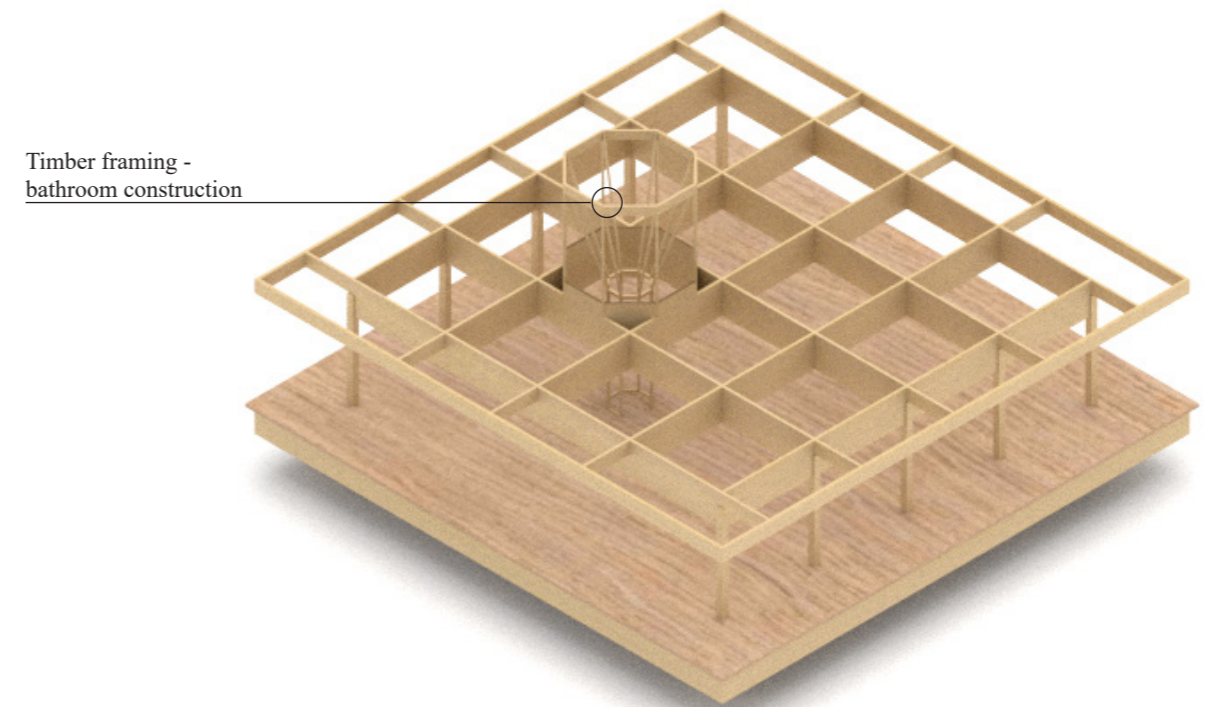

3

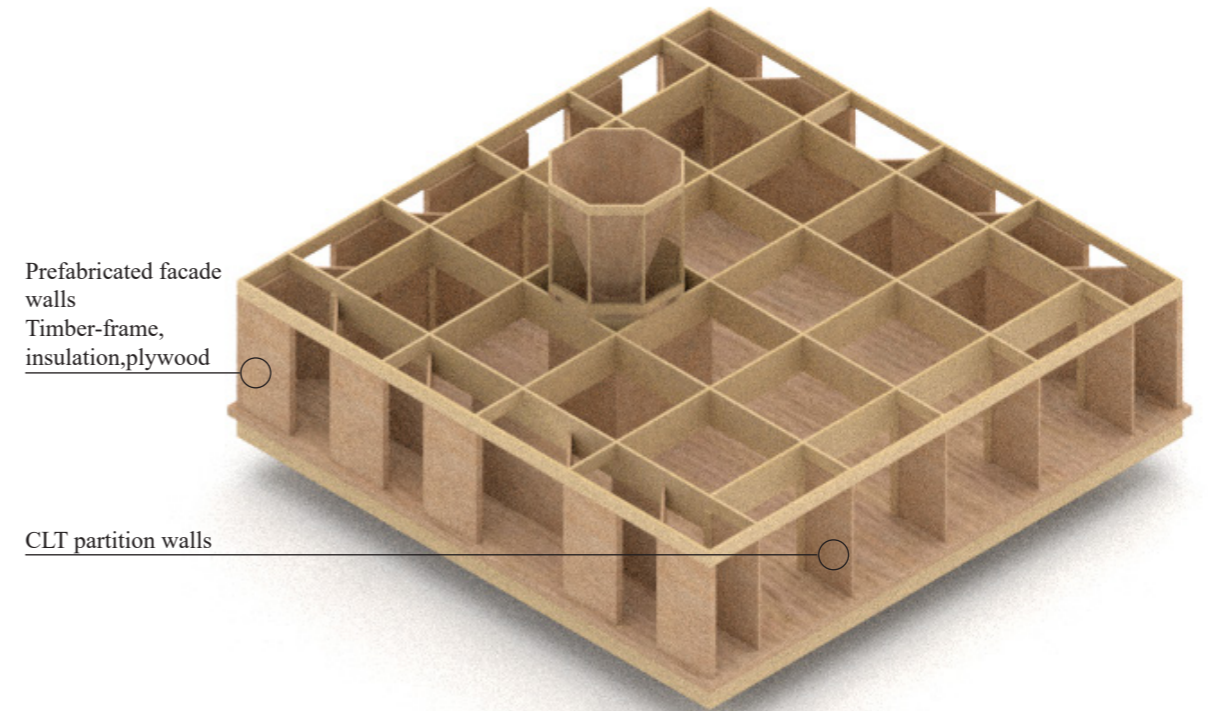

4

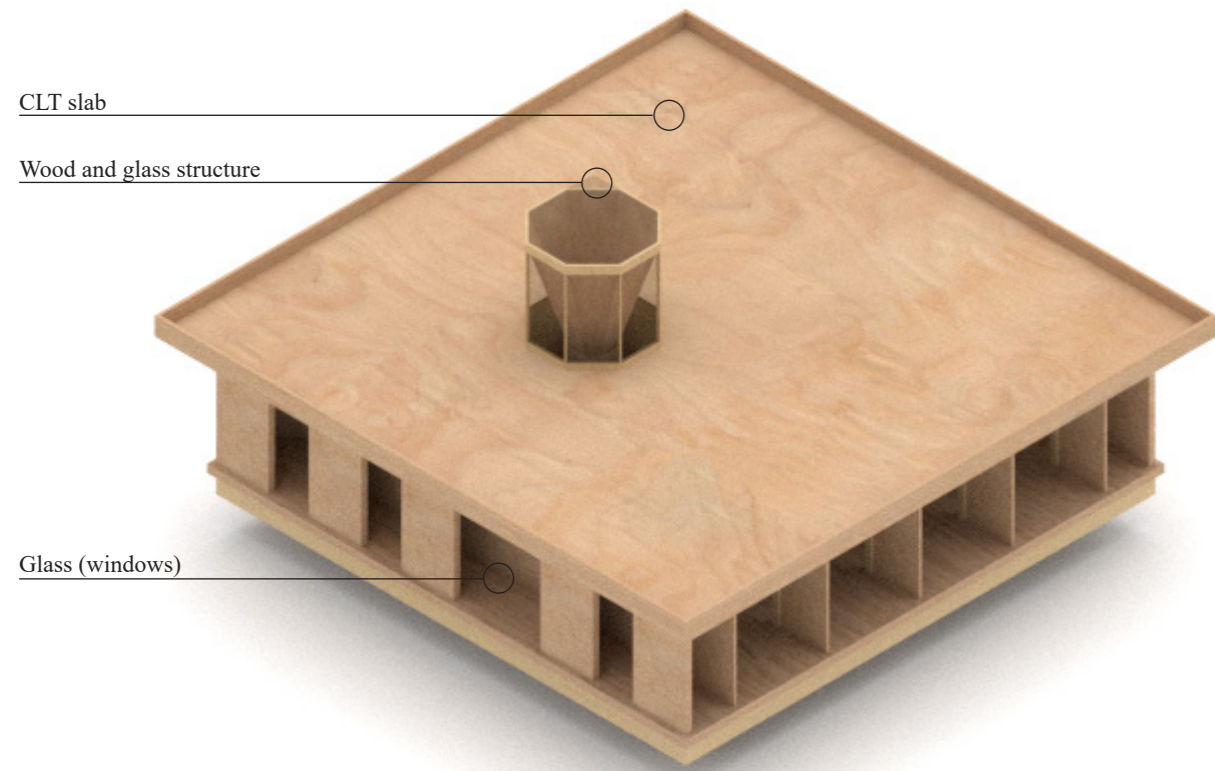

5

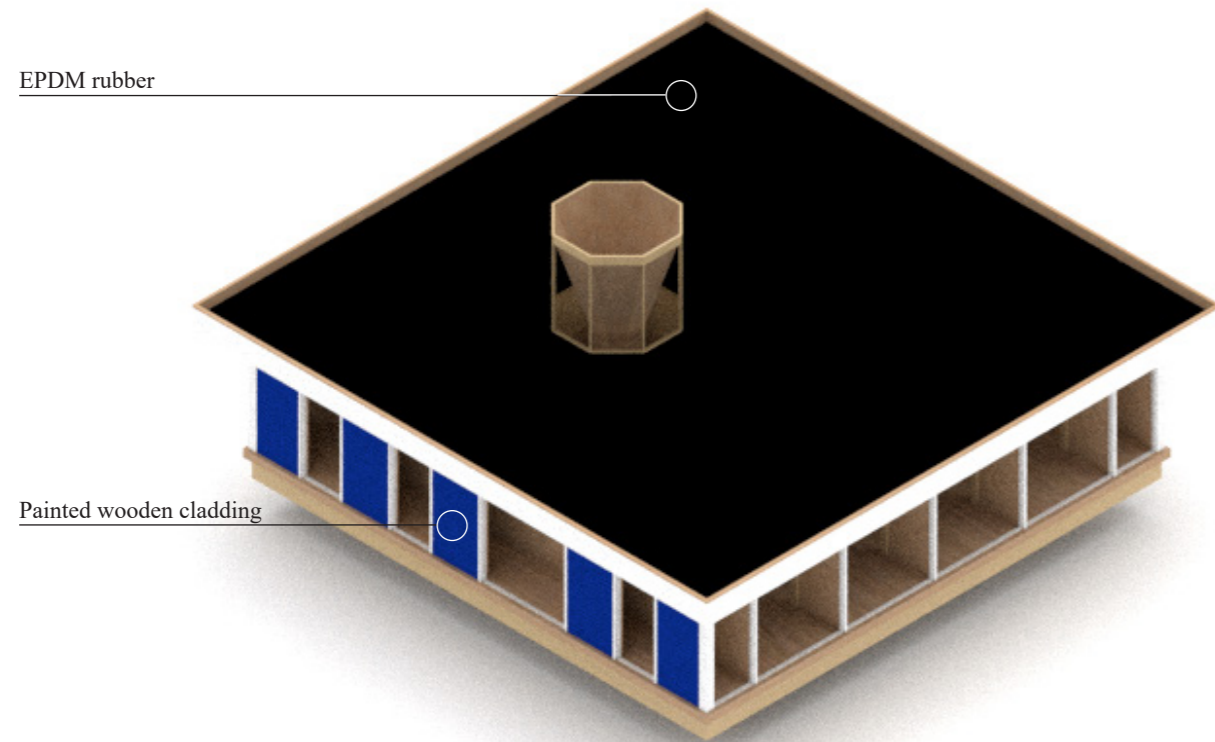

6

CONSTRUCTION PLAN

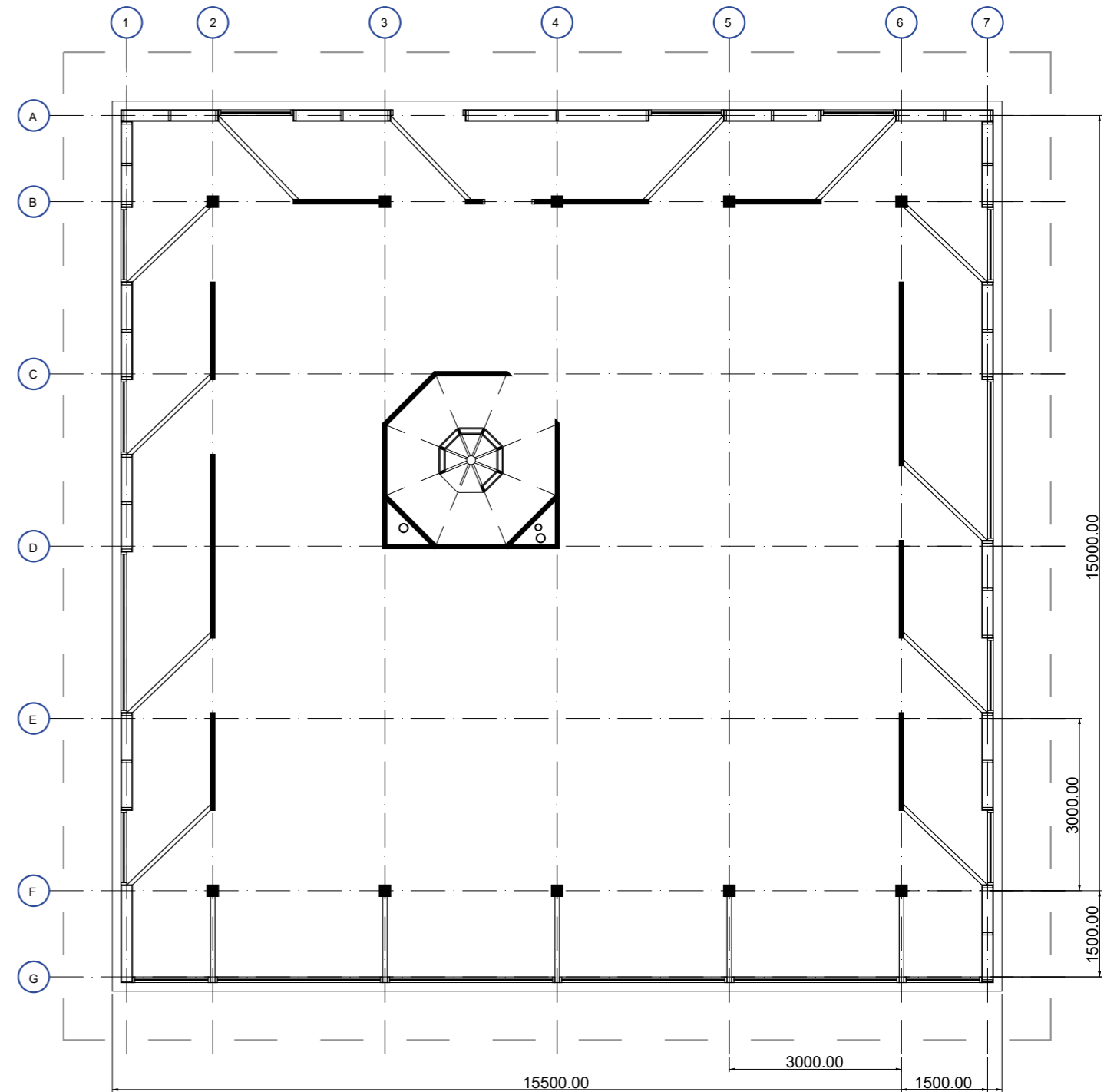

SCALE 1:100

SECTION

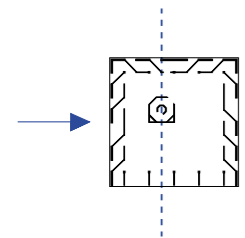
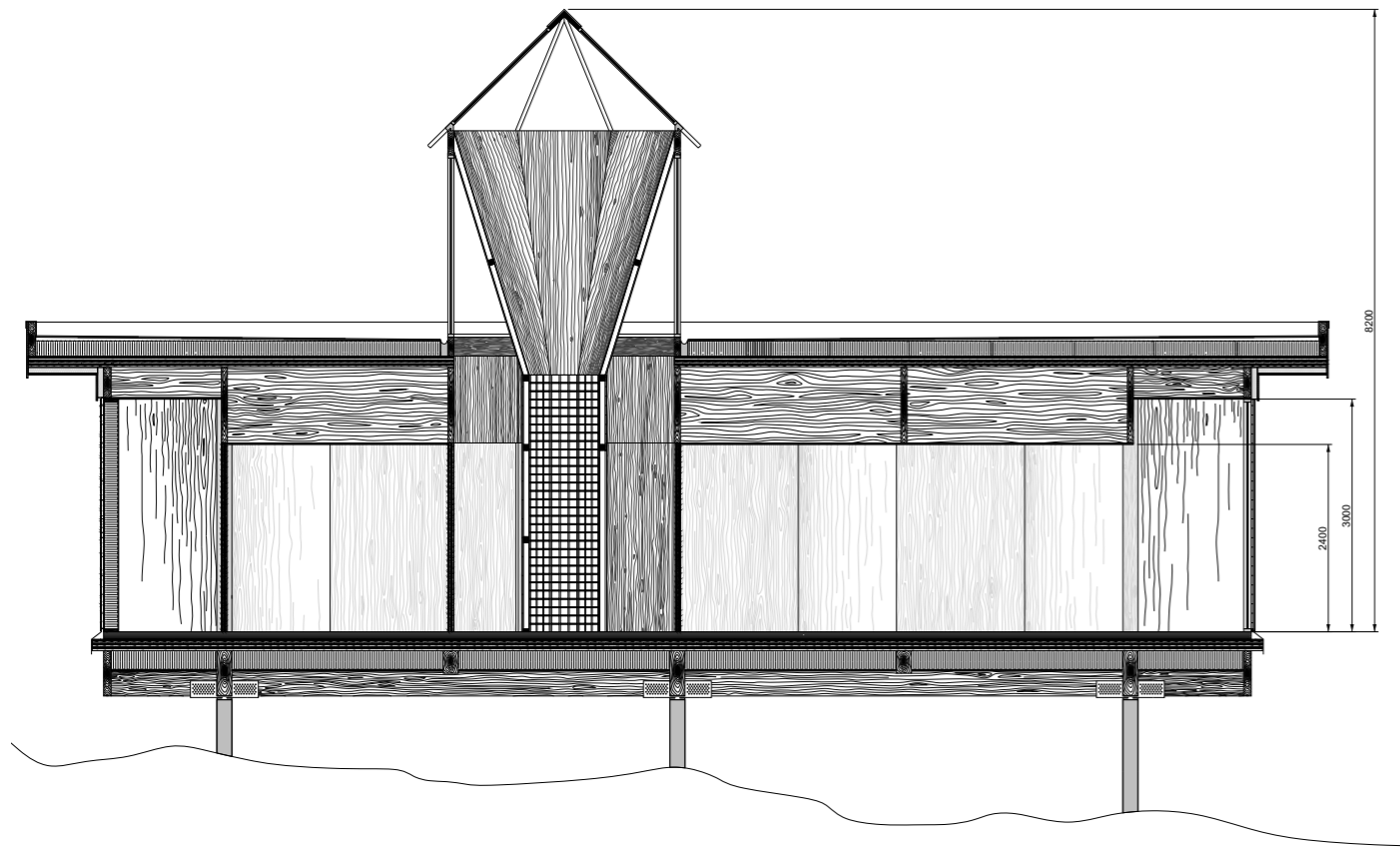

SCALE 1:100

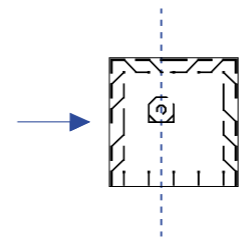
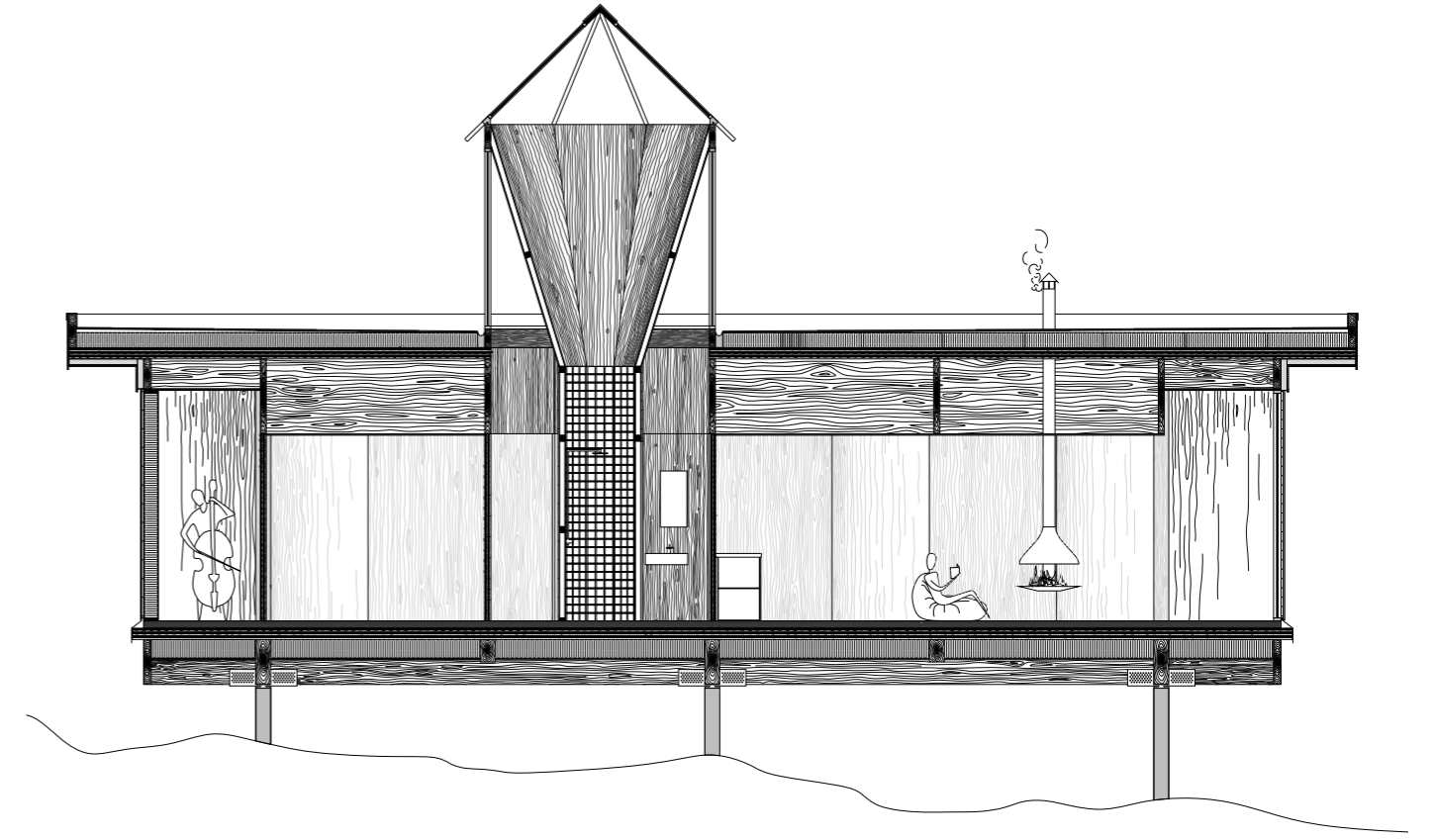

SCALE 1:100

PLAN - IMAGINARY LIFE SCENE

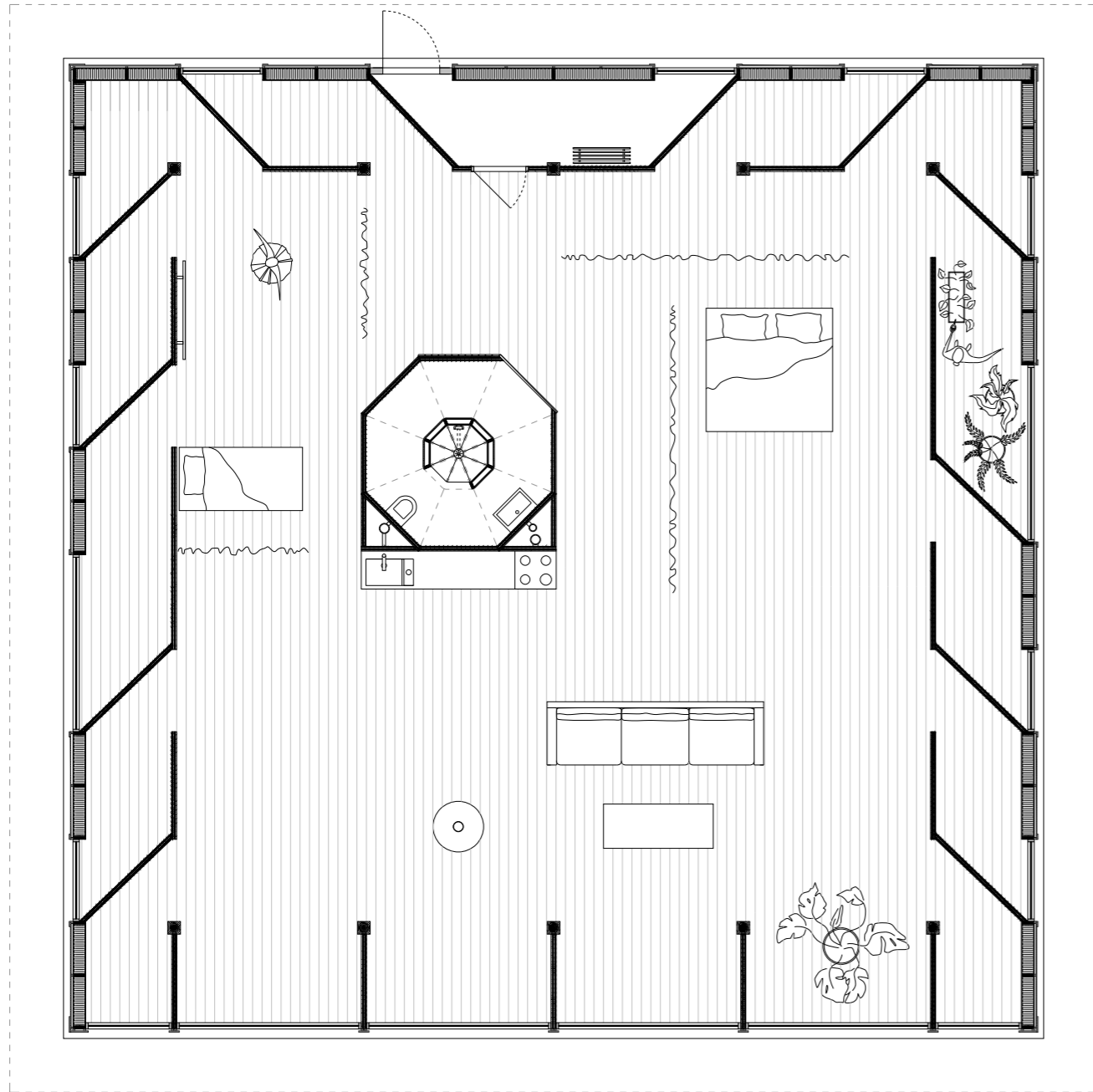

SCALE 1:100

PLAN - WINTER - SOLSTICE (MERIDIAN)

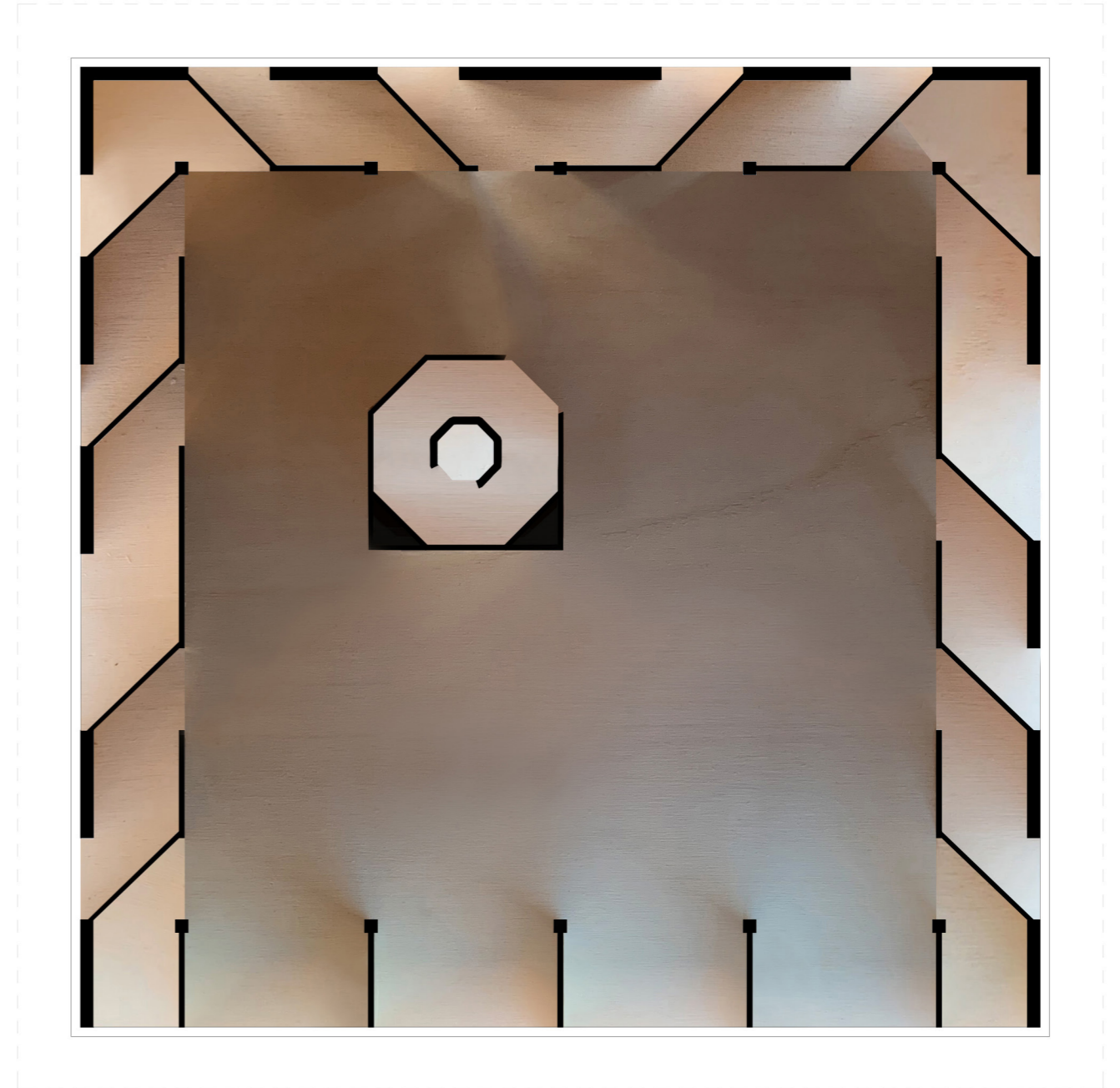

SCALE 1:100

PLAN - SUMMER - SOLSTICE (MERIDIAN)

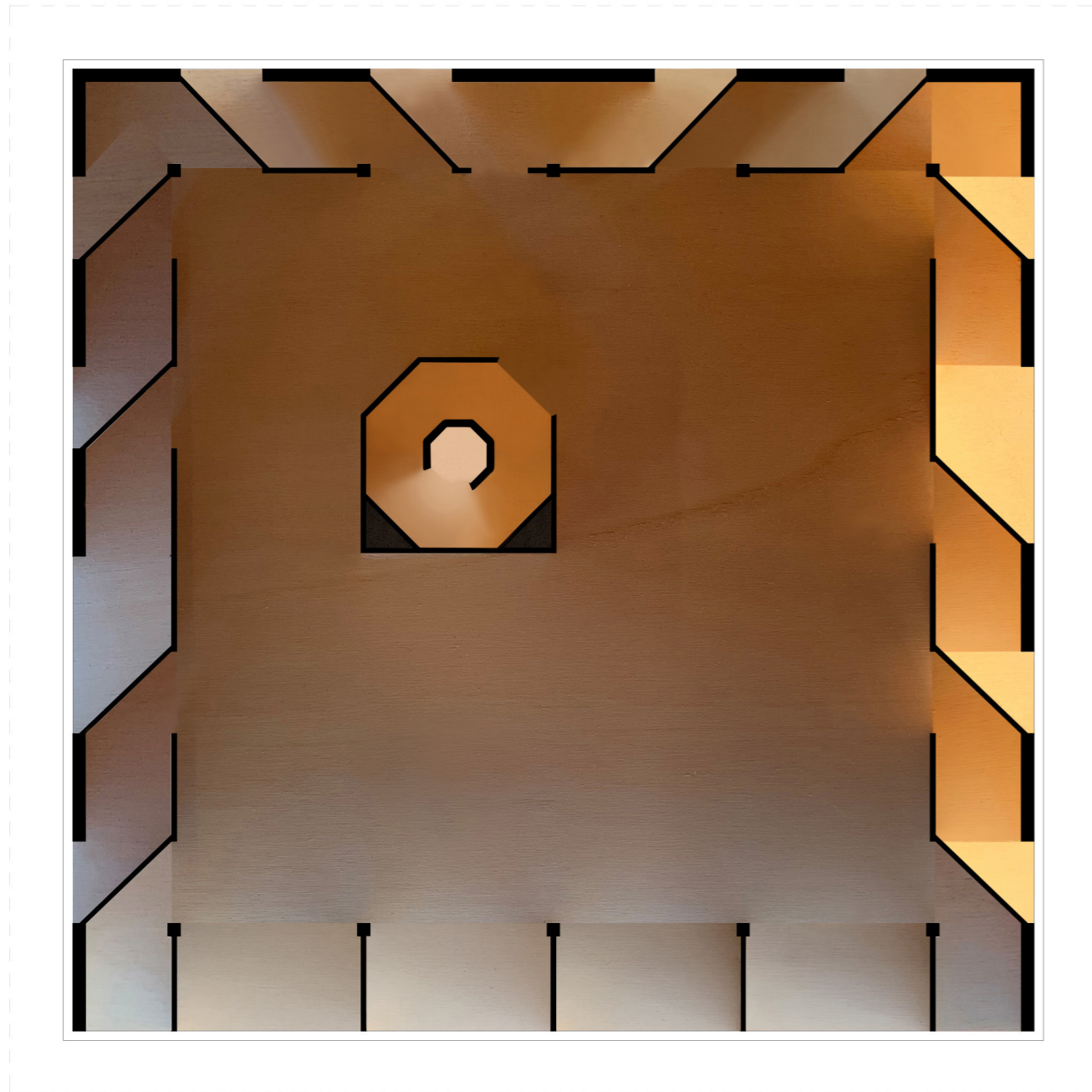

SCALE 1:100

4.6 - Specific site

PICTURE OF THE PROJECT ON RANDOMLY CHOSEN SITE IN TROMSØ

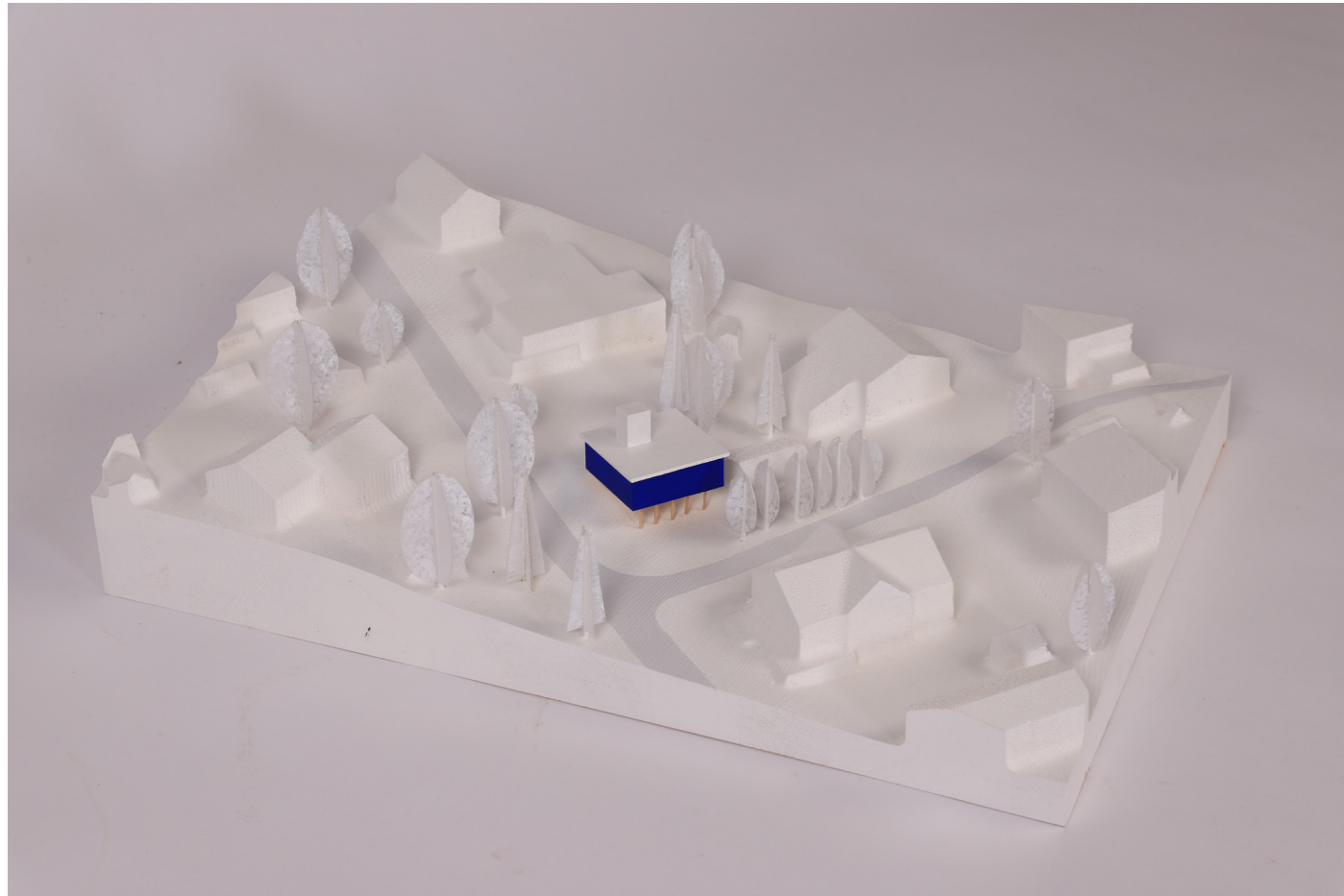

MODEL SCALE 1:200

4.6 - Specific site

PICTURE OF THE PROJECT ON RANDOMLY CHOSEN SITE IN TROMSØ

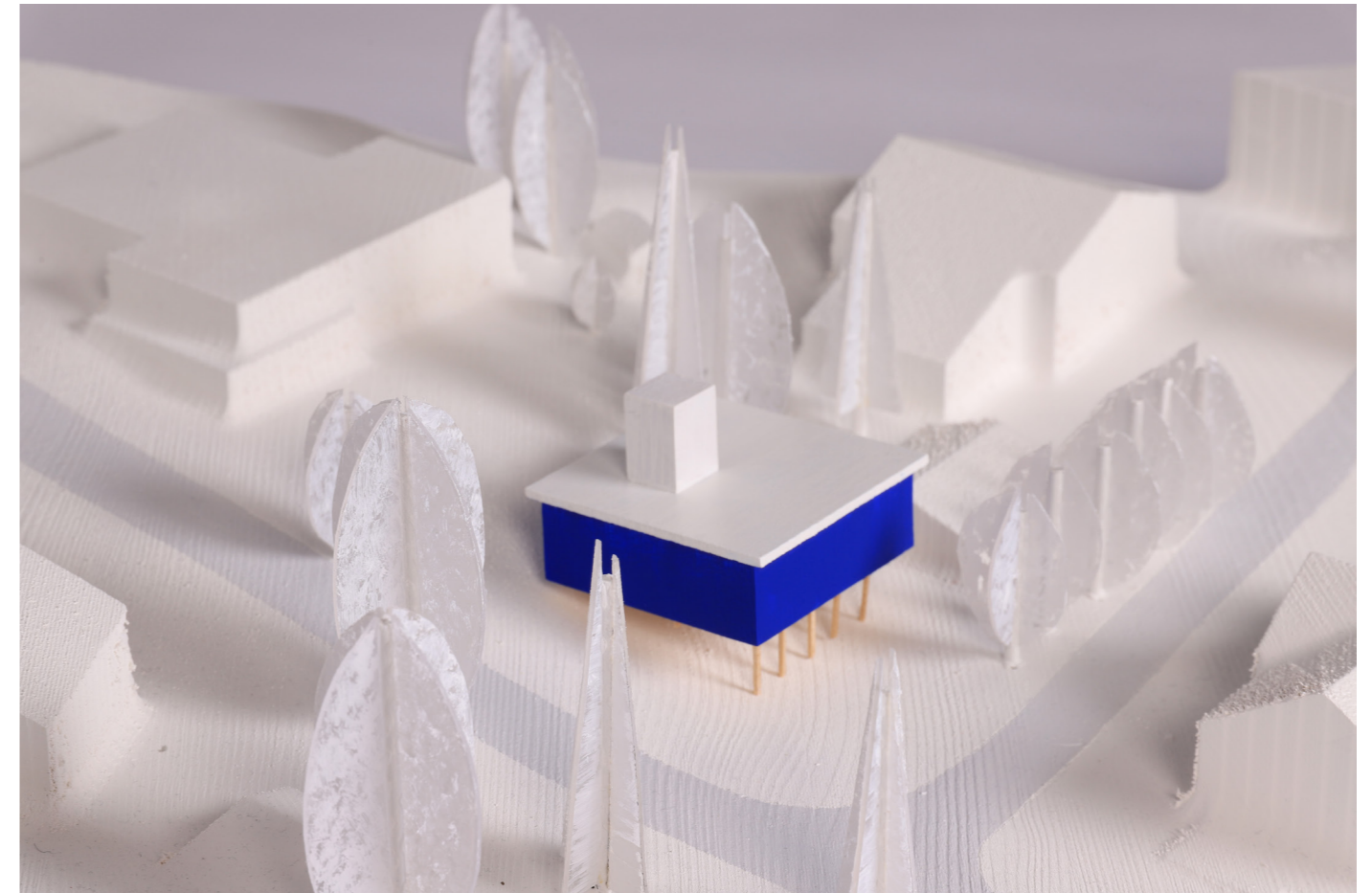

MODEL SCALE 1:200



KITCHEN/LIVING - PINK LIGHT +
SNOW REFLECTION



KITCHEN/LIVING- PINK LIGHT +
SNOW REFLECTION



LIVING - OVERCAST DAY + SNOW REFLECTION



BATHROOM - OVERCAST DAY + SNOW REFLECTION



BATHROOM- SUNNY DAY

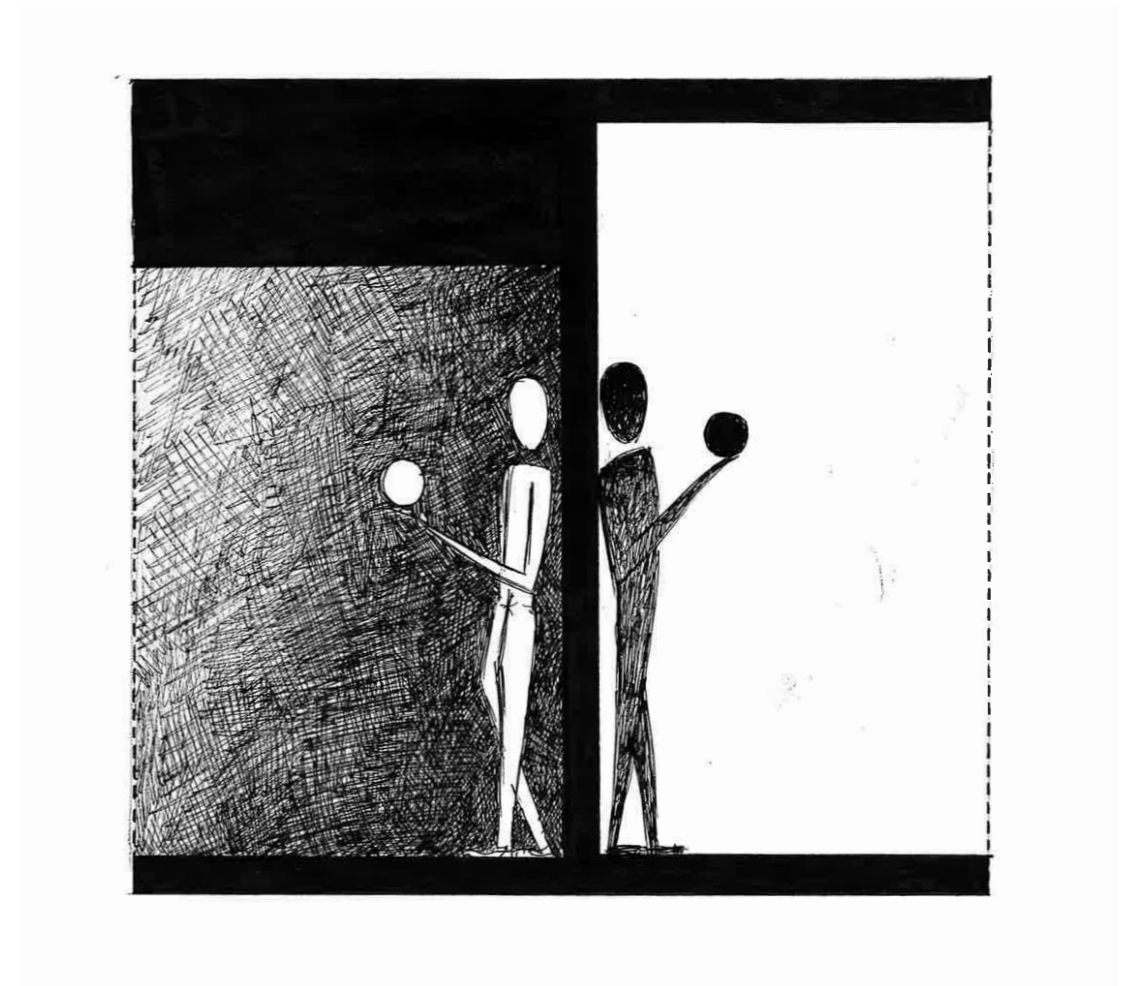

I'M IN SEARCH OF THE LIGHT - I'M IN SEARCH OF THE DARK



LIVING - SUNNY DAY



LIVING - SUNNY DAY (AMBIENT LIGHT)



LIVING - SUNNY DAY (AMBIENT LIGHT, DARKER)



LIVING - SUNNY DAY (AMBIENT LIGHT, DARKER)

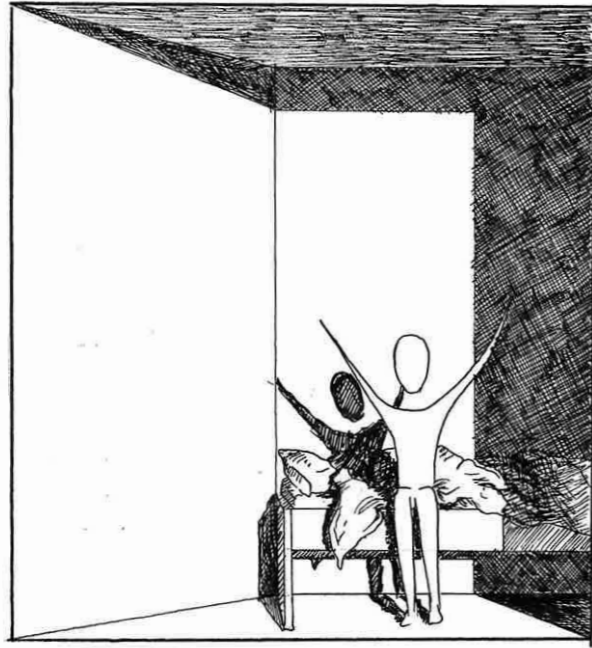

SURVEY: FAVORITE ROOM AND WHY?
<<BEDROOM: WHERE ONE GET DIRECT LIGHT IN
THE MORNING, DURING SUMMER>>



NICHE - SUNNY DAY



NICHE - OVERCAST DAY + SNOW
REFLECTION



LIVING/KITCHEN - SUNNY DAY
(MIDNIGHTSUN)

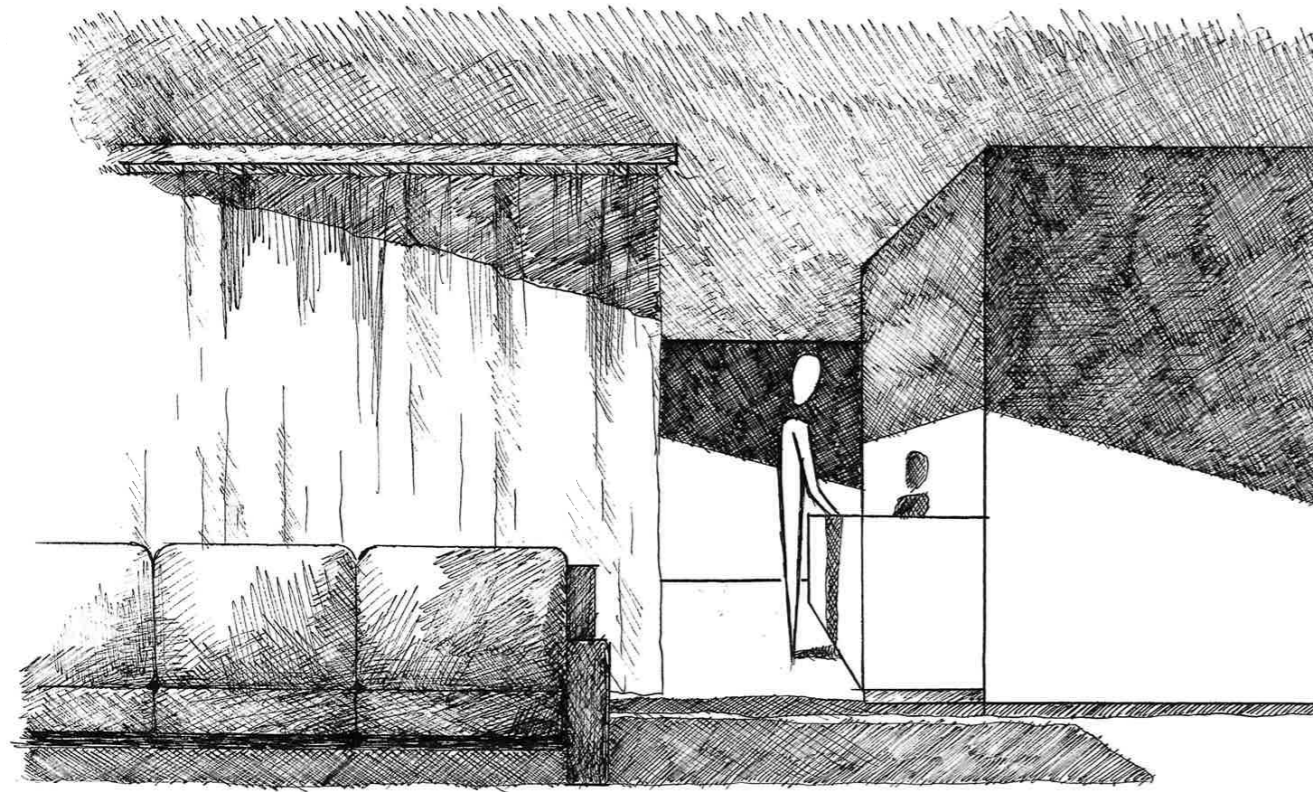

SURVEY: FAVORITE ROOM AND WHY?
<<LIVING+KITCHEN: BRIGHT, VIEW, SPACIOUS>>



LIVING/KITCHEN - SUNNY DAY



LIVING/KITCHEN - SUNNY DAY



LIVING/ENTRANCE - SUN
RETURNING BACK AFTER DARK
PERIOD

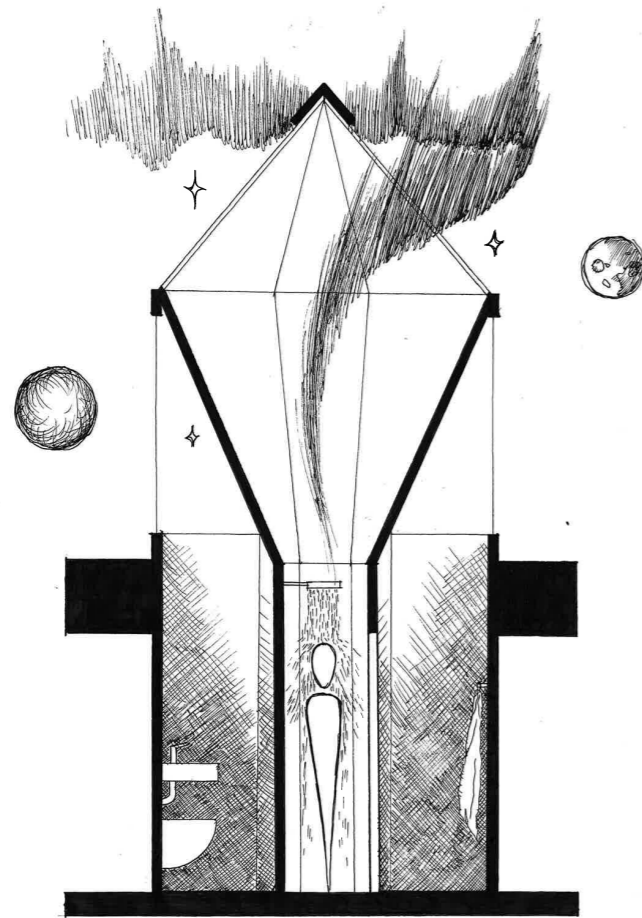

SURVEY: LEAST FAVORITE ROOM AND WHY?
<<BATHROOM: LITTLE LIGHT, NO WINDOWS>>



SHOWER - BATHROOM - NORTHERN
LIGHTS



"DWELLING IN LIGHT"

ACKNOWLEDGEMENTS

I want to conclude by saying thank you to:

My supervisors Lisbeth Funck and Matthew Anderson for an amazing journey through these last semesters. All the interesting table talks, discussions during the reviews and last but not least the way you work.

The external supervisors: Christine Fontaine, Dagur Eggertsson and Lone Sjøli for constructive criticism to the project during the midterm reviews.

People of Tromsø. For showing me your interest in my project. Inviting me to your homes, workplaces, sharing stories and knowledge, making this whole trip fun. I'm beyond grateful for all the warmth I received there.

The professionals I have met and had interviews/dialog with. That has brought me closer to understand the way architecture is practised in the arctic.

Sakari Ekko for all the help you have given me in understanding how sun simulators work and can be built.

My partner, family and friends for being supportive, calling and keeping the spirit up.

Workshop staff for help and tips on how produce parts for all my models.

Dedicated to my mother and grandmother (Mimmi) for giving me this opportunity and inspiration for the project.